

2021
2022

OLSA *Parts*



CATALOGO ILLUMINAZIONE E SPECCHI LIGHTING AND MIRRORS CATALOGUE

INDICE | INDEX

| | |
|--|-----|
| FANALI ANTERIORI PER AUTOVETTURE <i>FRONT LAMPS FOR CARS</i> | 6 |
| FANALI LATERALI PER AUTOVETTURE <i>SIDE LAMPS FOR CARS</i> | 14 |
| FANALI POSTERIORI PER AUTOVETTURE <i>REAR LAMPS FOR CARS</i> | 37 |
| FANALI TARGA PER AUTOVETTURE <i>NUMBER PLATE LIGHTS FOR CARS</i> | 82 |
| CATADIOTTRI PER AUTOVETTURE <i>REFLECTORS FOR CARS</i> | 89 |
| PLAFONIERE PER AUTOVETTURE <i>DOME LAMPS FOR CARS</i> | 93 |
| PROIETTORI PER AUTOVETTURE <i>HEADLAMPS FOR CARS</i> | 94 |
| FENDINEBBIA PER AUTOVETTURE <i>FOG LAMPS FOR CARS</i> | 98 |
| FANALI ANTERIORI PER AUTOCARRI <i>FRONT LAMPS FOR TRUCKS</i> | 102 |
| FANALI LATERALI PER AUTOCARRI <i>SIDE LAMPS FOR TRUCKS</i> | 114 |
| FANALI INGOMBRO PER AUTOCARRI <i>SIDE MARKERS FOR TRUCKS</i> | 129 |
| FANALI POSTERIORI PER AUTOCARRI <i>REAR LAMPS FOR TRUCKS</i> | 165 |
| PROIETTORI PER AUTOCARRI <i>HEADLAMPS FOR TRUCKS</i> | 226 |
| FENDINEBBIA PER AUTOCARRI <i>FOG LAMPS FOR TRUCKS</i> | 229 |
| FANALI TARGA PER AUTOCARRI <i>NUMBER PLATE LIGHTS FOR TRUCKS</i> | 231 |
| CATADIOTTRI PER AUTOCARRI <i>REFLECTORS FOR TRUCKS</i> | 236 |
| PLAFONIERE PER AUTOCARRI <i>DOME LAMPS FOR TRUCKS</i> | 240 |
| LAMPADA ROTANTE <i>REVOLVING BEACON</i> | 242 |
| ARTICOLI VARI <i>DIFFERENT KIND OF ARTICLES</i> | 247 |
| PANNELLI SEGNALETICI <i>SAFETY DEVICES</i> | 255 |
| SPIRALI MOTRICE RIMORCHIO <i>TRAILERS SPIRAL CABLES</i> | 259 |
| RETROVISORI <i>MIRRORS</i> | 264 |
| INDICE PER CODICE <i>CODE INDEX</i> | 276 |
| RIFERIMENTI ORIGINALI <i>ORIGINAL PARTS NUMBERS</i> | 288 |
| CONDIZIONI GENERALI DI VENDITA <i>GENERAL SALES CONDITIONS TERMS</i> | 301 |

OLSA PARTS è una società del Gruppo OLSA.

OLSA S.p.a. è un'azienda nata negli anni '40 del secolo scorso e dalla sua nascita è attiva nella produzione di fanaleria ed elementi di illuminazione per autoveicoli ed autocarri (fanali posteriori, plafoniere, fanali laterali, fanali targa etc.). Il quartier generale di OLSA è a Rivoli (Torino), con due stabilimenti produttivi in Italia (entrambi a Moncalieri) ed ulteriori stabilimenti in Polonia, Brasile, Cina, Messico e Turchia. Inoltre, il Gruppo ha un ufficio tecnico e commerciale in Germania.

Ad oggi, il Gruppo occupa più di 3.000 persone, di cui 650 in Italia.

In Italia, negli uffici del reparto di R&D, lavorano più di 120 ingegneri.

I Clienti del Gruppo OLSA sono tra i più importanti costruttori di autoveicoli al mondo: i principali clienti sono i produttori tedeschi, il gruppo Volkswagen (VW, Audi, Skoda, Porsche), BMW, GM e Mercedes. Oltre a questi, OLSA fornisce FCA, i produttori francesi ed i giapponesi, tra i quali Suzuki e Toyota.

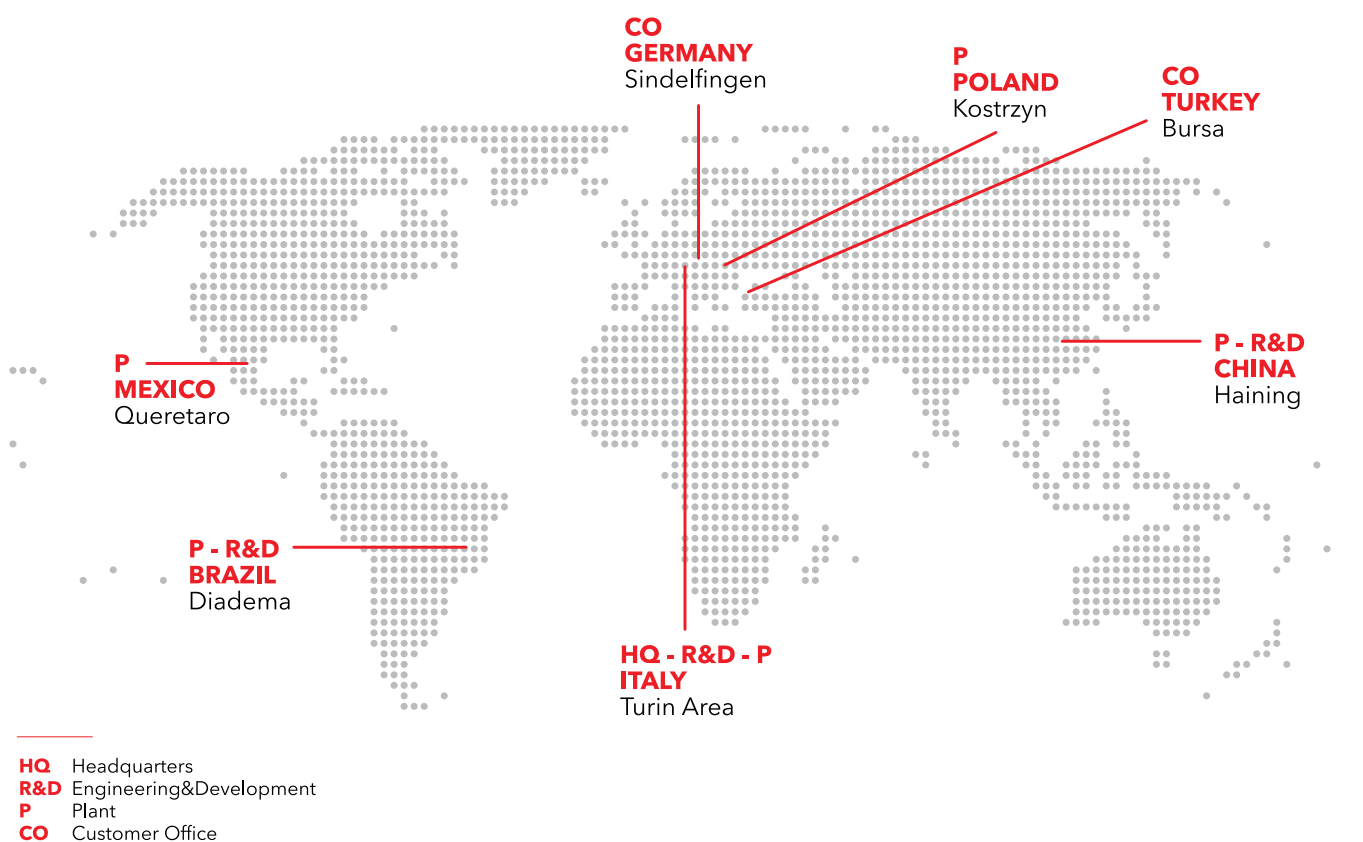
**OLSA PARTS is a company member of the OLSA Group.**

OLSA Group was born in the 40's and has been producing lighting for cars and trucks (rear lamps, dome lamps, number plate lights...) for more than 70 years. OLSA's headquarters are in Rivoli (Turin), with two production plants in Italy (Moncalieri) and others in Poland, Brazil, China, Mexico and Turkey. Moreover, OLSA also has technical and commercial offices in Germany.

As of today, OLSA Group has more than 3.000 employees of which more than 650 in Italy. In the Italian R&D department are now working more than 120 engineers.

OLSA Group's customers are among the most important car makers in the world: its main customers are in Germany, such as Volkswagen Group (with VW, Audi, Skoda, Porsche brands), BMW, GM and Mercedes. Moreover, OLSA is supplying FCA Group, the French producers and some Japanese car makers, such as Suzuki and Toyota.

IL PRESENTE CATALOGO SI PREFIGGE LA CORRETTA CLASSIFICAZIONE DELLA PARTE DI RICAMBIO NECESSARIA ALLA RIPARAZIONE DELLA VETTURA ED INDIVIDUA I PRODOTTI/ARTICOLI COMMERCIALIZZATI E DISTRIBUITI DA OLSA PARTS.

I prodotti commercializzati da OLSA Parts rientrano in tre differenti tipologie di prodotto:

- 1) Ricambio originale
- 2) Ricambio di qualità equivalente
- 3) Articoli universali

N.B.: AI FINI DEL PRESENTE CATALOGO, PER RICAMBI ORIGINALI, RICAMBI DI QUALITÀ EQUIVALENTE E ARTICOLI UNIVERSALI DEVONO INTENDERSI PRODOTTI/ARTICOLI RISPONDENTI ALLE DEFINIZIONI DI SEGUITO DATE IN CONFORMITÀ ALL'ATTUALE NORMATIVA VIGENTE IN MATERIA.

AD ECCEZIONE DEI RICAMBI ORIGINALI, LA TIPOLOGIA "RICAMBIO DI QUALITÀ EQUIVALENTE" E "ARTICOLO UNIVERSALE" - PER LA LORO ESATTA INDIVIDUAZIONE - VIENE ESPRESSAMENTE RIPORTATA IN CALCE ALLA RAPPRESENTAZIONE DEL PRODOTTO APPARTENENTE ALLE DUE SUDDETTE CATEGORIE.

SE NON DIVERSAMENTE SPECIFICATO IN CALCE ALL'ARTICOLO, COME AVVIENE PER I RICAMBI DI QUALITÀ EQUIVALENTE E ARTICOLI UNIVERSALI, IL PRODOTTO DEVE INTENDERSI "RICAMBIO ORIGINALE".

In particolare:

1) **RICAMBIO ORIGINALE:** *I ricambi originali mostrati dal presente catalogo e distribuiti da OLSA Parts, sono tutti gli articoli prodotti da OLSA Industriale, nonché ulteriori articoli prodotti da aziende diverse da OLSA Industriale.*

OLSA Industriale e le Aziende diverse dalla stessa i cui prodotti, presenti nel presente catalogo, vengono distribuiti da OLSA Parts, sono costruttori di ricambi originali conformemente alle previsioni di legge vigenti.

Si ricorda che in base alla definizione contenuta nel paragrafo 19, Titolo III, delle Linee Guida al Regolamento UE n. 461/2010, sostitutivo del Regolamento n. 1400/2002 (Legge Monti) per ricambi originali si intendono "LE PARTI O APPARECCHIATURE COSTRUITE CONFORMEMENTE ALLE SPECIFICHE E ALLE NORME DI PRODUZIONE FORNITE DAL COSTRUTTORE DEL VEICOLO.(...) SALVO PROVA CONTRARIA, SI PRESUME CHE LE PARTI COSTITUISCONO PARTI ORIGINALI SE IL COSTRUTTORE DELLE STESSE CERTIFICA CHE ESSE HANNO QUALITÀ EQUIVALENTI AI COMPONENTI UTILIZZATI PER L'ASSEMBLAGGIO DEL VEICOLO IN QUESTIONE E SONO STATE COSTRUITE CONFORMEMENTE ALLE SPECIFICHE ED ALLE NORME DI PRODUZIONE DEL VEICOLO".

2) I **RICAMBI DI QUALITÀ EQUIVALENTE** sono espressamente indicati in calce ad ogni singolo articolo appartenente a questa tipologia e per essi, in base alla definizione contenuta nel paragrafo 20, Titolo III, delle Linee Guida al Regolamento UE n. 461/2010, sostitutivo del Regolamento n. 1400/2002 (Legge Monti), si intendono "I PEZZI DI RICAMBIO DOTATI DI QUALITÀ SUFFICIENTEMENTE ELEVATA, IN MODO CHE IL LORO USO NON COMPROMETTA LA REPUTAZIONE DELLA RETE AUTORIZZATA IN QUESTIONE".

3) Per **ARTICOLI UNIVERSALI**, espressamente indicati in calce ad ogni singolo articolo (a titolo esemplificativo fari lavoro, catadiottri, plafoniere, luci ingombro, pannelli riflettenti, lampade rotanti, ecc...), si intendono tutti i prodotti distribuiti e commercializzati da OLSA Parts "non appartenenti e rientranti nella categoria di ricambio originale e/o di ricambio di qualità equivalente".

Alcuni prodotti facenti parte di tale tipologia sono soggetti ad omologazione ministeriale e/o europea necessaria all'attestazione delle loro prestazioni. **Per tali specifici articoli OLSA Parts distribuisce solo ed esclusivamente prodotti recanti le suddette omologazioni e fornisce ai clienti che ne facciano richiesta la documentazione relativa.**

LE MARCHE CITATE NEL PRESENTE CATALOGO, SONO DI PROPRIETÀ DEI COSTRUTTORI AUTO CUI SI RIFERISCONO.

IL LORO UTILIZZO NEL PRESENTE CATALOGO, COSÌ COME I RIFERIMENTI ORIGINALI INCLUSI (CROSS REFERENCES), HANNO L'UNICO SCOPO DI AIUTARE E AGEVOLARE L'IDENTIFICAZIONE DEL MODELLO D'AUTO SUL QUALE DEVE MONTARSI IL PEZZO DI RICAMBIO. PER IL CORRETTO UTILIZZO DELLE CROSS REFERENCES SI VEDANO LE "AVVERTENZE PER LA CONSULTAZIONE" AL FONDO DEL PRESENTE CATALOGO.

N.B.: NEL PRESENTE CATALOGO È INOLTRE PRESENTE UNA SEZIONE NELLA QUALE SONO RIPORTATI ARTICOLI DEFINITI "ACCESSORI". ESSI NON HANNO QUINDI LA FINALITÀ DI RISTABILIRE L'ASPETTO ORIGINARIO DEL VEICOLO MA SOLO LA FUNZIONE DI MIGLIORARE ESTETICAMENTE O MODIFICARE L'ASPETTO DEL PRODOTTO. PERTANTO TALI COMPONENTI NON DEVONO ESSERE CONSIDERATI RICAMBI BENSÌ ACCESSORI.

THIS CATALOGUE AIMS AT PROPERLY IDENTIFYING AND VERIFYING THE NECESSARY SPARE PARTS TO REPAIR THE CAR AND IDENTIFIES THE PRODUCTS/ITEMS DISTRIBUTED BY OLSA PARTS.

The products distributed by OLSA PARTS can be categorized into three different product types:

- 1) Original Equipment parts
- 2) Matching Quality spare parts
- 3) Universal parts

N.B. HEREBY DESCRIBED ARE THE DEFINITIONS OF ORIGINAL EQUIPMENT PARTS, MATCHING QUALITY SPARE PARTS AND UNIVERSAL PARTS IN ACCORDANCE WITH THE CURRENT LEGISLATION IN FORCE.

WITH THE EXCEPTION OF ORIGINAL EQUIPMENT PARTS, THE TYPE OF "MATCHING QUALITY SPARE PARTS" AND THE TYPE OF "UNIVERSAL PARTS" ARE EXPRESSLY STATED AT THE BOTTOM OF THE REPRESENTATION OF THE PRODUCT BELONGING TO THE ABOVE CATEGORIES.

IF NOT OTHERWISE INDICATED AT THE BOTTOM OF THE PRODUCT, AS IT IS FOR THE OTHER TWO TYPES, THE PARTS ARE TO BE CONSIDERED AS ORIGINAL EQUIPMENT.

In particular:

- 1) **ORIGINAL EQUIPMENT PARTS:** This catalogue shows original equipment parts as distributed by OLSA PARTS which are all manufactured by OLSA Spa as well as other products, manufactured by companies other than OLSA S.p.a. OLSA S.p.a. and the companies other than OLSA S.p.a. itself, whose products are shown in this catalogue and are distributed by OLSA PARTS, are manufacturers of original equipment parts in accordance with the law in force. Please note that according to the definition contained in paragraph 19, Title III of the Guidelines to the EU Regulation n. 461/2010, replacing Regulation n. 140/2002 (Monti Law), original equipment part means "PARTS OR EQUIPMENT WHICH ARE MANUFACTURED ACCORDING TO THE SPECIFICATIONS AND PRODUCTION STANDARD PROVIDED BY THE MOTOR VEHICLE MANUFACTURER [...] IT IS PRESUMED UNLESS THE CONTRARY IS PROVEN, THAT PARTS CONSTITUTE ORIGINAL PARTS IF THE PART MANUFACTURER CERTIFIES THAT THE PARTS MATCH THE QUALITY OF THE COMPONENTS USED FOR THE ASSEMBLY OF THE MOTOR VEHICLE IN QUESTION..."
- 2) **MATCHING QUALITY PARTS** are specified at the bottom of every single item belonging to category and for them, according to paragraph 20, Title III of the Guidelines to the EU Regulation n. 461/2010, replacing Regulation n. 140/2002 (Monti Law), it is to be assumed "PARTS WITH A SUFFICIENTLY HIGH QUALITY THAT THEIR USE DOES NOT ENDANGER THE REPUTATION OF THE AUTHORIZED NETWORK IN QUESTION..."
- 3) As UNIVERSAL PARTS, specifically indicated at the bottom of every single product (such as work lights, reflectors, dome lamps, side markers, revolving beacons etc) it is to be intended all items distributed by OLSA PARTS "not belonging to the category of original equipment part and/or to the category of matching quality part". Some of these products are subject to ministerial or European approval to certify their performance. For these specific items, OLSA PARTS distributes only certified and approved parts and, on customer's request, can provide the related documents.
- 4) **BRANDS MENTIONED IN THIS CATALOGUE ARE PROPERTY OF THE CAR MAKER WHICH THEY REFER TO. THEIR USE IN THIS CATALOGUE, AS WELL AS THE OE REFERENCES INCLUDED, ARE ONLY MEANT TO HELP AND FACILITATE THE IDENTIFICATION OF THE CAR MODEL WHICH THE SPARE PARTS MUST BE FITTED TO. FOR A CORRECT USE OF THE CROSS REFERENCES, PLEASE REFER TO THE SECTION "NOTES FOR CONSULTATION" AT THE END OF THIS CATALOGUE.**
- 5) **N.B. IN THIS CATALOGUE THERE IS A SECTION WHICH SHOWS ITEMS WHICH ARE DEFINED "ACCESSORIES". THEY ARE NOT INTENDED TO RESTORE THE ORIGINAL APPEARANCE OF THE VEHICLE, BUT THEY ONLY HAVE THE FUNCTION TO CHANGE OR TO IMPROVE THE APPEARANCE OF THE ITEM ITSELF. CONSEQUENTLY, THESE COMPONENTS SHOULD NOT BE CONSIDERED AS SPARE PARTS BUT JUST ACCESSORIES.**

CAR LAMPS
FANALI PER AUTOVETTURE

| ALFA ROMEO | | 33 | |
|---|---|---|----------------------|
|  | 83→94 | Gruppo ottico anteriore incolore <i>Front optical unit</i> | ➔ 2.01.106.12 |
| | | Gruppo ottico anteriore incolore <i>Front optical unit</i> | ➜ 2.01.107.12 |
| | * Ricambio di qualità equivalente <i>Matching quality spare parts</i> | | |

| ALFA ROMEO | | 145 | |
|---|---|---------------------------------------|----------------------|
|  | 94→98 | Fanale anteriore <i>Front lamp</i> | ➔ 2.01.108.00 |
| | | Fanale anteriore <i>Front lamp</i> | ➜ 2.01.109.00 |
| | * Ricambio di qualità equivalente <i>Matching quality spare parts</i> | | |

| AUDI | | A3 | |
|---|---|---------------------------------------|----------------------|
|  | 96→00 | Fanale anteriore <i>Front lamp</i> | ➔ 2.01.124.00 |
| | | Fanale anteriore <i>Front lamp</i> | ➜ 2.01.125.00 |
| | * Ricambio di qualità equivalente <i>Matching quality spare parts</i> | | |

| FIAT | | 500 F-L | |
|---|---|---|--------------------|
|  | 65→ | Fanale anteriore <i>Front lamp</i> | 1.01.050.00 |
| | | Trasparente anteriore incolore <i>Clear front lens</i> | 1.01.050.25 |
| | | Trasparente anteriore arancio <i>Orange front lens</i> | 1.01.050.24 |
| | * Ricambio di qualità equivalente <i>Matching quality spare parts</i> | | |

| FIAT | | CINQUECENTO | |
|---|---|--|----------------------|
|  | 92→98 | Fanale anteriore arancio <i>Orange front lamp</i> | ➔ 2.01.088.00 |
| | | Fanale anteriore arancio <i>Orange front lamp</i> | ➜ 2.01.089.00 |
| | * Ricambio di qualità equivalente <i>Matching quality spare parts</i> | | |

| FIAT | CINQUECENTO | | |
|---|--|---|---------------|
|  | 92→98 | Fanale anteriore incolore Clear front lamp | ➔ 2.01.090.00 |
| | | Fanale anteriore incolore Clear front lamp | ➔ 2.01.091.00 |
| | * Ricambio di qualità equivalente Matching quality spare parts | | |

| FIAT | 500 X | | |
|--|-------|--|---------------|
|   | 15→18 | Fanale anteriore DRL DRL front lamp | ➔ 1.01.054.00 |
| | | Fanale anteriore DRL DRL front lamp | ➔ 1.01.055.00 |
| | 17→ | Portalamпада con lampada blu Blue bulb holder | 1.01.054.18 |

| FIAT | 500 X | LED | |
|---|-------|--|---------------|
|  | 18→ | Fanale anteriore DRL DRL front lamp | ➔ 1.01.056.00 |
| | | Fanale anteriore DRL DRL front lamp | ➔ 1.01.057.00 |

| FIAT | PANDA | | |
|---|--|--|---------------|
|  | 86→03 | Trasparente anteriore arancio Orange front lens | ➔ 2.01.066.24 |
| | | Trasparente anteriore arancio Orange front lens | ➔ 2.01.067.24 |
| | * Ricambio di qualità equivalente Matching quality spare parts | | |

| FIAT | PANDA | | |
|---|--|--|---------------|
|  | 86→03 | Trasparente anteriore incolore Clear front lens | ➔ 2.01.068.25 |
| | | Trasparente anteriore incolore Clear front lens | ➔ 2.01.069.25 |
| | * Ricambio di qualità equivalente Matching quality spare parts | | |

| FIAT | | NUOVA PANDA | | |
|---|-----|--|---|--------------------|
|  | 12→ | Luce diurna anteriore <i>Front lamp DRL</i> | ➔ | 8.00.148.00 |
| | | Luce diurna anteriore <i>Front lamp DRL</i> | ➜ | 8.00.149.00 |
| | | | | |

| FIAT | | PANDA | | |
|---|-----|---|---|--------------------|
|  | 12→ | Gruppo ottico diurno anteriore <i>Front optical unit</i> | ➔ | 2.01.144.10 |
| | | Gruppo ottico diurno anteriore <i>Front optical unit</i> | ➜ | 2.01.145.10 |
| | | | * Ricambio di qualità equivalente Matching quality spare parts | |

| FIAT | | PUNTO | | |
|---|-------|--|---|--------------------|
|  | 93→99 | Fanale anteriore incolore <i>Clear front lamp</i> | ➔ | 2.01.050.00 |
| | | Fanale anteriore incolore <i>Clear front lamp</i> | ➜ | 2.01.051.00 |
| | | | * Ricambio di qualità equivalente Matching quality spare parts | |

| FIAT | | PUNTO | | |
|---|-------|--|---|--------------------|
|  | 93→99 | Fanale anteriore arancio <i>Orange front lamp</i> | ➔ | 2.01.052.00 |
| | | Fanale anteriore arancio <i>Orange front lamp</i> | ➜ | 2.01.053.00 |
| | | | * Ricambio di qualità equivalente Matching quality spare parts | |

| FIAT | | PUNTO EVO | | |
|---|-----|---------------------------------------|---|--------------------|
|  | 09→ | Fanale anteriore <i>Front lamp</i> | ➔ | 1.01.052.00 |
| | | Fanale anteriore <i>Front lamp</i> | ➜ | 1.01.053.00 |
| | | | | |

| FIAT | | SEICENTO | |
|---|---|--|----------------------|
|  | 98→00 | Fanale anteriore arancio <i>Orange front lamp</i> | ➔ 2.01.058.00 |
| | | Fanale anteriore arancio <i>Orange front lamp</i> | ➔ 2.01.059.00 |
| | * Ricambio di qualità equivalente Matching quality spare parts | | |

| FIAT | | SEICENTO | |
|---|---|--|----------------------|
|  | 98→00 | Fanale anteriore incolore <i>Clear front lamp</i> | ➔ 2.01.054.00 |
| | | Fanale anteriore incolore <i>Clear front lamp</i> | ➔ 2.01.055.00 |
| | * Ricambio di qualità equivalente Matching quality spare parts | | |

| FIAT | | SEICENTO | |
|---|---|--|----------------------|
|  | 00→ | Fanale anteriore incolore <i>Clear front lamp</i> | ➔ 2.01.060.00 |
| | | Fanale anteriore incolore <i>Clear front lamp</i> | ➔ 2.01.061.00 |
| | * Ricambio di qualità equivalente Matching quality spare parts | | |

| FIAT | | TIPO | |
|---|---|--|----------------------|
|  | →93 | Fanale anteriore incolore <i>Clear front lamp</i> | ➔ 2.01.094.00 |
| | | Fanale anteriore incolore <i>Clear front lamp</i> | ➔ 2.01.095.00 |
| | * Ricambio di qualità equivalente Matching quality spare parts | | |

| FIAT | | TIPO | |
|---|---|--|----------------------|
|  | →93 | Fanale anteriore arancio <i>Orange front lamp</i> | ➔ 2.01.096.00 |
| | | Fanale anteriore arancio <i>Orange front lamp</i> | ➔ 2.01.097.00 |
| | * Ricambio di qualità equivalente Matching quality spare parts | | |

| FIAT | | TIPO RESTYLING | |
|---|---|--|----------------------|
|  | 93→95 | Fanale anteriore incolore <i>Clear front lamp</i> | ➔ 2.01.098.00 |
| | | Fanale anteriore incolore <i>Clear front lamp</i> | ➜ 2.01.099.00 |
| | * Ricambio di qualità equivalente Matching quality spare parts | | |

| FIAT | | UNO | |
|---|---|--|----------------------|
|  | 89→ | Fanale anteriore arancio <i>Orange front lamp</i> | ➔ 2.01.084.00 |
| | | Fanale anteriore arancio <i>Orange front lamp</i> | ➜ 2.01.085.00 |
| | 89→ | Trasparente arancio <i>Orange lens</i> | ➔ 2.01.084.24 |
| | | Trasparente arancio <i>Orange lens</i> | ➜ 2.01.085.24 |
| | * Ricambio di qualità equivalente Matching quality spare parts | | |

| FIAT | | UNO | |
|---|---|--|----------------------|
|  | 89→ | Fanale anteriore incolore <i>Clear front lamp</i> | ➔ 2.01.086.00 |
| | | Fanale anteriore incolore <i>Clear front lamp</i> | ➜ 2.01.087.00 |
| | 89→ | Trasparente incolore <i>Clear lens</i> | ➔ 2.01.086.25 |
| | | Trasparente incolore <i>Clear lens</i> | ➜ 2.01.087.25 |
| | * Ricambio di qualità equivalente Matching quality spare parts | | |

| FIAT | | UNO RESTYLING | |
|---|---|---|----------------------|
|  | 89→94 | Gruppo ottico incolore <i>Clear front optical unit</i> | ➔ 2.01.062.12 |
| | | Gruppo ottico incolore <i>Clear front optical unit</i> | ➜ 2.01.063.12 |
| | * Ricambio di qualità equivalente Matching quality spare parts | | |





| FIAT | | UNO RESTYLING | |
|---|---|---|----------------------|
|  | 89→94 | Gruppo ottico arancio <i>Orange front optical unit</i> | ➔ 2.01.064.11 |
| | | Gruppo ottico arancio <i>Orange front optical unit</i> | ➜ 2.01.065.11 |
| | * Ricambio di qualità equivalente <i>Matching quality spare parts</i> | | |

| FORD | | FIESTA MK3 | |
|---|---|---------------------------------------|----------------------|
|  | 89→95 | Fanale anteriore <i>Front lamp</i> | ➔ 2.01.072.00 |
| | | Fanale anteriore <i>Front lamp</i> | ➜ 2.01.073.00 |
| | * Ricambio di qualità equivalente <i>Matching quality spare parts</i> | | |

| LANCIA | | DELTA | | LED | |
|---|---|---|---|--------------------|--|
|  | 08→ | Fanale anteriore luce diurna <i>Front lamp DRL</i> | ➔ | 5.01.054.00 | |
| | | Fanale anteriore luce diurna <i>Front lamp DRL</i> | ➜ | 5.01.055.00 | |
| | * Ricambio di qualità equivalente <i>Matching quality spare parts</i> | | | | |

| LANCIA | | Y 10 | |
|---|---|---------------------------------------|----------------------|
|  | 93→96 | Fanale anteriore <i>Front lamp</i> | ➔ 2.01.076.00 |
| | | Fanale anteriore <i>Front lamp</i> | ➜ 2.01.077.00 |
| | * Ricambio di qualità equivalente <i>Matching quality spare parts</i> | | |

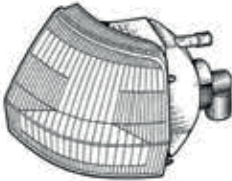
| LANCIA | | Y 10 | |
|---|---|---------------------------------------|----------------------|
|  | 96→00 | Fanale anteriore <i>Front lamp</i> | ➔ 2.01.078.00 |
| | | Fanale anteriore <i>Front lamp</i> | ➜ 2.01.079.00 |
| | * Ricambio di qualità equivalente <i>Matching quality spare parts</i> | | |

| LANCIA | | Y | |
|---|---|---------------------------------------|----------------------|
|  | 00→03 | Fanale anteriore <i>Front lamp</i> | ➔ 2.01.056.00 |
| | | Fanale anteriore <i>Front lamp</i> | ➜ 2.01.057.00 |
| | * Ricambio di qualità equivalente <i>Matching quality spare parts</i> | | |
| MERCEDES | | 200 - 500 (W124) | |
|  | 85→93 | Fanale anteriore <i>Front lamp</i> | ➔ 2.01.130.00 |
| | | Fanale anteriore <i>Front lamp</i> | ➜ 2.01.131.00 |
| | * Ricambio di qualità equivalente <i>Matching quality spare parts</i> | | |
| PEUGEOT | | 106 | |
|  | 91→96 | Fanale anteriore <i>Front lamp</i> | ➔ 2.01.112.00 |
| | | Fanale anteriore <i>Front lamp</i> | ➜ 2.01.113.00 |
| | * Ricambio di qualità equivalente <i>Matching quality spare parts</i> | | |
| RENAULT | | CLIO | |
|  | 90→96 | Fanale anteriore <i>Front lamp</i> | ➔ 2.01.114.00 |
| | | Fanale anteriore <i>Front lamp</i> | ➜ 2.01.115.00 |
| | Adatt. VALEO <i>Adaptable to VALEO</i> * Ricambio di qualità equivalente <i>Matching quality spare parts</i> | | |
| VOLKSWAGEN | | GOLF | |
|  | 74→89 | Fanale anteriore <i>Front lamp</i> | ➔ 2.01.122.00 |
| | | Trasparente <i>Lens</i> | ➔ 2.01.122.24 |
| | * Ricambio di qualità equivalente <i>Matching quality spare parts</i> | | |

VOLKSWAGEN

POLO 3° SERIE



99→02

Fanale anteriore
Front lamp







2.01.074.00

Fanale anteriore
Front lamp



2.01.075.00

*** Ricambio di qualità equivalente | Matching quality spare parts**

| ALFA ROMEO | | 147 | | |
|---|-------|--|---|--------------------|
|  | 00→04 | Fanale laterale <i>Side lamp</i> | ↔ | 1.02.052.00 |
| | | | | |
| ALFA ROMEO | | 147 RESTYLING | | |
|  | 00→10 | Gruppo ottico laterale <i>Side optical unit</i> | → | 1.02.054.12 |
| | | Gruppo ottico laterale <i>Side optical unit</i> | ← | 1.02.055.12 |
| | | | | |
| ALFA ROMEO | | 156 | | |
|  | 97→03 | Fanale laterale <i>Side lamp</i> | → | 1.02.056.00 |
| | | Fanale laterale <i>Side lamp</i> | ← | 1.02.057.00 |
| | | | | |
| ALFA ROMEO | | 156 | | |
|  | 04→ | Gruppo ottico laterale <i>Side optical unit</i> | → | 1.02.054.12 |
| | | Gruppo ottico laterale <i>Side optical unit</i> | ← | 1.02.055.12 |
| | | | | |
| ALFA ROMEO | | 159 | | |
|  | 06→ | Fanale laterale <i>Side lamp</i> | → | 1.02.124.00 |
| | | Fanale laterale <i>Side lamp</i> | ← | 1.02.125.00 |
| | | | | |





| ALFA ROMEO | | 166 | |
|---|-------|-------------------------------------|----------------------|
|  | 98→05 | Fanale laterale <i>Side lamp</i> | ➔ 1.02.126.00 |
| | | Fanale laterale <i>Side lamp</i> | ➔ 1.02.127.00 |
| | | | |

| ALFA ROMEO | | GT GTV MITO | |
|---|-----|--|---------------------------|
|  | 04→ | Gruppo ottico laterale <i>Side optical unit</i> | ➔ ➔ 1.02.060.00 |
| | | | |

| ALFA ROMEO | | GIULIETTA | |
|---|-----|-------------------------------------|----------------------|
|  | 10→ | Fanale laterale <i>Side lamp</i> | ➔ 1.02.160.00 |
| | | Fanale laterale <i>Side lamp</i> | ➔ 1.02.161.00 |
| | | | |

| ALFA ROMEO | | MITO | |
|---|-----|---|---------------------------|
|  | 08→ | Gruppo ottico laterale con molla in metallo <i>Side optical unit with metal spring</i> | ➔ ➔ 1.02.058.12 |
| | | | |

| AUDI | | Q2 | | LED | |
|---|-----|-----------------------------------|----------------------|-----|--|
|  | 16→ | Fanale laterale <i>Flasher</i> | ➔ 5.02.106.80 | | |
| | | Fanale laterale <i>Flasher</i> | ➔ 5.02.107.80 | | |
| | | | | | |

| BMW | | X5 | | |
|---|-------|---|--------|--------------------|
|  | 06→13 | Fanale laterale <i>Side lamp</i> | → | 1.02.182.00 |
| | | Fanale laterale <i>Side lamp</i> | ← | 1.02.183.00 |
| BMW | | E71 X6 | | |
|  | 07→14 | Fanale laterale incolore <i>Clear side lamp</i> | → | 1.02.188.00 |
| | | Fanale laterale incolore <i>Clear side lamp</i> | ← | 1.02.189.00 |
| BMW | | E89 Z4 | | |
|  | 09→16 | Fanale laterale <i>Side lamp</i> | → | 1.02.186.00 |
| | | Fanale laterale <i>Side lamp</i> | ← | 1.02.187.00 |
| CITRÖEN | | STANDARD | | |
|  | 06→ | Fanale laterale completo di lampada <i>Side lamp bulb included</i> | → ← | 1.02.148.00 |
| | | | | |
| CITRÖEN | | SAXO STANDARD TYPE | | |
|  | 96→03 | Gruppo ottico laterale incolore <i>Clear side optical unit</i> | → ← | 2.02.180.12 |
| | | * Ricambio di qualità equivalente Matching quality spare parts | | |





| FERRARI | | F151 | |
|---|--|---|----------------------|
|  | | Side marker posteriore rosso <i>Red rear side marker</i> | → 1.02.190.00 |
| | | Side marker posteriore rosso <i>Red rear side marker</i> | ← 1.02.191.00 |
| | | | |





| FERRARI | | F151 | |
|---|--|--|----------------------|
|  | | Side marker posteriore arancio <i>Orange rear side marker</i> | → 1.02.192.00 |
| | | Side marker posteriore arancio <i>Orange rear side marker</i> | ← 1.02.193.00 |
| | | | |





| FIAT | | BRAVO | |
|---|-----|---|---------------------------|
|  | 00→ | Gruppo ottico <i>Side optical unit</i> | → ← 1.02.070.00 |
| | | | |





| FIAT | | BRAVO | |
|---|-----|--|---------------------------|
|  | 06→ | Gruppo ottico con molla in metallo <i>Side optical unit with metal spring</i> | → ← 1.02.058.12 |
| | | | |





| FIAT | | BRAVO BRAVA | |
|---|-----|-------------------------------------|---------------------------|
|  | →01 | Fanale laterale <i>Side lamp</i> | → ← 1.02.068.00 |
| | | | |

| FIAT | | 500 | | |
|---|-----|--|---|--------------------|
|  | 65→ | Fanale laterale <i>Side lamp</i> | ↔ | 1.02.098.00 |
| FIAT | | CINQUECENTO TIPO | | |
|  | 92→ | Fanale laterale <i>Side lamp</i> | ↔ | 1.02.074.00 |
| FIAT | | NUOVA CINQUECENTO | | |
|  | 07→ | Gruppo ottico con molla in acciaio <i>Side optical unit with steel spring</i> | ↔ | 1.02.146.12 |
| FIAT | | COUPÈ BARCHETTA | | |
|  | 94→ | Fanale laterale <i>Side lamp</i> | ↔ | 1.02.076.00 |
| FIAT | | CROMA | | |
|  | 06→ | Gruppo ottico laterale <i>Side optical unit</i> | ↔ | 1.02.134.12 |

| FIAT | | GRANDE PUNTO | | |
|---|-------|--|---|--------------------|
|  | 05→ | Gruppo ottico laterale <i>Side optical unit</i> | ↔ | 1.02.080.12 |
| | | | | |
| FIAT | | IDEA STILO DOBLÒ | | |
|  | 03→ | Gruppo ottico laterale <i>Side optical unit</i> | ↔ | 1.02.080.12 |
| | | | | |
| FIAT | | MAREA BERLINA SW | | |
|  | 96→03 | Fanale laterale <i>Side lamp</i> | ↔ | 1.02.082.00 |
| | | | | |
| FIAT | | MULTIPLA | | |
|  | 04→ | Gruppo ottico laterale <i>Side optical unit</i> | ↔ | 1.02.080.12 |
| | | | | |
| FIAT | | PANDA 127 1° SERIE | | |
|  | 85→ | Fanale laterale <i>Side lamp</i> | ↔ | 1.02.088.00 |
| | | | | |

| FIAT | | PANDA | | |
|---|-------|--|---|--------------------|
|  | 86→03 | Fanale laterale <i>Side lamp</i> | ↔ | 1.02.090.00 |
| FIAT | | PANDA | | |
|  | 03→05 | Gruppo ottico laterale <i>Side optical unit</i> | ↔ | 1.02.080.12 |
| FIAT | | PUNTO | | |
|  | 93→99 | Fanale laterale <i>Side lamp</i> | ↔ | 1.02.092.00 |
| FIAT | | PUNTO DOBLÒ | | |
|  | 94→ | Gruppo ottico laterale <i>Side optical unit</i> | ↔ | 1.02.096.12 |
| FIAT | | QUBO FIORINO | | |
|  | 08→ | Fanale laterale <i>Side lamp</i> | ↔ | 1.02.080.12 |

| FIAT | | REGATA RITMO UNO | |
|---|-------|---|------------------------------|
|  | 89→ | Fanale laterale <i>Side lamp</i> | ↔ ↔ 2.02.052.00 |
| | | * Ricambio di qualità equivalente <i>Matching quality spare parts</i> | |
| FIAT | | SEICENTO MULTIPLA | |
|  | 98→04 | Fanale laterale arancio <i>Orange side lamp</i> | ↔ ↔ 1.02.078.00 |
| | | | |
| FIAT | | SEICENTO MULTIPLA | |
|  | 98→04 | Fanale laterale incolore <i>Clear side lamp</i> | ↔ ↔ 1.02.094.00 |
| | | | |
| FIAT | | UNO RESTYLING | |
|  | 04→ | Fanale laterale <i>Side lamp</i> | ↔ ↔ 1.02.066.00 |
| | | | |
| FIAT | | UNO RESTYLING | |
|  | 89→94 | Gruppo ottico laterale <i>Side optical unit</i> | ↔ ↔ 1.02.066.11 |
| | | | |

| FORD | | FIESTA | |
|---|--|--|------------------------------|
|  | 91→ | Fanale laterale <i>Side lamp</i> | ↗ ↖ 2.02.056.00 |
| | * Ricambio di qualità equivalente Matching quality spare parts | | |
| FORD | | FOCUS | |
|  | 06→ | Gruppo ottico laterale su specchio retrovisore <i>Side optical unit on rear view mirror</i> | ↗ 5.02.050.12 |
| | | Gruppo ottico laterale su specchio retrovisore <i>Side optical unit on rear view mirror</i> | ↖ 5.02.051.12 |
| | * Ricambio di qualità equivalente Matching quality spare parts | | |
| FORD | | FOCUS | |
|  | 98→04 | Gruppo ottico laterale arancio <i>Orange side optical unit</i> | ↗ ↖ 2.02.182.11 |
| | * Ricambio di qualità equivalente Matching quality spare parts | | |
| FORD | | FOCUS | |
|  | 98→04 | Gruppo ottico laterale incolore <i>Clear side optical unit</i> | ↗ ↖ 2.02.182.12 |
| | * Ricambio di qualità equivalente Matching quality spare parts | | |
| FORD | | GALAXY | |
|  | 06→ | Gruppo ottico laterale su specchio retrovisore <i>Side optical unit on rear view mirror</i> | ↗ 5.02.054.12 |
| | | Gruppo ottico laterale su specchio retrovisore <i>Side optical unit on rear view mirror</i> | ↖ 5.02.055.12 |
| | * Ricambio di qualità equivalente Matching quality spare parts | | |















| JEEP | | RENEGADE | | |
|---|-----|---|---|--------------------|
|  | 14→ | Fanale laterale anteriore <i>Front side lamp</i> | → | 1.02.168.00 |
| | | Fanale laterale anteriore <i>Front side lamp</i> | ← | 1.02.169.00 |
| | | | | |

| LANCIA | | MUSA | | |
|---|-----|--|--------|--------------------|
|  | 04→ | Gruppo ottico laterale <i>Side optical unit</i> | → ← | 1.02.080.12 |
| | | | | |

| LANCIA | | NUOVA DELTA | | |
|---|-----|--|---|--------------------|
|  | 08→ | Gruppo ottico laterale <i>Side optical unit</i> | → | 1.02.054.12 |
| | | Gruppo ottico laterale <i>Side optical unit</i> | ← | 1.02.055.12 |
| | | | | |

| LANCIA | | Y10 | | |
|---|-----|-------------------------------------|--------|--------------------|
|  | 89→ | Fanale laterale <i>Side lamp</i> | → ← | 1.02.066.00 |
| | | | | |

| LANCIA | | Y10 | | |
|---|-----|--|--------|--------------------|
|  | 89→ | Gruppo ottico laterale <i>Side optical unit</i> | → ← | 1.02.066.11 |
| | | | | |

| LANCIA | | Y10 | | |
|---|-------|--|--|--------------------|
|  | →89 | Fanale laterale <i>Side lamp</i> |   | 1.02.090.00 |
| | | | | |
| LANCIA | | Y | | |
|  | 96→ | Fanale laterale <i>Side lamp</i> |  | 1.02.136.00 |
| | | Fanale laterale <i>Side lamp</i> |  | 1.02.137.00 |
| | | | | |
| LANCIA | | Y | | |
|  | 00→03 | Gruppo ottico laterale <i>Side optical unit</i> |   | 1.02.110.12 |
| | | | | |
| LANCIA | | YPSILON LIBRA | | |
|  | 03→07 | Gruppo ottico laterale <i>Side optical unit</i> |   | 1.02.144.12 |
| | | | | |
| LANCIA | | YPSILON | | |
|  | 07→ | Gruppo ottico laterale con molla acciaio <i>Side optical unit with steel spring</i> |   | 1.02.146.12 |
| | | | | |





| MERCEDES | | CLASSE A-B | | |
|---|-------|---|---|--------------------|
|  | 04→08 | Fanale laterale su specchio retrovisore <i>Flasher on rear view mirror</i> | ➔ | 5.02.076.00 |
| | | Fanale laterale su specchio retrovisore <i>Flasher on rear view mirror</i> | ➜ | 5.02.077.00 |
| | | | | |

| MERCEDES | | CLASSE C | | LED |
|---|-------|---|---|--------------------|
|  | 04→07 | Fanale laterale su specchio retrovisore <i>Flasher on rear view mirror</i> | ➔ | 5.02.082.00 |
| | | Fanale laterale su specchio retrovisore <i>Flasher on rear view mirror</i> | ➜ | 5.02.083.00 |
| | | | | |

| MERCEDES | | CLASSE C | | LED |
|---|-------|-----------------------------------|---|--------------------|
|  | 07→14 | Fanale laterale <i>Flasher</i> | ➔ | 5.02.110.80 |
| | | Fanale laterale <i>Flasher</i> | ➜ | 5.02.111.80 |
| | | | | |

| MERCEDES | | CLASSE E (W210) | | |
|---|-----|---|--------|--------------------|
|  | 95→ | Gruppo ottico laterale incolore <i>Clear side optical unit</i> | ➔ ➜ | 2.02.184.12 |
| | | * Ricambio di qualità equivalente Matching quality spare parts | | |

| MERCEDES | | CLASSE C (W202) | | |
|---|-----|---|--------|--------------------|
|  | 97→ | Gruppo ottico laterale incolore <i>Clear side optical unit</i> | ➔ ➜ | 2.02.186.12 |
| | | * Ricambio di qualità equivalente Matching quality spare parts | | |

| MERCEDES | | CLASSE E | | |
|---|---|--|---------------------------|--|
|  | 02→06 | Fanale laterale con luce di cortesia <i>Flasher with cover for courtesy light</i> | ➔ 5.02.116.00 | |
| | | Fanale laterale con luce di cortesia <i>Flasher with cover for courtesy light</i> | ➜ 5.02.117.00 | |
| | | | | |
| MERCEDES | | CLASSE E | | |
|  | 06→09 | Fanale laterale <i>Flasher</i> | ➔ 5.02.118.00 | |
| | | Fanale laterale <i>Flasher</i> | ➜ 5.02.119.00 | |
| | | | | |
| MERCEDES | | CLASSE G | | |
|  | 84→ | Fanale laterale arancio <i>Orange side lamp</i> | ➔ ➜ 2.02.064.00 | |
| | | * Ricambio di qualità equivalente Matching quality spare parts | | |
| MERCEDES | | JEEP | | |
|  | 84→ | Fanale laterale incolore <i>Clear side lamp</i> | ➔ ➜ 2.02.066.00 | |
| | | Trasparente incolore <i>Clear lens</i> | ➔ ➜ 2.02.066.12 | |
| | * Ricambio di qualità equivalente Matching quality spare parts | | | |
| MERCEDES | | JEEP | | |
|  | 84→ | Fanale laterale arancio <i>Orange side lamp</i> | ➔ 2.02.068.00 | |
| | | Fanale laterale incolore <i>Clear side lamp</i> | ➜ 2.02.070.00 | |
| | Dimensioni / <i>Dimension</i> mm. 80x35 | | | |
| | * Ricambio di qualità equivalente Matching quality spare parts | | | |

| MINI | COOPER ONE | | | |
|---|--------------|-------------------------------------|---|--------------------|
|  | 13→18 | Fanale laterale <i>Side lamp</i> | ➔ | 1.02.180.00 |
| | | Fanale laterale <i>Side lamp</i> | ➜ | 1.02.181.00 |

| MINI | COOPER ONE | | | |
|---|--------------|--|---|--------------------|
|  | 06→13 | Fanale laterale anteriore arancio <i>Orange side lamp</i> | ➔ | 1.02.174.00 |
| | | Fanale laterale anteriore arancio <i>Orange side lamp</i> | ➜ | 1.02.175.00 |

| MINI | COOPER ONE | | | LED |
|---|--------------|--|---|--------------------|
|  | 13→18 | Fanale laterale anteriore arancio <i>Orange side lamp</i> | ➔ | 1.02.174.80 |
| | | Fanale laterale anteriore arancio <i>Orange side lamp</i> | ➜ | 1.02.175.80 |

| MINI | COOPER ONE | | | |
|---|--------------|--|---|--------------------|
|  | 06→13 | Fanale laterale posteriore rosso <i>Red side lamp</i> | ➔ | 1.02.176.00 |
| | | Fanale laterale posteriore rosso <i>Red side lamp</i> | ➜ | 1.02.177.00 |

| MINI | COOPER ONE | | | LED |
|---|--------------|--|---|--------------------|
|  | 00→04 | Fanale laterale posteriore rosso <i>Red side lamp</i> | ➔ | 1.02.176.80 |
| | | Fanale laterale posteriore rosso <i>Red side lamp</i> | ➜ | 1.02.177.80 |



| MINI | | R56 | | |
|---|-----|--|---|--------------------|
|  | 06→ | Fanale laterale arancio <i>Orange side lamp</i> | → | 1.02.164.00 |
| | | Fanale laterale arancio <i>Orange side lamp</i> | ← | 1.02.165.00 |
| | | | | |

| MINI | | R56 | | |
|---|-----|--|---|--------------------|
|  | 06→ | Fanale laterale incolore <i>Clear side lamp</i> | → | 1.02.166.00 |
| | | Fanale laterale incolore <i>Clear side lamp</i> | ← | 1.02.167.00 |
| | | | | |

| NISSAN | | JUKE | | LED |
|---|-----|-----------------------------------|---|--------------------|
|  | 10→ | Fanale laterale <i>Flasher</i> | → | 5.02.120.80 |
| | | Fanale laterale <i>Flasher</i> | ← | 5.02.121.80 |
| | | | | |

| OPEL | | AGILA | | |
|---|-----|-------------------------------------|--------|--------------------|
|  | 00→ | Fanale laterale <i>Side lamp</i> | → ← | 1.02.064.00 |
| | | | | |

| OPEL | | CORSA | | |
|---|-------|--|--------|--------------------|
|  | 00→05 | Gruppo ottico laterale <i>Side optical unit</i> | → ← | 1.02.102.12 |
| | | | | |

| OPEL | MERIVA | | | |
|---|-----------------|---|---|--------------------|
|  | 07→ | Gruppo ottico laterale <i>Side optical unit</i> | ↔ | 1.02.102.12 |
| * Ricambio di qualità equivalente Matching quality spare parts | | | | |
| PEUGEOT | 106 306 406 | | | |
|  | 96→03 | Gruppo ottico laterale <i>Side optical unit</i> | ↔ | 2.02.180.12 |
| * Ricambio di qualità equivalente Matching quality spare parts | | | | |
| PEUGEOT | 205 | | | |
|  | 89→94 | Fanale laterale <i>Side lamp</i> | ↔ | 2.02.054.00 |
| * Ricambio di qualità equivalente Matching quality spare parts | | | | |
| PEUGEOT | 208 | | | |
|  | 12→ | Gruppo ottico laterale su specchietto retrovisore <i>Side optical unit on rear view mirror</i> | ↔ | 5.02.100.12 |
| | | Gruppo ottico laterale su specchietto retrovisore <i>Side optical unit on rear view mirror</i> | ↔ | 5.02.101.12 |
| * Ricambio di qualità equivalente Matching quality spare parts | | | | |
| PEUGEOT | STANDARD | | | |
|  | 06→ | Fanale laterale completo di lampada <i>Side lamp bulb included</i> | ↔ | 1.02.148.00 |





| PORSCHE | | CAYENNE | | LED |
|---|-----|-----------------------------------|---|--------------------|
|  | 10→ | Fanale laterale <i>Flasher</i> | → | 5.02.122.80 |
| | | Fanale laterale <i>Flasher</i> | ← | 5.02.123.80 |

| PORSCHE | | PANAMERA | | LED |
|---|-----|-----------------------------------|---|--------------------|
|  | 16→ | Fanale laterale <i>Flasher</i> | → | 5.02.124.80 |
| | | Fanale laterale <i>Flasher</i> | ← | 5.02.125.80 |

| PORSCHE | | 991 | | |
|---|-------|-------------------------------------|---|--------------------|
|  | 00→04 | Fanale laterale <i>Side lamp</i> | → | 1.02.184.00 |
| | | Fanale laterale <i>Side lamp</i> | ← | 1.02.185.00 |

| RENAULT | | LAGUNA III | | |
|---|-----|-----------------------------------|---|--------------------|
|  | 07→ | Fanale laterale <i>Flasher</i> | → | 5.02.126.00 |
| | | Fanale laterale <i>Flasher</i> | ← | 5.02.127.00 |

| RENAULT | | CLIO | | |
|---|-------|---|--------|--------------------|
|  | 90→01 | Gruppo ottico laterale <i>Side optical unit</i> | → ← | 2.02.192.12 |
| | | * Ricambio di qualità equivalente Matching quality spare parts | | |

| RENAULT | | CLIO LAGUNA | | |
|---|-------|--|--------|--------------------|
|  | 01→ | Gruppo ottico laterale incolore <i>Clear side optical unit</i> | → ← | 1.02.116.12 |
| | | | | |
| RENAULT | | KANGOO | | |
|  | 07→13 | Gruppo ottico laterale incolore <i>Clear side optical unit</i> | → ← | 1.02.172.12 |
| | | | | |
| RENAULT OPEL | | MASTER MOVANO | | |
|  | 08→ | Gruppo ottico laterale su specchio retrovisore <i>Side optical unit on rear view mirror</i> | → | 5.42.066.12 |
| | | Gruppo ottico laterale su specchio retrovisore <i>Side optical unit on rear view mirror</i> | ← | 5.42.067.12 |
| | | | | |
| RENAULT OPEL | | MASTER MOVANO | | |
|  | 08→ | Gruppo ottico laterale su specchio retrovisore <i>Side optical unit on rear view mirror</i> | → | 5.42.068.12 |
| | | Gruppo ottico laterale su specchio retrovisore <i>Side optical unit on rear view mirror</i> | ← | 5.42.069.12 |
| | | | | |
| SEAT | | IBIZA ALTEA | | |
|  | 02→ | Gruppo ottico laterale <i>Side optical unit</i> | → ← | 1.02.132.12 |
| | | | | |

| SKODA | | FABIA | |
|---|-----|---|----------------------|
|  | 13→ | Gruppo ottico laterale su specchietto <i>Side optical unit on mirror</i> | ➔ 5.02.102.12 |
| | | Gruppo ottico laterale su specchietto <i>Side optical unit on mirror</i> | ➔ 5.02.103.12 |
| | | | |

| SKODA | | OCTAVIA | |
|---|-----|--|----------------------|
|  | 05→ | Fanale laterale su specchio retrovisore con luce pozzanghera <i>Side lamp on rear view mirror with courtesy light</i> | ➔ 1.02.154.00 |
| | | Fanale laterale su specchio retrovisore con luce pozzanghera <i>Side lamp on rear view mirror with courtesy light</i> | ➔ 1.02.155.00 |
| | | | |

| SKODA | | OCTAVIA II SUPERB II (→15) | |
|---|-------|-----------------------------------|----------------------|
|  | 08→13 | Fanale laterale <i>Flasher</i> | ➔ 5.02.128.00 |
| | | Fanale laterale <i>Flasher</i> | ➔ 5.02.129.00 |
| | | | |

| SKODA | | OCTAVIA III | | LED |
|---|-----|-----------------------------------|---|--------------------|
|  | 13→ | Fanale laterale <i>Flasher</i> | ➔ | 5.02.130.80 |
| | | Fanale laterale <i>Flasher</i> | ➔ | 5.02.131.80 |
| | | | | |

| SKODA | | SUPERB III KOMBI | | LED |
|---|-----|-----------------------------------|---|--------------------|
|  | 15→ | Fanale laterale <i>Flasher</i> | ➔ | 5.02.132.80 |
| | | Fanale laterale <i>Flasher</i> | ➔ | 5.02.133.80 |
| | | | | |





| SKODA | | YETI | |
|---|-------|-----------------------------------|----------------------|
|  | 09→12 | Fanale laterale <i>Flasher</i> | ➔ 5.02.134.00 |
| | | Fanale laterale <i>Flasher</i> | ➚ 5.02.135.00 |
| | | | |

| SKODA | | YETI | |
|---|-------|--|----------------------|
|  | 09→12 | Fanale laterale con luce di cortesia <i>Flasher with courtesy light</i> | ➔ 5.02.136.00 |
| | | Fanale laterale con luce di cortesia <i>Flasher with courtesy light</i> | ➚ 5.02.137.00 |
| | | | |

| SKODA | | YETI | |
|---|-------|-----------------------------------|----------------------|
|  | 09→17 | Fanale laterale <i>Flasher</i> | ➔ 5.02.138.00 |
| | | Fanale laterale <i>Flasher</i> | ➚ 5.02.139.00 |
| | | | |

| TOYOTA | | AURIS | |
|---|-------|-----------------------------------|----------------------|
|  | 10→12 | Fanale laterale <i>Flasher</i> | ➔ 5.02.140.00 |
| | | Fanale laterale <i>Flasher</i> | ➚ 5.02.141.00 |
| | | | |

| TOYOTA | | YARIS | |
|---|-----|-----------------------------------|----------------------|
|  | 14→ | Fanale laterale <i>Flasher</i> | ➔ 5.02.142.00 |
| | | Fanale laterale <i>Flasher</i> | ➚ 5.02.143.00 |
| | | | |

| TOYOTA | | YARIS | | |
|---|-------|---|--------|--------------------|
|  | 99→04 | Fanale laterale <i>Side lamp</i> | → | 1.02.158.00 |
| | | Fanale laterale <i>Side lamp</i> | ← | 1.02.159.00 |
| | | | | |
| VOLKSWAGEN | | CADDY LUPO FOX | | |
|  | 05→ | Gruppo ottico laterale <i>Side optical unit</i> | → ← | 1.02.100.12 |
| | | | | |
| VOLKSWAGEN | | GOLF | | |
|  | 83→92 | Fanale laterale <i>Side lamp</i> | → ← | 2.02.060.00 |
| | | * Ricambio di qualità equivalente Matching quality spare parts | | |
| VOLKSWAGEN | | GOLF | | |
|  | 83→93 | Fanale laterale <i>Side lamp</i> | → ← | 2.02.062.00 |
| | | * Ricambio di qualità equivalente Matching quality spare parts | | |
| VOLKSWAGEN | | GOLF PASSAT | | |
|  | 01→03 | Gruppo ottico laterale <i>Side optical unit</i> | → ← | 1.02.120.12 |
| | | | | |





| VOLKSWAGEN | | GOLF V GOLF PLUS PASSAT SHARAN | |
|---|-----|---|----------------------|
|  | 03→ | Fanale laterale su specchio retrovisore <i>Flasher on rear view mirror</i> | ➔ 1.02.122.00 |
| | | Fanale laterale su specchio retrovisore <i>Flasher on rear view mirror</i> | ➚ 1.02.123.00 |
| | | | |

| VOLKSWAGEN | | POLO | |
|---|-----|---|----------------------|
|  | →08 | Fanale laterale su specchio retrovisore <i>Side lamp on rear view mirror</i> | ➔ 1.02.150.00 |
| | | Fanale laterale su specchio retrovisore <i>Side lamp on rear view mirror</i> | ➚ 1.02.151.00 |
| | | | |

| VOLKSWAGEN | | TIGUAN SHARAN | |
|---|-----|---|----------------------|
|  | 05→ | Fanale laterale su specchio retrovisore <i>Side lamp on rear view mirror</i> | ➔ 1.02.156.00 |
| | | Fanale laterale su specchio retrovisore <i>Side lamp on rear view mirror</i> | ➚ 1.02.157.00 |
| | | | |

| VOLKSWAGEN | | TIGUAN | | LED |
|---|-----|-----------------------------------|---|--------------------|
|  | 16→ | Fanale laterale <i>Flasher</i> | ➔ | 5.02.146.80 |
| | | Fanale laterale <i>Flasher</i> | ➚ | 5.02.147.80 |
| | | | | |

| VOLKSWAGEN | | TIGUAN | | LED |
|---|-----|-----------------------------------|---|--------------------|
|  | 17→ | Fanale laterale <i>Flasher</i> | ➔ | 5.02.148.80 |
| | | Fanale laterale <i>Flasher</i> | ➚ | 5.02.149.80 |
| | | | | |

| VOLVO | | XC90 | | LED |
|---|-----|---|---|--------------------|
|  | 14→ | Fanale laterale <i>Flasher</i> | → | 5.02.144.80 |
| | | Fanale laterale <i>Flasher</i> | ← | 5.02.145.80 |
| UNIVERSALE | | | | |
|  | | Portalampada universale <i>Universal bulb holder</i> | | 1.09.050.00 |
| | | | | |
| UNIVERSALE | | | | |
|  | | Portalampada laterali <i>Side bulb holder</i> | | 1.09.051.00 |
| | | | | |
| UNIVERSALE | | | | |
|  | | Portalampada H4 <i>Bulb holder H4</i> | | 3.49.076.00 |
| | | | | |
| UNIVERSALE | | | | |
|  | | Portalampada H7 <i>Bulb holder H7</i> | | 3.49.078.00 |
| | | | | |

| ALFA ROMEO | | ALFA GT | |
|---|-----|---|----------------------|
|  | 08→ | Fanale posteriore retromarcia <i>Rear reverse lamp</i> | → 5.04.086.00 |
| | | Fanale posteriore retronebbia <i>Rear fog lamp</i> | ← 5.04.087.00 |

| ALFA ROMEO | | GIULIETTA | |
|---|-----|--|----------------------|
|  | 09→ | Fanale posteriore esterno <i>External rear lamp</i> | → 5.04.190.00 |
| | | Fanale posteriore esterno <i>External rear lamp</i> | ← 5.04.191.00 |

| ALFA ROMEO | | GIULIETTA | |
|---|-----|--|----------------------|
|  | 10→ | Fanale posteriore interno <i>Internal rear lamp</i> | → 5.04.192.00 |
| | | Fanale posteriore interno <i>Internal rear lamp</i> | ← 5.04.193.00 |

| ALFA ROMEO | | GIULIETTA | |
|---|-----|--|--------------------|
|  | 12→ | Fanale posteriore 3° stop <i>Additional stop lamp</i> | 1.04.144.00 |

| AUDI | | A7 | |
|---|-----|--|----------------------|
|  | 15→ | Fanale posteriore esterno <i>External rear lamp</i> | → 1.04.204.00 |
| | | Fanale posteriore esterno <i>External rear lamp</i> | ← 1.04.205.00 |

| AUDI | | A7 | |
|---|-----|--|----------------------|
|  | 15→ | Fanale posteriore interno <i>Internal rear lamp</i> | ➔ 1.04.202.00 |
| | | Fanale posteriore interno <i>Internal rear lamp</i> | ➠ 1.04.203.00 |

| AUDI | | Q3 | |
|---|-----|---------------------------------------|----------------------|
|  | 11→ | Fanale posteriore <i>Rear lamp</i> | ➔ 1.04.146.00 |
| | | Fanale posteriore <i>Rear lamp</i> | ➠ 1.04.147.00 |

| AUDI | | TT | |
|--|-----|---|----------------------|
|  | 14→ | Fanale posteriore <i>Rear lamp</i> | ➔ 1.04.206.00 |
| | | Fanale posteriore <i>Rear lamp</i> | ➠ 1.04.207.00 |
| | | Paratia posteriore <i>Rear bezel</i> | ➔ 1.04.206.17 |
| | | Paratia posteriore <i>Rear bezel</i> | ➠ 1.04.207.17 |

| BMW | | SERIE 1 (F20) | |
|---|-----|---|----------------------|
|  | 15→ | Fanale posteriore esterno con posizione a led <i>External rear lamp with led parking light</i> | ➔ 1.04.254.00 |
| | | Fanale posteriore esterno con posizione a led <i>External rear lamp with led parking light</i> | ➠ 1.04.255.00 |

| BMW | | SERIE 1 (F20) | |
|---|-----|---|----------------------|
|  | 15→ | Fanale posteriore interno con posizione a led <i>Internal rear lamp with led parking light</i> | ➔ 1.04.256.00 |
| | | Fanale posteriore interno con posizione a led <i>Internal rear lamp with led parking light</i> | ➠ 1.04.257.00 |

| BMW | | SERIE 2 ACTIVE TOURER (F45) | | |
|---|-----|---|---|--------------------|
|  | 14→ | Fanale posteriore esterno con posizione a led <i>External rear lamp with led parking light</i> | → | 1.04.246.00 |
| | | Fanale posteriore esterno con posizione a led <i>External rear lamp with led parking light</i> | ← | 1.04.247.00 |
| | | | | |

| BMW | | SERIE 2 ACTIVE TOURER (F45) | | |
|---|-----|--|---|--------------------|
|  | 14→ | Fanale posteriore esterno <i>External rear lamp</i> | → | 1.04.248.00 |
| | | Fanale posteriore esterno <i>External rear lamp</i> | ← | 1.04.249.00 |
| | | | | |

| BMW | | SERIE 2 ACTIVE TOURER (F45) | | |
|---|-----|---|---|--------------------|
|  | 14→ | Fanale posteriore interno con posizione a led <i>Internal rear lamp with led parking light</i> | → | 1.04.250.00 |
| | | Fanale posteriore interno con posizione a led <i>Internal rear lamp with led parking light</i> | ← | 1.04.251.00 |
| | | | | |

| BMW | | SERIE 2 ACTIVE TOURER (F45) | | |
|---|-----|--|---|--------------------|
|  | 14→ | Fanale posteriore interno <i>Internal rear lamp</i> | → | 1.04.252.00 |
| | | Fanale posteriore interno <i>Internal rear lamp</i> | ← | 1.04.253.00 |
| | | | | |

| BMW | | SERIE 2 GRAN TOURER (F46) | | |
|---|-------|--|---|--------------------|
|  | 15→20 | Fanale posteriore esterno <i>External rear lamp</i> | → | 1.04.322.00 |
| | | Fanale posteriore esterno <i>External rear lamp</i> | ← | 1.04.323.00 |
| | | | | |

| BMW | | SERIE 2 GRAN TOURER (F46) | | |
|---|-------|--|---|--------------------|
|  | 15→20 | Fanale posteriore esterno con guida luce a led <i>External rear lamp with led parking light</i> | ➔ | 1.04.334.00 |
| | | Fanale posteriore esterno con guida luce a led <i>External rear lamp with led parking light</i> | ➜ | 1.04.335.00 |
| | | | | |

| BMW | | SERIE 2 GRAN TOURER (F46) | | |
|---|-------|--|---|--------------------|
|  | 15→20 | Fanale posteriore interno con guida luce a led <i>Internal rear lamp with led parking light</i> | ➔ | 1.04.336.00 |
| | | Fanale posteriore interno con guida luce a led <i>Internal rear lamp with led parking light</i> | ➜ | 1.04.337.00 |
| | | | | |

| BMW | | SERIE 2 GRAN TOURER (F46) | | |
|---|-------|--|---|--------------------|
|  | 15→20 | Fanale posteriore interno <i>Internal rear lamp</i> | ➔ | 1.04.324.00 |
| | | Fanale posteriore interno <i>Internal rear lamp</i> | ➜ | 1.04.325.00 |
| | | | | |

| BMW | | X1 (E84) | | |
|---|-------|--|--|--------------------|
|  | 09→15 | Fanale posteriore esterno <i>External rear lamp</i> | ➔ | 1.04.134.00 |
| | | Fanale posteriore esterno <i>External rear lamp</i> | ➜ | 1.04.135.00 |
| | | | Versione con guide ottiche LED <i>Version with LED lamp guides</i> | |

| BMW | | X1 (E84) | | |
|---|-------|--|---|--------------------|
|  | 09→15 | Fanale posteriore esterno <i>External rear lamp</i> | ➔ | 1.04.136.00 |
| | | Fanale posteriore esterno <i>External rear lamp</i> | ➜ | 1.04.137.00 |
| | | | | |

| BMW | | X1 (E84) | |
|---|--|--|----------------------|
|  | 09→15 | Fanale posteriore interno <i>Internal rear lamp</i> | ➔ 1.04.138.00 |
| | | Fanale posteriore interno <i>Internal rear lamp</i> | ➜ 1.04.139.00 |
| | Versione con guide ottiche LED <i>Version with LED lamp guides</i> | | |

| BMW | | X1 (E84) | |
|---|-------|--|----------------------|
|  | 09→15 | Fanale posteriore interno <i>Internal rear lamp</i> | ➔ 1.04.140.00 |
| | | Fanale posteriore interno <i>Internal rear lamp</i> | ➜ 1.04.141.00 |
| | | | |

| BMW | | X1 (F48) | |
|---|-----|--|----------------------|
|  | 15→ | Fanale posteriore esterno <i>External rear lamp</i> | ➔ 1.04.242.00 |
| | | Fanale posteriore esterno <i>External rear lamp</i> | ➜ 1.04.243.00 |
| | | | |

| BMW | | X1 (F48) | |
|---|-----|---|----------------------|
|  | 15→ | Fanale posteriore esterno con posizione a led <i>External rear lamp with led parking light</i> | ➔ 1.04.244.00 |
| | | Fanale posteriore esterno con posizione a led <i>External rear lamp with led parking light</i> | ➜ 1.04.245.00 |
| | | | |

| BMW | | X1 (F48) | |
|---|-----|--|----------------------|
|  | 15→ | Fanale posteriore interno <i>Internal rear lamp</i> | ➔ 1.04.238.00 |
| | | Fanale posteriore interno <i>Internal rear lamp</i> | ➜ 1.04.239.00 |
| | | | |

| BMW | | X1 (F48) | |
|---|-----|---|----------------------|
|  | 15→ | Fanale posteriore interno con posizione a led <i>Internal rear lamp with led parking light</i> | ➔ 1.04.240.00 |
| | | Fanale posteriore interno con posizione a led <i>Internal rear lamp with led parking light</i> | ➔ 1.04.241.00 |
| | | | |

| BMW | | X1 RESTYLING (F48 LCI) | | LED |
|---|-----|--|---|--------------------|
|  | 19→ | Fanale posteriore esterno <i>External rear lamp</i> | ➔ | 1.04.330.80 |
| | | Fanale posteriore esterno <i>External rear lamp</i> | ➔ | 1.04.331.80 |
| | | | | |

| BMW | | X1 RESTYLING (F48 LCI) | | LED |
|---|-----|--|---|--------------------|
|  | 19→ | Fanale posteriore interno <i>Internal rear lamp</i> | ➔ | 1.04.332.80 |
| | | Fanale posteriore interno <i>Internal rear lamp</i> | ➔ | 1.04.333.80 |
| | | | | |

| BMW | | X1 RESTYLING (F48 LCI) USA | | LED |
|---|-----|--|---|--------------------|
|  | 19→ | Fanale posteriore esterno <i>External rear lamp</i> | ➔ | 1.04.330.16 |
| | | Fanale posteriore esterno <i>External rear lamp</i> | ➔ | 1.04.331.16 |
| | | | | |

| BMW | | X1 RESTYLING (F48 LCI) USA | | LED |
|---|-----|--|---|--------------------|
|  | 19→ | Fanale posteriore interno <i>Internal rear lamp</i> | ➔ | 1.04.332.16 |
| | | Fanale posteriore interno <i>Internal rear lamp</i> | ➔ | 1.04.333.16 |
| | | | | |



| BMW | | X2 (F39) | | LED |
|---|-----|--|---|--------------------|
|  | 18→ | Fanale posteriore esterno <i>External rear lamp</i> | → | 1.04.306.80 |
| | | Fanale posteriore esterno <i>External rear lamp</i> | ← | 1.04.307.80 |
| | | | | |

| BMW | | X2 (F39) | | LED |
|---|-----|--|---|--------------------|
|  | 18→ | Fanale posteriore interno <i>Internal rear lamp</i> | → | 1.04.304.80 |
| | | Fanale posteriore interno <i>Internal rear lamp</i> | ← | 1.04.305.80 |
| | | | | |

| BMW | | X2 (F39) USA | | LED |
|---|-----|--|---|--------------------|
|  | 18→ | Fanale posteriore esterno <i>External rear lamp</i> | → | 1.04.300.80 |
| | | Fanale posteriore esterno <i>External rear lamp</i> | ← | 1.04.301.80 |
| | | | | |

| BMW | | X2 (F39) USA | | LED |
|---|-----|--|---|--------------------|
|  | 18→ | Fanale posteriore interno <i>Internal rear lamp</i> | → | 1.04.302.80 |
| | | Fanale posteriore interno <i>Internal rear lamp</i> | ← | 1.04.303.80 |
| | | | | |

| CITROËN | | BERLINGO | | |
|---|-----|---------------------------------------|-------------------|--------------------|
|  | 08→ | Fanale posteriore <i>Rear lamp</i> | → | 5.04.180.00 |
| | | Fanale posteriore <i>Rear lamp</i> | ← | 5.04.181.00 |
| | | | 2 porte 2 doors | |

| CITROËN | | C4 | |
|---|-------------------|---|---|
|  | 04→08 | Gruppo ottico retronebbia <i>Rear fog optical unit</i> | ➔ 2024101003 |
| | | Gruppo ottico retronebbia <i>Rear fog optical unit</i> | ➜ 2024001003 |
| | 3 porte 3 doors | |  |

| CITROËN | | NEMO | |
|--|-------------------|--|---|
|  | 07→ | Fanale posteriore <i>Rear lamp</i> | ➔ 5.04.172.00 |
| | | Fanale posteriore <i>Rear lamp</i> | ➜ 5.04.173.00 |
| | | Gruppo ottico posteriore <i>Rear optical unit</i> | ➔ 2.04.062.10 |
| | | Gruppo ottico posteriore <i>Rear optical unit</i> | ➜ 2.04.063.10 |
| | 2 porte 2 doors | | * Ricambio di qualità equivalente Matching quality spare parts |

| DACIA | | DOKKER | |
|---|---|--|----------------------|
|  | 12→ | Gruppo ottico posteriore <i>Rear optical unit</i> | ➔ 2.04.118.10 |
| | | Gruppo ottico posteriore <i>Rear optical unit</i> | ➜ 2.04.119.10 |
| | * Ricambio di qualità equivalente Matching quality spare parts | | |

| DACIA | | DUSTER | |
|---|---|--|----------------------|
|  | 09→ | Gruppo ottico posteriore <i>Rear optical unit</i> | ➔ 2.04.086.10 |
| | | Gruppo ottico posteriore <i>Rear optical unit</i> | ➜ 2.04.087.10 |
| | * Ricambio di qualità equivalente Matching quality spare parts | | |





| FERRARI | | 458 | |
|---|-------|---|----------------------|
|  | 09→15 | Fanale posteriore retronebbia <i>Rear fog lamp</i> | ➔ 1.04.314.00 |
| | | Fanale posteriore retronebbia <i>Rear fog lamp</i> | ➔ 1.04.315.00 |

| FERRARI | | 488 | |
|---|--|--|--------------------|
|  | | Fanale posteriore retronebbia centrale <i>Central rear fog lamp</i> | 1.04.316.00 |
| | | | |

| FERRARI | | F142 | | LED | |
|---|--|--|--|--------------------|--|
|  | | Fanale posteriore 3° stop <i>Additional stop lamp</i> | | 1.04.318.80 | |
| | | | | | |

| FERRARI | | GTC4LUSSO | |
|---|-----|--|--------------------|
|  | 12→ | Fanale posteriore 3° stop <i>Additional stop lamp</i> | 1.04.320.80 |
| | | | |

| FIAT | | 126 | |
|---|-------|--|----------------------|
|  | 73→87 | Fanale posteriore <i>Rear lamp</i> | ➔ 2.04.078.00 |
| | | Fanale posteriore <i>Rear lamp</i> | ➔ 2.04.079.00 |
| | | Trasparente posteriore <i>Rear lens</i> | ➔ 2.04.078.20 |
| | | Trasparente posteriore <i>Rear lens</i> | ➔ 2.04.079.20 |
| * Ricambio di qualità equivalente Matching quality spare parts | | | |

| FIAT | | 126 BIS | |
|---|-------|---|----------------------|
|  | 73→87 | Fanale posteriore <i>Rear lamp</i> | ➔ 2.04.080.00 |
| | | Fanale posteriore <i>Rear lamp</i> | ➜ 2.04.081.00 |
| | | Trasparente posteriore <i>Rear lens</i> | ➔ 2.04.080.20 |
| | | Trasparente posteriore <i>Rear lens</i> | ➜ 2.04.081.20 |
| | | * Ricambio di qualità equivalente <i>Matching quality spare parts</i> | |
| FIAT | | CINQUECENTO | |
|  | 92→98 | Gruppo ottico posteriore <i>Rear optical unit</i> | ➔ 2.04.082.10 |
| | | Gruppo ottico posteriore <i>Rear optical unit</i> | ➜ 2.04.083.10 |
| | | * Ricambio di qualità equivalente <i>Matching quality spare parts</i> | |
| FIAT | | 500 | |
|  | 65→85 | Fanale posteriore <i>Rear lamp</i> | ➔ 2.04.056.00 |
| | | Fanale posteriore <i>Rear lamp</i> | ➜ 2.04.057.00 |
| | | Trasparente posteriore <i>Rear lens</i> | ➔ 2.04.056.20 |
| | | Trasparente posteriore <i>Rear lens</i> | ➜ 2.04.057.20 |
| | | * Ricambio di qualità equivalente <i>Matching quality spare parts</i> | |
| FIAT | | DOBLÒ | |
|  | 00→ | Fanale posteriore 3° stop <i>Additional stop lamp</i> | 1.04.082.00 |
| | | | |

| FIAT | DOBLÒ | | | |
|---|-------|--|---|--------------------|
|  | 00→04 | Fanale posteriore <i>Rear lamp</i> | ➔ | 5.04.052.00 |
| | | Fanale posteriore <i>Rear lamp</i> | ➜ | 5.04.053.00 |
| | | Gruppo ottico posteriore <i>Rear optical unit</i> | ➔ | 2.04.052.10 |
| | | Gruppo ottico posteriore <i>Rear optical unit</i> | ➜ | 2.04.053.10 |
| * Ricambio di qualità equivalente Matching quality spare parts | | | | |

| FIAT | DOBLÒ | | | |
|---|-------|--|---|--------------------|
|  | 05→09 | Fanale posteriore <i>Rear lamp</i> | ➔ | 5.04.070.00 |
| | | Fanale posteriore <i>Rear lamp</i> | ➜ | 5.04.071.00 |
| | | Gruppo ottico posteriore <i>Rear optical unit</i> | ➔ | 2.04.050.10 |
| | | Gruppo ottico posteriore <i>Rear optical unit</i> | ➜ | 2.04.051.10 |
| * Ricambio di qualità equivalente Matching quality spare parts | | | | |

| FIAT | DOBLÒ | | | |
|---|------------------|--|---|--------------------|
|  | 14→ | Gruppo ottico posteriore <i>Rear optical unit</i> | ➔ | 2.04.116.10 |
| | | Gruppo ottico posteriore <i>Rear optical unit</i> | ➜ | 2.04.117.10 |
| | 1 porta 1 door | | * Ricambio di qualità equivalente Matching quality spare parts | |

| FIAT | | DOBLÒ MY 09 | | |
|---|-------------------|--|---|--------------------|
|  | 09→14 | Fanale posteriore <i>Rear lamp</i> | ➔ | 5.04.196.00 |
| | | Fanale posteriore <i>Rear lamp</i> | ➜ | 5.04.197.00 |
| | | Gruppo ottico posteriore <i>Rear optical unit</i> | ➔ | 2.04.076.10 |
| | | Gruppo ottico posteriore <i>Rear optical unit</i> | ➜ | 2.04.077.10 |
| | 2 porte 2 doors | | * Ricambio di qualità equivalente Matching quality spare parts | |

| FIAT | | DOBLÒ MY 09 | | |
|--|-----|--|--|--------------------|
|  | 09→ | Fanale posteriore 3° stop <i>Additional stop lamp</i> | | 1.04.216.00 |
| | | | | |



| FIAT | | DOBLÒ MY 09 | | |
|---|------------------|--|---|--------------------|
|  | 09→14 | Gruppo ottico posteriore <i>Rear optical unit</i> | ➔ | 2.04.074.10 |
| | | Gruppo ottico posteriore <i>Rear optical unit</i> | ➜ | 2.04.075.10 |
| | 1 porta 1 door | | * Ricambio di qualità equivalente Matching quality spare parts | |

| FIAT | | DOBLÒ FL | | |
|---|-------------------|--|---|--------------------|
|  | 14→ | Gruppo ottico posteriore <i>Rear optical unit</i> | ➔ | 2.04.104.10 |
| | | Gruppo ottico posteriore <i>Rear optical unit</i> | ➜ | 2.04.105.10 |
| | 2 porte 2 doors | | * Ricambio di qualità equivalente Matching quality spare parts | |

| FIAT | | FIORINO - QUBO | |
|---|-------------------|--|---|
|  | 08→ | Fanale posteriore <i>Rear lamp</i> | → 5.04.172.00 |
| | | Fanale posteriore <i>Rear lamp</i> | ← 5.04.173.00 |
| | | Gruppo ottico posteriore <i>Rear optical unit</i> | → 2.04.062.10 |
| | | Gruppo ottico posteriore <i>Rear optical unit</i> | ← 2.04.063.10 |
| | 2 porte 2 doors | | * Ricambio di qualità equivalente Matching quality spare parts |

| FIAT | | FIORINO - QUBO | |
|--|-----|--|--------------------|
|  | 07→ | Fanale posteriore 3° stop <i>Additional stop lamp</i> | 1.04.214.00 |
| | | | |

| FIAT-CITROËN PEUGEOT | | QUBO-FIORINO-NEMO-BIPPER | |
|---|------------------|--|---|
|  | 08→ | Gruppo ottico posteriore <i>Rear optical unit</i> | → 2.04.060.10 |
| | | Gruppo ottico posteriore <i>Rear optical unit</i> | ← 2.04.061.10 |
| | 1 porta 1 door | | * Ricambio di qualità equivalente Matching quality spare parts |

| FIAT | | IDEA | |
|--|-----|--|----------------------|
|   | 06→ | Gruppo ottico posteriore <i>Rear optical unit</i> | → 1.04.060.10 |
| | | Gruppo ottico posteriore <i>Rear optical unit</i> | ← 1.04.061.10 |
| | | Portalampane <i>Bulb holder</i> | → 1.04.060.18 |
| | | Portalampane <i>Bulb holder</i> | ← 1.04.061.18 |

| FIAT | | NUOVA 500 | | |
|---|-------|---------------------------------------|---|--------------------|
|  | 07→15 | Fanale posteriore <i>Rear lamp</i> | ➔ | 5.04.102.00 |
| | | Fanale posteriore <i>Rear lamp</i> | ➜ | 5.04.103.00 |
| | | | | |

| FIAT | | NUOVA 500 FL | | |
|---|-----|---------------------------------------|---|--------------------|
|  | 15→ | Fanale posteriore <i>Rear lamp</i> | ➔ | 5.04.258.00 |
| | | Fanale posteriore <i>Rear lamp</i> | ➜ | 5.04.259.00 |
| | | | | |

| FIAT | | NUOVA 500 | | |
|---|-----|---|---|--------------------|
|  | 15→ | Fanale posteriore retromarcia <i>Rear reverse lamp</i> | ➔ | 1.04.198.00 |
| | | Fanale posteriore retronebbia <i>Rear fog lamp</i> | ➜ | 1.04.199.00 |
| | | | | |

| FIAT | | NUOVA 500 UK | | |
|---|-----|---|-------------------------|--------------------|
|  | 15→ | Fanale posteriore retronebbia <i>Rear fog lamp</i> | ➔ | 1.04.200.06 |
| | | Fanale posteriore retromarcia <i>Rear reverse lamp</i> | ➜ | 1.04.201.06 |
| | | | <i>Right hand drive</i> | |

| FIAT | | NUOVA 500L LIVING TREKKING | | |
|---|-------|---|---|--------------------|
|  | 12→15 | Fanale posteriore retromarcia <i>Rear reverse lamp</i> | ➔ | 5.04.112.00 |
| | | Fanale posteriore retronebbia <i>Rear fog lamp</i> | ➜ | 5.04.113.00 |
| | | | | |





| FIAT | | 500L (330) | | |
|------|-----|---------------------------------------|---|--------------------|
| | 12→ | Fanale posteriore <i>Rear lamp</i> | ➔ | 1.04.142.00 |
| | | Fanale posteriore <i>Rear lamp</i> | ➜ | 1.04.143.00 |
| | | | | |

| FIAT | | 500L (330) USA | | |
|------|-----|---------------------------------------|---|--------------------|
| | 12→ | Fanale posteriore <i>Rear lamp</i> | ➔ | 1.04.142.16 |
| | | Fanale posteriore <i>Rear lamp</i> | ➜ | 1.04.143.16 |
| | | | | |

| FIAT | | 500L CROSS | | |
|------|-----|--|---|--------------------|
| | 17→ | Fanale posteriore <i>trek paint</i> <i>Trek paint rear lamp</i> | ➔ | 1.04.152.90 |
| | | Fanale posteriore <i>trek paint</i> <i>Trek paint rear lamp</i> | ➜ | 1.04.153.90 |
| | | | | |

| FIAT | | 500L CROSS USA | | |
|------|-----|--|---|--------------------|
| | 17→ | Fanale posteriore <i>trek paint</i> <i>Trek paint rear lamp</i> | ➔ | 1.04.298.16 |
| | | Fanale posteriore <i>trek paint</i> <i>Trek paint rear lamp</i> | ➜ | 1.04.299.16 |
| | | | | |



| FIAT | | NUOVA 500L LIVING (330) | | |
|------|-----|---------------------------------------|---|--------------------|
| | 13→ | Fanale posteriore <i>Rear lamp</i> | ➔ | 1.04.152.00 |
| | | Fanale posteriore <i>Rear lamp</i> | ➜ | 1.04.153.00 |
| | | | | |

| FIAT | | NUOVA 500L TREKKING (330) | | |
|---|-------|---|-------------------------|--------------------|
|  | 13→ | Fanale posteriore satinato <i>Satin rear lamp</i> | → | 1.04.150.00 |
| | | Fanale posteriore satinato <i>Satin rear lamp</i> | ← | 1.04.151.00 |
| | | | | |
| FIAT | | 500 L WAGON - CROSS | | |
|  | 15→ | Fanale posteriore retromarcia <i>Rear reverse lamp</i> | → | 1.04.198.00 |
| | | Fanale posteriore retronebbia <i>Rear fog lamp</i> | ← | 1.04.199.00 |
| | | | | |
| FIAT | | 500 X (334) | | |
|  | 15→18 | Fanale posteriore cromato <i>Chrome rear lamp</i> | → | 1.04.186.00 |
| | | Fanale posteriore cromato <i>Chrome rear lamp</i> | ← | 1.04.187.00 |
| | | | | |
| FIAT | | 500 X (334) UK | | |
|  | 15→18 | Fanale posteriore cromato <i>Chrome rear lamp</i> | → | 1.04.190.06 |
| | | Fanale posteriore cromato <i>Chrome rear lamp</i> | ← | 1.04.191.06 |
| | | | <i>Right hand drive</i> | |
| FIAT | | 500 X TREKKING | | |
|  | 15→17 | Fanale posteriore satinato <i>Satin rear lamp</i> | → | 1.04.188.00 |
| | | Fanale posteriore satinato <i>Satin rear lamp</i> | ← | 1.04.189.00 |
| | | | | |

| FIAT | | 500 X (334 RESTYLING) | |
|---|-----|---------------------------------------|----------------------|
|  | 18→ | Fanale posteriore <i>Rear lamp</i> | ➔ 1.04.296.00 |
| | | Fanale posteriore <i>Rear lamp</i> | ➔ 1.04.297.00 |
| | | | |

| FIAT | | 500 X (334 RESTYLING) UK | |
|---|-----|---------------------------------------|----------------------|
|  | 18→ | Fanale posteriore <i>Rear lamp</i> | ➔ 1.04.296.06 |
| | | Fanale posteriore <i>Rear lamp</i> | ➔ 1.04.297.06 |
| | | <i>Right hand drive</i> | |

| FIAT | | 500 X (334 RESTYLING) USA | |
|---|-----|---------------------------------------|----------------------|
|  | 18→ | Fanale posteriore <i>Rear lamp</i> | ➔ 1.04.296.16 |
| | | Fanale posteriore <i>Rear lamp</i> | ➔ 1.04.297.16 |
| | | | |

| FIAT | | PANDA 750 | |
|--|-------|--|----------------------|
|   | 86→03 | Fanale posteriore <i>Rear lamp</i> | ➔ 1.04.062.00 |
| | | Fanale posteriore <i>Rear lamp</i> | ➔ 1.04.063.00 |
| | | Gruppo ottico posteriore <i>Rear optical unit</i> | ➔ 1.04.062.10 |
| | | Gruppo ottico posteriore <i>Rear optical unit</i> | ➔ 1.04.063.10 |
| | | | |

| FIAT | | PANDA | | | |
|---|-------|---|---|--------------------|--|
|  | 03→12 | Gruppo ottico posteriore <i>Rear optical unit</i> | → | 2.04.072.10 | |
| | | Gruppo ottico posteriore <i>Rear optical unit</i> | ← | 2.04.073.10 | |
| | | Corpo rosso <i>Red body</i> | | | |
| | | * Ricambio di qualità equivalente Matching quality spare parts | | | |

| FIAT | | PANDA | | | |
|---|-------|---|---|--------------------|--|
|  | 03→12 | Gruppo ottico posteriore <i>Rear optical unit</i> | → | 2.04.070.10 | |
| | | Gruppo ottico posteriore <i>Rear optical unit</i> | ← | 2.04.071.10 | |
| | | Corpo nero <i>Black body</i> | | | |
| | | * Ricambio di qualità equivalente Matching quality spare parts | | | |

| FIAT | | NUOVA PANDA | | |
|---|-----|--|--|--------------------|
|  | 17→ | Fanale posteriore 3° stop <i>Additional stop lamp</i> | | 1.04.218.00 |
| | | | | |

| FIAT | | NUOVA PANDA | | |
|---|-----|---------------------------------------|---|--------------------|
|  | 12→ | Fanale posteriore <i>Rear lamp</i> | → | 5.04.216.00 |
| | | Fanale posteriore <i>Rear lamp</i> | ← | 5.04.217.00 |
| | | | | |

| FIAT | | NUOVA PANDA | | |
|---|-----|---|---|--------------------|
|  | 12→ | Fanale posteriore retromarcia <i>Rear reverse lamp</i> | → | 1.04.064.00 |
| | | Fanale posteriore retronebbia <i>Rear fog lamp</i> | ← | 1.04.065.00 |
| | | | | |

| FIAT | | PUNTO EVO | | |
|---|-------------------|---|---|--------------------|
|  | 09→ | Fanale posteriore retromarcia <i>Rear reverse lamp</i> | ➔ | 1.04.112.00 |
| | | Fanale posteriore retronebbia <i>Rear fog lamp</i> | ➔ | 1.04.113.00 |
| | 3 porte 3 doors | | | |

| FIAT | | PUNTO EVO | | |
|---|--|---------------------------------------|---|--------------------|
|  | 12→ | Fanale posteriore <i>Rear lamp</i> | ➔ | 5.04.182.00 |
| | | Fanale posteriore <i>Rear lamp</i> | ➔ | 5.04.183.00 |
| | Cornice interna rossa <i>Red frame</i> | | | |

| FIAT | | PUNTO EVO | | |
|---|---|---------------------------------------|---|--------------------|
|  | 12→ | Fanale posteriore <i>Rear lamp</i> | ➔ | 5.04.200.00 |
| | | Fanale posteriore <i>Rear lamp</i> | ➔ | 5.04.201.00 |
| | Cornice interna nera <i>Black frame</i> | | | |

| FIAT | | PUNTO EVO | | |
|---|-----|--|---|--------------------|
|  | →12 | Cablaggio per fanale posteriore <i>Rear lamp wiring</i> | ➔ | 5.04.182.19 |
| | | Cablaggio per fanale posteriore <i>Rear lamp wiring</i> | ➔ | 5.04.183.19 |
| | | | | |

| FIAT | | GRANDE PUNTO | | |
|---|-----|---------------------------------------|---|--------------------|
|  | 05→ | Fanale posteriore <i>Rear lamp</i> | ➔ | 5.04.084.00 |
| | | Fanale posteriore <i>Rear lamp</i> | ➔ | 5.04.085.00 |
| | | | | |

| FIAT | | GRANDE PUNTO | | |
|---|-----|---|---|--------------------|
|  | 05→ | Fanale posteriore retromarcia <i>Rear reverse lamp</i> | → | 5.04.086.00 |
| | | Fanale posteriore retronebbia <i>Rear fog lamp</i> | ← | 5.04.087.00 |
| | | | | |

| FIAT | | SCUDO | | |
|---|---|--|---|--------------------|
|  | 95→06 | Gruppo ottico posteriore <i>Rear optical unit</i> | → | 2.04.058.10 |
| | | Gruppo ottico posteriore <i>Rear optical unit</i> | ← | 2.04.059.10 |
| | * Ricambio di qualità equivalente <i>Matching quality spare parts</i> | | | |

| FIAT | | SCUDO | | |
|---|---|---------------------------------------|--------------------|--------------------|
|  | 07→ | Fanale posteriore <i>Rear lamp</i> | → | 5.04.154.00 |
| | | Fanale posteriore <i>Rear lamp</i> | ← | 5.04.155.00 |
| | Gruppo ottico posteriore <i>Rear optical unit</i> | → | 2.04.102.10 | |
| | | ← | 2.04.103.10 | |
| | * Ricambio di qualità equivalente <i>Matching quality spare parts</i> | | | |

| FIAT | | STILO | | |
|---|--------------------------|---------------------------------------|---|--------------------|
|  | 01→ | Fanale posteriore <i>Rear lamp</i> | → | 5.04.068.00 |
| | | Fanale posteriore <i>Rear lamp</i> | ← | 5.04.069.00 |
| | 3 porte <i>3 doors</i> | | | |

| FIAT | | STILO SW | | |
|---|-----|--|---|--------------------|
|  | 03→ | Fanale posteriore esterno <i>External rear lamp</i> | → | 5.04.056.00 |
| | | Fanale posteriore esterno <i>External rear lamp</i> | ← | 5.04.057.00 |
| | | | | |

| FIAT | STILO | | |
|---|-------|--|--------------------|
|  | 01→03 | Fanale posteriore 3° stop <i>Additional stop lamp</i> | 1.04.090.00 |
| | | 3-5 porte 3-5 doors | |

| FIAT | TIPO BERLINA SEDAN | | |
|---|--------------------|--|----------------------|
|  | 16→ | Fanale posteriore esterno <i>External rear lamp</i> | ➔ 5.04.254.00 |
| | | Fanale posteriore esterno <i>External rear lamp</i> | ➜ 5.04.255.00 |
| | | | |

| FIAT | EGEA-TIPO BERLINA | | |
|---|-------------------|---|----------------------|
|  | 15→ | Gruppo ottico posteriore esterno <i>External rear optical unit</i> | ➔ 2.04.114.10 |
| | | Gruppo ottico posteriore esterno <i>External rear optical unit</i> | ➜ 2.04.115.10 |
| | | * Ricambio di qualità equivalente Matching quality spare parts | |

| FIAT | TIPO BERLINA SEDAN | | |
|---|--------------------|--|----------------------|
|  | 15→ | Fanale posteriore interno <i>Internal rear lamp</i> | ➔ 5.04.256.00 |
| | | Fanale posteriore interno <i>Internal rear lamp</i> | ➜ 5.04.257.00 |
| | | | |

| FIAT | TIPO SW | | |
|---|---------|---|----------------------|
|  | 16→ | Fanale posteriore retronebbia <i>Rear fog lamp</i> | ➔ 1.04.212.00 |
| | | Fanale posteriore retronebbia <i>Rear fog lamp</i> | ➜ 1.04.213.00 |
| | | | |

| FIAT | | TIPO SW | | |
|---|-------|--|---|--------------------|
|  | 16→20 | Fanale posteriore esterno <i>External rear lamp</i> | ➔ | 1.04.208.00 |
| | | Fanale posteriore esterno <i>External rear lamp</i> | ➜ | 1.04.209.00 |

| FIAT | | TIPO SW | | |
|---|-------|--|---|--------------------|
|  | 16→20 | Fanale posteriore interno <i>Internal rear lamp</i> | ➔ | 1.04.210.00 |
| | | Fanale posteriore interno <i>Internal rear lamp</i> | ➜ | 1.04.211.00 |

| FIAT | | TIPO SW | | |
|---|-------|--|---|--------------------|
|  | 16→20 | Fanale posteriore esterno fumè <i>Fumè external rear lamp</i> | ➔ | 1.04.278.00 |
| | | Fanale posteriore esterno fumè <i>Fumè external rear lamp</i> | ➜ | 1.04.279.00 |

| FIAT | | TIPO SW | | |
|---|-------|--|---|--------------------|
|  | 16→20 | Fanale posteriore interno fumè <i>Fumè internal rear lamp</i> | ➔ | 1.04.280.00 |
| | | Fanale posteriore interno fumè <i>Fumè internal rear lamp</i> | ➜ | 1.04.281.00 |





| FIAT | | TIPO SW CROSS | | LED |
|---|-----|--|---|--------------------|
|  | 21→ | Fanale posteriore esterno <i>External rear lamp</i> | ➔ | 1.04.326.80 |
| | | Fanale posteriore esterno <i>External rear lamp</i> | ➜ | 1.04.327.80 |

| FIAT | | TIPO SW CROSS | | LED |
|---|-----|--|---|--------------------|
|  | 21→ | Fanale posteriore interno <i>Internal rear lamp</i> | → | 1.04.328.80 |
| | | Fanale posteriore interno <i>Internal rear lamp</i> | ← | 1.04.329.80 |
| | | | | |

| FIAT | | UNO | | |
|---|-----|--|---|--------------------|
|  | →89 | Fanale posteriore <i>Rear lamp</i> | → | 2.04.068.00 |
| | | Fanale posteriore <i>Rear lamp</i> | ← | 2.04.069.00 |
| | →89 | Trasparente posteriore <i>Rear lens</i> | → | 2.04.068.20 |
| | | Trasparente posteriore <i>Rear lens</i> | ← | 2.04.069.20 |
| | | | * Ricambio di qualità equivalente Matching quality spare parts | |

| FIAT | | UNO RESTYLING | | |
|---|-------|--|---|--------------------|
|  | 89→94 | Fanale posteriore <i>Rear lamp</i> | → | 2.04.054.00 |
| | | Fanale posteriore <i>Rear lamp</i> | ← | 2.04.055.00 |
| | | Trasparente posteriore <i>Rear lens</i> | → | 2.04.054.20 |
| | | Trasparente posteriore <i>Rear lens</i> | ← | 2.04.055.20 |
| | | | * Ricambio di qualità equivalente Matching quality spare parts | |

| FIAT | | VARIE | | |
|---|--|--|--------|--------------------|
|  | | Fanale posteriore retromarcia incolore <i>Clear rear reverse lamp</i> | → ← | 2.04.064.00 |
| | | Trasparente posteriore incolore <i>Clear rear lens</i> | → ← | 2.04.064.22 |
| | | * Ricambio di qualità equivalente Matching quality spare parts | | |

| FIAT | | VARIE | | |
|---|---|---|--|--------------------|
|  | | Fanale posteriore retronebbia rosso <i>Red rear fog lamp</i> |   | 2.04.066.00 |
| | | Trasparente posteriore rosso <i>Red rear lens</i> |   | 2.04.066.21 |
| | * Ricambio di qualità equivalente Matching quality spare parts | | | |
| FORD | | FOCUS II | | |
|  | 04→08 | Fanale posteriore <i>Rear lamp</i> |  | 2021001025 |
| | | Fanale posteriore <i>Rear lamp</i> |  | 2021101025 |
| |  | | | |
| FORD | | FOCUS II SW | | |
|  | 04→11 | Gruppo ottico posteriore <i>Rear optical unit</i> |  | 2021001102 |
| | | Gruppo ottico posteriore <i>Rear optical unit</i> |  | 2021101102 |
| |  | | | |
| FORD | | FOCUS II SW | | LED |
|  | 04→11 | Gruppo ottico posteriore <i>Rear optical unit</i> |  | 2021001104 |
| | | Gruppo ottico posteriore <i>Rear optical unit</i> |  | 2021101104 |
| | Con luce posizione a LED <i>With LED position lamp</i> | | | |
| FORD | | FOCUS II | | |
|  | 04→11 | Gruppo ottico posteriore <i>Rear optical unit</i> |  | 2021001105 |
| | | Gruppo ottico posteriore <i>Rear optical unit</i> |  | 2021101105 |
| | 3-5 porte <i>3-5 doors</i> | | | |

| FORD | | FOCUS III | |
|---|-----|---------------------------------------|---------------------|
|  | 11→ | Fanale posteriore <i>Rear lamp</i> | ➔ 2021001119 |
| | | Fanale posteriore <i>Rear lamp</i> | ➜ 2021101119 |
| | | | |

| FORD | | FUSION | |
|---|-----|--|---------------------|
|  | 05→ | Gruppo ottico posteriore <i>Rear optical unit</i> | ➔ 2021001031 |
| | | Gruppo ottico posteriore <i>Rear optical unit</i> | ➜ 2021101031 |
| | | | |

| FORD | | MONDEO IV | |
|---|-------------------|---|---------------------|
|  | 07→ | Gruppo ottico posteriore interno <i>Internal rear optical unit</i> | ➔ 2021001052 |
| | | Gruppo ottico posteriore interno <i>Internal rear optical unit</i> | ➜ 2021101052 |
| | 4 porte 4 doors | | |

| FORD | | MONDEO IV TOURNIER | |
|---|-------------------|---|---------------------|
|  | 07→ | Gruppo ottico posteriore interno <i>Internal rear optical unit</i> | ➔ 2021001050 |
| | | Gruppo ottico posteriore interno <i>Internal rear optical unit</i> | ➜ 2021101050 |
| | 5 porte 5 doors | | |

| JEEP | | RENEGADE | |
|---|-----|---------------------------------------|----------------------|
|  | 14→ | Fanale posteriore <i>Rear lamp</i> | ➔ 5.04.250.00 |
| | | Fanale posteriore <i>Rear lamp</i> | ➜ 5.04.251.00 |
| | | | |

| JEEP | | RENEGADE | |
|---|-----|---|----------------------|
|  | 14→ | Fanale posteriore retrorarcia <i>Rear reverse lamp</i> | ➔ 1.04.194.00 |
| | | Fanale posteriore retronebbia <i>Rear fog lamp</i> | ➜ 1.04.195.00 |
| | | | |

| LAMBORGHINI | | HURACAN | |
|---|-----|---------------------------------------|----------------------|
|  | 12→ | Fanale posteriore <i>Rear lamp</i> | ➔ 1.04.282.00 |
| | | Fanale posteriore <i>Rear lamp</i> | ➜ 1.04.283.00 |
| | | | |

| LANCIA | | MUSA NUOVO DOMINO | |
|---|-------|--|----------------------|
|  | 04→07 | Gruppo ottico posteriore <i>Rear optical unit</i> | ➔ 1.04.080.10 |
| | | Gruppo ottico posteriore <i>Rear optical unit</i> | ➜ 1.04.081.10 |
| | | Portalampane <i>Bulb holder</i> | ➔ 1.04.080.18 |
| | | Portalampane <i>Bulb holder</i> | ➜ 1.04.081.18 |
| | | | |

| LANCIA | | MUSA | | LED | |
|---|-----|---------------------------------------|---|--------------------|--|
|  | 07→ | Fanale posteriore <i>Rear lamp</i> | ➔ | 5.04.110.00 | |
| | | Fanale posteriore <i>Rear lamp</i> | ➜ | 5.04.111.00 | |
| | | | | | |

| LANCIA | | MUSA | |
|---|-----|---|----------------------|
|  | 07→ | Fanale posteriore retrorarcia <i>Rear reverse lamp</i> | ➔ 5.04.086.00 |
| | | Fanale posteriore retronebbia <i>Rear fog lamp</i> | ➜ 5.04.087.00 |
| | | | |

| LANCIA | | MUSA FL | |
|---|-----|--|--------------------|
|  | 07→ | Fanale posteriore 3° stop <i>Additional stop lamp</i> | 1.04.116.00 |
| | | | |

| LANCIA | | NUOVA DELTA | |
|---|-----|---------------------------------------|----------------------|
|  | 08→ | Fanale posteriore <i>Rear lamp</i> | ➔ 1.04.106.00 |
| | | Fanale posteriore <i>Rear lamp</i> | ➔ 1.04.107.00 |
| | | | |



| LANCIA | | NUOVA DELTA | |
|---|-----|---|----------------------|
|  | 08→ | Fanale posteriore retromarcia <i>Rear reverse lamp</i> | ➔ 1.04.108.00 |
| | | Fanale posteriore retronebbia <i>Rear fog lamp</i> | ➔ 1.04.109.00 |
| | | | |

| LANCIA | | NUOVA DELTA | |
|---|-----|--|--------------------|
|  | 08→ | Fanale posteriore 3° Stop <i>Additional stop lamp</i> | 1.04.110.00 |
| | | | |

| LANCIA | | YPSILON MUSA | |
|---|-----|--|--------------------|
|  | 03→ | Fanale posteriore 3° Stop <i>Additional stop lamp</i> | 1.04.092.00 |
| | | | |

| LANCIA | | YPSILON | | |
|---|-------|--|---|--------------------|
|  | 06→11 | Gruppo ottico posteriore <i>Rear optical unit</i> | ➔ | 1.04.078.10 |
| | | Gruppo ottico posteriore <i>Rear optical unit</i> | ➜ | 1.04.079.10 |
| | | Portalampane <i>Bulb holder</i> | ➔ | 1.04.078.18 |
| | | Portalampane <i>Bulb holder</i> | ➜ | 1.04.079.18 |
| | | | | |

| LANCIA | | YPSILON | | LED |
|---|-----|---------------------------------------|---|--------------------|
|  | 11→ | Fanale posteriore <i>Rear lamp</i> | ➔ | 5.04.214.00 |
| | | Fanale posteriore <i>Rear lamp</i> | ➜ | 5.04.215.00 |
| | | 5 porte 5 doors | | |

| LAND ROVER | | FREELANDER 2 | | |
|---|-----|---|---|-------------------|
|  | 07→ | Fanale posteriore <i>Rear lamp</i> | ➔ | 2021001045 |
| | | Fanale posteriore <i>Rear lamp</i> | ➜ | 2021101045 |
| | |  | | |

| MASERATI | | GHIBLI (M157) | | |
|---|-----|--|---|--------------------|
|  | 13→ | Fanale posteriore esterno <i>External rear lamp</i> | ➔ | 1.04.224.00 |
| | | Fanale posteriore esterno <i>External rear lamp</i> | ➜ | 1.04.225.00 |
| | | | | |

| MASERATI | | GHIBLI (M157) | |
|---|-----|--|----------------------|
|  | 13→ | Fanale posteriore interno <i>Internal rear lamp</i> | ➔ 1.04.226.00 |
| | | Fanale posteriore interno <i>Internal rear lamp</i> | ➔ 1.04.227.00 |
| | | | |

| MASERATI | | GHIBLI (M157R) | |
|---|-----|--|----------------------|
|  | 19→ | Fanale posteriore esterno <i>External rear lamp</i> | ➔ 1.04.228.00 |
| | | Fanale posteriore esterno <i>External rear lamp</i> | ➔ 1.04.229.00 |
| | | | |

| MASERATI | | GHIBLI (M157R) | |
|---|-----|--|----------------------|
|  | 19→ | Fanale posteriore interno <i>Internal rear lamp</i> | ➔ 1.04.230.00 |
| | | Fanale posteriore interno <i>Internal rear lamp</i> | ➔ 1.04.231.00 |
| | | | |

| MASERATI | | GHIBLI (M157R) | |
|---|-----|---|----------------------|
|  | 19→ | Fanale posteriore esterno nero <i>Black external rear lamp</i> | ➔ 1.04.310.00 |
| | | Fanale posteriore esterno nero <i>Black external rear lamp</i> | ➔ 1.04.311.00 |
| | | | |

| MASERATI | | GHIBLI (M157R) | |
|---|-----|---|----------------------|
|  | 19→ | Fanale posteriore interno nero <i>Black internal rear lamp</i> | ➔ 1.04.312.00 |
| | | Fanale posteriore interno nero <i>Black internal rear lamp</i> | ➔ 1.04.313.00 |
| | | | |





| MERCEDES | | CLASSE A (W 176) | | |
|----------|-----|---------------------------------------|---|--------------------|
| | 15→ | Fanale posteriore <i>Rear lamp</i> | → | 1.04.220.00 |
| | | Fanale posteriore <i>Rear lamp</i> | ← | 1.04.221.00 |
| | | | | |

| MERCEDES | | CLASSE A (W 176) | | FULL LED |
|----------|-----|---------------------------------------|---|--------------------|
| | 15→ | Fanale posteriore <i>Rear lamp</i> | → | 1.04.222.00 |
| | | Fanale posteriore <i>Rear lamp</i> | ← | 1.04.223.00 |
| | | | | |

| MERCEDES | | CLASSE A (W 176) UK | | FULL LED |
|----------|-----|---------------------------------------|-------------------------|--------------------|
| | 15→ | Fanale posteriore <i>Rear lamp</i> | → | 1.04.234.06 |
| | | Fanale posteriore <i>Rear lamp</i> | ← | 1.04.235.06 |
| | | | <i>Right hand drive</i> | |

| MERCEDES | | CLASSE G | | |
|----------|-----|--|--------|--------------------|
| | 18→ | Fanale posteriore <i>night pack</i> <i>Night pack rear lamp</i> | → ← | 1.04.284.00 |
| | | | | |

| MERCEDES | | CLASSE G USA | | |
|----------|-----|--|--------|--------------------|
| | 18→ | Fanale posteriore <i>night pack</i> <i>Night pack rear lamp</i> | → ← | 1.04.285.06 |
| | | | | |

| MERCEDES | | CLASSE G | | |
|---|-------|--|---|--------------------|
|  | 18→ | Fanale posteriore <i>Rear lamp</i> | ↔ | 1.04.286.00 |
| | | | | |
| MERCEDES | | CLASSE G USA | | |
|  | 18→ | Fanale posteriore <i>Rear lamp</i> | ↔ | 1.04.287.06 |
| | | | | |
| MINI | | CLUBMAN (F54) | | |
|  | 13→18 | Fanale posteriore con posizione a led <i>Rear lamp with led parking light</i> | ↔ | 1.04.264.00 |
| | | Fanale posteriore con posizione a led <i>Rear lamp with led parking light</i> | ↔ | 1.04.265.00 |
| | | | | |
| MINI | | CLUBMAN (F54) | | |
|  | 13→18 | Fanale posteriore <i>Rear lamp</i> | ↔ | 1.04.266.00 |
| | | Fanale posteriore <i>Rear lamp</i> | ↔ | 1.04.267.00 |
| | | | | |
| MINI | | CLUBMAN (F54) | | |
|  | 13→18 | Fanale posteriore retronebbia <i>Rear fog lamp</i> | ↔ | 1.04.268.00 |
| | | Fanale posteriore retronebbia <i>Rear fog lamp</i> | ↔ | 1.04.269.00 |
| | | | | |

| MINI | | COOPER/ONE (F56) | | |
|---|-------|--|---|--------------------|
|  | 13→18 | Fanale posteriore con posizione a led <i>Rear lamp with parking led light</i> | ➔ | 1.04.258.00 |
| | | Fanale posteriore con posizione a led <i>Rear lamp with parking led light</i> | ➜ | 1.04.259.00 |
| | | | | |

| MINI | | COOPER/ONE (F56) | | |
|---|-------|---------------------------------------|---|--------------------|
|  | 13→18 | Fanale posteriore <i>Rear lamp</i> | ➔ | 1.04.260.00 |
| | | Fanale posteriore <i>Rear lamp</i> | ➜ | 1.04.261.00 |
| | | | | |

| MINI | | COOPER/ONE (F56) | | |
|---|-------|---|---|--------------------|
|  | 13→18 | Fanale posteriore retronebbia <i>Rear fog lamp</i> | ➔ | 1.04.262.00 |
| | | Fanale posteriore retronebbia <i>Rear fog lamp</i> | ➜ | 1.04.263.00 |
| | | | | |

| MINI | | COUNTRYMAN (F60) | | |
|---|-------|--|---|--------------------|
|  | 16→18 | Fanale posteriore con posizione a led con retromarcia <i>Rear reverse lamp with led parking light</i> | ➔ | 1.04.270.00 |
| | | Fanale posteriore con posizione a led con retromarcia <i>Rear reverse lamp with led parking light</i> | ➜ | 1.04.271.00 |
| | | | | |

| MINI | | COUNTRYMAN (F60) | | |
|---|-------|---|---|--------------------|
|  | 16→18 | Fanale posteriore con retromarcia <i>Rear reverse lamp</i> | ➔ | 1.04.272.00 |
| | | Fanale posteriore con retronebbia <i>Rear fog lamp</i> | ➜ | 1.04.273.00 |
| | | | | |

| MINI | | COUNTRYMAN (F60) UK | | |
|---|-------|--|---|--------------------|
|  | 16→18 | Fanale posteriore con posizione a led con retronebbia <i>Rear fog lamp with led parking light</i> | → | 1.04.270.06 |
| | | Fanale posteriore con posizione a led con retronebbia <i>Rear fog lamp with led parking light</i> | ← | 1.04.271.06 |
| | | <i>Right hand drive</i> | | |

| MINI | | COUNTRYMAN (F60) UK | | |
|---|-------|---|---|--------------------|
|  | 16→18 | Fanale posteriore con retromarcia <i>Rear reverse lamp</i> | → | 1.04.272.06 |
| | | Fanale posteriore con retromarcia <i>Rear reverse lamp</i> | ← | 1.04.273.06 |
| | | <i>Right hand drive</i> | | |

| MINI | | UNION JACK (F56 LCI) | | |
|---|-------|---------------------------------------|---|--------------------|
|  | 13→18 | Fanale posteriore <i>Rear lamp</i> | → | 1.04.232.00 |
| | | Fanale posteriore <i>Rear lamp</i> | ← | 1.04.233.00 |
| | | | | |

| MINI | | UNION JACK (F56 LCI) USA | | |
|---|-------|---------------------------------------|---|--------------------|
|  | 13→18 | Fanale posteriore <i>Rear lamp</i> | → | 1.04.232.16 |
| | | Fanale posteriore <i>Rear lamp</i> | ← | 1.04.233.16 |
| | | | | |

| MINI | | CLUBMAN (R55) | | |
|---|-----|---|---|--------------------|
|  | →10 | Fanale posteriore direzione arancio <i>Rear lamp with orange repeater lamp</i> | → | 1.04.126.00 |
| | | Fanale posteriore direzione arancio <i>Rear lamp with orange repeater lamp</i> | ← | 1.04.127.00 |
| | | | | |

| MINI | | CLUBMAN (R55) | |
|------|--|---|----------------------|
| | 10→ | Fanale posteriore direzione incolore <i>Rear lamp with clear repeater lamp</i> | ➔ 1.04.128.00 |
| | | Fanale posteriore direzione incolore <i>Rear lamp with clear repeater lamp</i> | ➜ 1.04.129.00 |
| | Versione con guide ottiche LED <i>Version with LED lamp guides</i> | | |
| MINI | | CLUBMAN RESTYLING (R55) | |
| | 10→ | Fanale posteriore direzione arancio <i>Rear lamp with orange repeater lamp</i> | ➔ 1.04.166.00 |
| | | Fanale posteriore direzione arancio <i>Rear lamp with orange repeater lamp</i> | ➜ 1.04.167.00 |
| | Versione con guide ottiche LED <i>Version with LED lamp guides</i> | | |
| MINI | | CLUBMAN RESTYLING (R55) | |
| | 10→ | Fanale posteriore direzione incolore <i>Rear lamp with clear repeater lamp</i> | ➔ 1.04.170.00 |
| | | Fanale posteriore direzione incolore <i>Rear lamp with clear repeater lamp</i> | ➜ 1.04.171.00 |
| | Versione con guide ottiche LED <i>Version with LED lamp guides</i> | | |
| MINI | | CLUBMAN RESTYLING (R55) UK | |
| | 10→ | Fanale posteriore direzione incolore <i>Rear lamp with clear repeater lamp</i> | ➔ 1.04.172.06 |
| | | Fanale posteriore direzione incolore <i>Rear lamp with clear repeater lamp</i> | ➜ 1.04.173.06 |
| | Versione con LED lamp guides <i>Right hand drive</i> | | |
| MINI | | COOPER (R56) | |
| | 10→ | Fanale posteriore direzione arancio <i>Rear lamp with orange repeater lamp</i> | ➔ 1.04.118.00 |
| | | Fanale posteriore direzione arancio <i>Rear lamp with orange repeater lamp</i> | ➜ 1.04.119.00 |
| | Versione con guide ottiche LED <i>Version with LED lamp guides</i> | | |

| MINI | | COOPER (R56) | | |
|---|-----|---|---|--------------------|
|  | 10→ | Fanale posteriore direzione incolore <i>Rear lamp with clear repeater lamp</i> | ➔ | 1.04.120.00 |
| | | Fanale posteriore direzione incolore <i>Rear lamp with clear repeater lamp</i> | ➜ | 1.04.121.00 |
| | | | | |

| MINI | | COOPER (R56) USA | | |
|---|-----|---|---|--------------------|
|  | 10→ | Fanale posteriore direzione incolore <i>Rear lamp with clear repeater lamp</i> | ➔ | 1.04.288.16 |
| | | Fanale posteriore direzione incolore <i>Rear lamp with clear repeater lamp</i> | ➜ | 1.04.289.16 |
| | | | | |

| MINI | | COOPER (R56) | | |
|---|-------|-------------------------|---|--------------------|
|  | 06→12 | Cornice <i>Frame</i> | ➔ | 1.04.118.17 |
| | | Cornice <i>Frame</i> | ➜ | 1.04.119.17 |
| | | | | |

| MINI | | COOPER (R56 R56N R57) | | |
|---|-----|---|---|--------------------|
|  | 08→ | Fanale posteriore retromarcia e retronebbia <i>Rear fog and reverse lamp</i> | ➔ | 1.04.124.00 |
| | | Fanale posteriore retromarcia e retronebbia <i>Rear fog and reverse lamp</i> | ➜ | 1.04.125.00 |
| | | | | |

| MINI | | COOPER (R56) ONE DIESEL | | |
|---|-----|--|--|--------------------|
|  | 07→ | Fanale posteriore retronebbia centrale <i>Rear central fog lamp</i> | | 1.04.122.00 |
| | | | | |

| MINI | | COOPER (R56N) | | |
|---|--|---|---|--------------------|
|  | 10→ | Fanale posteriore direzione arancio <i>Rear lamp with orange repeater lamp</i> | ➔ | 1.04.174.00 |
| | | Fanale posteriore direzione arancio <i>Rear lamp with orange repeater lamp</i> | ➜ | 1.04.175.00 |
| | Versione con guide ottiche LED <i>Version with LED lamp guides</i> | | | |

| MINI | | COOPER (R56N) | | |
|---|--|---|---|--------------------|
|  | 10→ | Fanale posteriore direzione incolore <i>Rear lamp with clear repeater lamp</i> | ➔ | 1.04.176.00 |
| | | Fanale posteriore direzione incolore <i>Rear lamp with clear repeater lamp</i> | ➜ | 1.04.177.00 |
| | Versione con guide ottiche LED <i>Version with LED lamp guides</i> | | | |

| MINI | | COOPER D (R56N) | | |
|---|-----|---|--|--------------------|
|  | 08→ | Fanale posteriore retronebbia e retromarcia <i>Rear fog and reverse lamp</i> | | 1.04.178.00 |
| | | | | |

| MINI | | COOPER (R56N R57) | | |
|---|-----|---|--|--------------------|
|  | 08→ | Fanale posteriore retronebbia <i>Rear reverse lamp</i> | | 1.04.122.00 |
| | | | | |

| MINI | | COUNTRYMAN (R60) | | |
|---|-----|---------------------------------------|---|--------------------|
|  | 10→ | Fanale posteriore <i>Rear lamp</i> | ➔ | 1.04.180.00 |
| | | Fanale posteriore <i>Rear lamp</i> | ➜ | 1.04.181.00 |
| | | | | |





| MINI | | COUNTRYMAN (R60) UK | |
|---|-------------------------|---------------------------------------|----------------------|
|  | 10→ | Fanale posteriore <i>Rear lamp</i> | ➔ 1.04.182.06 |
| | | Fanale posteriore <i>Rear lamp</i> | ➜ 1.04.183.06 |
| | <i>Right hand drive</i> | | |

| MINI | | COUNTRYMAN (R60) | |
|---|-----|---|----------------------|
|  | 10→ | Cornice cromata <i>Chrome-plated frame</i> | ➔ 1.04.180.17 |
| | | Cornice cromata <i>Chrome-plated frame</i> | ➜ 1.04.181.17 |
| | | | |

| OPEL | | ASTRA H | |
|---|-----|---------------------------------------|---------------------|
|  | 04→ | Fanale posteriore <i>Rear lamp</i> | ➔ 2021001049 |
| | | Fanale posteriore <i>Rear lamp</i> | ➜ 2021101049 |
| | | | |

| PEUGEOT | | 207 CC | |
|---|-----|---------------------------------------|---------------------|
|  | 07→ | Fanale posteriore <i>Rear lamp</i> | ➔ 2021001037 |
| | | Fanale posteriore <i>Rear lamp</i> | ➜ 2021101037 |
| | | | |

| PEUGEOT | | 207 SW | |
|---|-----|---------------------------------------|---------------------|
|  | 07→ | Fanale posteriore <i>Rear lamp</i> | ➔ 2021001038 |
| | | Fanale posteriore <i>Rear lamp</i> | ➜ 2021101038 |
| | | | |

| PEUGEOT | | PARTNER | |
|---|-----|--|----------------------|
|  | 08→ | Fanale posteriore <i>Rear lamp</i> | → 5.04.180.00 |
| | | Fanale posteriore <i>Rear lamp</i> | ← 5.04.181.00 |
| | | 2 porte 2 doors | |
| PORSCHE | | 991 | LED |
|  | | Fanale posteriore <i>Rear lamp</i> | → 1.04.290.00 |
| | | Fanale posteriore <i>Rear lamp</i> | ← 1.04.291.00 |
| | | | |
| PORSCHE | | 991 EXCLUSIVE | LED |
|  | | Fanale posteriore <i>Rear lamp</i> | → 1.04.292.00 |
| | | Fanale posteriore <i>Rear lamp</i> | ← 1.04.293.00 |
| | | | |
| PORSCHE | | 991 EXCLUSIVE | LED |
|  | | Fanale posteriore fascione <i>Rear lamp</i> | 1.04.294.00 |
| | | | |
| | | | |
| RENAULT | | MEGANE III LAGUNA | |
|  | 08→ | Fanale posteriore <i>Rear lamp</i> | → 1.04.184.00 |
| | | Fanale posteriore <i>Rear lamp</i> | ← 1.04.185.00 |
| | | | |

| RENAULT | | SCENIC | |
|---|-----|---|----------------------|
|  | 12→ | Fanale posteriore retronebbia <i>Rear fog lamp</i> | ➔ 1.04.148.00 |
| | | Fanale posteriore retromarcia <i>Rear reverse lamp</i> | ➜ 1.04.149.00 |

| ROLLS ROYCE | | RR2X GHOST | | LED | |
|---|-----|---------------------------------------|---|--------------------|--|
|  | 21→ | Fanale posteriore <i>Rear lamp</i> | ➔ | 1.04.298.80 | |
| | | Fanale posteriore <i>Rear lamp</i> | ➜ | 1.04.299.80 | |

| SEAT | | ALTEA XL | |
|---|-----|--|---------------------|
|  | 06→ | Fanale posteriore esterno <i>External rear lamp</i> | ➔ 2021001046 |
| | | Fanale posteriore esterno <i>External rear lamp</i> | ➜ 2021101046 |





| SKODA | | FABIA III | |
|---|-----|--|---------------------|
|  | 06→ | Gruppo ottico posteriore <i>Rear optical unit</i> | ➔ 2021001047 |
| | | Gruppo ottico posteriore <i>Rear optical unit</i> | ➜ 2021101047 |

Berlina | Sedan 

| SKODA | | OCTAVIA 2 | |
|---|-----|--|---------------------|
|  | 04→ | Gruppo ottico posteriore <i>Rear optical unit</i> | ➔ 2021001019 |
| | | Gruppo ottico posteriore <i>Rear optical unit</i> | ➜ 2021101019 |





| SKODA | | SUPERB II | | |
|---|-----|--|---|--------------------|
|  | 13→ | Fanale posteriore esterno <i>External rear lamp</i> | → | 1.04.154.00 |
| | | Fanale posteriore esterno <i>External rear lamp</i> | ← | 1.04.155.00 |
| | | | | |

| SKODA | | SUPERB II | | |
|---|-----|--|---|--------------------|
|  | 13→ | Fanale posteriore interno <i>Internal rear lamp</i> | → | 1.04.156.00 |
| | | Fanale posteriore interno <i>Internal rear lamp</i> | ← | 1.04.157.00 |
| | | | | |

| SKODA | | SUPERB II UK | | |
|---|-----|--|-------------------------|--------------------|
|  | 13→ | Fanale posteriore interno <i>Internal rear lamp</i> | → | 1.04.158.00 |
| | | Fanale posteriore interno <i>Internal rear lamp</i> | ← | 1.04.159.00 |
| | | | <i>Right hand drive</i> | |

| SKODA | | SUPERB II SW | | |
|---|-----|---------------------------------------|---|--------------------|
|  | 13→ | Fanale posteriore <i>Rear lamp</i> | → | 1.04.160.00 |
| | | Fanale posteriore <i>Rear lamp</i> | ← | 1.04.161.00 |
| | | | | |

| SKODA | | SUPERB II UK | | |
|---|-----|---------------------------------------|-------------------------|--------------------|
|  | 13→ | Fanale posteriore <i>Rear lamp</i> | → | 1.04.162.00 |
| | | Fanale posteriore <i>Rear lamp</i> | ← | 1.04.163.00 |
| | | | <i>Right hand drive</i> | |





| TOYOTA | | AYGO FL | |
|---|-----|--|----------------------|
|  | 09→ | Gruppo ottico posteriore <i>Rear optical unit</i> | ➔ 5.04.208.10 |
| | | Gruppo ottico posteriore <i>Rear optical unit</i> | ➜ 5.04.209.10 |
| | | | |

| VOLKSWAGEN | | CADDY | |
|---|-----|---------------------------------------|----------------------|
|  | 20→ | Fanale posteriore <i>Rear lamp</i> | ➔ 1.04.338.00 |
| | | Fanale posteriore <i>Rear lamp</i> | ➜ 1.04.339.00 |
| | | | |

| VOLKSWAGEN | | CADDY | | LED |
|--|-----|---------------------------------------|---|--------------------|
|  | 20→ | Fanale posteriore <i>Rear lamp</i> | ➔ | 1.04.338.80 |
| | | Fanale posteriore <i>Rear lamp</i> | ➜ | 1.04.339.80 |
| | | | | |

| VOLKSWAGEN | | GOLF PLUS | |
|---|-----|--|----------------------|
|  | 05→ | Fanale posteriore esterno <i>External rear lamp</i> | ➔ 5.04.134.00 |
| | | Fanale posteriore esterno <i>External rear lamp</i> | ➜ 5.04.135.00 |
| | | | |

| VOLKSWAGEN | | ID.4 | | LED |
|---|-----|---|---|--------------------|
|  | 20→ | Fanale posteriore esterno con pannelli a led <i>External rear lamp with led panels</i> | ➔ | 1.04.344.80 |
| | | Fanale posteriore esterno con pannelli a led <i>External rear lamp with led panels</i> | ➜ | 1.04.345.80 |
| | | Paratia posteriore <i>Rear bezel</i> | ➔ | 1.04.348.17 |
| | | Paratia posteriore <i>Rear bezel</i> | ➜ | 1.04.349.17 |
| | | | | |

| VOLKSWAGEN | | ID.4 | LED |
|---|-----|--|------------------------------|
|  | 20→ | Fanale posteriore fascione con pannelli a led <i>Rear lamp with led panels</i> | ↔ ↔ 1.04.340.80 |
| | | | |
| VOLKSWAGEN | | ID.4 | |
|  | 20→ | Fanale posteriore esterno con guida luce a led <i>External rear lamp with led parking light</i> | → 1.04.346.00 |
| | | Fanale posteriore esterno con guida luce a led <i>External rear lamp with led parking light</i> | ← 1.04.347.00 |
| | | Paratia posteriore <i>Rear bezel</i> | → 1.04.348.17 |
| | | Paratia posteriore <i>Rear bezel</i> | ← 1.04.349.17 |
| | | | |
| VOLKSWAGEN | | ID.4 USA | |
|  | 20→ | Fanale posteriore esterno con guida luce a led <i>External rear lamp with led parking light</i> | → 1.04.346.16 |
| | | Fanale posteriore esterno con guida luce a led <i>External rear lamp with led parking light</i> | ← 1.04.347.16 |
| | | Paratia posteriore <i>Rear bezel</i> | → 1.04.348.17 |
| | | Paratia posteriore <i>Rear bezel</i> | ← 1.04.349.17 |
| | | | |
| VOLKSWAGEN | | ID.4 | LED |
|  | 20→ | Fanale posteriore fascione con guida luce a led <i>Rear lamp with led parking light</i> | ↔ ↔ 1.04.342.00 |
| | | | |

| VOLKSWAGEN | | MULTIVAN (T6) | | |
|---|-------------------|---------------------------------------|---|--------------------|
|  | 18→ | Fanale posteriore <i>Rear lamp</i> | ➔ | 1.04.350.00 |
| | | Fanale posteriore <i>Rear lamp</i> | ➜ | 1.04.351.00 |
| | 2 porte 2 doors | | | |

| VOLKSWAGEN | | MULTIVAN (T6) UK | | |
|---|-------------------|---------------------------------------|---|--------------------|
|  | 18→ | Fanale posteriore <i>Rear lamp</i> | ➔ | 1.04.350.06 |
| | | Fanale posteriore <i>Rear lamp</i> | ➜ | 1.04.351.06 |
| | 2 porte 2 doors | | | |
| <i>Right hand drive</i> | | | | |

| VOLKSWAGEN | | MULTIVAN (T6) | | LED |
|---|------------------|---------------------------------------|---|--------------------|
|  | 18→ | Fanale posteriore <i>Rear lamp</i> | ➔ | 1.04.352.80 |
| | | Fanale posteriore <i>Rear lamp</i> | ➜ | 1.04.353.80 |
| | 1 porta 1 door | | | |

| VOLKSWAGEN | | MULTIVAN (T6) | | LED |
|---|------------------|--|---|--------------------|
|  | 18→ | Fanale posteriore nero <i>Black rear lamp</i> | ➔ | 1.04.354.80 |
| | | Fanale posteriore nero <i>Black rear lamp</i> | ➜ | 1.04.355.80 |
| | 1 porta 1 door | | | |

| VOLKSWAGEN | | MULTIVAN (T6) | | |
|---|------------------|---------------------------------------|---|--------------------|
|  | 18→ | Fanale posteriore <i>Rear lamp</i> | ➔ | 1.04.356.00 |
| | | Fanale posteriore <i>Rear lamp</i> | ➜ | 1.04.357.00 |
| | 1 porta 1 door | | | |

| VOLKSWAGEN | | MULTIVAN (T6) UK | |
|---|-------------------------|---------------------------------------|----------------------|
|  | 18→ | Fanale posteriore <i>Rear lamp</i> | ➔ 1.04.356.06 |
| | | Fanale posteriore <i>Rear lamp</i> | ➔ 1.04.357.06 |
| | 1 porta 1 door | | |
| | <i>Right hand drive</i> | | |

| VOLKSWAGEN | | PASSAT BERLINA | | LED |
|---|-----|--|---|--------------------|
|  | 19→ | Fanale posteriore esterno <i>External rear lamp</i> | ➔ | 1.04.364.80 |
| | | Fanale posteriore esterno <i>External rear lamp</i> | ➔ | 1.04.365.80 |





| VOLKSWAGEN | | PASSAT BERLINA | | LED |
|---|-----|--|---|--------------------|
|  | 19→ | Fanale posteriore interno <i>Internal rear lamp</i> | ➔ | 1.04.362.80 |
| | | Fanale posteriore interno <i>Internal rear lamp</i> | ➔ | 1.04.363.80 |





| VOLKSWAGEN | | PASSAT BERLINA UK | | LED |
|---|-------------------------|--|---|--------------------|
|  | 19→ | Fanale posteriore interno <i>Internal rear lamp</i> | ➔ | 1.04.362.06 |
| | | Fanale posteriore interno <i>Internal rear lamp</i> | ➔ | 1.04.363.06 |
| | <i>Right hand drive</i> | | | |





| VOLKSWAGEN | | PASSAT VARIANT / SW | | LED |
|---|-----|--|---|--------------------|
|  | 19→ | Fanale posteriore esterno <i>External rear lamp</i> | ➔ | 1.04.360.80 |
| | | Fanale posteriore esterno <i>External rear lamp</i> | ➔ | 1.04.361.80 |





| VOLKSWAGEN | | PASSAT VARIANT / SW | | LED |
|---|-----|--|---|--------------------|
|  | 19→ | Fanale posteriore interno <i>Internal rear lamp</i> | → | 1.04.358.80 |
| | | Fanale posteriore interno <i>Internal rear lamp</i> | ← | 1.04.359.80 |
| | | | | |





| VOLKSWAGEN | | PASSAT VARIANT / SW UK | | LED |
|---|-----|--|---|--------------------|
|  | 19→ | Fanale posteriore interno <i>Internal rear lamp</i> | → | 1.04.358.06 |
| | | Fanale posteriore interno <i>Internal rear lamp</i> | ← | 1.04.359.06 |
| | | <i>Right hand drive</i> | | |







| ALFA ROMEO | | 147 | | | |
|---|-------|---|--------------------|-----|--|
|  | 00→04 | Fanale targa <i>Number plate light</i> | 1.05.052.00 | | |
| ALFA ROMEO | | 156 | | | |
|  | 97→03 | Fanale targa <i>Number plate light</i> | 1.05.054.00 | | |
| ALFA ROMEO | | 159 | | | |
|  | 00→04 | Fanale targa <i>Number plate light</i> | 1.05.104.00 | | |
| ALFA ROMEO | | GIULIA | | LED | |
|  | 16→ | Fanale targa <i>Number plate light</i> | 1.05.072.80 | | |
| ALFA ROMEO | | STELVIO | | LED | |
|  | 16→ | Fanale targa <i>Number plate light</i> | 1.05.080.80 | | |

| AUTOBIANCHI | | A 112 | |
|---|-------|------------------------------------|--------------------|
|  | 80→82 | Fanale targa Number plate light | 1.05.056.00 |
| <hr/> | | | |
| BMW | | | |
|  | | Fanale targa Number plate light | 1.05.112.00 |
| <hr/> | | | |
| BMW | | LED | |
|  | 19→ | Fanale targa Number plate light | 1.05.128.80 |
| <hr/> | | | |
| FIAT | | 500 | |
|  | 65→85 | Fanale targa Number plate light | 5.06.050.00 |
| <hr/> | | | |
| FIAT | | NUOVA 500L | |
|  | 12→ | Fanale targa Number plate light | 1.05.092.00 |
| <hr/> | | | |

| FIAT | | 127 3° SERIE | |
|---|-------|------------------------------------|--------------------|
|  | 82→83 | Fanale targa Number plate light | 1.05.056.00 |
| FIAT | | BRAVO BRAVA | |
|  | 95→01 | Fanale targa Number plate light | 1.05.062.00 |
| FIAT | | CINQUECENTO | |
|  | →98 | Fanale targa Number plate light | 1.05.064.00 |
| FIAT | | CROMA | |
|  | →06 | Fanale targa Number plate light | 1.05.106.00 |
| FIAT | | DOBLÒ MY 2009 | |
|  | 09→ | Fanale targa Number plate light | 1.05.120.00 |

| FIAT | | DOBLÒ | |
|---|--|------------------------------------|--------------------|
|  | 00→ | Fanale targa Number plate light | 1.05.074.00 |
| | | | |
| FIAT | | FIORINO | |
|  | 91→ | Fanale targa Number plate light | 2.05.050.00 |
| | * Ricambio di qualità equivalente Matching quality spare parts | | |
| FIAT | | FIORINO QUBO | |
|  | 07→ | Fanale targa Number plate light | 1.05.118.00 |
| | | | |
| FIAT | | MAREA SW MULTIPLA | |
|  | 98→04 | Fanale targa Number plate light | 1.05.054.00 |
| | | | |
| FIAT | | PANDA | |
|  | →03 | Fanale targa Number plate light | 1.05.056.00 |
| | | | |

| FIAT | | PUNTO | |
|---|-------|------------------------------------|--------------------|
|  | 99→ | Fanale targa Number plate light | 1.05.084.00 |
| FIAT | | SEICENTO | |
|  | 98→ | Fanale targa Number plate light | 1.05.096.00 |
| FIAT | | TEMPRA TIPO | |
|  | 90→96 | Fanale targa Number plate light | 1.05.070.00 |
| JEEP | | RENEGADE | |
|  | 14→ | Fanale targa Number plate light | 1.05.114.00 |
| LANCIA | | DEDRA | |
|  | 89→ | Fanale targa Number plate light | 1.05.070.00 |

| LANCIA | | K | |
|---|-------|---|--------------------|
|  | 94→ | Fanale targa Number plate light | 1.05.086.00 |
| LANCIA | | Y10 | |
|  | 92→ | Fanale targa Number plate light | 1.05.060.00 |
| LANCIA | | Y10 | |
|  | 93→96 | Fanale targa Number plate light | 1.05.058.00 |
| LANCIA | | YPSILON | |
|  | 03→ | Vetrino luce targa Number plate light small glass | 1.05.090.12 |
| MINI | | | |
|  | 01→06 | Fanale targa Number plate light | 1.05.116.12 |
|  | | Cablaggio con portalampane Wiring with bulb holder | 1.05.116.19 |

| | | | |
|---|-------|---|--------------------|
| OPEL | | ASTRA 3 5 PORTE CORSA VECTRA | |
|  | 06→ | Fanale targa <i>Number plate light</i> | 1.05.100.00 |
| OPEL | | CORSA MERIVA TIGRA | |
|  | →06 | Vetrino luce targa <i>Number plate light small glass</i> | 1.05.098.00 |
| PEUGEOT CITRÖEN | | PARTNER BERLINGO | |
|  | 09→ | Fanale targa <i>Number plate light</i> | 1.05.126.00 |
| PEUGEOT CITRÖEN | | PARTNER BERLINGO | |
|  | 09→ | Fanale targa <i>Number plate light</i> | 1.05.124.00 |
| RENAULT | | CLIO SCENIC MODUS | |
|  | | Fanale targa <i>Number plate light</i> | 1.05.110.00 |
| RENAULT | | KANGOO | |
|  | 07→13 | Fanale targa <i>Number plate light</i> | 1.05.122.00 |





| ALFA ROMEO | | 145 | | |
|---|-----|--------------------------|---|--------------------|
|  | 98→ | Catadriotto Reflector | ➔ | 1.06.076.00 |
| | | Catadriotto Reflector | ➜ | 1.06.077.00 |
| | | | | |

| ALFA ROMEO | | 147 | | |
|---|-------|--------------------------|---|--------------------|
|  | 00→04 | Catadriotto Reflector | ➔ | 1.06.052.00 |
| | | Catadriotto Reflector | ➜ | 1.06.053.00 |
| | | | | |

| ALFA ROMEO | | 156 | | |
|---|-----|--------------------------|---|--------------------|
|  | 97→ | Catadriotto Reflector | ➔ | 1.06.080.00 |
| | | Catadriotto Reflector | ➜ | 1.06.081.00 |
| | | | | |

| ALFA ROMEO | | 159 | | |
|---|-----|--------------------------|---|--------------------|
|  | 06→ | Catadriotto Reflector | ➔ | 1.06.078.00 |
| | | Catadriotto Reflector | ➜ | 1.06.079.00 |
| | | | | |

| CITRÖEN | | | | |
|---|-----|--------------------------|---|--------------------|
|  | 02→ | Catadriotto Reflector | ➔ | 1.06.086.00 |
| | | Catadriotto Reflector | ➜ | 1.06.087.00 |
| | | | | |



| FERRARI | | 488 | |
|---|-------|--------------------------|----------------------|
|  | | Catadriotto Reflector | ➔ 1.06.094.00 |
| | | Catadriotto Reflector | ➔ 1.06.095.00 |
| | | | |
| FIAT | | BRAVO MULTIPLA | |
|  | 95→01 | Catadriotto Reflector | ➔ 1.06.058.00 |
| | | Catadriotto Reflector | ➔ 1.06.059.00 |
| | | | |
| FIAT | | CROMA | |
|  | 06→ | Catadriotto Reflector | ➔ 1.06.074.00 |
| | | Catadriotto Reflector | ➔ 1.06.075.00 |
| | | | |
| FIAT | | 500 X | |
|  | 15→ | Catadriotto Reflector | ➔ 1.06.088.00 |
| | | Catadriotto Reflector | ➔ 1.06.089.00 |
| | | | |
| FIAT | | DOBLÒ 2009 | |
|  | 09→ | Catadriotto Reflector | ➔ 1.06.092.00 |
| | | Catadriotto Reflector | ➔ 1.06.093.00 |
| | | | |



| FIAT | | MAREA SW | | |
|---|-------|--------------------------|---|--------------------|
|  | 96→03 | Catadriotto Reflector | ➔ | 1.06.064.00 |
| | | Catadriotto Reflector | ➜ | 1.06.065.00 |
| | | | | |

| FIAT | | PUNTO | | |
|---|-----|--------------------------|---|--------------------|
|  | 03→ | Catadriotto Reflector | ➔ | 1.06.066.00 |
| | | Catadriotto Reflector | ➜ | 1.06.067.00 |
| | | 3-5 porte 3-5 doors | | |

| FIAT | | PUNTO SPORT | | |
|---|-----|--------------------------|---|--------------------|
|  | 03→ | Catadriotto Reflector | ➔ | 1.06.068.00 |
| | | Catadriotto Reflector | ➜ | 1.06.069.00 |
| | | | | |







| JEEP | | RENEGADE | | |
|---|-----|--|---|--------------------|
|  | 14→ | Catadriotto posteriore Rear reflector | ➔ | 1.06.090.00 |
| | | Catadriotto posteriore Rear reflector | ➜ | 1.06.091.00 |
| | | | | |

| LANCIA | | YPSILON | | |
|--|-----|--------------------------|---|--------------------|
|   | 06→ | Catadriotto Reflector | ➔ | 1.06.070.00 |
| | | Catadriotto Reflector | ➜ | 1.06.071.00 |
| | | | | |

| LANCIA | | YPSILON | | |
|---|-----|--|---|--------------------|
|  | 06→ | Catadriotto interno <i>Internal reflector</i> | | 1.06.070.01 |
| | | | | |
| MERCEDES | | VITO | | |
|  | 03→ | Catadriotto <i>Reflector</i> | → | 5.06.068.00 |
| | | Catadriotto <i>Reflector</i> | ← | 5.06.069.00 |
| | | | | |
| PEUGEOT | | VARIOUS MODELS | | |
|  | 02→ | Catadriotto <i>Reflector</i> | → | 1.06.086.00 |
| | | Catadriotto <i>Reflector</i> | ← | 1.06.087.00 |
| | | | | |

| FIAT | | PANDA | |
|---|-----------------------|-------------------------|--------------------|
|  | 03→ | Plafoniera Dome lamp | 1.08.056.00 |
| | Grigio 670 / Grey 670 | | |

| FIAT | | PANDA | |
|---|-----------------------|-------------------------|--------------------|
|  | 97→ | Plafoniera Dome lamp | 1.08.052.00 |
| | Grigio 669 / Grey 669 | | |

| ALFA ROMEO | | MITO | |
|---|-------|--|---|
|  | 08→ | Proiettore (H7+H7) con motorino <i>Headlamp (H7+H7) with small device</i> | ➔ 8.00.056.00 |
| | | Proiettore (H7+H7) con motorino <i>Headlamp (H7+H7) with small device</i> | ➔ 8.00.057.00 |
| | | | |
| CITROËN | | C3 | |
|  | 09→ | Proiettore (H7+H1) <i>Headlamp (H7+H1)</i> | ➔ 2020001105 |
| | | Proiettore (H7+H1) <i>Headlamp (H7+H1)</i> | ➔ 2020101105 |
| | | Parabola cromata con luce di curva dinamica <i>Chrome plated reflex-reflector with dynamic turn light</i> |  |
| CITROËN | | DS3 | |
|  | 09→ | Proiettore (H7+H1) con motorino <i>Headlamp (H7+H1) with small device</i> | ➔ 2020001107 |
| | | Proiettore (H7+H1) con motorino <i>Headlamp (H7+H1) with small device</i> | ➔ 2020101107 |
| | | Parabola nera <i>Black plated Reflex reflector</i> |  |
| FIAT | | 500 | |
|  | 65→ | Proiettore ASY con cornice <i>ASY Headlamp with frame</i> | ➔ 8.90.050.00 |
| | | Proiettore ASY senza cornice <i>ASY Headlamp without frame</i> | ➔ 8.90.052.00 |
| | | Cornice cromata <i>Chromed plated frame</i> | ➔ 8.90.050.17 |
| | | * Ricambio di qualità equivalente Parts of matching quality | |
| FIAT | | GRANDE PUNTO | |
|  | 05→08 | Proiettore (H4) con motorino <i>Headlamp (H4) with small device</i> | ➔ 8.00.064.00 |
| | | Proiettore (H4) con motorino <i>Headlamp (H4) with small device</i> | ➔ 8.00.065.00 |

| FIAT | | PANDA 750 | |
|---|--|---|----------------------|
|  | 86→03 | Proiettore ASY (R2) manuale con trasparente arancio <i>Manual headlamp ASY (R2) with orange lens</i> | ➔ 8.10.000.00 |
| | | Proiettore ASY (R2) manuale con trasparente arancio <i>Manual headlamp ASY (R2) with orange lens</i> | ➜ 8.10.001.00 |
| | * Ricambio di qualità equivalente Parts of matching quality | | |

| FIAT | | PANDA 750 | |
|---|--|--|----------------------|
|  | 86→03 | Proiettore ASY (R2) predisposto elettrico con trasparente arancio <i>Headlamp ASY (R2) fitted for electric with orange lens</i> | ➔ 8.10.002.00 |
| | | Proiettore ASY (R2) predisposto elettrico con trasparente arancio <i>Headlamp ASY (R2) fitted for electric with orange lens</i> | ➜ 8.10.003.00 |
| | * Ricambio di qualità equivalente Parts of matching quality | | |

| FIAT | | PANDA 750 | |
|---|--|---|----------------------|
|  | 95→98 | Proiettore ASY (R2) manuale con trasparente incolore <i>Manual headlamp ASY (R2) with clear lens</i> | ➔ 8.10.004.00 |
| | | Proiettore ASY (R2) manuale con trasparente incolore <i>Manual headlamp ASY (R2) with clear lens</i> | ➜ 8.10.005.00 |
| | * Ricambio di qualità equivalente Parts of matching quality | | |



| FIAT | | PANDA 750 | |
|---|--|--|----------------------|
|  | 95→98 | Proiettore ASY (R2) predisposto elettrico con trasparente incolore <i>Headlamp ASY (R2) fitted for electric with clear lens</i> | ➔ 8.10.006.00 |
| | | Proiettore ASY (R2) predisposto elettrico con trasparente incolore <i>Headlamp ASY (R2) fitted for electric with clear lens</i> | ➜ 8.10.007.00 |
| | * Ricambio di qualità equivalente Parts of matching quality | | |



| FIAT | | PANDA | |
|---|--|--|----------------------|
|  | 03→09 | Proiettore H4 con motorino 14 Pin <i>Headlamp H4 with device 14 Pin</i> | ➔ 8.10.028.00 |
| | | Proiettore H4 con motorino 14 Pin <i>Headlamp H4 with device 14 Pin</i> | ➜ 8.10.029.00 |
| | * Ricambio di qualità equivalente Parts of matching quality | | |







| FIAT | | PANDA | |
|---|--|--|----------------------|
|  | 09→12 | Proiettore H4 con motorino 8 Pin <i>Headlamp H4 with device 8 Pin</i> | ➔ 8.10.030.00 |
| | | Proiettore H4 con motorino 8 Pin <i>Headlamp H4 with device 8 Pin</i> | ➜ 8.10.031.00 |
| | * Ricambio di qualità equivalente Parts of matching quality | | |







| FIAT | | PUNTO EVO | |
|---|--|--|----------------------|
|  | 09→ | Proiettore (H4) con motorino DRL <i>Headlamp (H4) with small device DRL</i> | ➔ 8.00.068.00 |
| | | Proiettore (H4) con motorino DRL <i>Headlamp (H4) with small device DRL</i> | ➜ 8.00.069.00 |
| | * Ricambio di qualità equivalente Parts of matching quality | | |

| FIAT | | UNO | |
|---|--|--|----------------------|
|  | 89→93 | Proiettore H4 manuale <i>Manual headlamp H4</i> | ➔ 8.10.014.00 |
| | | Proiettore H4 manuale <i>Manual headlamp H4</i> | ➜ 8.10.015.00 |
| | * Ricambio di qualità equivalente Parts of matching quality | | |

| FORD | | MONDEO IV | |
|---|---|--|---------------------|
|  | 07→ | Proiettore (H7+H1) con motorino <i>Headlamp (H7+H1) with small device</i> | ➔ 2020001069 |
| | | Proiettore (H7+H1) con motorino <i>Headlamp (H7+H1) with small device</i> | ➜ 2020101069 |
| |  | | |

| FORD | | MONDEO IV | | XENON | |
|---|---|--|---------------------|-------|---|
|  | 07→ | Proiettore (D1S+H1) con motorino <i>Headlamp (D1S+H1) with small device</i> | ➔ 2020001067 | | |
| | | Proiettore (D1S+H1) con motorino <i>Headlamp (D1S+H1) with small device</i> | ➜ 2020101067 | | |
| | Con luce di curva dinamica <i>With dynamic turn light</i> 4/5 porte <i>4/5 doors</i> | | | |  |

| SKODA | | OCTAVIA 2 CLASSIC | |
|---|--|--|---|
|  | 04→ | Proiettore (H1+H7) con motorino <i>Headlamp (H1+H7) with small device</i> | ➔ 2020001040 |
| | | Proiettore (H1+H7) con motorino <i>Headlamp (H1+H7) with small device</i> | ➜ 2020101040 |
| | Completo di lampade <i>Bulb included</i> | |  |
| RENAULT | | CLIO IV | |
|  | 12→ | Proiettore elettrico con cornice cromata <i>Electric headlamp with chrome frame</i> | ➔ 8.10.112.00 |
| | | Proiettore elettrico con cornice cromata <i>Electric headlamp with chrome frame</i> | ➜ 8.10.113.00 |
| | * Ricambio di qualità equivalente <i>Parts of matching quality</i> | | |
| RENAULT | | CLIO IV | |
|  | 12→ | Proiettore elettrico con cornice nera <i>Electric headlamp with black frame</i> | ➔ 8.10.114.00 |
| | | Proiettore elettrico con cornice nera <i>Electric headlamp with black frame</i> | ➜ 8.10.115.00 |
| | * Ricambio di qualità equivalente <i>Parts of matching quality</i> | | |
| RENAULT | | CLIO IV | |
|  | 16→20 | Proiettore elettrico con cornice bianca <i>Electric headlamp with white frame</i> | ➔ 8.10.116.00 |
| | | Proiettore elettrico con cornice bianca <i>Electric headlamp with white frame</i> | ➜ 8.10.117.00 |
| | * Ricambio di qualità equivalente <i>Parts of matching quality</i> | | |
| TOYOTA | | YARIS | |
|  | 06→09 | Proiettore (H4) con motorino <i>Headlamp (H4) with small device</i> | ➔ 8.00.072.00 |
| | | Proiettore (H4) con motorino <i>Headlamp (H4) with small device</i> | ➜ 8.00.073.00 |
| | | | |

| | | | | | |
|---|-----|---|--------|--------------------|--|
| ALFA ROMEO | | 159 | | | |
|  | 06→ | Fendinebbia (H1) <i>Fog lamp (H1)</i> | → ← | 8.20.050.00 | |
| | | Staffa nera <i>Black bracket</i> | | | |
| ALFA ROMEO | | GIULIETTA | | | |
|  | 10→ | Fendinebbia (H1) <i>Fog lamp (H1)</i> | → ← | 8.20.074.00 | |
| | | | | | |
| FIAT | | 500 ABARTH | | | |
|  | 09→ | Proiettore Fendinebbia (H1) <i>Fog lamp (H1)</i> | → | 8.20.098.00 | |
| | | Proiettore Fendinebbia (H1) <i>Fog lamp (H1)</i> | ← | 8.20.099.00 | |
| | | | | | |
| FIAT | | NUOVA 500L PANDA | | | |
|  | 12→ | Proiettore Fendinebbia (H1) <i>Fog lamp (H1)</i> | → ← | 8.20.094.00 | |
| | | Portalampada (H1) <i>Bulb holder (H1)</i> | | 3.49.092.00 | |
| FIAT | | CROMA DUCATO PANDA | | | |
|  | 06→ | Fendinebbia (H1) <i>Fog lamp (H1)</i> | → ← | 8.20.070.00 | |
| | | | | | |
| FIAT | | FIORINO NEMO QUBO BIPPER | | | |
|  | 08→ | Proiettore fendinebbia (H1) <i>Fog lamp (H1)</i> | → | 8.20.066.00 | |
| | | Proiettore fendinebbia (H1) <i>Fog lamp (H1)</i> | ← | 8.20.067.00 | |
| | | | | | |

| FIAT | | PANDA CROSS | | |
|---|-----|--|---|--------------------|
|  | 13→ | Fendinebbia (H1) <i>Fog lamp (H1)</i> | ↔ | 8.20.068.00 |
| | | Portalampada (H1) <i>Bulb holder (H1)</i> | | 3.49.092.00 |

| FIAT | | PUNTO EVO | | |
|---|-----|--|---|--------------------|
|  | 08→ | Fendinebbia (H11) <i>Fog lamp (H11)</i> | ↔ | 8.20.082.00 |
| | | | | |

| FORD | | KA | | |
|---|-----|--|---|--------------------|
|  | 08→ | Fendinebbia (H1) <i>Fog lamp (H1)</i> | ↔ | 8.20.072.00 |
| | | Fendinebbia (H1) <i>Fog lamp (H1)</i> | ↔ | 8.20.073.00 |
| | | | | |

| LANCIA | | YPSILON | | |
|---|-----|--|---|--------------------|
|  | 12→ | Fendinebbia (H1) <i>Fog lamp (H1)</i> | ↔ | 8.20.096.00 |
| | | Fendinebbia (H1) <i>Fog lamp (H1)</i> | ↔ | 8.20.097.00 |
| | | | | |

| RENAULT CITROËN DACIA FORD PEUGEOT | | | | |
|---|-----|--|---|--------------------|
|  | 12→ | Fendinebbia (H11) <i>Fog lamp (H11)</i> | ↔ | 8.50.070.00 |
| | | | | |

LAMPS FOR INDUSTRIAL VEHICLES
FANALI PER VEICOLI INDUSTRIALI

| DAF | | XF - CF - LF | |
|---|--|---|------------------------------|
|  | 08→ | Gruppo ottico anteriore <i>Front optical unit</i> | → ← 2.41.114.12 |
| | * Ricambio di qualità equivalente Matching quality spare parts | | |
| DAF | | XF | |
|  | 08→ | Gruppo ottico anteriore su pedana <i>Front optical unit on steps</i> | → ← 2.41.116.20 |
| | | Portalampade <i>Bulb holder</i> | 1.09.052.00 |
| | * Ricambio di qualità equivalente Matching quality spare parts | | |
| FIAT | | 619 - 684 - 697 | |
|  | | Trasparente anteriore <i>Front lens</i> | → 2.41.110.27 |
| | | Trasparente anteriore <i>Front lens</i> | ← 2.41.111.27 |
| | * Ricambio di qualità equivalente Matching quality spare parts | | |
| FIAT OM | | 110 130 170 | |
|  | | Trasparente anteriore <i>Front lens</i> | → 2.41.102.27 |
| | | Trasparente anteriore <i>Front lens</i> | ← 2.41.103.27 |
| | * Ricambio di qualità equivalente Matching quality spare parts | | |
| FIAT OM | | 50 55 65 75 80 | |
|  | 75→ | Trasparente anteriore <i>Front lens</i> | → 2.41.104.27 |
| | | Trasparente anteriore <i>Front lens</i> | ← 2.41.105.27 |
| | * Ricambio di qualità equivalente Matching quality spare parts | | |

| FIAT | | DUCATO | |
|---|---|--|----------------------|
|  | 94→02 | Gruppo ottico anteriore <i>Front optical unit</i> | ➔ 2.41.108.12 |
| | | Gruppo ottico anteriore <i>Front optical unit</i> | ➔ 2.41.109.12 |
| | * Ricambio di qualità equivalente Matching quality spare parts | | |

| FIAT / CITROËN | | SCUDO | |
|---|---|---------------------------------------|----------------------|
|  | 95→04 | Fanale anteriore <i>Front lamp</i> | ➔ 5.41.068.00 |
| | | Fanale anteriore <i>Front lamp</i> | ➔ 5.41.069.00 |
| | * Ricambio di qualità equivalente Matching quality spare parts | | |

| IVECO | | DAILY | |
|---|-------|--|----------------------|
|  | 90→00 | Fanale anteriore <i>Front lamp</i> | ➔ 2.41.048.00 |
| | | | ➔ 2.41.049.00 |
| | 90→00 | Trasparente anteriore <i>Front lens</i> | ➔ 2.41.048.25 |
| | | | ➔ 2.41.049.25 |
| * Ricambio di qualità equivalente Matching quality spare parts | | | |

| IVECO | | DAILY (S2000) | |
|---|---|--|----------------------|
|  | 99→04 | Fanale anteriore arancio <i>Orange front lamp</i> | ➔ 5.41.072.00 |
| | | Fanale anteriore arancio <i>Orange front lamp</i> | ➔ 5.41.073.00 |
| | * Ricambio di qualità equivalente Matching quality spare parts | | |

| IVECO | | DAILY (S2000) | |
|---|---|--|----------------------|
|  | 02→07 | Fanale anteriore incolore <i>Clear front lamp</i> | ➔ 5.41.070.00 |
| | | Fanale anteriore incolore <i>Clear front lamp</i> | ➔ 5.41.071.00 |
| | * Ricambio di qualità equivalente Matching quality spare parts | | |

| IVECO | | DAILY 2014 | | |
|---|--|--|---|--------------------|
|  | 14→ | Fanale anteriore incolore <i>Clear front lamp</i> | → | 5.41.086.00 |
| | | Fanale anteriore incolore <i>Clear front lamp</i> | ← | 5.41.087.00 |
| | * Ricambio di qualità equivalente Matching quality spare parts | | | |

| IVECO | | EUROCARGO | | |
|---|--|---------------------------------------|---|--------------------|
|  | 91→02 | Fanale anteriore <i>Front lamp</i> | → | 2.41.100.00 |
| | | Fanale anteriore <i>Front lamp</i> | ← | 2.41.101.00 |
| | * Ricambio di qualità equivalente Matching quality spare parts | | | |

| IVECO | | EUROCARGO | | |
|---|-----|---------------------------------------|---|--------------------|
|  | 04→ | Fanale anteriore <i>Front lamp</i> | → | 2.41.054.00 |
| | | | ← | |
| * Ricambio di qualità equivalente Matching quality spare parts | | | | |

| IVECO | | EUROTECH EUROTRAKKER | | |
|---|--|---------------------------------------|---|--------------------|
|  | 93→02 | Fanale anteriore <i>Front lamp</i> | → | 5.41.054.00 |
| | | Fanale anteriore <i>Front lamp</i> | ← | 5.41.055.00 |
| | * Ricambio di qualità equivalente Matching quality spare parts | | | |

| IVECO | | EUROSTAR EUROTECH | | |
|---|--|---------------------------------------|---|--------------------|
|  | 91→02 | Fanale anteriore <i>Front lamp</i> | → | 5.41.050.00 |
| | | Fanale anteriore <i>Front lamp</i> | ← | 5.41.051.00 |
| | * Ricambio di qualità equivalente Matching quality spare parts | | | |

| IVECO | | SERIE Z | |
|---|---|--|----------------------|
|  | →86 | Trasparente anteriore <i>Front lens</i> | ➔ 2.41.058.27 |
| | | Trasparente anteriore <i>Front lens</i> | ➔ 2.41.059.27 |
| | * Ricambio di qualità equivalente Matching quality spare parts | | |

| IVECO | | SERIE Z | |
|---|---|---|----------------------|
|  | 87→ | Trasparente anteriore incolore <i>Front clear lens</i> | ➔ 2.41.126.25 |
| | | Trasparente anteriore incolore <i>Front clear lens</i> | ➔ 2.41.127.25 |
| | * Ricambio di qualità equivalente Matching quality spare parts | | |

| IVECO | | STRALIS | |
|---|---|---------------------------------------|----------------------|
|  | 02→07 | Fanale anteriore <i>Front lamp</i> | ➔ 2.41.066.00 |
| | | Fanale anteriore <i>Front lamp</i> | ➔ 2.41.067.00 |
| | * Ricambio di qualità equivalente Matching quality spare parts | | |

| IVECO | | STRALIS | |
|---|---|--|----------------------|
|  | 07→ | Fanale anteriore arancio <i>Orange front lamp</i> | ➔ 2.41.050.00 |
| | | Fanale anteriore arancio <i>Orange front lamp</i> | ➔ 2.41.051.00 |
| | * Ricambio di qualità equivalente Matching quality spare parts | | |

| IVECO | | STRALIS | |
|---|---|--|----------------------|
|  | 07→ | Fanale anteriore incolore <i>Clear front lamp</i> | ➔ 2.41.094.00 |
| | | Fanale anteriore incolore <i>Clear front lamp</i> | ➔ 2.41.095.00 |
| | * Ricambio di qualità equivalente Matching quality spare parts | | |

| IVECO | | STRALIS | | |
|---|-----|---|--|--------------------|
|  | 04→ | Fanale anteriore <i>Front lamp</i> |   | 2.41.054.00 |
| | | * Ricambio di qualità equivalente <i>Matching quality spare parts</i> | | |
| IVECO | | TURBO STAR | | |
|  | 85→ | Fanale anteriore <i>Front lamp</i> |   | 2.42.050.00 |
| | | * Ricambio di qualità equivalente <i>Matching quality spare parts</i> | | |
| IVECO | | 190 TURBO | | |
|  | 82→ | Fanale anteriore <i>Front lamp</i> |   | 1.41.052.00 |
| | | Fanale anteriore <i>Front lamp</i> |  | 1.41.053.00 |
| | | Trasparente <i>Lens</i> |   | 1.41.052.24 |
| | | Trasparente <i>Lens</i> |  | 1.41.053.24 |
| * Ricambio di qualità equivalente <i>Matching quality spare parts</i> | | | | |
| MAN | | F 2000 | | |
|  | 94→ | Fanale anteriore <i>Front lamp</i> |   | 2.41.062.00 |
| | | * Ricambio di qualità equivalente <i>Matching quality spare parts</i> | | |
| MAN | | TGA TGX TGL | | |
|  | | Fanale anteriore arancio <i>Orange front lamp</i> |   | 2.41.070.00 |
| | | Fanale anteriore incolore <i>Clear front lamp</i> |   | 2.41.072.00 |
| | | * Ricambio di qualità equivalente <i>Matching quality spare parts</i> | | |

| MERCEDES | | ACTROS | | | |
|---|-------|---|---|--------------------|--|
|  | | Fanale anteriore <i>Front lamp</i> | ↔ | 2.41.074.00 | |
| | | * Ricambio di qualità equivalente <i>Matching quality spare parts</i> | | | |
| MERCEDES | | ACTROS MP4 | | LED | |
|  | 08→11 | Fanale anteriore posizione <i>Front lamp</i> | ↔ | 2.41.332.80 | |
| | | * Ricambio di qualità equivalente <i>Matching quality spare parts</i> | | | |
| MERCEDES | | ACTROS AXOR | | | |
|  | 98→ | Fanale anteriore <i>Front lamp</i> | ↔ | 2.41.080.00 | |
| | | * Ricambio di qualità equivalente <i>Matching quality spare parts</i> | | | |
| MERCEDES | | AXOR | | | |
|  | 04→ | Fanale anteriore <i>Front lamp</i> | ↔ | 2.41.064.00 | |
| | | Fanale anteriore <i>Front lamp</i> | ↔ | 2.41.065.00 | |
| | | * Ricambio di qualità equivalente <i>Matching quality spare parts</i> | | | |
| MERCEDES | | ATEGO | | LED | |
|  | 13→ | Fanale anteriore DRL led - con direzione <i>Front lamp led DRL with direction</i> | ↔ | 2.41.132.80 | |
| | | Fanale anteriore DRL led - con direzione <i>Front lamp led DRL with direction</i> | ↔ | 2.41.133.80 | |
| | | PY21W * Ricambio di qualità equivalente <i>Matching quality spare parts</i> | | | |

| MERCEDES | | ATEGO | | |
|---|-----|--|---|--------------------|
|  | 13→ | Fanale anteriore con luce diurna con direzione led <i>Front lamp led DRL with direction</i> | ➔ | 2.41.132.00 |
| | | Fanale anteriore con luce diurna con direzione led <i>Front lamp led DRL with direction</i> | ➔ | 2.41.133.00 |
| | | PY21W - P21W * Ricambio di qualità equivalente <i>Matching quality spare parts</i> | | |

| MERCEDES | | ATEGO | | |
|---|-------|---|---|--------------------|
|  | 98→04 | Indicatore di direzione arancio <i>Orange front lamp</i> | ➔ | 2.41.330.00 |
| | | Indicatore di direzione arancio <i>Orange front lamp</i> | ➔ | 2.41.331.00 |
| | | * Ricambio di qualità equivalente <i>Matching quality spare parts</i> | | |

| MERCEDES | | ATEGO II | | |
|---|-----|---|---|--------------------|
|  | 04→ | Fanale anteriore <i>Front lamp</i> | ➔ | 2.41.088.00 |
| | | Fanale anteriore <i>Front lamp</i> | ➔ | 2.41.089.00 |
| | | * Ricambio di qualità equivalente <i>Matching quality spare parts</i> | | |

| MERCEDES | | SPRINTER T1 - TN | | |
|---|-------|---|---|--------------------|
|  | 95→00 | Fanale anteriore incolore <i>Clear front lamp</i> | ➔ | 2.41.096.00 |
| | | Fanale anteriore incolore <i>Clear front lamp</i> | ➔ | 2.41.097.00 |
| | | * Ricambio di qualità equivalente <i>Matching quality spare parts</i> | | |

| NISSAN | | CABSTAR | | |
|---|-------|---|---|--------------------|
|  | 98→02 | Gruppo ottico anteriore <i>Front optical unit</i> | ➔ | 2.41.068.10 |
| | | Gruppo ottico anteriore <i>Front optical unit</i> | ➔ | 2.41.069.10 |
| | | * Ricambio di qualità equivalente <i>Matching quality spare parts</i> | | |

| RENAULT | | MASTER | | |
|---|-----|---|---|--------------------|
|  | 99→ | Fanale anteriore <i>Front lamp</i> | → | 5.41.062.00 |
| | | Fanale anteriore <i>Front lamp</i> | ← | 5.41.063.00 |
| | | * Ricambio di qualità equivalente <i>Matching quality spare parts</i> | | |

| RENAULT | | MAGNUM | | |
|---|-------|---|--|--------------------|
|  | 99→06 | Indicatore di direzione arancio <i>Orange front lamp</i> | | 2.41.333.00 |
| | | * Ricambio di qualità equivalente <i>Matching quality spare parts</i> | | |

| RENAULT | | MAGNUM | | |
|---|-------|---|--|--------------------|
|  | 99→06 | Indicatore di direzione incolore <i>Clear front lamp</i> | | 2.41.334.00 |
| | | * Ricambio di qualità equivalente <i>Matching quality spare parts</i> | | |

| RENAULT | | PREMIUM MIDLUM KERAX | | |
|---|-----|---|---|--------------------|
|  | 99→ | Fanale anteriore <i>Front lamp</i> | → | 2.41.060.00 |
| | | Fanale anteriore <i>Front lamp</i> | ← | 2.41.061.00 |
| | | * Ricambio di qualità equivalente <i>Matching quality spare parts</i> | | |

| RENAULT | | RANGE T | | LED |
|---|-----|---|---|--------------------|
|  | 15→ | Indicatore di direzione <i>Front lamp</i> | → | 2.41.130.80 |
| | | Indicatore di direzione <i>Front lamp</i> | ← | 2.41.131.80 |
| | | * Ricambio di qualità equivalente <i>Matching quality spare parts</i> | | |



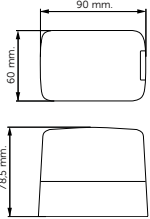

| SCANIA | | SERIE 94-114-124-144-R | | LED |
|--|-------|--|--|--|
|  | 98→ | Fanale anteriore arancio con cavo <i>Orange front lamp with cable</i> |   | 2.42.080.80 |
| | | 24V | | |
| | | * Ricambio di qualità equivalente Matching quality spare parts | | |
| SCANIA | | SERIE 4 114-124 | | |
|   | 95→ | Gruppo ottico anteriore <i>Front optical unit</i> |   | 2.41.086.27 2.41.087.27 |
| | | Cablaggio <i>Wiring</i> |  | 2.41.086.19 |
| | | * Ricambio di qualità equivalente Matching quality spare parts | | |
| SCANIA | | SERIE P-R-G | | LED |
|  | 14→ | Fanale anteriore <i>Front lamp</i> |   | 2.41.329.80 |
| | | * Ricambio di qualità equivalente Matching quality spare parts | | |
| SCANIA | | SERIE P-R-G | | LED |
|  | 14→ | Fanale anteriore <i>Front lamp</i> |   | 2.41.328.80 |
| | | * Ricambio di qualità equivalente Matching quality spare parts | | |
| SCANIA | | SERIE R-P | | LED |
|  | 07→09 | Fanale anteriore <i>Front lamp</i> |   | 2.41.092.00 |
| | | 4 led 24V | | |
| | | * Ricambio di qualità equivalente Matching quality spare parts | | |





| SCANIA | | SERIE R-P | | LED |
|---|-------|---|--|--------------------|
|  | 09→14 | Fanale anteriore arancio con DRL Lampade 21W + 4 led + 8 led DRL |   | 2.41.098.80 |
| | | <i>Orange front lamp with DRL 21W bulb + 4 led + 8 led DRL</i> | | |
| * Ricambio di qualità equivalente Matching quality spare parts | | | | |
| VOLVO | | FH-FM | | |
|  | 93→01 | Fanale anteriore incolore Clear front lamp |   | 2.41.118.00 |
| | | | | |
| * Ricambio di qualità equivalente Matching quality spare parts | | | | |
| VOLVO | | FH12 FL FM | | |
|  | 98→05 | Fanale anteriore Front lamp |   | 2.41.082.00 |
| | | | | |
| * Ricambio di qualità equivalente Matching quality spare parts | | | | |
| VOLVO | | BUS | | |
|  | 98→05 | Fanale anteriore arancio Orange front lamp |   | 2.41.084.00 |
| | | | | |
| * Ricambio di qualità equivalente Matching quality spare parts | | | | |
| UNIVERSALE | | TRATTORI TRACTORS | | |
|  | | Fanale anteriore Front lamp |  | 2.41.056.00 |
| | | | | |
| * Ricambio di qualità equivalente Matching quality spare parts | | | | |

| UNIVERSALE | | TRATTORI TRACTORS | |
|---|---|--|--------------------|
|  | Fanale anteriore con base alta <i>Front lamp with high base</i> |  | 2.41.058.00 |
| | * Ricambio di qualità equivalente <i>Matching quality spare parts</i> | | |

| UNIVERSALE | | LED | |
|---|--|--|--------------------|
|  | Fanale anteriore direzione <i>Repeater front lamp</i> |  | 2.41.078.80 |
| | 9-33V | * Ricambio di qualità equivalente <i>Matching quality spare parts</i> | |

| UNIVERSALE | | TRATTORI TRACTORS | |
|---|---|---------------------|--------------------|
|  | Fanale anteriore <i>Front lamp</i> | | 2.41.106.00 |
| | Trasparente <i>Lens</i> | | 2.41.106.27 |
| | * Ricambio di qualità equivalente <i>Matching quality spare parts</i> | | |

| UNIVERSALE | | | |
|---|---|--|--------------------|
|  | Fanale anteriore <i>Front lamp</i> |   | 2.41.112.00 |
| | Trasparente anteriore <i>Front lens</i> |   | 2.41.112.27 |
| | * Ricambio di qualità equivalente <i>Matching quality spare parts</i> | | |

| UNIVERSALE | | | |
|---|---|--|--------------------|
|  | Fanale anteriore <i>Front lamp</i> |   | 2.41.113.00 |
| | Trasparente anteriore <i>Front lens</i> |   | 2.41.113.27 |
| | * Ricambio di qualità equivalente <i>Matching quality spare parts</i> | | |

UNIVERSALE



Fanale direzione anteriore arancio
Front repeater orange lamp

2.41.076.00

* **Ricambio di qualità equivalente | Matching quality spare parts**

UNIVERSALE

LED



Fanale anteriore flashing arancio
Flashing orange front lamp



2.47.088.80

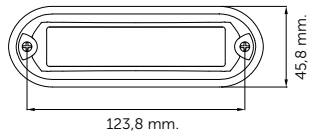

Fanale anteriore flashing incolore
Flashing clear front lamp



2.47.090.80

6 led | 9-33V

Dimensioni / *Dimension* 144,8x26,9 mm.

| DAF | | 75 85 XF CF | | |
|---|-------|--|--|--------------------|
|  | 99→04 | Fanale laterale incolore <i>Clear side lamp</i> |   | 5.43.056.00 |
| | | Fanale laterale incolore <i>Clear side lamp</i> |   | 2.42.078.00 |
| | | Portalampada <i>Bulb holder</i> | | 2.42.076.18 |
| | |  | | |
| DAF | | CF85 XF95 | | |
|  | 02→08 | Fanale laterale <i>Side lamp</i> |   | 2.42.134.00 |
| | | * Ricambio di qualità equivalente <i>Matching quality spare parts</i> | | |
| DAF | | XF 106 | | |
|  | 13→ | Fanale laterale incolore <i>Clear side lamp</i> |  | 2.42.144.00 |
| | | Fanale laterale incolore <i>Clear side lamp</i> |  | 2.42.145.00 |
| | | * Ricambio di qualità equivalente <i>Matching quality spare parts</i> | | |
| FIAT | | 690 | | |
|  | | Fanale laterale <i>Side lamp</i> |   | 2.42.066.00 |
| | | Trasparente <i>Lens</i> |   | 2.42.066.24 |
| | | Corpo nero / <i>Black body</i> | | |
| | | * Ricambio di qualità equivalente <i>Matching quality spare parts</i> | | |

| FIAT | | 690 | | |
|---|-------|---|--|--------------------|
|  | | Fanale laterale <i>Side lamp</i> |   | 2.42.070.00 |
| | | Trasparente <i>Lens</i> |   | 2.42.066.24 |
| | | Corpo cromato <i>Chrome body</i> | | |
| | | * Ricambio di qualità equivalente <i>Matching quality spare parts</i> | | |
| FIAT | | DUCATO | | |
|  | →90 | Fanale laterale <i>Side lamp</i> |   | 1.42.050.00 |
| | | * Ricambio di qualità equivalente <i>Matching quality spare parts</i> | | |
| FIAT | | DUCATO | | |
|  | 89→94 | Fanale laterale <i>Side lamp</i> |   | 1.42.052.00 |
| | | * Ricambio di qualità equivalente <i>Matching quality spare parts</i> | | |
| FIAT | | DUCATO | | |
|  | 94→00 | Fanale laterale <i>Side lamp</i> |   | 1.42.054.00 |
| | | * Ricambio di qualità equivalente <i>Matching quality spare parts</i> | | |
| FIAT | | DUCATO | | |
|  | 02→ | Gruppo ottico laterale <i>Side optical unit</i> |   | 1.42.058.11 |
| | | * Ricambio di qualità equivalente <i>Matching quality spare parts</i> | | |

| FIAT | | DUCATO | | |
|---|-----|--|---|--------------------|
|  | 06→ | Gruppo ottico laterale su specchio retrovisore <i>Side optical unit on rear view mirror</i> | → | 5.42.056.12 |
| | | Gruppo ottico laterale su specchio retrovisore <i>Side optical unit on rear view mirror</i> | ← | 5.42.057.12 |
| | | | | |

| FIAT | | DUCATO | | |
|---|-----|--|---|--------------------|
|  | 06→ | Gruppo ottico laterale su specchio retrovisore <i>Side optical unit on rear view mirror</i> | → | 5.42.058.12 |
| | | Gruppo ottico laterale su specchio retrovisore <i>Side optical unit on rear view mirror</i> | ← | 5.42.059.12 |
| | | | | |

| FORD | | TRANSIT MK VII | | |
|---|-----|-------------------------------------|--------------------------------------|--------------------|
|  | 06→ | Fanale laterale <i>Side lamp</i> | → | 5.42.054.00 |
| | | Fanale laterale <i>Side lamp</i> | ← | 5.42.055.00 |
| | | | Distanziale mm. 640 Spacer mm. 640 | |

| IVECO | | BUS | | |
|---|--|---|--|--------------------|
|  | | Fanale laterale ingombro W5W <i>W5W Side lamp drive marker</i> | | 2.43.048.00 |
| | | Portalampane <i>Bulb holder</i> | | 2.43.048.18 |
| | | * Ricambio di qualità equivalente Matching quality spare parts | | |

| IVECO | | DAILY OM | | |
|---|-----|-------------------------------------|--------|--------------------|
|  | →96 | Fanale laterale <i>Side lamp</i> | → ← | 1.42.060.00 |
| | | | | |

| IVECO | | DAILY S.2000 | |
|---|-------|--|----------------------|
|  | 99→04 | Fanale laterale arancio <i>Orange side lamp</i> | ➔ 1.42.062.00 |
| | | Fanale laterale arancio <i>Orange side lamp</i> | ➔ 1.42.063.00 |
| | | | |

| IVECO | | DAILY S.2000 | |
|---|-------|--|----------------------|
|  | 99→04 | Fanale laterale arancio <i>Orange side lamp</i> | ➔ 1.42.066.00 |
| | | Fanale laterale arancio <i>Orange side lamp</i> | ➔ 1.42.067.00 |
| | | | |

| IVECO | | DAILY S.2000 | |
|---|-----|--|----------------------|
|  | 04→ | Fanale laterale incolore <i>Clear side lamp</i> | ➔ 1.42.064.00 |
| | | Fanale laterale incolore <i>Clear side lamp</i> | ➔ 1.42.065.00 |
| | | | |

| IVECO | | DAILY S.2000 | |
|---|-----|--|----------------------|
|  | 04→ | Fanale laterale incolore <i>Clear side lamp</i> | ➔ 1.42.068.00 |
| | | Fanale laterale incolore <i>Clear side lamp</i> | ➔ 1.42.069.00 |
| | | | |

| IVECO | | DAILY | |
|---|-------|--|---|
|  | 06→12 | Gruppo ottico laterale su specchio retrovisore <i>Side optical unit on rear view mirror</i> | ➔ 2.42.060.12 |
| | | Gruppo ottico laterale su specchio retrovisore <i>Side optical unit on rear view mirror</i> | ➔ 2.42.061.12 |
| | | | * Ricambio di qualità equivalente Matching quality spare parts |





| IVECO | | DAILY 2014 | | |
|---|---|---|---|--------------------|
|  | 12→19 | Gruppo ottico laterale su specchietto <i>Side optical unit on mirror</i> | → | 2.42.068.12 |
| | | Gruppo ottico laterale su specchietto <i>Side optical unit on mirror</i> | ← | 2.42.069.12 |
| | * Ricambio di qualità equivalente <i>Matching quality spare parts</i> | | | |



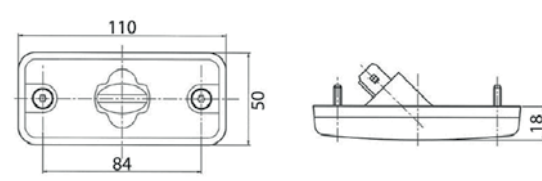

| IVECO | | DAILY | | |
|---|---|---|---|--------------------|
|  | 19→ | Gruppo ottico laterale fumè su specchietto <i>Fumè side optical unit on mirror</i> | → | 2.42.068.15 |
| | | Gruppo ottico laterale fumè su specchietto <i>Fumè side optical unit on mirror</i> | ← | 2.42.069.15 |
| | * Ricambio di qualità equivalente <i>Matching quality spare parts</i> | | | |

| IVECO | | EUROCARGO | | |
|---|-----|--|---|--------------------|
|  | →04 | Gruppo ottico laterale <i>Side optical unit</i> | → | 1.42.070.10 |
| | | ← | | |

| IVECO | | EUROCARGO | | |
|---|-----|-------------------------------------|---|--------------------|
|  | →04 | Fanale laterale <i>Side lamp</i> | → | 1.42.072.00 |
| | | ← | | |

| iveco | | EUROCARGO | | |
|---|-----|---------------------------------------|---|--------------------|
|  | 04→ | Fanale anteriore <i>Front lamp</i> | → | 2.42.104.00 |
| | | ← | | |
| * Ricambio di qualità equivalente <i>Matching quality spare parts</i> | | | | |

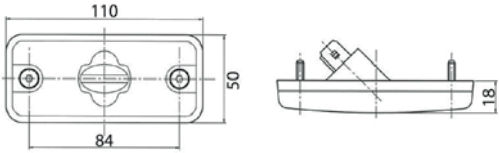
| IVECO | | EUROCARGO | | |
|---|-------|--|--------|--------------------|
|  | 04→12 | Fanale anteriore <i>Front lamp</i> | → ← | 2.42.106.00 |
| | | * Ricambio di qualità equivalente <i>Matching quality spare parts</i> | | |
| IVECO | | EUROTECH | | |
|  | | Trasparente laterale <i>Side lens</i> | → | 1.42.074.24 |
| | | Trasparente laterale <i>Side lens</i> | ← | 1.42.075.24 |
| | | | | |
| IVECO | | EUROTECH EUROSTAR STRALIS | | |
|  | 99→04 | Fanale laterale arancio <i>Orange side lamp</i> | → ← | 5.42.050.00 |
| | | Fanale laterale arancio <i>Orange side lamp</i> | → ← | 2.42.076.00 |
| | | Portalampada <i>Bulb holder</i> | | 2.42.076.18 |
| | |  | | |
| IVECO | | EUROTECH | | |
|  | 93→ | Fanale laterale <i>Side lamp</i> | → ← | 1.42.076.00 |
| | | | | |

| IVECO | | EUROTECH | |
|---|--|--|--|
|  | | Gruppo ottico laterale <i>Side optical unit</i> | <p>➔ 1.42.076.11</p> <p>➜ 1.42.077.11</p> |
| | <p>* Ricambio di qualità equivalente Matching quality spare parts</p> | | |
| IVECO | | SERIE Z | |
|  | | Fanale laterale <i>Side lamp</i> | ➔ 2.42.074.00 |
| | | Fanale laterale <i>Side lamp</i> | ➜ 2.42.075.00 |
| <p>* Ricambio di qualità equivalente Matching quality spare parts</p> | | | |
| IVECO | | STRALIS EUROSTAR IRISBUS | |
|  | | Fanale laterale <i>Side lamp</i> | <p>➔ 5.42.070.00</p> <p>➜</p> |
| | | Fanale laterale <i>Side lamp</i> | <p>➔ 2.42.076.00</p> <p>➜</p> |
| | 00→ | Portalampada <i>Bulb holder</i> | 2.42.078.18 |
| | <p>Con attacco superseal <i>With superseal connection</i></p> | |  |
| IVECO | | STRALIS | |
|  | | Fanale laterale arancio <i>Orange side lamp</i> | ➔ 2.42.080.00 |
| | 03→ | Fanale laterale arancio <i>Orange side lamp</i> | ➜ 2.42.081.00 |
| | <p>3 fori corpo grigio / <i>3 holes grey body</i></p> | | <p>* Ricambio di qualità equivalente Matching quality spare parts</p> |

| IVECO | | STRALIS | | |
|---|---|--|---|--------------------|
|  | 03→ | Fanale laterale arancio <i>Orange side lamp</i> | → | 2.42.084.00 |
| | | Fanale laterale arancio <i>Orange side lamp</i> | ← | 2.42.085.00 |
| | 3 fori corpo nero / 3 holes black body | | | |
| | * Ricambio di qualità equivalente Matching quality spare parts | | | |



| IVECO | | STRALIS | | |
|---|---|--|---|--------------------|
|  | 03→ | Fanale laterale arancio <i>Orange side lamp</i> | → | 2.42.090.00 |
| | | Fanale laterale arancio <i>Orange side lamp</i> | ← | 2.42.091.00 |
| | 2 fori corpo nero / 2 holes black body | | | |
| | * Ricambio di qualità equivalente Matching quality spare parts | | | |

| IVECO | | STRALIS | | |
|---|---|--|---|--------------------|
|  | 03→ | Fanale laterale incolore <i>Clear side lamp</i> | → | 2.42.086.00 |
| | | Fanale laterale incolore <i>Clear side lamp</i> | ← | 2.42.087.00 |
| | 3 fori corpo nero / 3 holes black body | | | |
| | * Ricambio di qualità equivalente Matching quality spare parts | | | |

| IVECO | | STRALIS | | |
|---|---|--|---|--------------------|
|  | 03→ | Fanale laterale incolore <i>Clear side lamp</i> | → | 2.42.088.00 |
| | | Fanale laterale incolore <i>Clear side lamp</i> | ← | 2.42.089.00 |
| | 3 fori corpo grigio / 3 holes grey body | | | |
| | * Ricambio di qualità equivalente Matching quality spare parts | | | |

| IVECO | | EUROCARGO - STRALIS | |
|---|---|---|----------------------|
|  | 12→ | Fanale anteriore incolore <i>Clear side lamp</i> | → 2.42.072.00 |
| | | Fanale anteriore incolore <i>Clear side lamp</i> | ← 2.42.073.00 |
| | Corpo nero 2 fori / <i>2 holes black body</i> | | |
| | * Ricambio di qualità equivalente <i>Matching quality spare parts</i> | | |



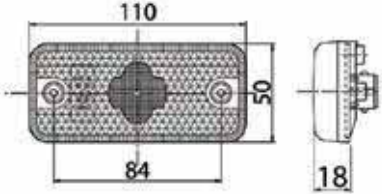

| IVECO | | VARIUS | |
|---|---|-------------------------------------|---------------------------|
|  | | Fanale laterale <i>Side lamp</i> | → ← 2.42.102.00 |
| | | Trasparente <i>Lens</i> | → ← 2.42.102.24 |
| | * Ricambio di qualità equivalente <i>Matching quality spare parts</i> | | |



| IVECO | | LED | |
|---|--|---|---|
|  | | Fanale laterale <i>Side lamp</i> | → ← 5.42.082.80 |
| | | 4 led 24V | |
| | | Con attacco superseal <i>With superseal connection</i> |  |
| | |  | |

| MAN | | TGA TGL TGS | |
|---|---|-------------------------------------|---------------------------|
|  | 98→ | Fanale laterale <i>Side lamp</i> | → ← 2.42.136.00 |
| | * Ricambio di qualità equivalente <i>Matching quality spare parts</i> | | |

| MAN | TGA TGM TGL L2000 | LED |
|---|---|--|
|  | 04→ Fanale anteriore incolore con cavo <i>Clear front lamp with cable</i> |   2.42.082.80 |
| | 24V | |
| | * Ricambio di qualità equivalente Matching quality spare parts | |
| MAN | TGL | |
|  | 14→ Fanale laterale arancio <i>Orange side lamp</i> |   2.42.142.00 |
| | * Ricambio di qualità equivalente Matching quality spare parts | |
| | | |
| MERCEDES | ACTROS | LED |
|  | Fanale laterale <i>Side lamp</i> |   4.42.056.80 |
| | 24V | |
| |   | |
| MERCEDES | ACTROS | LED |
|  | 00→ Fanale laterale <i>Side lamp</i> |   2.42.058.80 |
| | 24V | |
| | * Ricambio di qualità equivalente Matching quality spare parts | |
| MERCEDES | ACTROS | |
|  | 13→ Fanale laterale <i>Side lamp</i> |  2.42.094.00 |
| | 13→ Fanale laterale <i>Side lamp</i> |  2.42.095.00 |
| | * Ricambio di qualità equivalente Matching quality spare parts | |

| MERCEDES | | ACTROS MP1 AXOR 2 | | |
|--|---|--|--|--------------------|
|  | 96→02 | Fanale laterale arancio <i>Orange side lamp</i> |   | 2.42.135.00 |
| | | * Ricambio di qualità equivalente <i>Matching quality spare parts</i> | | |
| MERCEDES | | ATEGO I-II | | |
|  | 98→ | Fanale direzione anteriore arancio <i>Orange front repeater lamp</i> |  | 2.42.096.00 |
| | | Fanale direzione anteriore arancio <i>Orange front repeater lamp</i> |  | 2.42.097.00 |
| | * Ricambio di qualità equivalente <i>Matching quality spare parts</i> | | | |
| MERCEDES | | AXOR ACTROS | | |
|  | 02→ | Gruppo ottico laterale <i>Side optical unit</i> |   | 2.42.056.11 |
| | | * Ricambio di qualità equivalente <i>Matching quality spare parts</i> | | |
| MERCEDES | | SPRINTER II CRAFTER | | |
|   | 05→06 | Fanale laterale su retrovisore 1990-2100-2300 <i>Side lamp on rear view mirror 1990-2100-2300</i> |  | 5.42.062.00 |
| | | Fanale laterale su retrovisore 1990 <i>Side lamp on rear view mirror 1990</i> |  | 5.42.063.00 |
| | | Fanale laterale su retrovisore 2100-2300 <i>Side lamp on rear view mirror 2100-2300</i> |  | 5.42.065.00 |
| | | Lampada PH16WY 12V <i>Bulb PH16WY 12V</i> | | 5.42.062.99 |
| | | | | |



| RENAULT | | PREMIUM KERAX | | |
|---|-------|--|--|--------------------|
|  | 99→04 | Fanale laterale incolore <i>Clear side lamp</i> |   | 5.43.056.00 |
| | | Fanale laterale incolore <i>Clear side lamp</i> |   | 2.42.078.00 |
| | | Portalampada <i>Bulb holder</i> | | 2.42.076.18 |



| RENAULT | | PREMIUM MIDLUM | | |
|---|-----|---|--|--------------------|
|  | 00→ | Gruppo ottico direzione su pedana nero <i>Direction optical unit on black platform</i> |   | 5.43.058.00 |
| | | Portalampage <i>Bulb holder</i> | | 1.09.052.00 |



| RENAULT | | PREMIUM | | |
|---|-----|---|--|--------------------|
|  | 97→ | Gruppo ottico direzione su pedana nero <i>Direction optical unit on black platform</i> |   | 2.43.218.00 |
| | | Portalampage <i>Bulb holder</i> | | 1.09.052.00 |

*** Ricambio di qualità equivalente | Matching quality spare parts**

| SCANIA | | LED | | |
|---|-----|---|--|--------------------|
|  | 98→ | Fanale laterale con cavo 4 led <i>4 led side lamp with cable</i> |   | 2.42.137.80 |
| | | * Ricambio di qualità equivalente Matching quality spare parts | | |

| SCANIA | | R-P | | |
|---|-----|---|--|--------------------|
|  | 07→ | Fanale laterale con catadiottro <i>Side lamp with reflex-reflector</i> |   | 2.42.092.00 |
| | | * Ricambio di qualità equivalente Matching quality spare parts | | |

| SETRA | | BUS | | LED |
|---|---|---|--|--------------------|
|  | | Fanale laterale <i>Side lamp</i> |   | 2.42.062.80 |
| | | 24V | | |
| | |  | | |
| | | * Ricambio di qualità equivalente <i>Matching quality spare parts</i> | | |
| VOLVO | | BUS COACH | | LED |
|  | | Fanale laterale 4 led <i>4 led side lamp</i> |   | 5.42.072.80 |
| | 00→ | Fanale laterale 4 led <i>4 led side lamp</i> |   | 2.42.108.80 |
| | | 24V | | |
| VOLVO | | BUS-RENAULT-IVECO | | LED |
|  | | Fanale laterale arancio 4 led <i>4 led side lamp</i> |   | 2.42.128.80 |
| | | * Ricambio di qualità equivalente <i>Matching quality spare parts</i> | | |
| VOLVO | | BUS | | LED |
|  | | Fanale laterale incolore <i>Clear side lamp</i> |   | 2.42.110.80 |
| | | * Ricambio di qualità equivalente <i>Matching quality spare parts</i> | | |
| VOLVO SCANIA | | FH FM S3/4 | | LED |
|  | | Fanale laterale ingombro <i>Side marker</i> |   | 2.42.100.80 |
| | 02→ | | | |
| | | 24V | | |
| | * Ricambio di qualità equivalente <i>Matching quality spare parts</i> | | | |





| VOLVO | | FH16 FM | |
|---|---|---|----------------------|
|  | 02→ | Fanale laterale con base bianca <i>Side lamp with clear base</i> | ➔ 2.42.054.00 |
| | | Fanale laterale con base bianca <i>Side lamp with clear base</i> | ➔ 2.42.055.00 |
| | * Ricambio di qualità equivalente Matching quality spare parts | | |

| VOLVO | | FH16 FM | |
|---|---|--|----------------------|
|  | | Fanale laterale arancio <i>Orange side lamp</i> | ➔ 2.42.052.00 |
| | | Fanale laterale arancio <i>Orange side lamp</i> | ➔ 2.42.053.00 |
| | * Ricambio di qualità equivalente Matching quality spare parts | | |

| VOLVO | | FM FMX 4ª SERIE | |
|---|---|---|----------------------|
|  | 05→12 | Indicatore di direzione incolore <i>Clear lamp</i> | ➔ 2.41.336.00 |
| | | Indicatore di direzione incolore <i>Clear lamp</i> | ➔ 2.41.337.00 |
| | * Ricambio di qualità equivalente Matching quality spare parts | | |

| VOLVO | | FM FMX 4ª SERIE | | LED | |
|---|---|---|---|--------------------|--|
|  | 14→ | Fanale laterale corpo nero <i>Black body side lamp</i> | ➔ | 2.42.138.80 | |
| | | Fanale laterale corpo nero <i>Black body side lamp</i> | ➔ | 2.42.139.80 | |
| | * Ricambio di qualità equivalente Matching quality spare parts | | | | |

| VOLVO | | FM FMX 4ª SERIE | | LED | |
|---|---|-------------------------------------|---|--------------------|--|
|  | 14→ | Fanale laterale <i>Side lamp</i> | ➔ | 2.42.140.80 | |
| | | Fanale laterale <i>Side lamp</i> | ➔ | 2.42.141.80 | |
| | * Ricambio di qualità equivalente Matching quality spare parts | | | | |

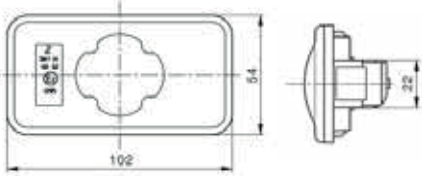
| VOLVO | BUS COACH | LED |
|---|--|--|
|  | Fanale laterale ingombro <i>Side lamp driver marker</i> |   5.42.076.80 |
| | Fanale laterale ingombro <i>Side lamp driver marker</i> |   2.42.098.80 |
| | 01→ 24V  | |
| * Ricambio di qualità equivalente Matching quality spare parts | | |

| DAF IVECO MAN MERCEDES | | VARIOUS MODELS | | LED |
|---|-------------------------------|---|---|--------------------|
|  | 09→ | Segnalatore ingombro cabina led <i>Led driver's cab side marker</i> | ↔ | 4.43.058.80 |
| | | 24V | | |
| DAF | XF | | | LED |
|  | | Fanale ingombro con cavo cm. 30 <i>Side marker with cable cm. 30</i> | ↔ | 2.43.091.80 |
| | | * Ricambio di qualità equivalente Matching quality spare parts | | |
| DAF | XF95 XF10 | | | LED |
|  | 08→ | Fanale ingombro cabina led <i>Led driver's cab side marker</i> | ↔ | 2.43.260.80 |
| | | 24V | | |
| | | * Ricambio di qualità equivalente Matching quality spare parts | | |
| FIAT IVECO | | | | |
|  | | Segnalatore ingombro cabina incolore <i>Clear driver's cab side marker</i> | ↔ | 1.43.058.00 |
| | | Segnalatore ingombro rosso <i>Red side marker</i> | ↔ | 1.43.060.00 |
| | | | | |
| IVECO | DAILY S. 2000 DAILY MY 2006 | | | |
|  | 99→ | Segnalatore ingombro cabina <i>Driver's cab side marker</i> | ↔ | 1.43.050.00 |
| | | Segnalatore ingombro cabina <i>Driver's cab side marker</i> | ↔ | 1.43.051.00 |

| IVECO | | DAILY 2014 | |
|---|-----|---|----------------------|
|  | 14→ | Fanale ingombro cabina <i>Driver's cab side marker</i> | → 5.43.062.00 |
| | | Fanale ingombro cabina <i>Driver's cab side marker</i> | ← 5.43.063.00 |
| | | | |

| IVECO | | EUROCARGO EUROTECH | |
|---|-----|---|----------------------|
|  | 91→ | Segnalatore ingombro con braccio rigido <i>Side marker with hard arm</i> | → 1.43.052.00 |
| | | Segnalatore ingombro con braccio rigido <i>Side marker with hard arm</i> | ← 1.43.053.00 |
| | | | |

| IVECO | | EUROCARGO | |
|---|-----|--|---------------------------|
|  | 91→ | Segnalatore ingombro cabina <i>Driver's cab side marker</i> | → ← 1.43.054.00 |
| | | | |
| | | | |

| IVECO | | EUROCARGO | |
|---|-----|--|---------------------------|
|  | 91→ | Segnalatore ingombro cabina <i>Driver's cab side marker</i> | → ← 1.43.056.00 |
| | | | |
| | | | |

| IVECO | | EUROCARGO | |
|---|-----|--|----------------------|
|  | 03→ | Segnalatore ingombro cabina <i>Driver's cab side marker</i> | → 1.43.076.00 |
| | | Segnalatore ingombro cabina <i>Driver's cab side marker</i> | ← 1.43.077.00 |
| | | | |

















| IVECO | STRALIS | | | |
|---|---------|--|---|--------------------|
|  | 03→ | Segnalatore ingombro cabina <i>Driver's cab side marker</i> | → | 1.43.068.00 |
| | | Segnalatore ingombro cabina <i>Driver's cab side marker</i> | ← | 1.43.069.00 |
| | | | | |



| IVECO | STRALIS | | | |
|---|---------|--|---|--------------------|
|  | 10→ | Segnalatore ingombro cabina <i>Driver's cab side marker</i> | → | 1.43.078.00 |
| | | Segnalatore ingombro cabina <i>Driver's cab side marker</i> | ← | 1.43.079.00 |
| | | | | |

| IVECO | STRALIS | LED | | |
|---|---------|---|---|--------------------|
|  | 13→ | Ingombro visiera <i>Sun visor's marker</i> | → | 1.43.080.80 |
| | | Ingombro visiera <i>Sun visor's marker</i> | ← | 1.43.081.80 |
| | | 24V | | |

| IVECO | STRALIS EUROCARGO | | | |
|---|---------------------|--|---|--------------------|
|  | 91→ | Segnalatore incolore <i>Clear side marker</i> | → | 1.43.064.00 |
| | | | ← | |
| | | | | |

| IVECO | STRALIS EUROCARGO EUROTECH | | | |
|---|--------------------------------|--|---|--------------------|
|  | 91→ | Segnalatore ingombro cabina <i>Driver's cab side marker</i> | → | 2.43.326.00 |
| | | Segnalatore ingombro cabina <i>Driver's cab side marker</i> | ← | 2.43.327.00 |
| | | | * Ricambio di qualità equivalente Matching quality spare parts | |

| IVECO | | STRALIS EUROCARGO EUROTECH | | | |
|---|---|--|--|--------------------|---|
|  | 91→ | Ingombro visiera <i>Sun visor's marker</i> |  2.43.328.00 | | |
| | | Ingombro visiera <i>Sun visor's marker</i> |  2.43.329.00 | | |
| | * Ricambio di qualità equivalente <i>Matching quality spare parts</i> | | | | |
| IVECO | | STRALIS | | | |
|  | 03→ | Segnalatore ingombro cabina <i>Driver's cab side marker</i> |  1.43.070.00 | | |
| | | Segnalatore ingombro cabina <i>Driver's cab side marker</i> |  1.43.071.00 | | |
| | * Ricambio di qualità equivalente <i>Matching quality spare parts</i> | | | | |
| EVOBUS SETRA | | 315 H | | LED | |
|  | 05→ | Fanale ingombro laterale arancio <i>Orange side lamp marker</i> |  | 2.43.052.80 |  |
| | | 24V | * Ricambio di qualità equivalente <i>Matching quality spare parts</i> | | |
| | * Ricambio di qualità equivalente <i>Matching quality spare parts</i> | | | | |
| MAN | | TGA | | LED | |
|  | | Fanale ingombro cabina <i>Driver cab marker</i> |  | 2.43.132.80 |  |
| | | 24V | * Ricambio di qualità equivalente <i>Matching quality spare parts</i> | | |
| | * Ricambio di qualità equivalente <i>Matching quality spare parts</i> | | | | |
| MERCEDES | | ATEGO AXOR | | LED | |
|  | 06→ | Fanale ingombro cabina incolore <i>Clear driver cab marker</i> |  | 2.43.334.80 |  |
| | | Fanale ingombro cabina incolore <i>Clear driver cab marker</i> |  | | |
| | * Ricambio di qualità equivalente <i>Matching quality spare parts</i> | | | | |







| RENAULT | | PREMIUM MIDLUM | | |
|---|-----|---|--|--------------------|
|  | 00→ | Luce ingombro anteriore <i>Front marker lamp</i> | | 5.43.060.00 |
| | |  | | |



| RENAULT | | PREMIUM I-MIDLUM-KERAX | | |
|---|-----|--|--------|--------------------|
|  | 00→ | Luce ingombro anteriore <i>Front marker lamp</i> | → ← | 2.41.326.00 |
| | | Portalampada <i>Bulb holder</i> | | 2.41.326.18 |
| | | R5W * Ricambio di qualità equivalente Matching quality spare parts | | |



| SCANIA | | P G R | | LED |
|---|-----|--|---|--------------------|
|  | 16→ | Fanale ingombro <i>Side marker</i> | → | 2.43.338.80 |
| | | Fanale ingombro <i>Side marker</i> | ← | 2.43.339.80 |
| | | * Ricambio di qualità equivalente Matching quality spare parts | | |







| SCANIA | | R9 6 T L S | | LED |
|---|-----|--|--------|--------------------|
|  | 07→ | Fanale ingombro <i>Side marker</i> | → ← | 2.43.340.80 |
| | | * Ricambio di qualità equivalente Matching quality spare parts | | |





| SCANIA | | SERIE R | | LED | |
|---|-----|--|--------|--------------------|--|
|  | 09→ | Ingombro visiera incolore <i>Clear sun visor's marker</i> | → ← | 2.43.140.80 | |
| | | Ingombro visiera arancio <i>Orange sun visor's marker</i> | → ← | 2.43.141.80 | |
| | | 24V | | | |
| | | * Ricambio di qualità equivalente Matching quality spare parts | | | |



| VOLVO | | FH FMX 4 ^a SERIE | | LED |
|---|-------|---|--|--------------------|
|  | 05→12 | Fanale ingombro cabina arancio <i>Orange driver's cab marker</i> |   | 2.43.330.80 |
| | | Fanale ingombro cabina incolore <i>Clear driver's cab marker</i> |   | 2.43.331.80 |
| | | Fanale ingombro cabina verde <i>Green driver's cab marker</i> |   | 2.43.332.80 |
| | | * Ricambio di qualità equivalente <i>Matching quality spare parts</i> | | |



| VOLVO | | FH (FH13) | | LED |
|---|---|---------------------------------------|---|--------------------|
|  | | Fanale laterale <i>Side marker</i> |  | 2.43.130.80 |
| | | Fanale laterale <i>Side marker</i> |  | 2.43.131.80 |
| | | 24V | | |
| | * Ricambio di qualità equivalente <i>Matching quality spare parts</i> | | | |

| UNIVERSALE | | FLATPOINT | | |
|---|--|--|--|--------------------|
|  | | Fanale laterale con cavo cm 50 staffa e protezione <i>Side lamp with 50 cm cable bracket and protection</i> |   | 7.43.060.31 |
| | | | | |



| UNIVERSALE | | BUS | | |
|---|---|---|--|--------------------|
|  | | Segnalatore ingombro arancio <i>Orange side marker</i> |   | 2.43.048.00 |
| | | Gruppo ottico ingombro arancio <i>Orange side optical unit</i> |   | 2.43.048.11 |
| | | Segnalatore ingombro incolore <i>Clear side marker</i> |   | 2.43.040.00 |
| | | Portalampane <i>Bulb holder</i> | | 2.43.048.18 |
| | * Ricambio di qualità equivalente <i>Matching quality spare parts</i> | | | |

| UNIVERSALE | BUS | | |
|---|---|---|--------------------|
|  | Segnalatore ingombro incolore <i>Clear side marker</i> |   | 2.43.320.00 |
| | Segnalatore ingombro rosso <i>Red side marker</i> |   | 2.43.322.00 |
| | Portalampane <i>Bulb holder</i> | | 1.09.050.00 |
| * Ricambio di qualità equivalente Matching quality spare parts | | | |

| UNIVERSALE | BUS | | |
|---|---|---|--------------------|
|  | Segnalatore ingombro con catadriotto rosso <i>Side marker with red reflector</i> |   | 2.43.280.00 |
| | Portalampane <i>Bulb holder</i> | | 1.09.050.00 |
| * Ricambio di qualità equivalente Matching quality spare parts | | | |

| UNIVERSALE | BUS | | LED |
|---|--|---|--------------------|
|  | Segnalatore ingombro <i>Side marker</i> |   | 2.43.336.80 |
| | Dimensioni / Dimension 144x82x29 mm. | | |
| * Ricambio di qualità equivalente Matching quality spare parts | | | |

| UNIVERSALE | | | |
|---|---|---|--------------------|
|  | Segnalatore ingombro arancio <i>Orange side marker</i> |   | 2.43.142.00 |
| | Segnalatore ingombro rosso incolore <i>Red/clear side marker</i> |   | 2.43.144.00 |
| * Articolo universale Universal part | | | |

| UNIVERSALE | | | |
|---|---|---|--------------------|
|  | Segnalatore ingombro rosso incolore <i>Red clear side marker</i> |   | 2.43.145.00 |
| * Articolo universale Universal part | | | |

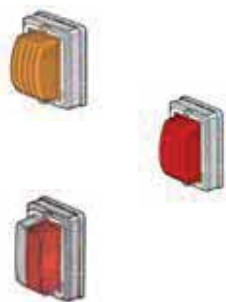
UNIVERSALE

Segnalatore ingombro arancio

Orange side marker

2.43.146.00

Segnalatore ingombro rosso

Red side marker

2.43.147.00

Segnalatore ingombro rosso/incolore

Red/clear side marker

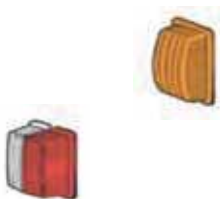
2.43.148.00
*** Articolo universale | Universal part**
UNIVERSALE

Trasparente arancio

Orange lens

2.43.142.24

Trasparente rosso|incolore

Red/clear lens

2.43.142.26
*** Articolo universale | Universal part**
UNIVERSALE

Side marker arancio senza catadiottro con staffa

Orange side marker without reflector with bracket

2.43.250.00

Side marker rosso senza catadiottro con staffa

Red side marker without reflector with bracket

2.43.252.00

Sidemarker incolore senza catadiottro con staffa

Clear side marker without reflector with bracket

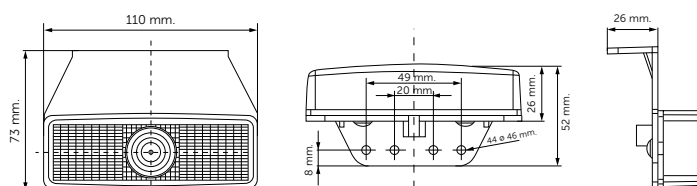
2.43.248.00

*** Articolo universale | Universal part**
UNIVERSALE

Sidemarker base piana con catadiottro

Flat base side marker with reflector

2.43.099.00

Trasparente

Lens

2.43.098.24
*** Ricambio di qualità equivalente | Matching quality spare parts**

UNIVERSALE



Side marker con catadiottro e staffa
Side marker with reflector and bracket



2.43.098.00

Trasparente
Lens



2.43.098.24

* Ricambio di qualità equivalente | *Matching quality spare parts*

UNIVERSALE



Fanale ingombro con catadiottro arancio
Side marker with orange reflector



2.43.062.40

Portalampane
Bulb holder

2.43.064.18

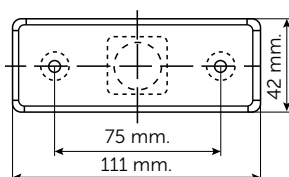

* Ricambio di qualità equivalente | *Matching quality spare parts*

UNIVERSALE



Fanale ingombro senza catadiottro
Side marker without reflector



2.43.100.00

Trasparente
Lens



2.43.100.24

* Articolo universale | *Universal part*

UNIVERSALE



Fanale ingombro con staffa senza catadiottro
Side marker with bracket without reflector



2.43.325.00

* Articolo universale | *Universal part*

UNIVERSALE







| | | |
|---|--|--------------------|
| Segnalatore ingombro arancio <i>Orange side marker</i> | | 2.43.220.00 |
| Trasparente arancio <i>Orange lens</i> | | 2.43.220.24 |
| Segnalatore ingombro rosso <i>Red side marker</i> | | 2.43.221.00 |
| Trasparente rosso <i>Red lens</i> | | 2.43.220.22 |
| Segnalatore ingombro incolore <i>Clear side marker</i> | | 2.43.222.00 |
| Trasparente incolore <i>Clear lens</i> | | 2.43.220.25 |
| Segnalatore ingombro blu <i>Blue side marker</i> | | 2.43.223.00 |





*** Articolo universale | Universal part**

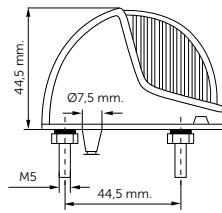



UNIVERSALE

| | | |
|---|--|--------------------|
| Segnalatore ingombro rosso <i>Red side marker</i> | | 2.43.226.00 |
| Trasparente rosso <i>Red lens</i> | | 2.43.220.22 |
| Trasparente incolore/rosso <i>Red/clear lens</i> | | 2.43.224.26 |
| Segnalatore ingombro arancio <i>Orange side marker</i> | | 2.43.228.00 |
| Trasparente arancio <i>Orange lens</i> | | 2.43.220.24 |
| Segnalatore ingombro incolore <i>Clear side marker</i> | | 2.43.230.00 |
| Trasparente incolore <i>Clear lens</i> | | 2.43.220.25 |

*** Articolo universale | Universal part**

| UNIVERSALE | AUTOBUS | | |
|---|---|--|--|
|  | Fanale ingombro cabina incolore <i>Clear driver's cab marker</i> |   | 2.43.112.00 |
| | Fanale ingombro cabina rosso <i>Red driver's cab marker</i> |   | 2.43.114.00 |
| |  | | <p>* Articolo universale Universal part</p> |

| UNIVERSALE | | | |
|--|---|---|---|
|  | Fanale ingombro arancio <i>Orange side marker</i> |   | 5.43.054.00 |
| | Con passacavo - dimensioni 950x200 mm. - Lampada <i>With fairlead - Dimension 950x200 mm. - Bulb T4W</i> | |  |

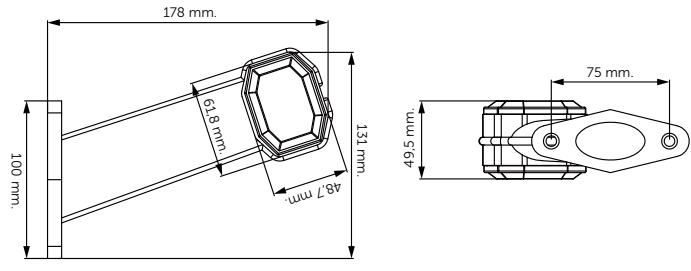
| UNIVERSALE | | | |
|---|---|--|--|
|  | Fanale ingombro con cavo <i>Side marker with cable</i> |  | 2.43.044.00 |
| | Fanale ingombro con cavo <i>Side marker with cable</i> |  | 2.43.045.00 |
| | Gruppo ottico ingombro <i>Side optical unit</i> |   | 2.43.044.10 |
| | Con cavo 50 cm. / <i>With cable 50 cm.</i> | |  |
| <p>* Ricambio di qualità equivalente Matching quality spare parts</p> | | | |

UNIVERSALE

Fanale ingombro braccio gomma rosso - incolore
Side marker with red - clear rubber arm



2.43.050.00

Fanale ingombro braccio gomma rosso - incolore
Side marker with red - clear rubber arm



2.43.051.00

Gruppo ottico ingombro
Side optical unit



2.43.044.10

Con cavo 50 cm. | *With cable 50 cm.*

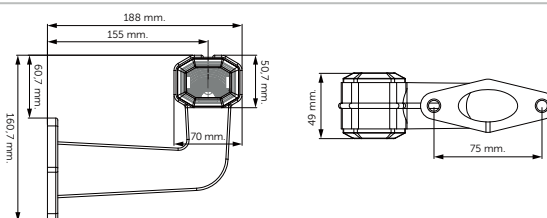

*** Ricambio di qualità equivalente | Matching quality spare parts**

UNIVERSALE

Fanale ingombro con cavo
Side marker with cable



2.43.046.00

Gruppo ottico ingombro
Side optical unit



2.43.044.10

Con cavo 50 cm. | *With cable 50 cm.*

*** Ricambio di qualità equivalente | Matching quality spare parts**

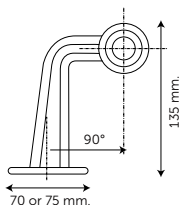
UNIVERSALE

Fanale ingombro braccio gomma rosso - incolore
Side marker with red - clear rubber arm



2.43.126.00

Trasparente incolore
Clear lens



2.43.072.25

Trasparente rosso
Red lens



2.43.072.22

Portalampane
Bulb holder

2.43.072.18

*** Ricambio di qualità equivalente | Matching quality spare parts**

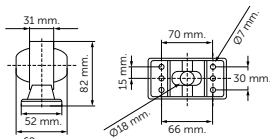
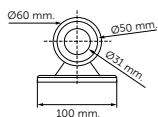
UNIVERSALE

Fanale ingombro braccio gomma rosso - incolore
Side marker with red - clear rubber arm

2.43.082.00

Trasparente incolore
Clear lens

2.43.072.25

Trasparente rosso
Red lens

2.43.072.22

Portalampade
Bulb holder

2.43.072.18

*** Ricambio di qualità equivalente | Matching quality spare parts**

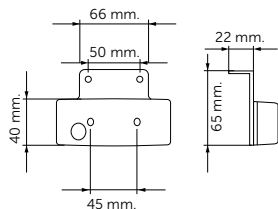
UNIVERSALE

Fanale ingombro arancio con staffa - con catadiottero
Orange side marker with bracket - with reflector

2.43.068.00

Trasparente
Lens

2.43.068.24

*** Ricambio di qualità equivalente | Matching quality spare parts**

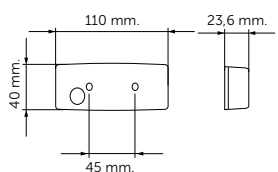
UNIVERSALE

Fanale ingombro arancio senza staffa
Orange side marker without bracket



2.43.070.00

Trasparente
Lens

2.43.068.24

*** Ricambio di qualità equivalente | Matching quality spare parts**

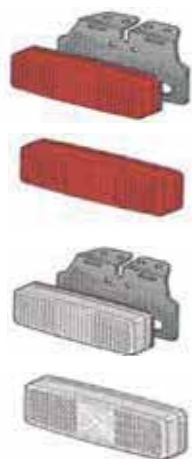
UNIVERSALE



| | | |
|--|------|--------------------|
| Fanale ingombro rosso con catadiottero <i>Red side marker with reflector</i> | | 2.43.182.00 |
| Trasparente rosso con catadiottero <i>Red lens with reflector</i> | | 2.43.182.21 |
| Fanale ingombro incolore con catadiottero <i>Clear side marker with reflector</i> | | 2.43.184.00 |
| Trasparente incolore con catadiottero <i>Clear lens with reflector</i> | | 2.43.184.25 |

* **Ricambio di qualità equivalente | Matching quality spare parts**

UNIVERSALE

LED



| | | |
|--|------|--------------------|
| Fanale ingombro incolore <i>Clear side marker</i> | | 2.43.116.80 |
| Fanale ingombro rosso <i>Red side marker</i> | | 2.43.118.80 |
| Fanale ingombro arancio <i>Orange side marker</i> | | 2.43.120.80 |

6 led
24V
Dimensioni / Dimension 220x340 mm.

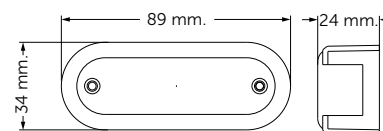

* **Ricambio di qualità equivalente | Matching quality spare parts**

UNIVERSALE

LED



| | | |
|---|------|--------------------|
| Segnalatore ingombro arancio <i>Orange side marker</i> | | 2.43.194.80 |
|---|------|--------------------|

Dimensioni / Dimension 110x72 mm.
Con cavo 500 mm. / With 500 mm. cable

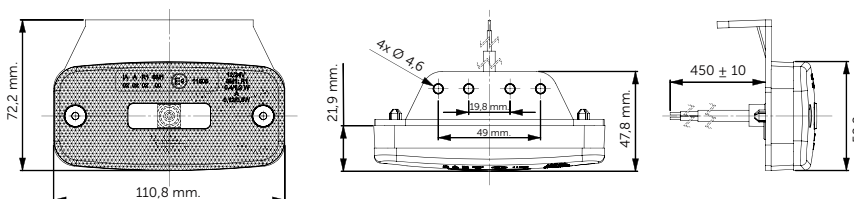

12-24V

* **Ricambio di qualità equivalente | Matching quality spare parts**

UNIVERSALE

Segnalatore ingombro rosso/incolore
Red/clear side marker

2.43.089.00

Trasparente rosso/incolore
Red/clear lens

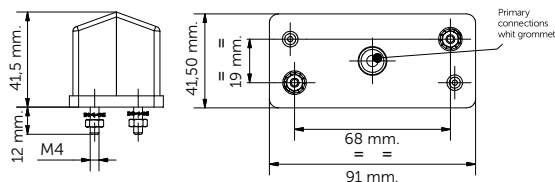
2.43.088.26

* **Ricambio di qualità equivalente | Matching quality spare parts**

UNIVERSALE

Segnalatore ingombro rosso/incolore con staffa
Red/clear side marker with bracket

2.43.088.00

Trasparente rosso/incolore
Red/clear lens

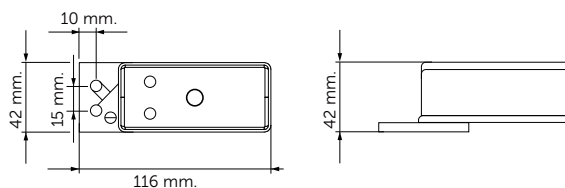
2.43.088.26

* **Ricambio di qualità equivalente | Matching quality spare parts**

UNIVERSALE
LED



Segnalatore ingombro incolore con staffa
Clear side marker with bracket

2.43.196.80

Segnalatore ingombro arancio con staffa
Orange side marker with bracket

2.43.198.80

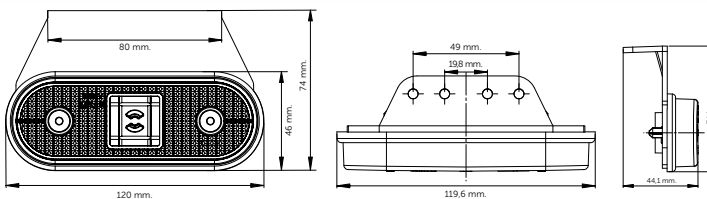
Segnalatore ingombro rosso con staffa
Red side marker with bracket









2.43.200.80





Dimensioni / *Dimension* 120x45 mm.

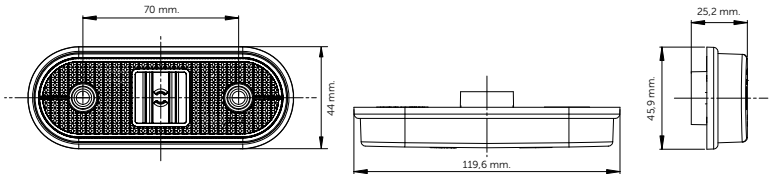







Con cavo 500 mm. | *With 500 mm. cable*





12-24V







* **Ricambio di qualità equivalente | Matching quality spare parts**







| UNIVERSALE | | | LED |
|--|---|--|--------------------|
|  | Segnalatore ingombro incolore <i>Clear side marker</i> |   | 2.43.197.80 |
| | Segnalatore ingombro arancio <i>Orange side marker</i> |   | 2.43.199.80 |
| | Segnalatore ingombro rosso <i>Red side marker</i> |   | 2.43.201.80 |
|  | | | |
| Dimensioni / Dimension 120x45 mm. Con cavo 500 mm. With 500 mm. cable | | | |
| 12-24V | | | |
| * Ricambio di qualità equivalente Matching quality spare parts | | | |







| UNIVERSALE | MODELLO FLATPOINT | | |
|---|--|--|--------------------|
|  | Fanale laterale incolore con cavo cm 50 staffa e protezione <i>Clear side lamp with 50 cm cable with bracket</i> |   | 7.43.064.41 |
| 24V | | | |







| UNIVERSALE | MODELLO FLATPOINT | | LED |
|---|---|--|--------------------|
|  | Fanale laterale incolore led con cavo cm 50 staffa <i>Clear led side lamp with 50 cm cable with bracket</i> |   | 7.43.086.81 |
|  | Fanale laterale arancio led con cavo cm 50 staffa e protezione <i>Orange led side lamp with 50 cm cable with bracket and protection</i> |   | 7.43.084.81 |
|  | Fanale laterale arancio led con staffa e protezione 90° senza cavo <i>Orange led side lamp with bracket and protection 90° without cable</i> |   | 7.43.080.81 |





| UNIVERSALE | UNIPOINT | LED |
|---|--|--|
|  | Fanale laterale con cavo cm 25 e staffa 90° <i>Side lamp with 25 cm cable and 90° bracket</i> |   7.43.074.81 |
| | Fanale laterale con cavo cm. 25 con staffa <i>Side lamp with 25 cm cable with bracket</i> |   7.43.078.81 |
| | 24V | |

| UNIVERSALE | LED | |
|--|--|---|
|  | Segnalatore ingombro arancio con staffa <i>Orange side marker with bracket</i> |   2.43.158.80 |
| | Segnalatore ingombro incolore con staffa <i>Clear side marker with bracket</i> |   2.43.162.80 |
| | Segnalatore ingombro rosso con staffa <i>Red side marker with bracket</i> |   2.43.166.80 |
| | Dimensioni / Dimension 95x30 mm. Con cavo 60 mm. e rubacorrente With 60 mm. cable and cable clamp | |
| 12-24V | | |
| * Ricambio di qualità equivalente Matching quality spare parts | | |

| UNIVERSALE | LED | |
|---|--|--|
|  | Segnalatore ingombro arancio <i>Clear side marker</i> |   2.43.160.80 |
| | Segnalatore ingombro incolore <i>Clear side marker</i> |   2.43.164.80 |
| | Segnalatore ingombro rosso <i>Red side marker</i> |   2.43.168.80 |
| | Dimensioni / Dimension 95x30 mm. Con cavo 60 mm. e rubacorrente With 60 mm. cable and cable clamp | |
| 12-24V | | |
| * Ricambio di qualità equivalente Matching quality spare parts | | |

| UNIVERSALE | | LED | |
|---|--|--|--------------------|
|  | Side marker arancio con staffa <i>Orange side marker with bracket</i> |   | 2.43.170.80 |
| | Side marker incolore con staffa <i>Clear side marker with bracket</i> |   | 2.43.174.80 |
| | Side marker rosso con staffa <i>Red side marker with bracket</i> |   | 2.43.178.80 |
| Dimensioni / <i>Dimension</i> 110x50 mm. Con cavo 60 mm. e rubacorrente <i>With 60 mm. cable and cable clamp</i> | | | |
| 12-24V | | | |
| * Ricambio di qualità equivalente Matching quality spare parts | | | |

| UNIVERSALE | | LED | |
|---|--|--|--------------------|
|  | Segnalatore arancio <i>Orange side marker</i> |   | 2.43.172.80 |
| | Segnalatore incolore <i>Clear side marker</i> |   | 2.43.176.80 |
| | Segnalatore rosso <i>Red side marker</i> |   | 2.43.180.80 |
| Dimensioni / <i>Dimension</i> 110x50 mm. Con cavo 60 mm. e rubacorrente <i>With 60 mm. cable and cable clamp</i> | | | |
| 12-24V | | | |
| * Ricambio di qualità equivalente Matching quality spare parts | | | |

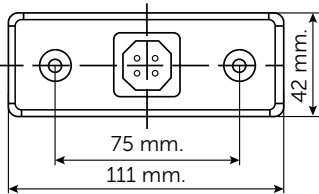
| UNIVERSALE | | LED | |
|---|---|--|--------------------|
|  | Fanale ingombro <i>Side marker</i> |   | 2.43.122.80 |
| | Fanale ingombro con staffa <i>Side marker with bracket</i> |   | 2.43.124.80 |
| | 24V | | |
|  | | | |
| * Ricambio di qualità equivalente Matching quality spare parts | | | |

UNIVERSALE
LED

Fanale ingombro con staffa
Side marker with bracket



2.43.054.81

24V

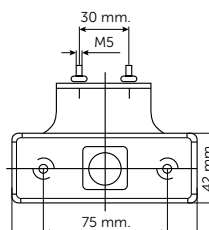

* **Ricambio di qualità equivalente | Matching quality spare parts**

UNIVERSALE
LED

Fanale ingombro arancio
Orange side marker



2.43.052.81

Fanale ingombro incolore
Clear side marker



2.43.056.81

24V

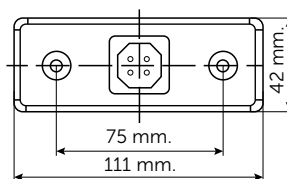

* **Ricambio di qualità equivalente | Matching quality spare parts**

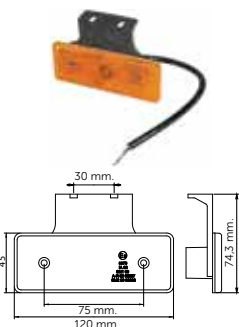
UNIVERSALE
LED

Fanale ingombro con catadiottro arancio con staffa
Side marker with orange reflector with bracket



2.43.058.81

1 led | 12-24V

* **Ricambio di qualità equivalente | Matching quality spare parts**

UNIVERSALE
LED



Fanale ingombro con catadiottro arancio senza staffa
Side marker with orange reflector without bracket













2.43.060.81









1 led | 12-24V

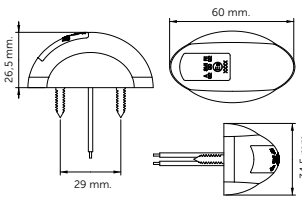







* **Ricambio di qualità equivalente | Matching quality spare parts**



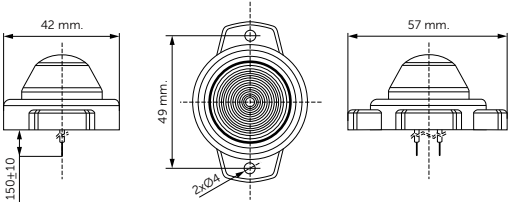

| UNIVERSALE | | LED | |
|---|---|--|--------------------|
|  | Fanale ingombro arancio <i>Orange side marker</i> |   | 2.43.048.80 |
| | 12/24V Cavo mm. 500 12/24V mm. 500 cable | | |
| | * Ricambio di qualità equivalente <i>Matching quality spare parts</i> | | |



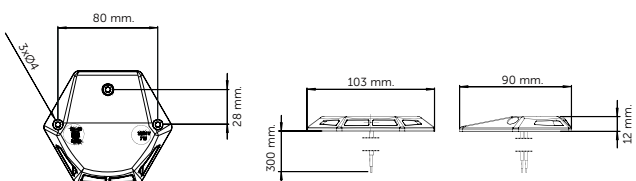



| UNIVERSALE | | LED | |
|---|---|--|--------------------|
|  | Fanale ingombro arancio con catadiottro <i>Orange side marker with reflector</i> |   | 2.43.272.80 |
| | Fanale ingombro rosso <i>Red side marker</i> |   | 2.43.274.80 |
| | Fanale ingombro incolore <i>Clear side marker</i> |   | 2.43.276.80 |
| | 24V | | |
| | * Ricambio di qualità equivalente <i>Matching quality spare parts</i> | | |

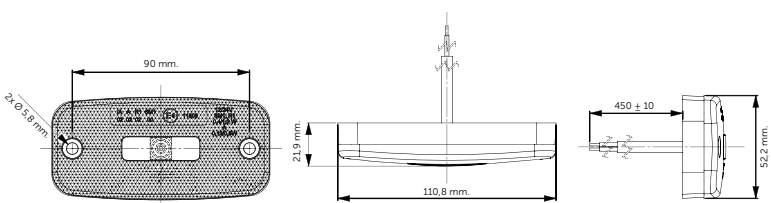

| UNIVERSALE | | LED | |
|---|---|--|--------------------|
|  | Fanale ingombro arancio con staffa - 2 serracavi <i>Orange side marker with bracket - 2 cable clamps</i> |   | 2.43.292.80 |
| | 24V | | |
| | * Ricambio di qualità equivalente <i>Matching quality spare parts</i> | | |



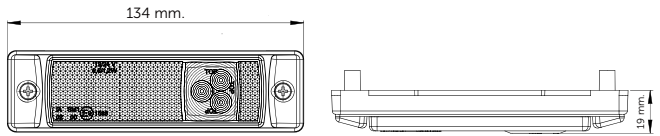

| UNIVERSALE | | LED | |
|--|---|--|--------------------|
|   | Side marker incolore/rosso <i>Clear/red side marker</i> |   | 2.43.238.80 |
| | Side marker arancio <i>Orange side marker</i> |   | 2.43.240.80 |
| | Side marker rosso <i>Red side marker</i> |   | 2.43.242.80 |
| | Side marker incolore <i>Clear side marker</i> |   | 2.43.244.80 |
| | Consumo <i>Consumption: 1,4W/1,4W per doppia funzione for double function</i> Consumo <i>Consumption: 0,7W/1,4W per singola funzione for single function</i> | | |
| | 10-30V | | |
| * Articolo universale <i>Universal part</i> | | | |



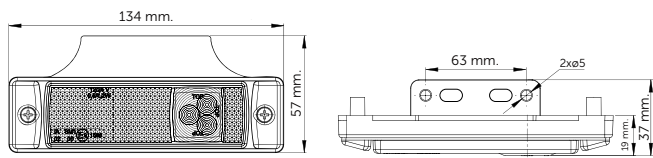



| UNIVERSALE | | | LED | |
|---|---|--|---|--|
|  | | Fanale ingombro incolore <i>Clear side marker</i> |  2.43.254.80 | |
| | | Fanale ingombro rosso <i>Red side marker</i> |  2.43.255.80 | |
| | Fissaggio 2 viti <i>2 screws fixing</i> Potenza assorbita <i>Absorbed power: 0,4/0,8 W</i> | | | |
| |  | | | |
| | 12-24V * Articolo universale Universal part | | | |
| UNIVERSALE | | | LED | |
|  | | Side marker arancio con catadiottro <i>Orange side marker with reflector</i> |  2.43.256.80 | |
| | | Side marker rosso con catadiottro <i>Red side marker with reflector</i> |  2.43.257.80 | |
| | | Side marker incolore con catadiottro <i>Clear side marker with reflector</i> |  2.43.258.80 | |
| | 24V Dimensioni / <i>Dimension mm. 100x38</i> * Articolo universale Universal part | | | |
| UNIVERSALE | | | LED | |
|  | | Spia per sponde montacarichi <i>Lights for goods lift</i> Fissaggio 3 viti <i>3 screws fixing</i> Potenza assorbita <i>Absorbed power: 7 W</i> |  2.43.246.80 | |
| | 12-24V |  | | |
| * Articolo universale Universal part | | | | |



| UNIVERSALE | | | LED |
|---|--|--|--------------------|
|  | Fanale ingombro rosso con cavo mm. 500 <i>Red side marker with cable mm. 500</i> |   | 2.43.195.80 |
| | Fanale ingombro incolore con cavo mm. 500 <i>Clear side marker with cable mm. 500</i> |   | 2.43.195.81 |
| Consumo Consumption: 1,4W/1,4W per doppia funzione / for double function Consumo Consumption: 0,7W/1,4W per singola funzione / for single function | | | |
|  | | | |
| 12-24V | | | |
| * Articolo universale Universal part | | | |

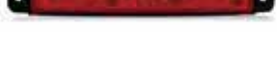

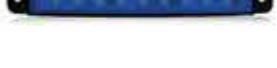



| UNIVERSALE | | | LED |
|---|---|--|--------------------|
|  | Fanale ingombro base piana rosso <i>Red side marker flat base</i> |   | 2.43.096.80 |
| | Fanale ingombro base piana incolore <i>Clear side marker flat base</i> |   | 2.43.094.80 |
| | Fanale ingombro base piana arancio <i>Orange side marker flat base</i> |   | 2.43.090.80 |
| 3 led 12-24V | |  | |
| * Ricambio di qualità equivalente Matching quality spare parts | | | |



| UNIVERSALE | | | LED |
|---|--|--|--------------------|
|  | Fanale ingombro con staffa <i>Side marker with bracket</i> |   | 2.43.092.80 |
| | Con cavo 50 cm. <i>With wiring 50 cm.</i> 3 led 12-24V |  | |
| * Ricambio di qualità equivalente Matching quality spare parts | | | |

| UNIVERSALE | | LED | |
|---|--|------------------------------|--------------------|
|  | Side marker arancio <i>Orange side marker</i> | → ← | 1.43.082.80 |
|  | Side marker rosso <i>Red side marker</i> | → ← | 1.43.083.80 |
|  | Side marker incolore <i>Clear side marker</i> | → ← | 1.43.084.80 |
|  | Side marker blu <i>Blue side marker</i> | → ← | 1.43.082.82 |
|  | Side marker verde <i>Green side marker</i> | → ← | 1.43.082.83 |
| 6 led 12-24V Dimensioni / Dimension mm. 95x20 | | | |
| * Articolo universale Universal part | | MADE IN ITALY BY OLSA | |

| UNIVERSALE | | LED | |
|---|--|------------------------------|--------------------|
|  | Side marker tricolore <i>Tricolor side marker</i> | → ← | 1.43.091.80 |
|  | Side marker arancio <i>Orange side marker</i> | → ← | 1.43.092.80 |
|  | Side marker rosso <i>Red side marker</i> | → ← | 1.43.093.80 |
|  | Side marker incolore <i>Clear side marker</i> | → ← | 1.43.094.80 |
|  | Side marker blu <i>Blue side marker</i> | → ← | 1.43.092.82 |
|  | Side marker verde <i>Green side marker</i> | → ← | 1.43.092.83 |
| 9 led 12-24V | | | |
| * Articolo universale Universal part | | MADE IN ITALY BY OLSA | |

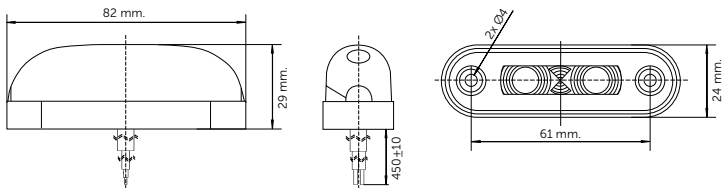
| UNIVERSALE | | | LED |
|---|--|--|--------------------|
|  | Dispositivo lampeggio side marker a led <i>Led direction device</i> |   | 1.43.001.80 |
| | | | |

| UNIVERSALE | | | LED | |
|--|--|--|---|--------------------|
|  | Segnalatore rosso <i>Red side marker</i> |   | 2.43.208.80 | |
| | Segnalatore incolore <i>Clear side marker</i> | |   | 2.43.210.80 |
| | Segnalatore arancio <i>Orange side marker</i> | |   | 2.43.212.80 |
| | 12-24V Dimensioni / Dimension 81x29 mm. | | | |
|  | | | | |
| <p>* Ricambio di qualità equivalente Matching quality spare parts</p> | | | | |

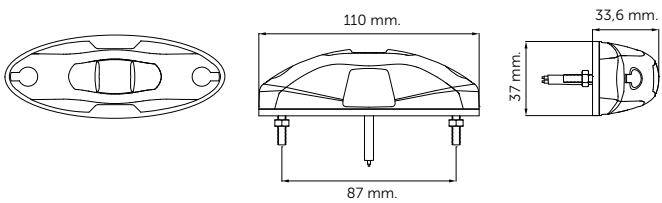
| UNIVERSALE | | | LED | |
|---|--|--|--------------------|--|
|  | Segnalatore rosso/incolore/arancio senza staffa <i>Red/clear/orange side marker without bracket</i> |   | 2.43.214.80 | |
| | 10-30V Dimensioni / Dimension 81x29 mm. | | | |
| |  | | | |
| <p>* Ricambio di qualità equivalente Matching quality spare parts</p> | | | | |

UNIVERSALE
LED

Segnalatore rosso|incoloro|arancio con staffa
Red|clear|orange side marker with bracket

2.43.216.80

10-30V | Dimensioni / Dimension 81x29 mm.

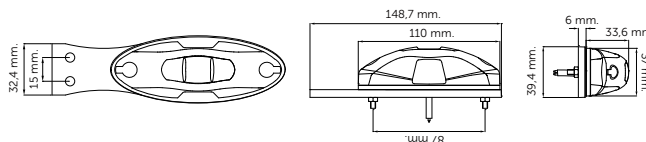

* **Ricambio di qualità equivalente | Matching quality spare parts**

UNIVERSALE
LED

Side marker arancio
Orange side marker

2.43.134.80

Side marker incolore
Clear side marker

2.43.136.80

Side marker rosso
Red side marker

2.43.138.80

24V
 Dimensioni / Dimension 101x52 mm.

* **Ricambio di qualità equivalente | Matching quality spare parts**

UNIVERSALE
LED

Segnalatore rosso
Red side marker

2.43.202.80

Segnalatore incolore
Clear side marker

2.43.204.80

Segnalatore arancio
Orange side marker

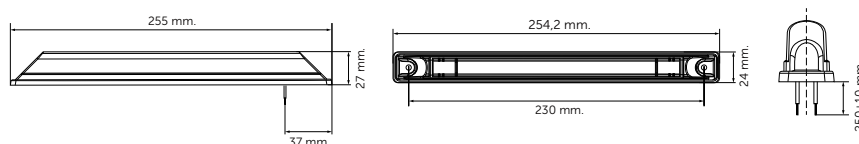

2.43.206.80

24V | Dimensioni / Dimension 250x424 mm.



* **Ricambio di qualità equivalente | Matching quality spare parts**

| UNIVERSALE | | LED 24V | |
|---|--|---------|--------------------|
|  | Fanale ingombro braccio gomma rosso - incolore <i>Red - clear side marker with rubber arm</i> | ➔ | 2.43.128.81 |
| | Fanale ingombro braccio gomma rosso - incolore <i>Red - clear side marker with rubber arm</i> | ➜ | 2.43.129.81 |
| | 24V | | |
| | * Ricambio di qualità equivalente <i>Matching quality spare parts</i> | | |

| UNIVERSALE | | LED 24V | |
|--|--|---------|--------------------|
|  | Fanale ingombro braccio gomma rosso - incolore <i>Red - clear side marker with rubber arm</i> | ➔ | 2.43.078.81 |
| | Fanale ingombro braccio gomma rosso - incolore <i>Red - clear side marker with rubber arm</i> | ➜ | 2.43.079.81 |
| | 24V | | |
| | * Ricambio di qualità equivalente <i>Matching quality spare parts</i> | | |

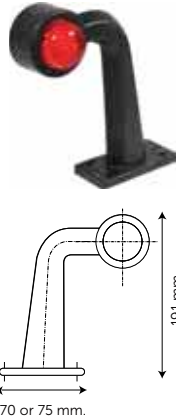
| UNIVERSALE | | LED 24V | |
|---|--|---------|--------------------|
|  | Fanale ingombro braccio gomma rosso - incolore <i>Red - clear side marker with rubber arm</i> | ➔ | 2.43.076.81 |
| | Fanale ingombro braccio gomma rosso - incolore <i>Red - clear side marker with rubber arm</i> | ➜ | 2.43.077.81 |
| | 24V | | |
| | * Ricambio di qualità equivalente <i>Matching quality spare parts</i> | | |

| UNIVERSALE | SUPERPOINT III | LED | |
|---|---|-----|--------------------|
|  | Fanale ingombro con cavo 125 cm <i>Side marker with 125 cm cable</i> | ➔ | 7.43.070.80 |
| | Fanale ingombro con cavo 125 cm <i>Side marker with 125 cm cable</i> | ➜ | 7.43.071.80 |
| | 24V | | |

| UNIVERSALE | | LED | |
|--|---|--------|--------------------|
|  | Segnalatore braccio in gomma rosso - incolore <i>Red - clear side marker with rubber arm</i> | ➔ | 2.43.186.80 |
| | Segnalatore braccio in gomma rosso - incolore <i>Red - clear side marker with rubber arm</i> | ➜ | 2.43.187.80 |
| | Segnalatore braccio in gomma rosso - incolore <i>Red - clear side maker with rubber arm</i> | ➔ | 2.43.188.80 |
| | Segnalatore braccio in gomma rosso - incolore <i>Red - clear side marker with rubber arm</i> | ➜ | 2.43.189.80 |
| | Segnalatore braccio in gomma rosso - incolore <i>Red - clear side marker with rubber arm</i> | ➔ | 2.43.190.80 |
| | Segnalatore braccio in gomma rosso - incolore <i>Red - clear side marker with rubber arm</i> | ➜ | 2.43.191.80 |
| | Segnalatore braccio in gomma rosso - incolore <i>Red - clear side marker with rubber arm</i> | ➔ | 2.43.192.80 |
| | Segnalatore braccio in gomma rosso - incolore <i>Red - clear side marker with rubber arm</i> | ➜ | 2.43.193.80 |
| | Gruppo ottico laterale con portalampada <i>Side optical unit with bulb holder</i> | ➔ ➜ | 2.43.186.81 |
| 12-24V | | | |
| * Ricambio di qualità equivalente Matching quality spare parts | | | |

| UNIVERSALE | | LED | |
|---|---|-----|--------------------|
|  | Segnalatore in gomma rosso - incolore ADR + click in <i>Red - clear side marker with rubber arm ADR + click in</i> | ➔ | 2.43.186.88 |
| | Segnalatore in gomma rosso - incolore ADR + click in <i>Red - clear side marker with rubber arm ADR + click in</i> | ➜ | 2.43.187.88 |
| | Segnalatore in gomma rosso - incolore ADR + click in <i>Red - clear side marker with rubber ADR + click in</i> | ➔ | 2.43.188.88 |
| | Segnalatore in gomma rosso - incolore ADR + click in <i>Red - clear side marker with rubber arm ADR + click in</i> | ➜ | 2.43.189.88 |
| | Segnalatore in gomma rosso - incolore ADR + click in <i>Red - clear side marker with rubber arm ADR + click in</i> | ➔ | 2.43.190.88 |
| | Segnalatore in gomma rosso - incolore ADR + click in <i>Red - clear side marker with rubber arm ADR + click in</i> | ➜ | 2.43.191.88 |
| 24V Cavo 50 cm. Cable 50 cm. | | | |
| * Ricambio di qualità equivalente Matching quality spare parts | | | |

UNIVERSALE

LED



Segnalatore braccio in gomma incolore - rosso - arancio
Clear - red - orange side marker with rubber arm



2.43.150.80

Segnalatore braccio in gomma incolore - rosso - arancio
Clear - red - orange side marker with rubber arm



2.43.151.80

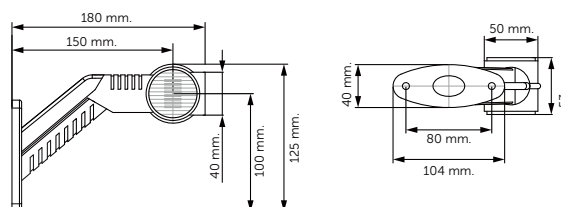

Segnalatore braccio in gomma incolore - rosso - arancio
Clear - red - orange side marker with rubber arm



2.43.152.80

Segnalatore braccio in gomma incolore - rosso - arancio
Clear - red - orange side marker with rubber arm



2.43.153.80

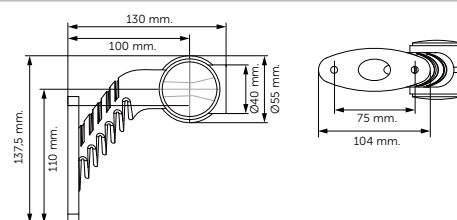

Segnalatore braccio in gomma incolore - rosso - arancio
Clear - red - orange side marker with rubber arm



2.43.154.80

Segnalatore braccio in gomma incolore - rosso - arancio
Clear - red - orange side marker with rubber arm



2.43.155.80

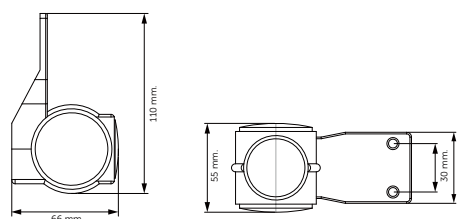

Segnalatore braccio in gomma incolore - rosso - arancio
Clear - red - orange side marker with rubber arm





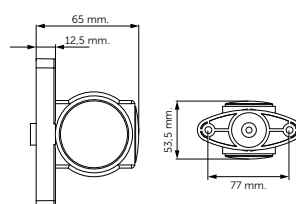



2.43.156.80

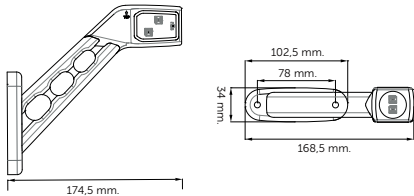

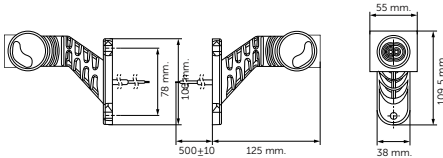

24V

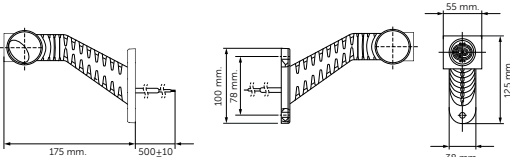

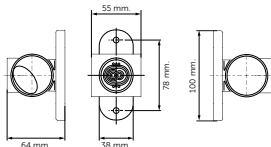
* Ricambio di qualità equivalente | Matching quality spare parts

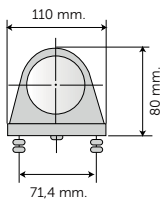



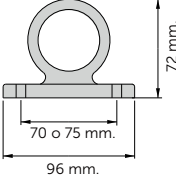

| UNIVERSALE | | LED | |
|--|--|-----|--------------------|
|  | Segnalatore ingombro <i>Side marker</i> | ➔ | 2.43.102.81 |
| | | ➔ | 2.43.103.81 |
|  | | | |
| 24V | | | |
| * Ricambio di qualità equivalente Matching quality spare parts | | | |

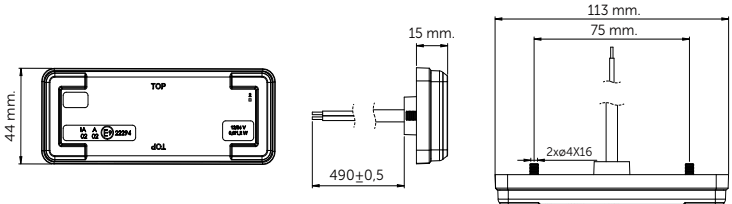





| UNIVERSALE | | LED | |
|--|--|-----|--------------------|
|  | Fanale ingombro incolore - arancio - rosso con cavo mm. 250 <i>Clear - red - orange side marker with cable 250 mm.</i> | ➔ | 2.43.234.80 |
| | Fanale ingombro incolore - arancio - rosso con cavo mm. 250 <i>Clear - red - orange side marker with cable 250 mm.</i> | ➔ | 2.43.235.80 |
|  | | | |
|  | Fanale ingombro incolore - arancio - rosso con cavo mm. 250 <i>Clear - red - orange side marker with cable 250 mm.</i> | ➔ | 2.43.236.80 |
| | Fanale ingombro incolore - arancio - rosso con cavo mm. 250 <i>Clear - red - orange side marker with cable 250 mm.</i> | ➔ | 2.43.237.80 |
|  | | | |
|  | Fanale ingombro incolore - arancio - rosso con cavo mm. 250 <i>Clear - red - orange side marker with cable 250 mm.</i> | ➔ | 2.43.232.80 |
| | | ➔ | |
|  | | | |
| 12-24V | | | |
| * Ricambio di qualità equivalente Matching quality spare parts | | | |

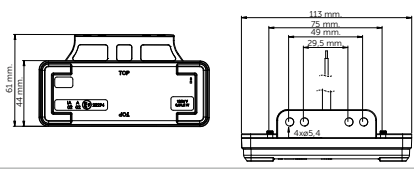
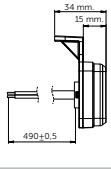

| UNIVERSALE | | LED | |
|--|---|-----|--|
|   | Fanale ingombro rosso - incolore braccio in gomma <i>Red - clear side marker with rubber arm</i> | ➔ | 2.43.086.81 |
| | Fanale ingombro rosso - incolore braccio in gomma <i>Red - clear side marker with rubber arm</i> | ➜ | 2.43.087.81 |
| | 3 led 12-24V | | * Ricambio di qualità equivalente Matching quality spare parts |

| UNIVERSALE | | LED | |
|---|---|-----|--|
|   | Fanale ingombro rosso - incolore braccio in gomma <i>Red - clear side marker with rubber arm</i> | ➔ | 2.43.084.81 |
| | Fanale ingombro rosso - incolore braccio in gomma <i>Red - clear side marker with rubber arm</i> | ➜ | 2.43.085.81 |
| | 3 led 12-24V | | * Ricambio di qualità equivalente Matching quality spare parts |

| UNIVERSALE | | LED | |
|---|---|--------|--------------------|
|    | Segnalatore ingombro incolore <i>Clear side marker</i> | ➔ ➜ | 2.43.342.80 |
| | Segnalatore ingombro arancio <i>Orange side marker</i> | ➔ ➜ | 2.43.344.80 |
| | Segnalatore ingombro rosso <i>Red side marker</i> | ➔ ➜ | 2.43.346.80 |
|  | | 12-24V | |
| * Ricambio di qualità equivalente Matching quality spare parts | | | |

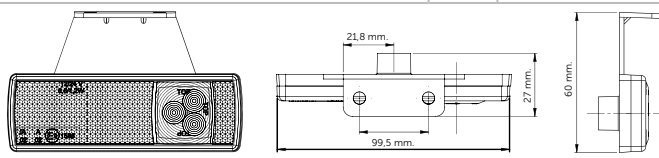
| UNIVERSALE | | LED | |
|---|--|--|--------------------|
|  | Segnalatore ingombro incolore con staffa <i>Clear side marker with bracket</i> |   | 2.43.348.80 |
| | Segnalatore ingombro arancio con staffa <i>Orange side marker with bracket</i> |   | 2.43.350.80 |
| | Segnalatore ingombro rosso con staffa <i>Red side marker with bracket</i> |   | 2.43.352.80 |
| 12-24V |  |  | |
| * Ricambio di qualità equivalente Matching quality spare parts | | | |

| UNIVERSALE | | LED | |
|--|--|---|--------------------|
|  | Segnalatore ingombro incolore con staffa <i>Clear side marker with bracket</i> |  | 2.43.354.80 |
| | |  | 2.43.355.80 |
| | Segnalatore ingombro arancio con staffa <i>Orange side marker with bracket</i> |  | 2.43.356.80 |
| | |  | 2.43.357.80 |
| | Segnalatore ingombro rosso con staffa <i>Red side marker with bracket</i> |  | 2.43.358.80 |
| | |  | 2.43.359.80 |
| 3 led 12-24V |  | | |
| * Ricambio di qualità equivalente Matching quality spare parts | | | |

| UNIVERSALE | | LED | |
|---|--|--|--------------------|
|  | Segnalatore ingombro incolore <i>Clear side marker</i> |   | 2.43.360.80 |
| | Segnalatore ingombro rosso <i>Red side marker</i> |   | 2.43.362.80 |
| 3 led 12-24V |  | | |
| * Ricambio di qualità equivalente Matching quality spare parts | | | |

UNIVERSALE

LED



Segnalatore ingombro incolore/rosso
Clear/red side marker

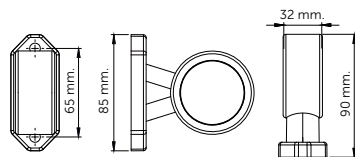

2.43.364.80



Segnalatore ingombro incolore/rosso
Clear/red side marker

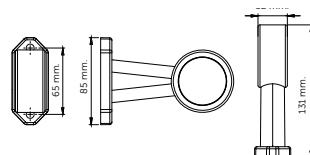

2.43.366.80



Segnalatore ingombro incolore/rosso
Clear/red side marker

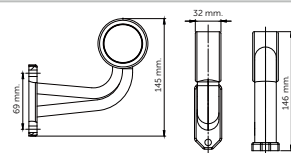

2.43.368.80



Segnalatore ingombro incolore/rosso
Clear/red side marker

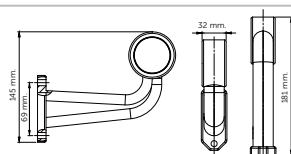

2.43.369.80



Segnalatore ingombro incolore/rosso
Clear/red side marker

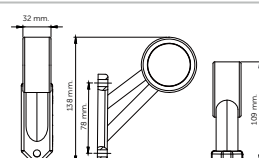

2.43.370.80



2.43.371.80



Segnalatore ingombro incolore/rosso
Clear/red side marker

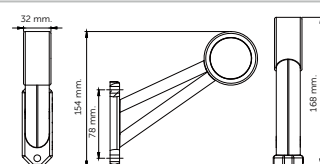

2.43.372.80



2.43.373.80



Refill incolore/rosso
Clear/red refill

2.43.374.80



2.43.375.80

2.43.376.25

* Ricambio di qualità equivalente | Matching quality spare parts

UNIVERSALE

LED



Segnalatore ingombro corto incolore/rosso
Clear/red side marker with short arm



2.43.378.80



2.43.379.80

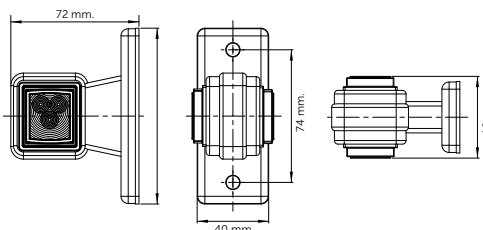

Segnalatore ingombro medio incolore/rosso
Clear/red side marker with medium arm



2.43.380.80



2.43.381.80

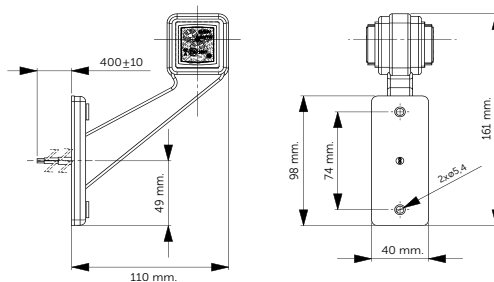

Segnalatore ingombro lungo incolore/rosso
Clear/red side marker with long arm



2.43.382.80



2.43.383.80

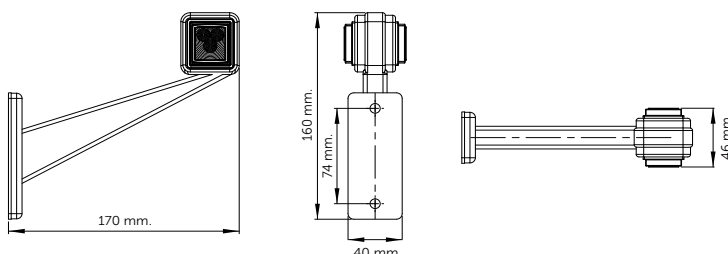

Refill quadrato incolore/rosso con cavo
Clear/red square refill with cable

2.43.377.25

3 led

*** Ricambio di qualità equivalente | Matching quality spare parts**

| UNIVERSALE | | LED |
|--|--|--|
| | Segnalatore ingombro incolore/arancio/rosso <i>Clear/orange/red side marker</i> | → 2.43.384.80 ← |
| | | |
| | Segnalatore ingombro incolore/arancio/rosso <i>Clear/orange/red side marker</i> | → 2.43.386.80 ← 2.43.387.80 |
| | | |
| | Segnalatore ingombro incolore/arancio/rosso <i>Clear/orange/red side marker</i> | → 2.43.388.80 ← 2.43.389.80 |
| | | |
| Segnalatore ingombro incolore/arancio/rosso <i>Clear/orange/red side marker</i> | → 2.43.390.80 ← 2.43.391.80 | |
| | | |
| * Ricambio di qualità equivalente Matching quality spare parts | | |

| UNIVERSALE | | LED |
|--|--|---------------------------|
| | Fanale ingombro incolore <i>Clear side marker</i> | → 2.43.262.80 ← |
| | Fanale ingombro arancio <i>Orange side marker</i> | → 2.43.263.80 ← |
| | Fanale ingombro rosso <i>Red side marker</i> | → 2.43.264.80 ← |
| | 12-24V | |
| * Ricambio di qualità equivalente Matching quality spare parts | | |

UNIVERSALE

 Staffa
 Bracket

2.42.076.17





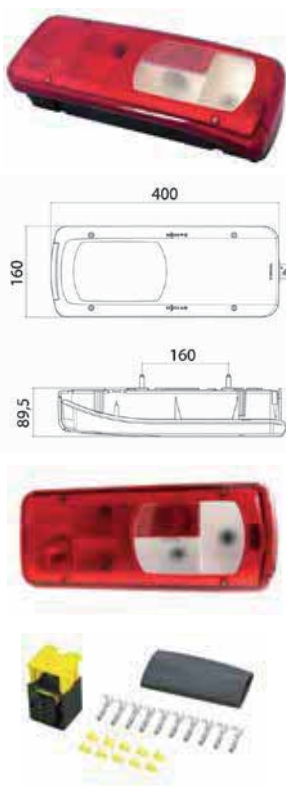

 Staffa
 Bracket

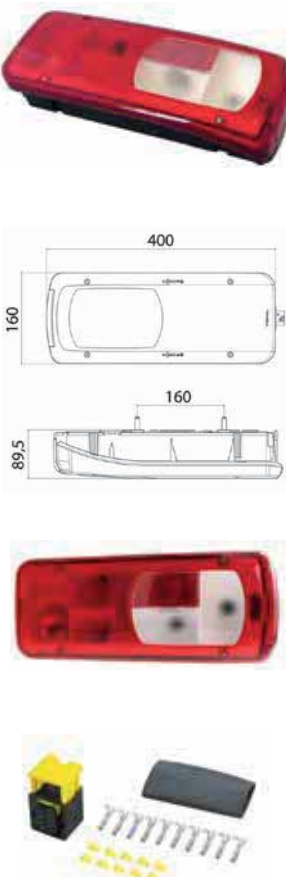

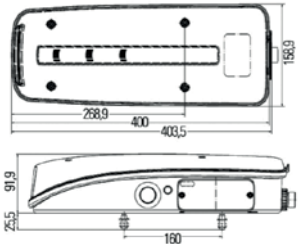



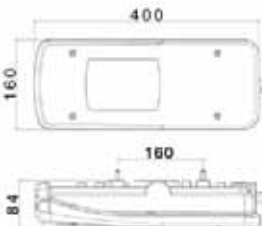

2.42.078.17

 * **Articolo universale | Universal part**

| DAF | CF XF LC8 | | |
|--|--|---|--------------------|
|  | Fanale posteriore <i>Rear lamp</i> | → | 5.44.090.00 |
| | Fanale posteriore con cicalino <i>Rear lamp with buzzer</i> | → | 5.44.090.70 |
| | Fanale posteriore con luce targa <i>Rear lamp with number plate light</i> | ← | 5.44.091.01 |
| | 12→ Trasparente posteriore <i>Rear lens</i> | → | 5.44.090.20 |
| | Trasparente posteriore <i>Rear lens</i> | → | 5.44.091.20 |
| | Connettore <i>Connector</i> | | 3.49.096.00 |
| | Attacco laterale HDSCS <i>Side connector HDSCS</i> | | |

| DAF | CF XF LC8 | | |
|---|--|---|--------------------|
|  | Fanale posteriore <i>Rear lamp</i> | → | 5.44.092.00 |
| | Fanale posteriore con cicalino <i>Rear lamp with buzzer</i> | → | 5.44.092.70 |
| | Fanale posteriore con luce targa <i>Rear lamp with number plate light</i> | ← | 5.44.093.01 |
| | 12→ Trasparente posteriore <i>Rear lens</i> | → | 5.44.090.20 |
| | Trasparente posteriore <i>Rear lens</i> | → | 5.44.091.20 |
| | Connettore <i>Connector</i> | | 3.49.096.00 |
| | Attacco posteriore HDSCS <i>Rear connector HDSCS</i> | | |

| DAF | CF - LF - XF 106 | LED | |
|---|--|---|--------------------|
|    | Fanale posteriore <i>Rear lamp</i> |  2.44.332.80 | |
| | Fanale posteriore con luce targa <i>Rear lamp with number plate light</i> |  2.44.333.81 | |
| | Trasparente posteriore <i>Rear lens</i> |  2.44.332.20 | |
| | Trasparente posteriore <i>Rear lens</i> |  2.44.333.20 | |
| | Funzioni <i>Functions</i> | 9 | |
| | Servizi <i>Services</i> | Direzione / Posizione / Stop / Retromarcia / Retronebbia / Catadiottro / Luce ingombro / Luce side marker / Indicatore direzione dinamico <i>Repeater / Parking / Stop / Reversing lamp / Rear fog lamp / Reflector / Side lamp / Side marker / Dynamic effect</i> | |
| | Fissaggio <i>Fixing</i> | 2 viti / 2 screws 8 pin | |
| | Connettore HDSC 8 vie laterali <i>8 side pins HDSC connector</i> | | 3.49.091.00 |
| | * Ricambio di qualità equivalente Matching quality spare parts | | |

| DAF | CF - XF - LC11 | LED | |
|--|--|--|---|
|     | Fanale posteriore <i>Rear lamp</i> |  5.44.094.80 | |
| | Fanale posteriore <i>Rear lamp</i> |  5.44.095.80 | |
| | Trasparente posteriore <i>Rear lens</i> |  5.44.094.20 | |
| | Trasparente posteriore <i>Rear lens</i> |  5.44.095.20 | |
| | Connettore <i>Connector</i> | | 3.49.096.00 |
| | Attacco laterale HDSCS <i>Side connector HDSCS</i> | |  |

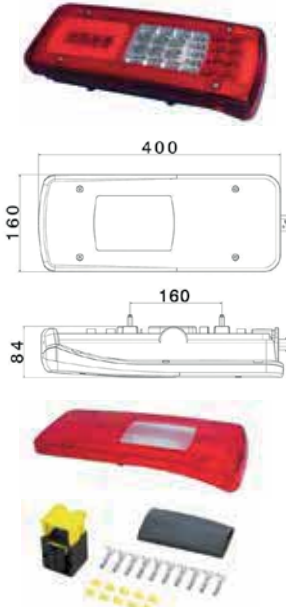
| DAF | | CF - XF - LC11 | | LED |
|---|-----|--|---|--------------------|
|  | 15→ | Fanale posteriore <i>Rear lamp</i> | → | 5.44.096.80 |
| | | Fanale posteriore <i>Rear lamp</i> | ← | 5.44.097.80 |
| | | Trasparente posteriore <i>Rear lens</i> | → | 5.44.094.20 |
| | | Trasparente posteriore <i>Rear lens</i> | ← | 5.44.095.20 |
| | | Connettore <i>Connector</i> | | 3.49.096.00 |
| | | Attacco posteriore HDSCS <i>Rear connector HDSCS</i> | | |

| FIAT-OM | | 616N2 625N2 650 662 | | |
|--|--|--|--------|--------------------|
|  | | Fanale posteriore <i>Rear lamp</i> | → ← | 2.44.232.00 |
| | | Trasparente posteriore <i>Rear lens</i> | → ← | 2.44.232.20 |
| * Ricambio di qualità equivalente <i>Matching quality spare parts</i> | | | | |

| FIAT OM | | LEONCINO DAINO | | |
|---|-----|---|--------|--------------------|
|  | 75→ | Trasparente posteriore <i>Rear lens</i> | → ← | 2.44.046.20 |
| | | * Ricambio di qualità equivalente <i>Matching quality spare parts</i> | | |

| FIAT | | DUCATO | | |
|---|-------|---------------------------------------|---|--------------------|
|  | 84→94 | Fanale posteriore <i>Rear lamp</i> | → | 2.44.110.00 |
| | | Fanale posteriore <i>Rear lamp</i> | ← | 2.44.111.00 |
| * Ricambio di qualità equivalente <i>Matching quality spare parts</i> | | | | |

FIAT/CITROËN/PEUGEOT
DUCATO | JUMPER | BOXER

94→01

 Fanale posteriore
Rear lamp

2.44.056.00

2.44.057.00

 Gruppo ottico posteriore
Rear optical unit

2.44.056.10

2.44.057.10

 Portalampane / *Bulb holder*
2.44.056.18

 * **Ricambio di qualità equivalente | Matching quality spare parts**
FIAT/CITROËN/PEUGEOT
DUCATO | JUMPER | BOXER

01→06

 Gruppo ottico posteriore
Rear optical unit

2.44.058.10

 Gruppo ottico posteriore
Rear optical unit

2.44.059.10

 * **Ricambio di qualità equivalente | Matching quality spare parts**
FIAT/CITROËN/PEUGEOT
DUCATO | JUMPER | BOXER



12→

 Fanale posteriore
Rear lamp

5.44.124.00

5.44.125.00

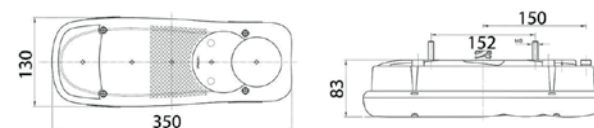
 Trasparente posteriore
Rear lens

5.44.098.20

4 perni / 4 pivots

FIAT/CITROËN/PEUGEOT
DUCATO | JUMPER | BOXER

06→

 Fanale posteriore
Rear lamp

5.44.068.00

5.44.069.00

 Gruppo ottico posteriore
Rear optical unit

2.44.206.10

2.44.207.10

 Cablaggio per fanale posteriore
Rear lamp wiring

5.44.068.19

5.44.069.19

| FIAT | | DUCATO | | |
|---|-------|--|---|--------------------|
|  | 94→01 | Fanale posteriore <i>Rear lamp</i> | → | 1.44.050.00 |
| | | | ← | 1.44.051.00 |
| | | Trasparente posteriore <i>Rear lens</i> | → | 1.44.050.20 |
| | | | ← | 1.44.051.20 |
| | | Connettore <i>Connector</i> | | 6.49.052.00 |
| | | Cablaggio <i>Wiring</i> | | 3.49.082.00 |

| FIAT | | DUCATO | | |
|--|-------|--|---|--------------------|
|  | 94→01 | Fanale posteriore <i>Rear lamp</i> | → | 2.44.228.00 |
| | | | ← | 2.44.229.00 |
| | | Trasparente posteriore <i>Rear lens</i> | → | 2.44.228.20 |
| | | | ← | 2.44.229.20 |
| * Ricambio di qualità equivalente Matching quality spare parts | | | | |

| FIAT | | DUCATO | | |
|---|-----|--|---|--------------------|
|  | 02→ | Fanale posteriore <i>Rear lamp</i> | → | 1.44.056.00 |
| | | | ← | 1.44.057.00 |
| | | Trasparente posteriore <i>Rear lens</i> | → | 1.44.050.20 |
| | | | ← | 1.44.051.20 |
| | | Connettore <i>Connector</i> | 1 | 3.49.058.00 |
| | | | 2 | 3.49.060.00 |

| FIAT | | DUCATO MY 2014 | | |
|---|-----|---------------------------------------|---|--------------------|
|  | 14→ | Fanale posteriore <i>Rear lamp</i> | → | 5.44.088.00 |
| | | Fanale posteriore <i>Rear lamp</i> | ← | 5.44.089.00 |

| FIAT | | DUCATO MY 2014 | | |
|---|-----|---|---|--------------------|
|  | 14→ | Gruppo ottico posteriore <i>Rear optical unit</i> | → | 2.44.272.10 |
| | | Gruppo ottico posteriore <i>Rear optical unit</i> | ← | 2.44.273.10 |
| | | * Ricambio di qualità equivalente Matching quality spare parts | | |

| FIAT | | DUCATO FURGONE | | |
|---|-------|--|--|--------------------|
|  | 01→06 | Fanale posteriore 3° stop <i>Additional stop lamp</i> | | 1.44.096.00 |
| | | | | |

| FIAT | | TALENTO | | |
|--|-----|--|---|--------------------|
|  | 15→ | Gruppo ottico posteriore <i>Rear optical unit</i> | → | 2.44.294.10 |
| | | Gruppo ottico posteriore <i>Rear optical unit</i> | ← | 2.44.295.10 |
| | | | | |

| FIAT | | TALENTO | | |
|---|--|---|---|--------------------|
|  | | Fanale posteriore retromarcia <i>Rear reverse lamp</i> | → | 1.44.106.00 |
| | | Fanale posteriore retronebbia <i>Rear fog lamp</i> | ← | 1.44.107.00 |
| | | | | |

| FIAT | | TALENTO UK | | |
|---|--|---|---|--------------------|
|  | | Fanale posteriore retronebbia <i>Rear fog lamp</i> | → | 1.44.104.00 |
| | | Fanale posteriore retromarcia <i>Rear reverse lamp</i> | ← | 1.44.105.00 |
| | | <i>Right hand traffic</i> | | |

| FORD | | CONNECT 2000 | |
|---|---|--|----------------------|
|  | 00→09 | Gruppo ottico posteriore <i>Rear optical unit</i> | ➔ 2.44.054.10 |
| | | Gruppo ottico posteriore <i>Rear optical unit</i> | ➜ 2.44.055.10 |
| | * Ricambio di qualità equivalente Matching quality spare parts | | |

| FORD | | CONNECT | |
|---|---|---------------------------------------|----------------------|
|  | 09→ | Fanale posteriore <i>Rear lamp</i> | ➔ 2.44.164.00 |
| | | Fanale posteriore <i>Rear lamp</i> | ➜ 2.44.165.00 |
| | * Ricambio di qualità equivalente Matching quality spare parts | | |



| FORD | | CONNECT | |
|---|---|---|----------------------|
|  | 13→ | Fanale posteriore parte superiore <i>Superior rear lamp</i> | ➔ 2.44.316.00 |
| | | Fanale posteriore parte superiore <i>Superior rear lamp</i> | ➜ 2.44.317.00 |
| | | Gruppo ottico posteriore inferiore <i>Inferior rear optical unit</i> | ➔ 2.44.314.10 |
| | | Gruppo ottico posteriore inferiore <i>Inferior rear optical unit</i> | ➜ 2.44.315.10 |
| | * Ricambio di qualità equivalente Matching quality spare parts | | |

| FORD | | COURIER | |
|---|---|--|----------------------|
|  | 14→ | Gruppo ottico posteriore <i>Rear optical unit</i> | ➔ 2.44.264.10 |
| | | Gruppo ottico posteriore <i>Rear optical unit</i> | ➜ 2.44.265.10 |
| | * Ricambio di qualità equivalente Matching quality spare parts | | |

| FORD | | TRANSIT MK V | | |
|---|---|---------------------------------------|---|--------------------|
|  | 95→01 | Fanale posteriore <i>Rear lamp</i> | → | 2.44.048.00 |
| | | Fanale posteriore <i>Rear lamp</i> | ← | 2.44.049.00 |
| | * Ricambio di qualità equivalente Matching quality spare parts | | | |

| FORD | | TRANSIT MK V | | |
|---|---|--|---|--------------------|
|  | 01→06 | Gruppo ottico posteriore <i>Rear optical unit</i> | → | 2.44.050.10 |
| | | Gruppo ottico posteriore <i>Rear optical unit</i> | ← | 2.44.051.10 |
| | * Ricambio di qualità equivalente Matching quality spare parts | | | |

| FORD | | TRANSIT MK VII | | |
|---|---|--|---|--------------------|
|  | 06→ | Gruppo ottico posteriore <i>Rear optical unit</i> | → | 2.44.052.10 |
| | | Gruppo ottico posteriore <i>Rear optical unit</i> | ← | 2.44.053.10 |
| | * Ricambio di qualità equivalente Matching quality spare parts | | | |

| FORD | | TRANSIT PICK-UP | | |
|---|---|---|--------|--------------------|
|    | 98→01 | Fanale posteriore 1 luce con connettore e cavo 480 mm. <i>Rear lamp</i> 1 light with connector and 480 mm. cable | → ← | 2.44.070.00 |
| | | Fanale posteriore 2 luci con passacavo <i>Rear lamp</i> 2 lights with fairlead | → ← | 2.44.040.00 |
| | | Trasparente posteriore <i>Rear lens</i> | → ← | 2.44.070.20 |
| | * Ricambio di qualità equivalente Matching quality spare parts | | | |

| FORD | | TRANSIT PICK-UP MK8 | |
|---|-----|--|----------------------|
|  | 14→ | Fanale posteriore <i>Rear lamp</i> | → 2.44.278.00 |
| | | Fanale posteriore <i>Rear lamp</i> | ← 2.44.279.00 |
| | | Trasparente posteriore <i>Rear lens</i> | → 2.44.278.10 |
| | | Trasparente posteriore <i>Rear lens</i> | ← 2.44.279.10 |
| * Ricambio di qualità equivalente Matching quality spare parts | | | |

| FORD | | TRANSIT | |
|--|-----|--|----------------------|
|  | 14→ | Gruppo ottico posteriore <i>Rear optical unit</i> | → 2.44.266.10 |
| | | Gruppo ottico posteriore <i>Rear optical unit</i> | ← 2.44.267.10 |
| * Ricambio di qualità equivalente Matching quality spare parts | | | |

| IVECO | | CITELIS | | LED | |
|---|-----|--|--|-----|--------------------|
|  | 10→ | Fanale posteriore stop / posizione <i>Stop / position rear lamp</i> | | | 4.44.098.80 |
| | | Fanale posteriore retronebbia <i>Rear fog lamp</i> | | | 4.44.100.80 |
| | | Fanale posteriore retromarcia <i>Reverse rear lamp</i> | | | 4.44.102.80 |
| | | Fanale posteriore stop posizione direzione - rosso/arancio <i>Red / orange - stop / position / repeater rear lamp</i> | | | 4.44.104.80 |

| IVECO | | DAILY 2000 | |
|---|-------|--|----------------------|
|  | 00→06 | Fanale posteriore stop / posizione <i>Stop / position rear lamp</i> | → 2.44.060.00 |
| | | | ← 2.44.061.00 |
| | | Gruppo ottico posteriore <i>Rear optical unit</i> | → 2.44.060.10 |
| | | | ← 2.44.061.10 |
| * Ricambio di qualità equivalente Matching quality spare parts | | | |

| IVECO | | DAILY 2000 | |
|---|-------|--|--------------------|
|  | 00→06 | Fanale posteriore 3° stop <i>Additional stop lamp</i> | 1.44.098.00 |
| | | | |

| IVECO | | DAILY | |
|---|---|--|----------------------|
|  | 07→14 | Gruppo ottico posteriore <i>Rear optical unit</i> | ➔ 2.44.072.10 |
| | | Gruppo ottico posteriore <i>Rear optical unit</i> | ➜ 2.44.073.10 |
| | * Ricambio di qualità equivalente Matching quality spare parts | | |

| IVECO | | DAILY 2014 | |
|---|-----|---|----------------------|
|  | 14→ | Fanale posteriore con retronebbia - retromarcia <i>Rear reverse - fog lamp</i> | ➔ 5.44.080.00 |
| | | Fanale posteriore con retronebbia - retromarcia <i>Rear reverse - fog lamp</i> | ➜ 5.44.081.00 |
| | | Gruppo ottico posteriore <i>Rear optical unit</i> | ➔ 2.44.220.10 |
| | | Gruppo ottico posteriore <i>Rear optical unit</i> | ➜ 2.44.221.10 |

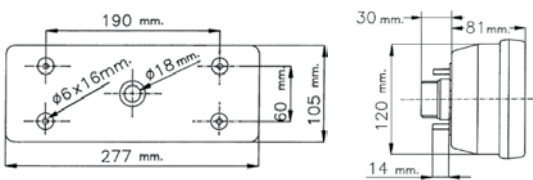

| IVECO | | DAILY EUROCARGO STRALIS | | LED | |
|---|-----|--|--|-----|--------------------|
|  | 14→ | Fanale posteriore 3° stop (base) <i>Additional stop light (base)</i> | | | 5.44.084.00 |
| | | Fanale posteriore 3° stop (medio) <i>Additional stop light (middle)</i> | | | 5.44.086.00 |

| IVECO | | DAILY | |
|---|-------|--|----------------------|
|  | 84→01 | Fanale posteriore <i>Rear lamp</i> | → 1.44.050.00 |
| | | Fanale posteriore <i>Rear lamp</i> | ← 1.44.051.00 |
| | | Trasparente posteriore <i>Rear lens</i> | → 1.44.050.20 |
| | | Trasparente posteriore <i>Rear lens</i> | ← 1.44.051.20 |
| | | Connettore <i>Connector</i> | 6.49.052.00 |
| | | Cablaggio <i>Wirings</i> | 3.49.082.00 |

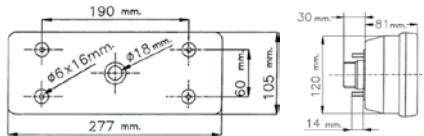

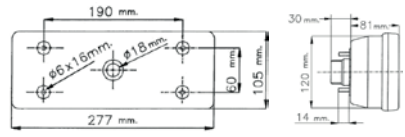

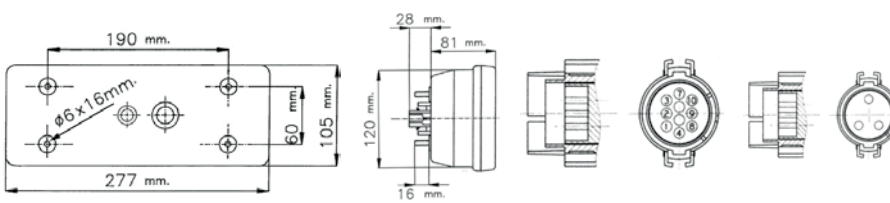

| IVECO | | DAILY S. | |
|--|---|--|----------------------|
|  | 99→06 | Fanale posteriore <i>Rear lamp</i> | → 1.44.058.00 |
| | | Fanale posteriore <i>Rear lamp</i> | ← 1.44.059.00 |
| | | Trasparente posteriore <i>Rear lens</i> | → 1.44.058.20 |
| | | Trasparente posteriore <i>Rear lens</i> | ← 1.44.059.20 |
| | | Funzioni <i>Functions</i> | 5 |
| Servizi <i>Services</i> | Direzione / Posizione / Stop / Retronebbia / Retromarcia / Catadiottro <i>Repeater / Parking / Stop / Reversing lamp / Rear fog lamp / Reflector</i> | | |
| Fissaggio <i>Fixing</i> | 4 perni / 4 pivots | | |
| Lampade <i>Bulbs</i> | 3 x P21W - 2 x R5W | | |
| |  | | |
| | Connettore <i>Connector</i> | | 3.49.070.00 |



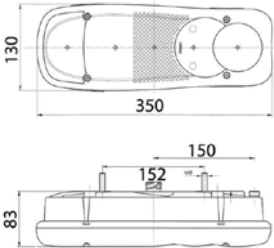



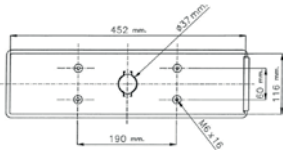

| IVECO | | DAILY S. UK | | |
|--|---|---------------------------------------|---|--|
|  | | Fanale posteriore <i>Rear lamp</i> | ➔ 1.44.058.00UK | |
| | | Fanale posteriore <i>Rear lamp</i> | ➜ 1.44.059.00UK | |
| | 99→06 | Funzioni <i>Functions</i> | 5 | |
| | | Servizi <i>Services</i> | Direzione / Posizione / Stop / Retronebbia / Retromarcia / Catadiottro <i>Repeater / Parking / Stop / Reversing lamp / Rear fog lamp / Reflector</i> | |
| | | Fissaggio <i>Fixing</i> | 4 perni / 4 pivots | |
| | | Lampade <i>Bulbs</i> | 3 x P21W - 2 x R5W | |
| |  | | | |
| | Connettore <i>Connector</i> | | 3.49.070.00 | |
| | <i>Right hand traffic</i> | | | |

| IVECO | | DAILY S. 2000 | | |
|---|---|--|---|----------------------|
|  | | Fanale posteriore <i>Rear lamp</i> | ➔ 2.44.064.00 | |
| | | Fanale posteriore <i>Rear lamp</i> | ➜ 2.44.065.00 | |
| | | Trasparente posteriore <i>Rear lens</i> | | ➔ 2.44.064.20 |
| | | | | ➜ 2.44.065.20 |
| | 06→ | Funzioni <i>Functions</i> | 5 | |
| | | Servizi <i>Services</i> | Direzione / Posizione / Stop / Retronebbia / Retromarcia / Catadiottro <i>Repeater / Parking / Stop / Reversing lamp / Rear fog lamp / Reflector</i> | |
| Fissaggio <i>Fixing</i> | | 4 perni / 4 pivots | | |
| Lampade <i>Bulbs</i> | | 3 x P21W - 2 x R5W | | |
| |  | | | |
| | Connettore <i>Connector</i> | | 3.49.070.00 | |
| | * Ricambio di qualità equivalente Matching quality spare parts | | | |





| IVECO | | EUROCARGO | |
|---|--|---|----------------------|
|  | | Fanale posteriore <i>Rear lamp</i> | ➔ 1.44.056.00 |
| | | Fanale posteriore <i>Rear lamp</i> | ➜ 1.44.057.00 |
| | | Trasparente posteriore <i>Rear lens</i> | ➔ 1.44.050.20 |
| | | Trasparente posteriore <i>Rear lens</i> | ➜ 1.44.051.20 |
| | 91→03 | Funzioni <i>Functions</i> | 5 |
| | Servizi <i>Services</i> | Direzione / Posizione / Stop / Retronebbia / Retromarcia / Catadiottro <i>Repeater / Parking / Stop / Reversing lamp / Rear fog lamp / Reflector</i> | |
| | Fissaggio <i>Fixing</i> | 4 perni / 4 pivots | |
| | Lampade <i>Bulbs</i> | 3 x P21W - 2 x R5W | |
| |  | | |
| | | Connettore 10 vie / 10 ways connector | 1 3.49.058.00 |
| | | Connettore 3 vie / 3 ways connector | 2 3.49.060.00 |
| |  | | |

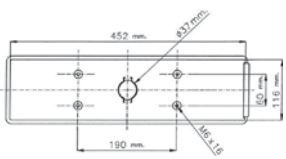

| IVECO | | EUROCARGO UK | |
|---|-------|--|----------------------|
|  | 91→03 | Trasparente posteriore <i>Rear lens</i> | ➔ 1.44.050.28 |
| | | Trasparente posteriore <i>Rear lens</i> | ➜ 1.44.051.29 |
| | | <i>Right hand traffic</i> | |





| IVECO | | EUROCARGO | | | |
|--|-----|--|--|--------------------|---|
|    | 11→ | Fanale posteriore <i>Rear lamp</i> |  5.44.098.00  5.44.099.00 | | |
| | | Fanale posteriore con cicalino <i>Rear lamp with buzzer</i> |  5.44.098.70 | | |
| | | Trasparente posteriore <i>Rear lens</i> |  5.44.098.20  | | |
| | | Funzioni <i>Functions</i> | 6 | | |
| | | Servizi <i>Services</i> | Direzione / Posizione / Stop / Retronebbia / Retromarcia / Catadiottro <i>Repeater / Parking / Stop / Reversing lamp / Rear fog lamp / Reflector</i> | | |
| | | Fissaggio <i>Fixing</i> | 2 perni / 2 pivots 6 pin | | |
| | | Lampade <i>Bulbs</i> | 4 x P21W - 3 x R5W | | |
| | | Connettore <i>Connector</i> | | 3.49.070.00 | |
| | | | | |  |

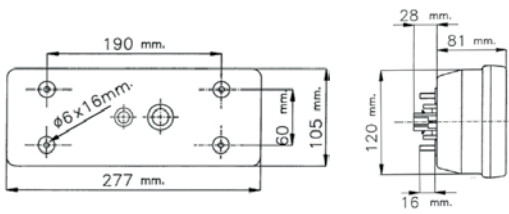

| IVECO | | EUROCARGO STRALIS | | |
|---|-----|---|--|--------------------|
|    | 96→ | Fanale posteriore <i>Rear lamp</i> |  1.44.064.00  1.44.065.00 | |
| | | Fanale posteriore con luce targa <i>Rear lamp with number plate light</i> |  1.44.066.01  1.44.067.01 | |
| | | Trasparente posteriore <i>Rear lens</i> |  1.44.064.21  | |
| | | Trasparente posteriore senza catadiottro <i>Rear lens without reflex reflector</i> | 1.44.070.22 | |
| | | Funzioni <i>Functions</i> | 7 | |
| | | Servizi <i>Services</i> | Direzione / Posizione / Stop / Retromarcia / Retronebbia / Catadiottro <i>Repeater / Parking / Stop / Reversing lamp / Rear fog lamp / Reflector</i> | |
| | | Fissaggio <i>Fixing</i> | 4 perni / 4 pivots | |
| | | Connettore <i>Connector</i> | | 3.49.058.00 |

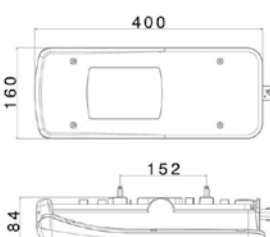
| IVECO | | EUROCARGO - STRALIS | |
|--|---|--|---|
|   | 96→ | Fanale posteriore <i>Rear lamp</i> | → 2.44.138.00 |
| | | Fanale posteriore con luce targa <i>Rear lamp with number plate light</i> | ← 2.44.139.01 |
| | | Trasparente posteriore <i>Rear lens</i> | → ← 1.44.064.21 |
| | | Funzioni <i>Functions</i> | 7 |
| | | Servizi <i>Services</i> | Direzione / Posizione / Stop / Retronebbia / Retromarcia / Catadiottro <i>Repeater / Parking / Stop / Reversing lamp / Rear fog lamp / Reflector</i> |
| | | Fissaggio <i>Fixing</i> | 4 perni / 4 pivots |
| | * Ricambio di qualità equivalente Matching quality spare parts | | |



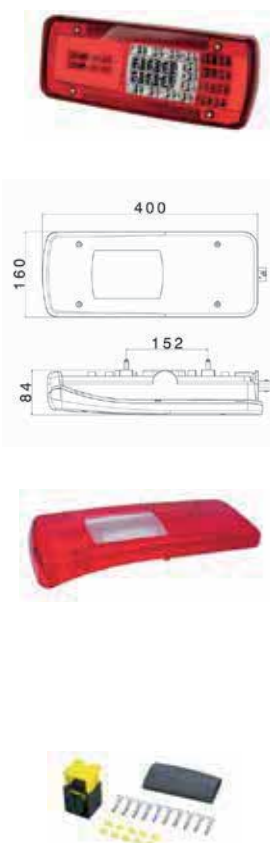

| IVECO | | EUROCARGO STRALIS EURO 6 | |
|--|----------------------------|---|----------------------|
|     | 12→ | Fanale posteriore <i>Rear lamp</i> | → 1.44.100.00 |
| | | Fanale posteriore <i>Rear lamp</i> | → 1.44.101.00 |
| | | Fanale posteriore con cicalino <i>Rear lamp with buzzer</i> | ← 1.44.102.70 |
| | | Fanale posteriore con luce targa <i>Rear lamp with number plate light</i> | → 1.44.103.01 |
| | | Trasparente posteriore <i>Rear lens</i> | → 1.44.064.21 |
| | | Funzioni <i>Functions</i> | 7 |
| | Servizi <i>Services</i> | Direzione / Posizione / Stop / Retromarcia / Retronebbia / Catadiottro <i>Repeater / Parking / Stop / Reversing lamp / Rear fog lamp / Reflector</i> | |
| Fissaggio <i>Fixing</i> | 4 perni / 4 pivots | | |
| Connettore <i>Connector</i> | | | 3.49.090.00 |
| Attacco DIN tondo piccolo <i>Small round DIN connector</i> | | | |





| IVECO | | EUROTECH | |
|--|-----|---|---|
|   | 93→ | Fanale posteriore <i>Rear lamp</i> | ➔ 1.44.060.00 |
| | | Fanale posteriore <i>Rear lamp</i> | ➤ 1.44.061.00 |
| | | Fanale posteriore con luce targa <i>Rear lamp with number plate light</i> | ➔ 1.44.063.01 |
| | | Trasparente posteriore <i>Rear lens</i> | ➔ 1.44.052.20 |
| | | Trasparente posteriore <i>Rear lens</i> | ➤ 1.44.053.20 |
| | | Funzioni <i>Functions</i> | 6 |
| | | Servizi <i>Services</i> | Direzione / Posizione / Stop / Retronebbia / Retromarcia / Catadiottro <i>Repeater / Parking / Stop / Reversing lamp / Rear fog lamp / Reflector</i> |
| | | Fissaggio <i>Fixing</i> | 4 perni / 4 pivots |
| | | Lampade <i>Bulbs</i> | 5 x P21W - 2 x R5W |
| | |  | |
| Connettore 10 vie / <i>10 ways connector</i> | | 1 | 3.49.058.00 |
| Connettore 3 vie / <i>3 ways connector</i> | | 2 | 3.49.060.00 |

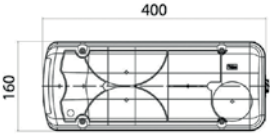
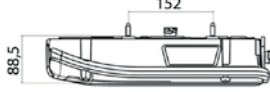

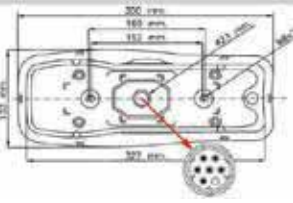

| IVECO | | STRALIS LC11 | | LED | |
|--|-----|--|---|---|--|
|     | 16→ | Fanale posteriore <i>Rear lamp</i> | ➔ 5.44.100.80 | | |
| | | Fanale posteriore <i>Rear lamp</i> | ➤ 5.44.101.80 | | |
| | | Fanale posteriore con cicalino <i>Rear lamp with buzzer</i> | ➔ 5.44.100.78 | | |
| | | Fanale posteriore con luce targa <i>Rear lamp with number plate light</i> | ➤ 5.44.101.81 | | |
| | | Trasparente posteriore <i>Rear lens</i> | ➔ 5.44.100.20 | | |
| | | Trasparente posteriore <i>Rear lens</i> | ➤ 5.44.101.20 | | |
| | | Funzioni <i>Functions</i> | 7 | | |
| | | Servizi <i>Services</i> | Direzione / Posizione / Stop / Retromarcia / Retronebbia / Catadiottro <i>Repeater / Parking / Stop / Reversing lamp / Rear fog lamp / Reflector</i> | | |
| | | Fissaggio <i>Fixing</i> | 2 perni / 2 pivots | | |
| | | Connettore <i>Connector</i> | | | |
| Attacco laterale HDSCS <i>Side connector HDSCS</i> | | | |  | |



| IVECO | | STRALIS TRAKKER LC11 | | LED | |
|---|-----|--|---|---|--------------------|
|  <p>Technical drawings showing dimensions: 400 (width), 160 (height), 152 (width of lens), 84 (height of lens).</p> | 16→ | Fanale posteriore <i>Rear lamp</i> | → | 5.44.102.80 | |
| | | Fanale posteriore <i>Rear lamp</i> | ← | 5.44.103.80 | |
| | | Fanale posteriore con cicalino <i>Rear lamp with buzzer</i> | → | 5.44.102.78 | |
| | | Fanale posteriore con luce targa <i>Rear lamp with number plate light</i> | ← | 5.44.103.81 | |
| | | Trasparente posteriore <i>Rear lens</i> | → | 5.44.100.20 | |
| | | Trasparente posteriore <i>Rear lens</i> | ← | 5.44.101.20 | |
| | | Funzioni <i>Functions</i> | 7 | | |
| | | Servizi <i>Services</i> | Direzione / Posizione / Stop / Retromarcia / Retronebbia / Catadiottro <i>Repeater / Parking / Stop / Reversing lamp / Rear fog lamp / Reflector</i> | | |
| | | Fissaggio <i>Fixing</i> | 2 perni / 2 pivots | | |
| | | Connettore <i>Connector</i> | | | 3.49.096.00 |
| Attacco posteriore HDSCS <i>Rear connector HDSCS</i> | | | |  | |

| IVECO | | STRALIS TRAKKER LC8 | | | |
|--|-----|--|---|--------------------|--------------------|
|  <p>Technical drawings showing dimensions: 400 (width), 160 (height), 152 (width of lens), 88.5 (height of lens).</p> | 16→ | Fanale posteriore <i>Rear lamp</i> | → | 5.44.104.00 | |
| | | Fanale posteriore con cicalino <i>Rear lamp with buzzer</i> | → | 5.44.104.70 | |
| | | Fanale posteriore con luce targa <i>Rear lamp with number plate light</i> | ← | 5.44.105.01 | |
| | | Trasparente posteriore <i>Rear lens</i> | → | 5.44.104.20 | |
| | | Trasparente posteriore <i>Rear lens</i> | ← | 5.44.105.20 | |
| | | Funzioni <i>Functions</i> | 7 | | |
| | | Servizi <i>Services</i> | Direzione / Posizione / Stop / Retromarcia / Retronebbia / Catadiottro <i>Repeater / Parking / Stop / Reversing lamp / Rear fog lamp / Reflector</i> | | |
| | | Fissaggio <i>Fixing</i> | 2 perni / 2 pivots | | |
| | | Connettore <i>Connector</i> | | | 3.49.096.00 |
| | | Attacco laterale HDSCS <i>Side connector HDSCS</i> | | | |

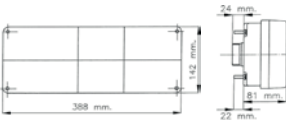

| IVECO | | STRALIS TRAKKER EURO 6 LC8 | |
|--|-----|--|---|
|       | 16→ | Fanale posteriore fumè <i>Fumè rear lamp</i> | → 5.44.106.00 |
| | | Fanale posteriore fumè <i>Fumè rear lamp</i> | ← 5.44.107.00 |
| | | Fanale posteriore con cicalino <i>Rear lamp with buzzer</i> | → 5.44.106.70 |
| | | Fanale posteriore fumè con luce targa <i>Fumè rear lamp with number plate light</i> | → 5.44.107.01 |
| | | Trasparente posteriore <i>Rear lens</i> | → 5.44.104.20 ← 5.44.105.20 |
| | | Funzioni <i>Functions</i> | 7 |
| | | Servizi <i>Services</i> | Direzione / Posizione / Stop / Retromarcia / Retronebbia / Catadiottro <i>Repeater / Parking / Stop / Reversing lamp / Rear fog lamp / Reflector</i> |
| | | Fissaggio <i>Fixing</i> | 2 perni / 2 pivots |
| | | Connettore <i>Connector</i> | 3.49.096.00 |
| | | Attacco posteriore HDSCS <i>Rear connector HDSCS</i> | |





| IVECO | | STRALIS TRAKKER LC5 | | | |
|---|-----|--|---|---|--|
|     | 16→ | Fanale posteriore <i>Rear lamp</i> | → 5.44.098.00 ← 5.44.099.00 | | |
| | | Fanale posteriore con cicalino <i>Rear lamp with buzzer</i> | → 5.44.098.70 | | |
| | | Trasparente posteriore <i>Rear lens</i> | → 5.44.098.20 ← 5.44.098.20 | | |
| | | Funzioni <i>Functions</i> | 6 | | |
| | | Servizi <i>Services</i> | Direzione / Posizione / Stop / Retromarcia / Retronebbia / Catadiottro <i>Repeater / Parking / Stop / Reversing lamp / Rear fog lamp / Reflector</i> | | |
| | | Fissaggio <i>Fixing</i> | 2 perni / 2 pivots 6 pin | | |
| | | Lampade <i>Bulbs</i> | 4 x P21W - 3 x R5W | | |
| | | Connettore <i>Connector</i> | 3.49.070.00 | | |
| | | | |  | |

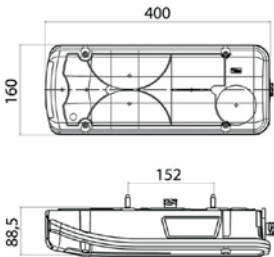

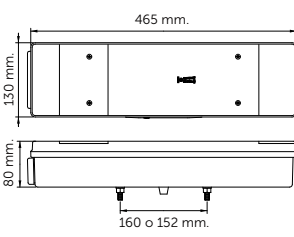

| IVECO | | TURBOSTAR | |
|--|-----|--|---|
|      | 83→ | Fanale posteriore <i>Rear lamp</i> | → 1.44.052.00 |
| | | Fanale posteriore <i>Rear lamp</i> | ← 1.44.053.00 |
| | | Fanale posteriore con luce targa <i>Rear lamp with number plate light</i> | 1.44.055.01 |
| | | Trasparente posteriore <i>Rear lens</i> | → 1.44.052.20 |
| | | Trasparente posteriore <i>Rear lens</i> | ← 1.44.053.20 |
| | | Funzioni <i>Functions</i> | 6 |
| | | Servizi <i>Services</i> | Direzione / Posizione / Stop / Retromarcia / Retronebbia / Catadiottro <i>Repeater / Parking / Stop / Reversing lamp / Rear fog lamp / Reflector</i> |
| | | Fissaggio <i>Fixing</i> | 4 perni / 4 pivots |
| | | Lampade <i>Bulbs</i> | 5 x P21W - 2 x R5W |
| | | Raccordo con ghiera mm. 45x15 <i>Nipple with plastic ring mm. 45x15</i> | 6.49.055.00 |

| KRONE | | RIMORCHI TRAILERS | |
|---|-----|---|----------------------|
|   | 11→ | Fanale posteriore con catadiottro triangolare <i>Rear lamp with triangular reflex-reflector</i> | → 2.44.216.00 |
| | | Fanale posteriore con catadiottro triangolare <i>Rear lamp with triangular reflex-reflector</i> | ← 2.44.217.00 |
| | | Trasparente posteriore con catadiottro triangolare <i>Rear lens with triangular reflex reflector</i> | → 2.44.216.20 |
| | | Trasparente posteriore con catadiottro triangolare <i>Rear lens with triangular reflex reflector</i> | ← 2.44.217.20 |
| | | Funzioni / <i>Functions</i> | 7 |
| | | Fissaggio / <i>Fixing</i> | 2 perni / 2 pivots |
| * Ricambio di qualità equivalente Matching quality spare parts | | | |

| KRONE | | RIMORCHI <i>TRAILERS</i> | | |
|---|--------------------------------|---|----------------------|--|
|  | 11→ | Fanale posteriore con catadiottro triangolare <i>Rear lamp with triangular reflex reflector</i> | → 2.44.218.00 | |
| | | Fanale posteriore con catadiottro triangolare <i>Rear lamp with triangular reflex-reflector</i> | ← 2.44.219.00 | |
| | | Trasparente posteriore con catadiottro triangolare <i>Rear lens with triangular reflex reflector</i> | → 2.44.216.20 | |
| | | Trasparente posteriore con catadiottro triangolare <i>Rear lens with triangular reflex reflector</i> | ← 2.44.217.20 | |
| | Funzioni / <i>Functions</i> | 7 | | |
| | Fissaggio / <i>Fixing</i> | 2 perni / 2 <i>pivots</i> | | |
| * Ricambio di qualità equivalente Matching quality spare parts | | | | |

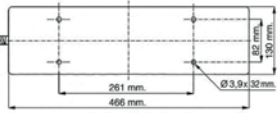
| MAN-DAF | | TGA - TGL - TGM | | |
|---|--------------------------------|--|----------------------|--|
|    | 96→ | Fanale posteriore <i>Rear lamp</i> | → 5.44.060.00 | |
| | | Fanale posteriore con luce targa <i>Rear lamp with number plate light</i> | ← 5.44.061.00 | |
| | | Trasparente posteriore <i>Rear lens</i> | → 5.44.060.20 | |
| | | Trasparente posteriore <i>Rear lens</i> | ← 5.44.061.20 | |
| | Funzioni / <i>Functions</i> | 7 | | |
| | Servizi / <i>Services</i> | Direzione / Posizione / Stop / Retromarcia / Retronebbia / Ingombro arancio <i>Repeater / Parking / Stop / Reversing lamp / Rear fog lamp / Orange side marker</i> | | |
| | Fissaggio / <i>Fixing</i> | 2 perni / 2 <i>pivots</i> | | |
| | Lampade / <i>Bulbs</i> | 5 x P21W - 2 x R5W | | |
| Connettore <i>Connector</i> | | | 3.49.070.00 | |
|  | | | | |

| MAN-DAF | | F 2000 | |
|--|-------|-------------------------------------|--|
|   | 06→11 | Fanale posteriore Rear lamp |  2.44.176.00 |
| | | Fanale posteriore Rear lamp |  2.44.177.01 |
| | | Trasparente posteriore Rear lens |   2.44.174.20 |
| | | Funzioni Functions | 7 |
| | | Servizi Services | Direzione / Posizione / Stop / Retromarcia / Retronebbia / Ingombro arancio Repeater / Parking / Stop / Reversing lamp / Rear fog lamp / Side marker |
| | | Fissaggio Fixing | 2 perni / 2 pivots 6 Pin attacco laterale / 6 Pin side fitting |
| | | Lampade Bulbs | 4 x P21W - 3 x R5W |
| * Ricambio di qualità equivalente Matching quality spare parts | | | |

| MAN-DAF | | F 2000 LC7 | |
|--|--------------------|--------------------------------|--|
|   | 06→11 | Fanale posteriore Rear lamp |  4.44.084.01 |
| | | Fanale posteriore Rear lamp |  4.44.085.01 |
| | | Funzioni Functions | 7 |
| | | Servizi Services | Direzione / Posizione / Stop / Retromarcia / Retronebbia / Side marker Repeater / Parking / Stop / Reversing lamp / Rear fog lamp / Side marker |
| | | Fissaggio Fixing | 2 perni / 2 pivots 6 Pin attacco laterale / 6 Pin side fitting |
| Lampade Bulbs | 4 x P21W - 3 x R5W | | |
|  | | | |

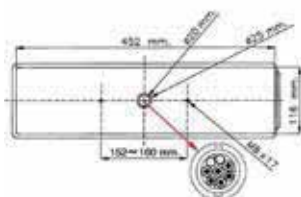
MAN-DAF
F 2000

06→11

 Fanale posteriore
Rear lamp

2.44.120.00

2.44.121.00

 Fanale posteriore con luce targa
Rear lamp with number plate light

2.44.123.01

 Trasparente posteriore
Rear lens

2.44.174.20

 Funzioni
Functions

7

 Servizi
Services

 Direzione / Posizione / Stop / Retromarcia / Retronebbia / Side marker
Repeater / Parking / Stop / Reversing lamp / Rear fog lamp / Side marker

 Fissaggio
Fixing

 2 perni / 2 pivots
 6 Pin attacco laterale / 6 Pin side fitting

 Lampade
Bulbs

4 x P21W - 3 x R5W

Connettore | Connector

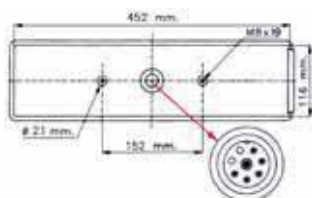
3.49.090.00
*** Ricambio di qualità equivalente | Matching quality spare parts**
MAN / DAF
FM-FL LC7

 Fanale posteriore
Rear lamp

4.44.070.00

4.44.071.00

 Fanale posteriore con luce targa
Rear lamp with number plate light

4.44.071.01

 Trasparente posteriore
Rear lens

2.44.174.20

 Funzioni
Functions

7

 Servizi
Services

 Direzione / Posizione / Stop / Retromarcia / Retronebbia / Catadiottro
Repeater / Parking / Stop / Reversing lamp / Rear fog lamp / Reflector

 Fissaggio
Fixing

 2 perni / 2 pivots
 6 Pin attacco laterale / 6 Pin side fitting

 Lampade
Bulbs

4 x P21W - 3 x R5W

Connettore | Connector

3.49.070.00

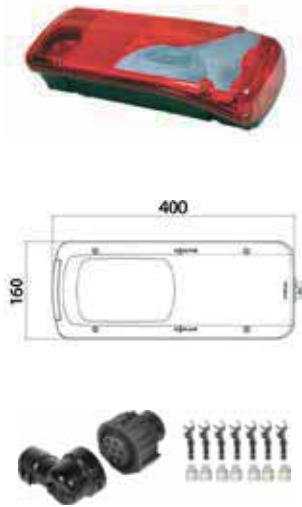
| MAN | | TGE LC8 | |
|--|-----|--|----------------------|
|  <p>400 160</p> | 17→ | Fanale posteriore <i>Rear lamp</i> | → 5.44.116.00 |
| | | Fanale posteriore <i>Rear lamp</i> | ← 5.44.117.00 |
| | | Trasparente posteriore <i>Rear lens</i> | → 5.44.060.20 |
| | | Trasparente posteriore <i>Rear lens</i> | ← 5.44.061.20 |
| | | Connettore <i>Connector</i> | 3.49.070.00 |
| | | Attacco posteriore AMP 1.5 <i>Rear connector AMP 1.5</i> | |

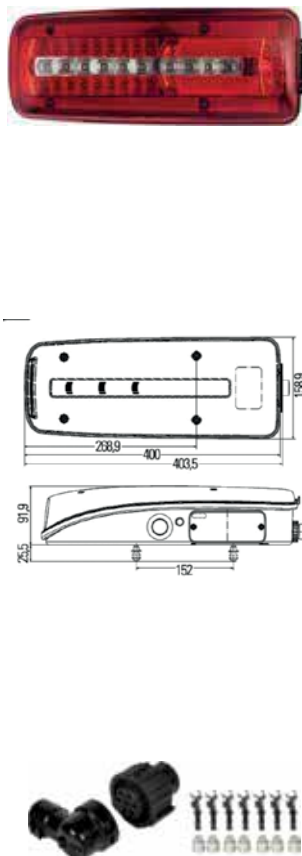
| MAN | | TGS | LED | |
|--|----------------------------|--|---|--|
|  <p>208.9 400 403.5 138.9 25.5 91.9 152</p> | 12→ | Fanale posteriore <i>Rear lamp</i> | → 2.44.334.80 | |
| | | Fanale posteriore con luce targa <i>Rear lamp with number plate light</i> | ← 2.44.335.81 | |
| | | Trasparente posteriore <i>Rear lens</i> | → 2.44.334.20 | |
| | | Trasparente posteriore <i>Rear lens</i> | ← 2.44.335.20 | |
| | | Funzioni <i>Functions</i> | 8 | |
| | | Servizi <i>Services</i> | Direzione / Posizione / Stop / Retromarcia / Retronebbia / Catadiottro / Luce ingombro / Luce side marker <i>Repeater / Parking / Stop / Reversing lamp / Rear fog lamp / Reflector / Side lamp / Side marker</i> | |
| Fissaggio <i>Fixing</i> | 2 viti / 2 screws 7 pin | | | |
| Connettore <i>Connector</i> | | | 3.49.070.00 | |
| * Ricambio di qualità equivalente Matching quality spare parts | | | | |

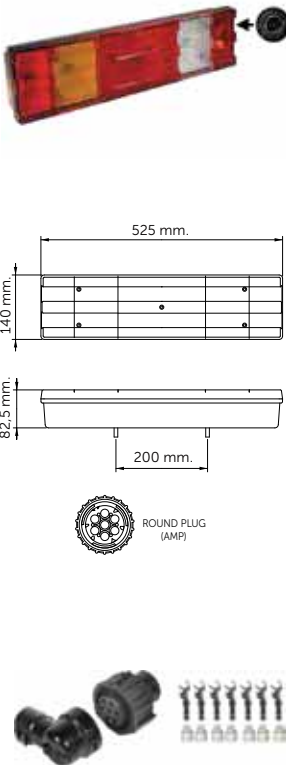
| MERCEDES | | ACTROS | |
|---|-------|--|--|
|  <p>525 mm.</p> <p>140 mm.</p> <p>82,5 mm.</p> <p>200 mm.</p> <p>ROUND PLUG (AMP)</p> | 96→02 | Fanale posteriore <i>Rear lamp</i> | → 2.44.078.00 |
| | | | ← 2.44.079.00 |
| | | Fanale posteriore con luce targa <i>Rear lamp with number plate light</i> | ← 2.44.081.01 |
| | | | ← 2.44.079.01 |
| | | Trasparente posteriore <i>Rear lens</i> | → 2.44.078.20 |
| | | | ← 2.44.079.20 |
| | | Funzioni <i>Functions</i> | 7 |
| | | Servizi <i>Services</i> | Direzione / Posizione / Stop / Retromarcia / Retronebbia / Catadiottero <i>Repeater / Parking / Stop / Reversing lamp / Rear fog lamp / Reflector</i> |
| | | Fissaggio <i>Fixing</i> | 2 perni / 2 pivots 6 Pin attacco laterale / 6 Pin side fitting |
| | | Lampade <i>Bulbs</i> | 4 x P21W - 3 x R5W |
| Connettore <i>Connector</i> | | 3.49.070.00 | |
| * Ricambio di qualità equivalente <i>Matching quality spare parts</i> | | | |

| MERCEDES | | ACTROS | | LED | |
|---|-----|---|---|--------------------|--|
|  | 19→ | Fanale posteriore <i>Rear lamp</i> | → | 2.44.336.80 | |
| | | Fanale posteriore <i>Rear lamp</i> | ← | 2.44.337.81 | |
| | | 7 funzioni <i>7 functions</i> | | | |
| | | * Ricambio di qualità equivalente <i>Matching quality spare parts</i> | | | |

| MERCEDES | | ACTROS MP4 | |
|---|-----|--|----------------------|
|  | 13→ | Fanale posteriore <i>Rear lamp</i> | → 2.44.276.00 |
| | | Fanale posteriore con cicalino <i>Rear lamp with buzzer</i> | → 2.44.276.70 |
| | | Fanale posteriore con luce targa <i>Rear lamp with number plate light</i> | ← 2.44.277.01 |
| | | Trasparente posteriore <i>Rear lens</i> | → 2.44.276.10 |
| | | | ← 2.44.276.10 |
| * Ricambio di qualità equivalente <i>Matching quality spare parts</i> | | | |



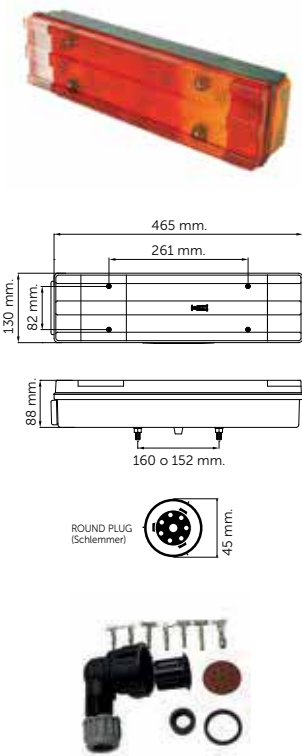

| MERCEDES | ACTROS MP4 | LED |
|---|--|---------------------------|
|  | Fanale posteriore <i>Rear lamp</i> | → 2.44.324.00 |
| | Fanale posteriore con cicalino <i>Rear lamp with buzzer</i> | → 2.44.324.70 |
| | Fanale posteriore con luce targa <i>Rear lamp with number plate light</i> | ← 2.44.325.01 |
| | Trasparente posteriore <i>Rear lens</i> | → ← 2.44.326.20 |
| * Ricambio di qualità equivalente Matching quality spare parts | | |

| MERCEDES | ATEGO | |
|--|--|---|
|  | Fanale posteriore <i>Rear lamp</i> | → 2.44.184.00 |
| | Fanale posteriore con luce targa <i>Rear lamp with number plate light</i> | ← 2.44.185.01 |
| | Trasparente posteriore <i>Rear lens</i> | → ← 2.44.182.20 |
| | Funzioni <i>Functions</i> | 7 |
| | Servizi <i>Services</i> | Direzione / Posizione / Stop / Retromarcia / Retronebbia / Catadiottro <i>Repeater / Parking / Stop / Reversing lamp / Rear fog lamp / Reflector</i> |
| | Fissaggio <i>Fixing</i> | 2 perni / 2 pivots 6 Pin attacco centrale / 6 Pin central fitting |
| | Lampade <i>Bulbs</i> | 4 x P21W - 3 x R5W |
| Connettore <i>Connector</i> | | 3.49.090.00 |
| * Ricambio di qualità equivalente Matching quality spare parts | | |

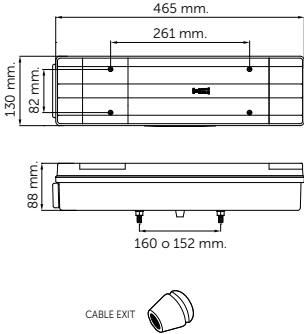
| MERCEDES | SPRINTER | |
|---|---|--|
|  | Fanale posteriore <i>Rear lamp</i> | → 2.44.062.00 ← 2.44.063.00 |
| | Gruppo ottico posteriore <i>Rear optical unit</i> | → 2.44.062.10 ← 2.44.063.10 |
| | Portalampane <i>Bulb holder</i> | 2.44.062.18 |
| | * Ricambio di qualità equivalente Matching quality spare parts | |

| MERCEDES | | SPRINTER | |
|---|-----|--|----------------------|
|  | 06→ | Fanale posteriore <i>Rear lamp</i> | → 5.44.076.00 |
| | | | ← 5.44.077.00 |
| | | Gruppo ottico posteriore <i>Rear optical unit</i> | → 2.44.076.10 |
| | | | ← 2.44.077.10 |

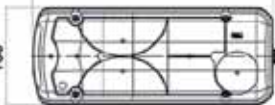
| MERCEDES | | SPRINTER | |
|---|-------|--|---|
|   | 95→02 | Fanale posteriore <i>Rear lamp</i> | → 2.44.182.00 |
| | | Fanale posteriore con luce targa <i>Rear lamp with number plate light</i> | ← 2.44.183.01 |
| | | Trasparente posteriore <i>Rear lens</i> | → ← 2.44.182.20 |
| | | Funzioni <i>Functions</i> | 7 |
| | | Servizi <i>Services</i> | Direzione / Posizione / Stop / Retromarcia / Retronebbia / Side marker <i>Repeater / Parking / Stop / Reversing lamp / Rear fog lamp / Side marker</i> |
| | | Fissaggio <i>Fixing</i> | 2 perni / 2 pivots <i>Con passacavo / With fairlead</i> |
| | | Lampade <i>Bulbs</i> | 4 x P21W - 3 x R5W |
| * Ricambio di qualità equivalente Matching quality spare parts | | | |

| MERCEDES | | SPRINTER | |
|---|-----|--|---|
|      | 06→ | Fanale posteriore <i>Rear lamp</i> | → 5.44.070.00 |
| | | Fanale posteriore con luce targa <i>Rear lamp with number plate light</i> | ← 5.44.071.01 |
| | | Trasparente posteriore <i>Rear lens</i> | → ← 5.44.070.20 5.44.071.20 |
| | | Funzioni <i>Functions</i> | 7 |
| | | Servizi <i>Services</i> | Direzione / Posizione / Stop / Retromarcia / Retronebbia / Side marker <i>Repeater / Parking / Stop / Reversing lamp / Rear fog lamp / Side marker</i> |
| | | Fissaggio <i>Fixing</i> | 2 perni / 2 pivots <i>Con passacavo With fairlead</i> |
| | | Lampade <i>Bulbs</i> | 4 x P21W - 3 x R5W |
| Connettore <i>Connector</i> | | 3.49.070.00 | |
| * Ricambio di qualità equivalente Matching quality spare parts | | | |

| MERCEDES | | SPRINTER | |
|---|-----|---|--------------------|
|  | 05→ | Fanale posteriore 3° stop <i>Additional stop lamp</i> | 2.44.327.00 |
| | | * Ricambio di qualità equivalente Matching quality spare parts | |

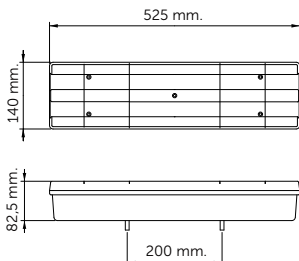
| MERCEDES | | SK | | | |
|---|--|--|---|--|--|
|  |  | Fanale posteriore <i>Rear lamp</i> | → 2.44.172.00 | | |
| | | Fanale posteriore con luce targa <i>Rear lamp with number plate light</i> | ← 2.44.173.01 | | |
| | | Trasparente posteriore <i>Rear Lens</i> | → 2.44.078.20 | | |
| | | | ← 2.44.079.20 | | |
| | | Funzioni <i>Functions</i> | 7 | | |
| | | Servizi <i>Services</i> | Direzione / Posizione / Stop / Retromarcia / Retronebbia / Catadiottro <i>Repeater / Parking / Stop / Reversing lamp / Rear fog lamp / Reflector</i> | | |
| | | Fissaggio <i>Fixing</i> | 2 perni / 2 pivots | | |
| Lampade <i>Bulbs</i> | 4 x P21W - 3 x R5W | | | | |
| Cavo cm. 150 <i>Cable 150 cm.</i> | | | | | |
| * Ricambio di qualità equivalente Matching quality spare parts | | | | | |

| MERCEDES | | II SERIE | |
|---|--|--|----------------------|
|  | | Fanale posteriore <i>Rear lamp</i> | → 2.44.118.00 |
| | | Fanale posteriore con luce targa <i>Rear lamp with number plate light</i> | ← 2.44.119.01 |
| | | Trasparente posteriore <i>Rear lens</i> | → 2.44.118.20 |
| | | | ← 2.44.118.20 |
| * Ricambio di qualità equivalente Matching quality spare parts | | | |

| MERCEDES | | EVOBUS TRAVEGO TOURISMO | |
|---|--|---|----------------------|
|  | | Fanale posteriore <i>Rear lamp</i> | → 2.44.296.00 |
| | | Fanale posteriore <i>Rear lamp</i> | ← 2.44.297.00 |
| | | * Ricambio di qualità equivalente Matching quality spare parts | |

| MERCEDES | | VITO | |
|---|-------|---|----------------------|
|  | 03→13 | Gruppo ottico posteriore <i>Rear optical unit</i> | → 2.44.300.10 |
| | | Gruppo ottico posteriore <i>Rear optical unit</i> | ← 2.44.301.10 |
| | | * Ricambio di qualità equivalente Matching quality spare parts | |

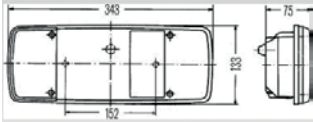
| MERCEDES-MAN | | VARIOUS | |
|---|--|--|---|
|   | | Fanale posteriore <i>Rear lamp</i> | → 2.44.124.00 |
| | | Fanale posteriore <i>Rear lamp</i> | ← 2.44.125.00 |
| | | Fanale posteriore con luce targa <i>Rear lamp with number plate light</i> | ← 2.44.127.01 |
| | | Trasparente posteriore <i>Rear lens</i> | → ← 2.44.124.20 |
| | | Funzioni <i>Functions</i> | 6 |
| | | Servizi <i>Services</i> | Direzione / Posizione / Stop / Retromarcia / Retronebbia / Catadiottro <i>Repeater / Parking / Stop / Reversing lamp / Rear fog lamp / Reflector</i> |
| | | Fissaggio <i>Fixing</i> | 2 perni / 2 pivots Con passacavo / <i>With fairlead</i> |
| | | Lampade <i>Bulbs</i> | 4 x P21W - 3 x R5W |
| * Ricambio di qualità equivalente Matching quality spare parts | | | |

| NISSAN - OPEL - RENAULT | | PRIMASTAR - VIVARO - TRAFIC | |
|---|-------|--|----------------------|
|  | 02→14 | Fanale posteriore <i>Rear lamp</i> | → 5.44.130.00 |
| | | Fanale posteriore <i>Rear lamp</i> | ← 5.44.131.00 |
| | | PER VEICOLI CON 2 PORTE A BATTENTI For vehicles with 2 swing doors Senza porta scorrevole Without sliding doors FURGONE 2X260° VAN 2X260° | |

NISSAN - OPEL - RENAULT

PRIMASTAR - VIVARO - TRAFIC



02→14

Fanale posteriore
Rear lamp



5.44.132.00

Fanale posteriore
Rear lamp



5.44.133.00

PER VEICOLI CON 2 PORTE A BATTENTI | For vehicles with 2 swing doors
Con due porte scorrevoli | For 2 sliding doors
FURGONE 2X260° | VAN 2X260°

NISSAN - OPEL - RENAULT

PRIMASTAR - VIVARO - TRAFIC



02→14

Fanale posteriore
Rear lamp



5.44.130.00

Fanale posteriore
Rear lamp



5.44.133.00

PER VEICOLI CON 2 PORTE A BATTENTI | For vehicles with 2 swing doors
Porta scorrevole a sx | For left sliding door
FURGONE 2X260° | VAN 2X260°

NISSAN - OPEL - RENAULT

PRIMASTAR - VIVARO - TRAFIC



02→14

Fanale posteriore
Rear lamp



5.44.132.00

Fanale posteriore
Rear lamp



5.44.131.00

PER VEICOLI CON 2 PORTE A BATTENTI | For vehicles with 2 swing doors
Porta scorrevole a dx | For right sliding door
FURGONE 2X260° | VAN 2X260°

NISSAN - OPEL - RENAULT

PRIMASTAR - VIVARO - TRAFIC



02→14

Fanale posteriore
Rear lamp



5.44.134.00

Fanale posteriore
Rear lamp



5.44.135.00

PER VEICOLI CON 2 PORTE A BATTENTI | For vehicles with 2 swing doors
Senza porta scorrevole | Without sliding doors
FURGONE 2X180° | VAN 2X180°

NISSAN - OPEL - RENAULT

PRIMASTAR - VIVARO - TRAFIC



02→14

Fanale posteriore
Rear lamp



5.44.136.00

Fanale posteriore
Rear lamp



5.44.137.00

PER VEICOLI CON 2 PORTE A BATTENTI | For vehicles with 2 swing doors
Con due porte scorrevoli | For 2 sliding doors
FURGONE 2X180° | VAN 2X180°

NISSAN - OPEL - RENAULT
PRIMASTAR - VIVARO - TRAFIC

02→14

 Fanale posteriore
Rear lamp

5.44.134.00

 Fanale posteriore
Rear lamp

5.44.137.00

PER VEICOLI CON 2 PORTE A BATTENTI | For vehicles with 2 swing doors
Porta scorrevole a sx | For left sliding door
FURGONE 2X180° | VAN 2X180°

NISSAN - OPEL - RENAULT
PRIMASTAR - VIVARO - TRAFIC

02→14

 Fanale posteriore
Rear lamp

5.44.136.00

 Fanale posteriore
Rear lamp

5.44.135.00

PER VEICOLI CON 2 PORTE A BATTENTI | For vehicles with 2 swing doors
Porta scorrevole a dx | For right sliding door
FURGONE 2X180° | VAN 2X180°

NISSAN - OPEL - RENAULT
PRIMASTAR - VIVARO - TRAFIC

02→14

 Fanale posteriore
Rear lamp

5.44.138.00

 Fanale posteriore
Rear lamp

5.44.139.00

PER VEICOLI CON PORTELLONE | For vehicles with tailgate
Senza porta scorrevole | Without sliding door
Senza foro per cerniera | Without hinge hole

NISSAN - OPEL - RENAULT
PRIMASTAR - VIVARO - TRAFIC

02→14

 Fanale posteriore
Rear lamp

5.44.140.00

 Fanale posteriore
Rear lamp

5.44.141.00

PER VEICOLI CON PORTELLONE | For vehicles with tailgate
Con due porte scorrevoli | For 2 sliding door
Senza foro per cerniera | Without hinge hole

NISSAN - OPEL - RENAULT
PRIMASTAR - VIVARO - TRAFIC

02→14

 Fanale posteriore
Rear lamp

5.44.138.00

 Fanale posteriore
Rear lamp

5.44.141.00

PER VEICOLI CON PORTELLONE | For vehicles with tailgate
Porta scorrevole a sx | For left sliding door
Senza foro per cerniera | Without hinge hole

NISSAN - OPEL - RENAULT

PRIMASTAR - VIVARO - TRAFIC



02→14

Fanale posteriore
Rear lamp



5.44.140.00

Fanale posteriore
Rear lamp



5.44.139.00

PER VEICOLI CON PORTELLONE | For vehicles with tailgate
Porta scorrevole a dx | For right sliding door
Senza foro per cerniera | Without hinge hole

NISSAN-RENAULT

CABSTAR - MASCOTT - MIDLUM LC5

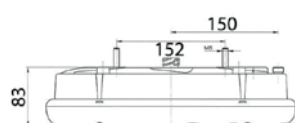
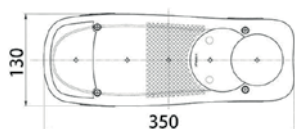

05→

Fanale posteriore
Rear lamp



5.44.122.00

Fanale posteriore con luce targa
Rear lamp with number plate light



5.44.123.00

Trasparente posteriore
Rear lens



5.44.098.20

Funzioni
Functions

6

Servizi
Services

Direzione / Posizione / Stop / Retromarcia / Retronebbia / Catadiotro
Repeater / Parking / Stop / Reversing lamp / Rear fog lamp / Reflector

Fissaggio
Fixing

2 perni / 2 pivots
6 pin

Lampade
Bulbs

4 x P21W - 3 x R5W

Connettore | Connector

3.49.070.00

*** Ricambio di qualità equivalente | Matching quality spare parts**



OPEL-RENAULT

MOVANO - MASTER



Fanale posteriore 3° stop
Additional stop lamp

1.44.094.00

OPEL

MOVANO



03→09

Gruppo ottico posteriore
Rear optical unit



2.44.318.10

Gruppo ottico posteriore
Rear optical unit



2.44.319.10

*** Ricambio di qualità equivalente | Matching quality spare parts**

| OPEL | | MOVANO | |
|---|---|--|----------------------|
|  | 10→ | Gruppo ottico posteriore <i>Rear optical unit</i> | ➔ 2.44.260.10 |
| | | Gruppo ottico posteriore <i>Rear optical unit</i> | ➜ 2.44.261.10 |
| | * Ricambio di qualità equivalente Matching quality spare parts | | |

| RENAULT | | KANGOO | |
|---|---|--|----------------------|
|  | 08→12 | Gruppo ottico posteriore <i>Rear optical unit</i> | ➔ 2.04.106.10 |
| | | Gruppo ottico posteriore <i>Rear optical unit</i> | ➜ 2.04.107.10 |
| | 1 porta 1 door | | |
| | * Ricambio di qualità equivalente Matching quality spare parts | | |

| RENAULT | | KANGOO | |
|---|---|--|----------------------|
|  | 08→12 | Gruppo ottico posteriore <i>Rear optical unit</i> | ➔ 2.04.108.10 |
| | | Gruppo ottico posteriore <i>Rear optical unit</i> | ➜ 2.04.109.10 |
| | 2 porte 2 doors | | |
| | * Ricambio di qualità equivalente Matching quality spare parts | | |

| RENAULT | | KANGOO | |
|---|---|--|----------------------|
|  | 13→ | Gruppo ottico posteriore <i>Rear optical unit</i> | ➔ 2.04.110.10 |
| | | Gruppo ottico posteriore <i>Rear optical unit</i> | ➜ 2.04.111.10 |
| | 1 porta 1 door | | |
| | * Ricambio di qualità equivalente Matching quality spare parts | | |

| RENAULT | | KANGOO | |
|---|---|--|----------------------|
|  | 13→ | Gruppo ottico posteriore <i>Rear optical unit</i> | ➔ 2.04.112.10 |
| | | Gruppo ottico posteriore <i>Rear optical unit</i> | ➜ 2.04.113.10 |
| | 2 porte 2 doors | | |
| | * Ricambio di qualità equivalente Matching quality spare parts | | |

RENAULT

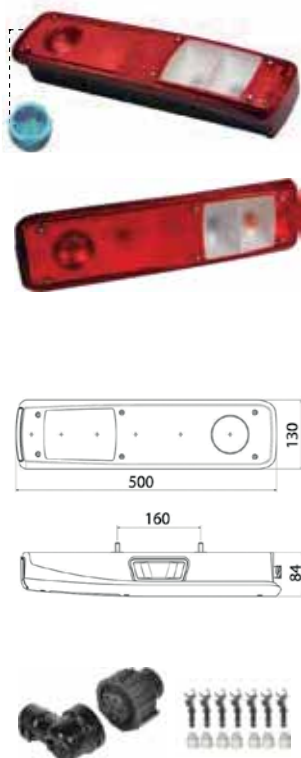

06→

PREMIUM | KERAX | MAGNUM

| | | |
|--|--|--------------------|
| Fanale posteriore <i>Rear lamp</i> | → | 5.44.066.00 |
| Fanale posteriore con luce targa <i>Rear lamp with number plate light</i> | ← | 5.44.067.00 |
| Trasparente posteriore <i>Rear Lens</i> | → ← | 5.44.066.20 |
| Funzioni <i>Functions</i> | 7 | |
| Servizi <i>Services</i> | Direzione / Posizione / Stop / Retromarcia / Retronebbia / Side marker / Catadiottero <i>Repeater / Parking / Stop / Reversing lamp / Rear fog lamp / Side marker / Reflector</i> | |
| Fissaggio <i>Fixing</i> | 2 perni / 2 pivots | |
| Lampade <i>Bulbs</i> | 4 x P21W - 3 x R5W | |
| Connettore <i>Connector</i> | | 3.49.070.00 |
| | | |

RENAULT



16→

EURO 6 T-K-C-D LC9

| | | |
|--|--|--------------------|
| Fanale posteriore <i>Rear lamp</i> | → | 5.44.108.80 |
| Fanale posteriore con cicalino <i>Rear lamp with buzzer</i> | → | 5.44.108.81 |
| Fanale posteriore con luce targa <i>Rear lamp with number plate light</i> | ← | 5.44.109.80 |
| Trasparente posteriore <i>Rear lens</i> | → ← | 5.44.108.20 |
| Funzioni <i>Functions</i> | 7 | |
| Servizi <i>Services</i> | Direzione / Posizione / Stop / Retromarcia / Retronebbia / Side marker / Catadiottero <i>Repeater / Parking / Stop / Reversing lamp / Rear fog lamp / Side marker / Reflector</i> | |
| Fissaggio <i>Fixing</i> | 2 perni / 2 pivots | |
| Lampade <i>Bulbs</i> | 4 x P21W - 3 x R5W | |
| Connettore <i>Connector</i> | | 3.49.070.00 |
| Attacco laterale AMP 1.5 con 7 pin <i>Side connector AMP 1.5 with 7 pins</i> | | |
| | | |

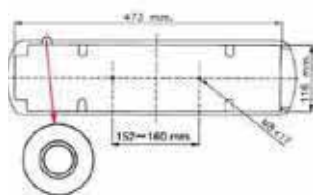
SCANIA
SERIE 4

06→

Fanale posteriore

Rear lamp

2.44.178.00

Fanale posteriore con luce targa

Rear lamp with number plate light

2.44.179.01

Trasparente posteriore

Rear lens

2.44.178.20

 Funzioni
Functions

7

 Servizi
Services

 Direzione / Posizione / Stop / Retromarcia / Retronebbia / Side marker /
 Catadiottro

*Repeater / Parking / Stop / Reversing lamp / Rear fog lamp / Side marker /
 Reflector*

 Fissaggio
Fixing

2 perni / 2 pivots

Passacavo laterale / Cable side

 Lampade
Bulbs

4 x P21W - 3 x R5W

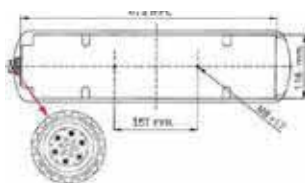
*** Ricambio di qualità equivalente | Matching quality spare parts**
SCANIA
SERIE R

06→

Fanale posteriore

Rear lamp

2.44.180.00

Fanale posteriore con luce targa

Rear lamp with number plate light

2.44.181.01

Trasparente posteriore

Rear lens

2.44.178.20

 Funzioni
Functions

7

 Servizi
Services

 Direzione / Posizione / Stop / Retromarcia / Retronebbia / Side marker /
 Catadiottro

*Repeater / Parking / Stop / Reversing lamp / Rear fog lamp / Side marker /
 Reflector*

 Fissaggio
Fixing



2 perni / 2 pivots

 Lampade
Bulbs



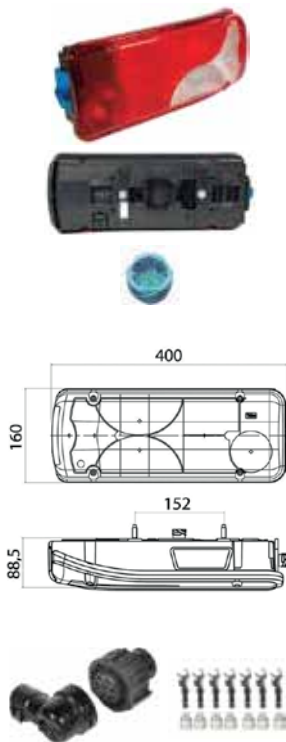

4 x P21W - 3 x R5W



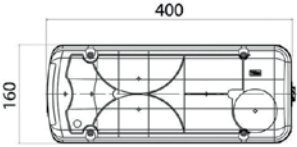
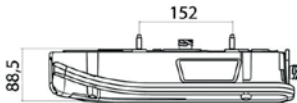

 Connettore / *Connector*
3.49.070.00





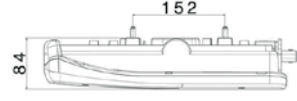

 Attacco laterale DIN 6 poli / *Side fitting DIN 6 pins*
*** Ricambio di qualità equivalente | Matching quality spare parts**









| SCANIA | | P & R | | |
|--|--|---|--------------------|---|
|  <p>06→</p> | Fanale posteriore <i>Rear lamp</i> | → | 5.44.072.00 | |
| | Fanale posteriore con luce targa <i>Rear lamp with number plate light</i> | ← | 5.44.073.01 | |
| | Trasparente posteriore <i>Rear lens</i> | → | 5.44.070.20 | |
| | | ← | 5.44.071.20 | |
| | Funzioni <i>Functions</i> | 7 | | |
| | Servizi <i>Services</i> | Direzione / Posizione / Stop / Retromarcia / Retronebbia / Side marker / Catadiottro <i>Repeater / Parking / Stop / Reversing lamp / Rear fog lamp / Side marker / Reflector</i> | | |
| | Fissaggio <i>Fixing</i> | 2 perni / 2 pivots | | |
| | Lampade <i>Bulbs</i> | 4 x P21W - 3 x R5W | | |
| | Connettore <i>Connector</i> | | | 3.49.070.00 |
| | Attacco laterale DIN 6 poli <i>Side fitting DIN 6 pins</i> | | |  |

| SCANIA | | CF/XF LC11 | | LED | |
|--|--|---|--------------------|--------------------|---|
|  <p>15→</p> | Fanale posteriore <i>Rear lamp</i> | → | 5.44.114.80 | | |
| | Fanale posteriore <i>Rear lamp</i> | ← | 5.44.115.80 | | |
| | Fanale posteriore con luce targa <i>Rear lamp with number plate light</i> | ← | 5.44.115.81 | | |
| | Trasparente posteriore <i>Rear lens</i> | → | 5.44.112.20 | | |
| | | ← | 5.44.113.20 | | |
| | Funzioni <i>Functions</i> | 7 | | | |
| | Servizi <i>Services</i> | Direzione / Posizione / Stop / Retromarcia / Retronebbia / Side marker / Catadiottro <i>Repeater / Parking / Stop / Reversing lamp / Rear fog lamp / Side marker / Reflector</i> | | | |
| | Fissaggio <i>Fixing</i> | 2 perni / 2 pivots | | | |
| | Lampade <i>Bulbs</i> | 4 x P21W - 3 x R5W | | | |
| | Connettore <i>Connector</i> | | | 3.49.070.00 | |
| Attacco laterale AMP 1.5 <i>Side connector AMP 1.5</i> | | | | |  |

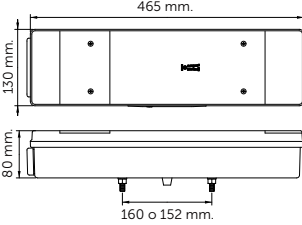
| SCANIA | | P&R LC8 | |
|---|--------------------|---|--|
|    | 13→ | Fanale posteriore <i>Rear lamp</i> |  5.44.110.00 |
| | | Fanale posteriore con luce targa <i>Rear lamp with number plate light</i> |  5.44.111.00 |
| | | Funzioni <i>Functions</i> | 7 |
| | | Servizi <i>Services</i> | Direzione / Posizione / Stop / Retromarcia / Retronebbia / Side marker / Catadiottero <i>Repeater / Parking / Stop / Reversing lamp / Rear fog lamp / Side marker / Reflector</i> |
| | | Fissaggio <i>Fixing</i> | 2 perni / 2 pivots |
| Lampade <i>Bulbs</i> | 4 x P21W - 3 x R5W | | |
| Attacco posteriore AMP 1.5 / <i>Rear connector AMP 1.5</i> | |  | |

| SCANIA | | P&R LC11 | | LED | |
|--|--|--|--|---|--|
|     | 16→ | Fanale posteriore <i>Rear lamp</i> |  5.44.112.80 | | |
| | | Fanale posteriore con luce targa <i>Rear lamp with number plate light</i> |  5.44.113.81 | | |
| | | Trasparente posteriore <i>Rear lens</i> |  5.44.112.20 | | |
| | | Trasparente posteriore <i>Rear lens</i> |  5.44.113.20 | | |
| | | Funzioni <i>Functions</i> | 7 | | |
| Servizi <i>Services</i> | Direzione / Posizione / Stop / Retromarcia / Retronebbia / Side marker / Catadiottero <i>Repeater / Parking / Stop / Reversing lamp / Rear fog lamp / Side marker / Reflector</i> | | | | |
| Fissaggio <i>Fixing</i> | 2 perni / 2 pivots | | | | |
| Lampade <i>Bulbs</i> | 4 x P21W - 3 x R5W | | | | |
| Connettore / <i>Connector</i> | | | | 3.49.070.00 | |
| Attacco posteriore AMP 1.5 / <i>Rear connector AMP 1.5</i> | | | |  | |

| SCANIA | SERIE 6 L-P-G-R-S | LED |
|--|--|--|
|   | 16→ Fanale posteriore <i>Rear lamp</i> |  2.44.328.80 |
| | Fanale posteriore con luce targa <i>Rear lamp with number plate light</i> |  2.44.329.81 |
| | Fanale posteriore con cicalino <i>Rear lamp with buzzer</i> |  2.44.328.81 |
| | Trasparente posteriore <i>Rear lens</i> |  2.44.328.20 |
| | Trasparente posteriore <i>Rear lens</i> |  2.44.329.20 |
| 7 funzioni 7 functions | | |
| * Ricambio di qualità equivalente Matching quality spare parts | | |



| VOLVO | 6 PIN | |
|---|--|--|
|   <p>Attacco Volvo Plug <i>Rear Volvo Plug</i></p>  <p>SQUARE PLUG (Volvo plug)</p>  | Fanale posteriore <i>Rear lamp</i> |  2.44.174.00 |
| | Fanale posteriore <i>Rear lamp</i> |  2.44.175.01 |
| | Trasparente posteriore <i>Rear lens</i> |   2.44.174.20 |
| | Funzioni <i>Functions</i> | 7 |
| | Servizi <i>Services</i> | Direzione / Posizione / Stop / Retromarcia / Retronebbia / Side marker / Catadiottro Repeater / Parking / Stop / Reversing lamp / Rear fog lamp / Side marker / Reflector |
| Fissaggio <i>Fixing</i> | 2 perni / 2 pivots Attacco Volvo Plug Rear Volvo Plug | |
| Lampade <i>Bulbs</i> | 4 x P21W - 3 x R5W | |
| * Ricambio di qualità equivalente Matching quality spare parts | | |

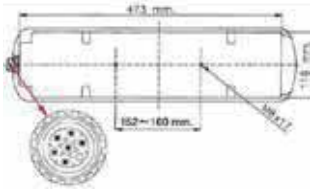

| VOLVO | | FH - FM TRACTOR | |
|---|-----|--|---------------------------|
|  | 05→ | Fanale posteriore <i>Rear lamp</i> | → 2.44.290.00 |
| | | Fanale posteriore con luce targa <i>Rear lamp with number plate light</i> | ← 2.44.291.01 |
| | | Trasparente posteriore <i>Rear lens</i> | → ← 2.44.290.20 |
| | | Connettore / <i>Connector</i> | 3.49.070.00 |
| | | * Ricambio di qualità equivalente Matching quality spare parts | |

| VOLVO | | FH - FM | |
|--|-----|--|---------------------------|
|  | 04→ | Fanale posteriore <i>Rear lamp</i> | → 2.44.292.00 |
| | | Fanale posteriore con luce targa <i>Rear lamp with number plate light</i> | ← 2.44.293.01 |
| | | Trasparente posteriore <i>Rear lens</i> | → ← 2.44.292.20 |
| | | Connettore / <i>Connector</i> | 3.49.070.00 |
| | | * Ricambio di qualità equivalente Matching quality spare parts | |

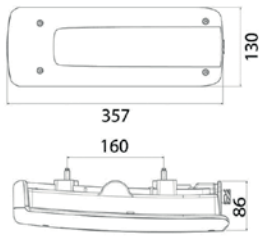
| VOLVO | | FH - FM - FL | |
|---|-------|--|---|
|  | 01→06 | Fanale posteriore <i>Rear lamp</i> | → 2.44.188.00 |
| | | Fanale posteriore con luce targa <i>Rear lamp with number plate light</i> | ← 2.44.189.01 |
| | | Trasparente posteriore <i>Rear lens</i> | → ← 2.44.178.20 |
| | | Funzioni <i>Functions</i> | 7 |
| | | Servizi <i>Services</i> | Direzione / Posizione / Stop / Retromarcia / Retronebbia / Side marker / Catadiottro <i>Repeater / Parking / Stop / Reversing lamp / Rear fog lamp / Side marker / Reflector</i> |
| | | Fissaggio <i>Fixing</i> | 2 perni / 2 pivots Con passacavo laterale / <i>Cable side</i> |
| | | Lampade <i>Bulbs</i> | 4 x P21W - 3 x R5W |
| | | * Ricambio di qualità equivalente Matching quality spare parts | |

| VOLVO | | FH - FM - PRE 2001 | |
|--|-------|--|---|
|   | 01→11 | Fanale posteriore <i>Rear lamp</i> | → 2.44.186.00 |
| | | Fanale posteriore con luce targa <i>Rear lamp with number plate light</i> | ← 2.44.187.01 |
| | | Trasparente posteriore <i>Rear lens</i> | → ← 2.44.178.20 |
| | | Funzioni <i>Functions</i> | 7 |
| | | Servizi <i>Services</i> | Direzione / Posizione / Stop / Retromarcia / Retronebbia / Side marker / Catadiottro <i>Repeater / Parking / Stop / Reversing lamp / Rear fog lamp / Side marker / Reflector</i> |
| | | Fissaggio <i>Fixing</i> | 2 perni / 2 pivots |
| | | Lampade <i>Bulbs</i> | 4 x P21W - 3 x R5W |
| Attacco laterale DIN 6 poli <i>Side fitting DIN 6 pins</i> | | | |
| * Ricambio di qualità equivalente Matching quality spare parts | | | |

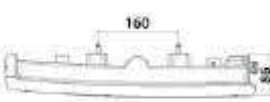
| VOLVO | | FH 13 LC10 | | LED | |
|---|-----|--|---------------------------|-----|--|
|    | 13→ | Fanale posteriore <i>Rear lamp</i> | → 5.44.118.80 | | |
| | | Fanale posteriore <i>Rear lamp</i> | ← 5.44.119.80 | | |
| | | Fanale posteriore con luce targa <i>Rear lamp with number plate light</i> | ← 5.44.119.81 | | |
| | | Trasparente posteriore <i>Rear lens</i> | → ← 5.44.118.20 | | |
| | | Attacco laterale AMP 1.5 <i>Side connector AMP 1.5</i> | | | |

| VOLVO | | FM 12 EURO 6 LC9 | | LED | |
|---|-----|--|---------------------------|-----|--|
|    | 12→ | Fanale posteriore <i>Rear lamp</i> | → 5.44.108.80 | | |
| | | Fanale posteriore <i>Rear lamp</i> | ← 5.44.109.80 | | |
| | | Trasparente posteriore <i>Rear lens</i> | → ← 5.44.108.20 | | |
| | | Attacco laterale AMP 1.5 <i>Side connector AMP 1.5</i> | | | |

| VOLKSWAGEN | | CADDY | |
|---|--|--|----------------------|
|  | 15→ | Gruppo ottico posteriore <i>Rear optical unit</i> | ➔ 2.04.120.10 |
| | | Gruppo ottico posteriore <i>Rear optical unit</i> | ➔ 2.04.121.10 |
| | 1 porta / 1 door | | |
| | * Ricambio di qualità equivalente Matching quality spare parts | | |

| VOLKSWAGEN | | CRAFTER | |
|---|--|--|----------------------|
|  | 06→16 | Gruppo ottico posteriore <i>Rear optical unit</i> | ➔ 2.44.214.10 |
| | | Gruppo ottico posteriore <i>Rear optical unit</i> | ➔ 2.44.215.10 |
| | * Ricambio di qualità equivalente Matching quality spare parts | | |

| VOLKSWAGEN | | CRAFTER | |
|---|--|--|----------------------|
|  | 17→ | Gruppo ottico posteriore <i>Rear optical unit</i> | ➔ 2.44.302.10 |
| | | Gruppo ottico posteriore <i>Rear optical unit</i> | ➔ 2.44.303.10 |
| | * Ricambio di qualità equivalente Matching quality spare parts | | |

| VOLKSWAGEN | | TRANSPORTER LT2 | |
|---|--|---------------------------------------|----------------------|
|  | 98→05 | Fanale posteriore <i>Rear lamp</i> | ➔ 2.44.112.00 |
| | | Fanale posteriore <i>Rear lamp</i> | ➔ 2.44.113.00 |
| | * Ricambio di qualità equivalente Matching quality spare parts | | |

| VOLKSWAGEN | | TRANSPORTER T5 | |
|---|--|--|----------------------|
|  | 03→09 | Gruppo ottico posteriore <i>Rear optical unit</i> | ➔ 2.44.308.10 |
| | | Gruppo ottico posteriore <i>Rear optical unit</i> | ➔ 2.44.309.10 |
| | 1 porta / 1 door | | |
| | * Ricambio di qualità equivalente Matching quality spare parts | | |

| VOLKSWAGEN | | TRANSPORTER T5 | |
|---|-------------------|--|---|
|  | 03→09 | Gruppo ottico posteriore <i>Rear optical unit</i> | → 2.44.310.10 |
| | | Gruppo ottico posteriore <i>Rear optical unit</i> | ← 2.44.311.10 |
| | 2 porte 2 doors | | * Ricambio di qualità equivalente Matching quality spare parts |

| VOLKSWAGEN | | TRANSPORTER T6 | |
|--|-------------------|--|---|
|  | 15→ | Gruppo ottico posteriore <i>Rear optical unit</i> | → 2.44.306.10 |
| | | Gruppo ottico posteriore <i>Rear optical unit</i> | ← 2.44.307.10 |
| | 2 porte 2 doors | | * Ricambio di qualità equivalente Matching quality spare parts |

| UNIVERSALE | AUTOBUS | LED |
|---|---|--------------------|
|  | Fanale posizione / stop <i>Parking / stop lamp</i> | 2.44.156.80 |
| | 9-33V Dimensioni / Dimension Ø 100 mm. | |
| | * Ricambio di qualità equivalente Matching quality spare parts | |

| UNIVERSALE | AUTOBUS | LED |
|---|---|--------------------|
|  | Fanale direzione <i>Repeater lamp</i> | 2.44.160.80 |
| | 9-33V Dimensioni / Dimension Ø 100 mm. | |
| | * Ricambio di qualità equivalente Matching quality spare parts | |

| UNIVERSALE | AUTOBUS | | |
|---|--|--|---------------------------|
|  | <p>Fanale catadiottro <i>Reflector</i></p> | | <p>2.44.162.80</p> |
| <p>Dimensioni / Dimension \varnothing 100 mm.</p> | | | |
| <p>* Ricambio di qualità equivalente Matching quality spare parts</p> | | | |

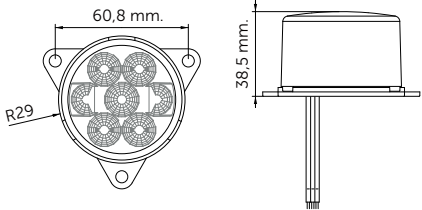
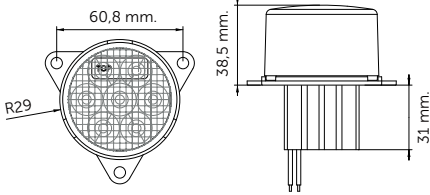
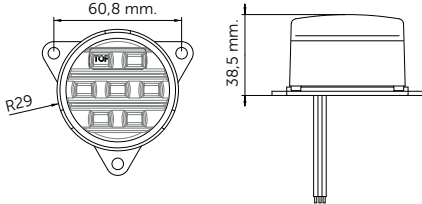
| UNIVERSALE | AUTOBUS | LED |
|--|--|---------------------------|
|  | <p>Fanale direzione <i>Repeater lamp</i></p> | <p>2.44.140.80</p> |
| | <p>Fanale posizione / stop <i>Parking / stop lamp</i></p> | <p>2.44.144.80</p> |
| |  | |
| | <p>Fanale posteriore retronebbia <i>Rear fog lamp</i></p> | <p>2.44.148.80</p> |
|  | | |
| <p>Fanale posteriore retromarcia <i>Rear reverse lamp</i></p> | <p>2.44.152.80</p> | |
|  | | |
| <p>9-33V</p> | | |
| <p>* Ricambio di qualità equivalente Matching quality spare parts</p> | | |

| UNIVERSALE | AUTOBUS | | |
|---|---|--|--------------------|
|  | Fanale posizione rosso <i>Red parking lamp</i> | | 2.44.168.00 |
| | Fanale stop rosso <i>Red stop lamp</i> | | 2.44.167.00 |
| | Fanale posteriore rosso posizione / stop <i>Red rear stop / parking lamp</i> | | 2.44.166.00 |
| | Fanale direzione anteriore arancio <i>Orange front repeater lamp</i> | | 2.41.076.00 |
| | Fanale direzione posteriore arancio <i>Orange rear repeater lamp</i> | | 2.44.169.00 |
| | Fanale posteriore retromarcia <i>Rear reverse lamp</i> | | 2.44.171.00 |
| | Fanale posteriore retronebbia rosso <i>Red rear fog lamp</i> | | 2.44.170.00 |
| * Ricambio di qualità equivalente Matching quality spare parts | | | |

| UNIVERSALE | AUTOBUS TRUCKS | | |
|---|---|--|--------------------|
|  | Fanale posteriore posizione <i>Rear parking lamp</i> | | 2.44.128.00 |
| | Fanale posteriore stop <i>Rear stop lamp</i> | | 2.44.130.00 |
| | Fanale posteriore retronebbia <i>Rear fog lamp</i> | | 2.44.132.00 |
| | Trasparente posteriore rosso <i>Red rear lens</i> | | 2.44.128.21 |
| | Fanale posteriore direzione <i>Rear repeater lamp</i> | | 2.44.134.00 |
| | Trasparente posteriore arancio <i>Orange rear lens</i> | | 2.44.134.11 |
| | Fanale posteriore retromarcia <i>Rear reverse lamp</i> | | 2.44.136.00 |
| | Trasparente posteriore incolore <i>Clear rear lens</i> | | 2.44.136.25 |
| * Ricambio di qualità equivalente Matching quality spare parts | | | |

| UNIVERSALE | COBINO ROULOTTE | |
|---|---|----------------------|
|  | Fanale posteriore <i>Rear lamp</i> | ➔ 2.44.106.00 |
| | Fanale posteriore con luce targa <i>Rear lamp with number plate light</i> | ➜ 2.44.107.01 |
| | Trasparente posteriore <i>Rear lens</i> | ➔ 2.44.106.20 |
| | Trasparente posteriore con luce targa <i>Rear lens with number plate light</i> | ➜ 2.44.107.21 |
| * Ricambio di qualità equivalente Matching quality spare parts | | |



| UNIVERSALE | ECOLED | LED |
|--|---------------------------------------|----------------------|
|  | Fanale posteriore <i>Rear lamp</i> | ➔ 7.44.090.80 |
| | Fanale posteriore <i>Rear lamp</i> | ➜ 7.44.091.80 |
| | 24V | |
| | Connettore <i>Connector</i> | 3.49.080.00 |

| UNIVERSALE | EUROPOINT III | |
|---|--|----------------------|
|  | Fanale posteriore <i>Rear lamp</i> | ➔ 7.44.092.00 |
| | Fanale posteriore <i>Rear lamp</i> | ➜ 7.44.093.00 |
| | Luce di posizione con guida luce <i>Position light with light guides</i> | |

| UNIVERSALE | EUROPOINT III | |
|---|--|----------------------|
|  | Fanale posteriore con stop a led <i>Rear lamp with led stop</i> | ➔ 7.44.094.80 |
| | Fanale posteriore con stop a led <i>Rear lamp with led stop</i> | ➜ 7.44.095.80 |
| | Connettore <i>Connector</i> | 3.49.080.00 |

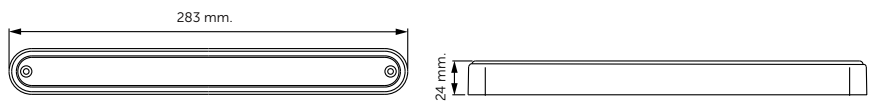
| UNIVERSALE | EUROPOINT III | FULL LED |
|---|--|----------------------|
|  | Fanale posteriore <i>Rear lamp</i> | → 7.44.096.80 |
| | Fanale posteriore <i>Rear lamp</i> | ← 7.44.097.80 |
| | Trasparente posteriore <i>Rear lens</i> | → 7.44.096.20 |
| | Trasparente posteriore <i>Rear lens</i> | ← 7.44.097.20 |
| | Connettore <i>Connector</i> | 3.49.080.00 |

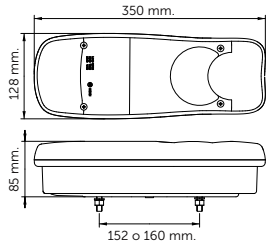
| UNIVERSALE | LED | |
|---|---|--------------------|
|  | Fanale posteriore 3° stop <i>Additional stop light</i> | 2.44.204.80 |
| | 96→ 12 led 24V  | |
| * Ricambio di qualità equivalente <i>Matching quality spare parts</i> | | |

| UNIVERSALE | | |
|---|---|---------------------------|
|    | Fanale posteriore <i>Rear lamp</i> | → ← 2.44.066.00 |
| | Fanale posteriore con luce targa <i>Rear lamp with number plate light</i> | ← 2.44.067.00 |
| | Fanale posteriore con cavo <i>Rear lamp with cable</i> | → 2.44.208.00 |
| | Fanale posteriore con luce targa e cavo <i>Rear lamp with number plate light and cable</i> | ← 2.44.209.01 |
| | Trasparente posteriore <i>Rear lens</i> | → ← 2.44.066.20 |
| | Connettore <i>Connector</i> | 3.49.070.00 |
| | * Ricambio di qualità equivalente <i>Matching quality spare parts</i> | |

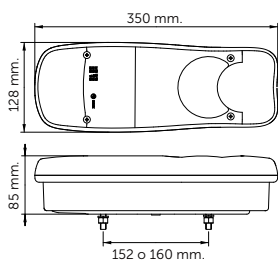
UNIVERSALE
LED

Fanale posteriore
Rear lamp



2.44.066.80

Fanale posteriore
Rear lamp



2.44.067.80

Trasparente posteriore
Rear lens



2.44.066.30

Funzioni
Functions

6

Servizi
Services

Direzione / Posizione / Stop / Retromarcia / Retronebbia / Catadiottro
Repeater / Parking / Stop / Reversing lamp / Rear fog lamp / Reflector

Voltaggio
Voltage

10-30V DC

Connettore | *Connector*

3.49.070.00

Attacco AMP | *Connector AMP*

*** Ricambio di qualità equivalente | Matching quality spare parts**

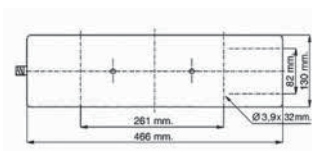
UNIVERSALE

Fanale posteriore con cavo
Rear lamp with cable



2.44.262.00

Fanale posteriore con cavo
Rear lamp with cable



2.44.263.00

Fanale posteriore con cavo e luce targa
Rear lamp with cable and number plate light



2.44.263.01

Funzioni
Functions

7

Servizi
Services

Direzione / Posizione / Stop / Retromarcia / Retronebbia /
Ingombro arancio / Catadiottro
*Repeater / Parking / Stop / Reversing lamp / Rear fog lamp /
Orange side marker / Reflector*

Fissaggio
Fixing

2 perni / 2 pivots

Lampade
Bulbs

4 x P21W - 3 x R5W

*** Ricambio di qualità equivalente | Matching quality spare parts**

UNIVERSALE

LED

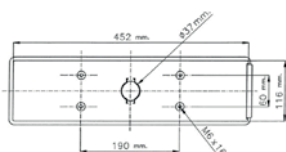

Fanale posteriore
Rear lamp



2.44.238.80

Fanale posteriore
Rear lamp



2.44.239.80

Fanale posteriore con luce targa
Rear lamp with number plate light



2.44.239.81

Trasparente posteriore
Rear lens



2.44.238.20

Funzioni
Functions

7

Servizi
Services

Direzione / Posizione / Stop / Retromarcia / Retronebbia / Side marker /
Catadiottro
Repeater / Parking / Stop / Reversing lamp / Rear fog lamp / Side marker /
Reflector

Fissaggio
Fixing

2 perni / 2 pivots

Connettore / Connector

3.49.090.00

24V

*** Ricambio di qualità equivalente | Matching quality spare parts**

UNIVERSALE

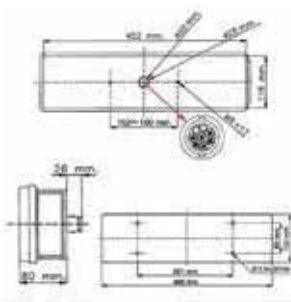

Fanale posteriore con luce targa e retromarcia
Rear lamp with number plate light and reversing lamp



2.44.224.00

Fanale posteriore con luce targa e retronebbia
Rear lamp with number plate light and rear fog lamp



2.44.225.00

Trasparente posteriore con retromarcia
Rear lens with reversing lamp



2.44.224.20

Trasparente posteriore con retronebbia
Rear lens with rear fog lamp



2.44.225.20

Funzioni
Functions

5

Servizi
Services

Direzione / Posizione / Stop / Retromarcia / Retronebbia / Side marker
Repeater / Parking / Stop / Reversing lamp / Rear fog lamp / Side marker

Fissaggio
Fixing

2 perni / 2 pivots

Dimensioni mm. 200x110 | Interasse 55 mm.

Dimension mm. 200x110 | Interaxis distance 55 mm.

*** Ricambio di qualità equivalente | Matching quality spare parts**

UNIVERSALE
LED

 Fanale posteriore
Rear lamp

2.44.280.80

 Fanale posteriore
Rear lamp

2.44.281.80

 Fanale posteriore
Rear lamp

2.44.282.80

 Fanale posteriore
Rear lamp

2.44.283.80

 Funzioni
Functions

7

 Servizi
Services

 Posizione / Stop / Direzione / Retromarcia / Retronebbia / Targa / Catadiottro
Rear position / Stop / Repeater / Reversing lamp / Rear fog lamp /
Number plate light / Reflector

 Fissaggio
Fixing

2 perni | 2 pivots

12/24V | Dimensioni mm. 304x48 | Cavo mm. 1500

12/24V | Dimension mm. 304x48 | Cable mm. 1500

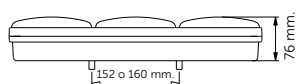
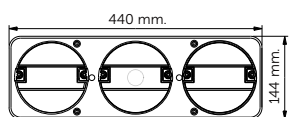
*** Ricambio di qualità equivalente | Matching quality spare parts**
UNIVERSALE
LED

 Fanale posteriore
Rear lamp

2.44.082.80

 Fanale posteriore
Rear lamp

2.44.083.80

 Funzioni
Functions

5

 Servizi
Services





 Direzione / Posizione / Stop / Retromarcia / Retronebbia / Side marker
Repeater / Parking / Stop / Reversing lamp / Rear fog lamp / Side marker

 Fissaggio
Fixing

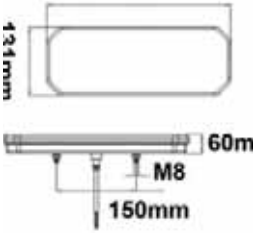

2 perni / 2 pivots

10-30V

 Connettore | *Connector*
3.49.070.00
*** Ricambio di qualità equivalente | Matching quality spare parts**

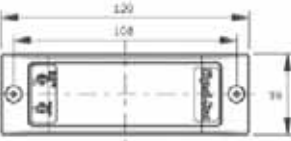
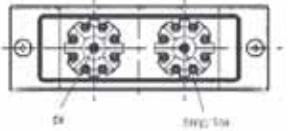
| UNIVERSALE | | LED | | |
|---|---|--|---------------------------|--|
|    | <p>Fanale posteriore con freccia dinamica <i>Rear lamp with dynamic indicator</i></p> |  | <p>2.44.330.80</p> | |
| | <p>Fanale posteriore con freccia dinamica <i>Rear lamp with dynamic indicator</i></p> |  | <p>2.44.331.80</p> | |
| | <p>Modulo di assorbimento 24V <i>24V absorption module</i></p> | | <p>2.44.330.50</p> | |
| | <p>Funzioni <i>Functions</i></p> | <p>7</p> | | |
| | <p>Servizi <i>Services</i></p> | <p>Direzione / Posizione / Stop / Retronebbia / Retromarcia / Ingombro arancio / Catadiotro <i>Repeater / Parking / Stop / Reversing lamp / Rear fog lamp / Orange side marker / Reflector</i></p> | | |
| <p>24V Cavo mm. 450 / <i>Cable mm. 450</i></p> | | <p>* Ricambio di qualità equivalente <i>Matching quality spare parts</i></p> | | |

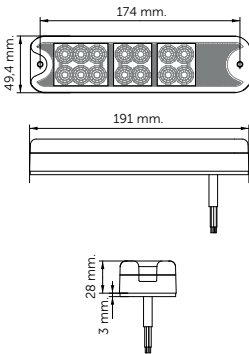
| UNIVERSALE | | LED | |
|--|--|-----|---------------------------|
|    | <p>Fanale posteriore posizione / stop / direzione <i>Rear parking / stop / repeater lamp</i></p> | | <p>4.44.112.80</p> |
| | <p>Fanale posteriore retronebbia / retromarcia <i>Rear fog and reverse lamp</i></p> | | <p>4.44.113.80</p> |
| | <p>12-24V Dimensioni mm. 120x39 <i>12-24V Dimension mm. 120x39</i></p> | | |

| UNIVERSALE | | LED | | |
|--|---|--|---|--|
|   | <p>Fanale posteriore <i>Rear lamp</i></p> |   | <p>2.44.210.80</p> | |
| | <p>Funzioni <i>Functions</i></p> | <p>3</p> | | |
| | <p>Servizi <i>Services</i></p> | <p>Direzione / Posizione / Stop / Catadiotro <i>Repeater / Parking / Stop / Reflector</i></p> | | |
| | <p>Fissaggio <i>Fixing</i></p> | <p>Base piana <i>Flat base</i></p> | | |
| | <p>14 led 10-30V</p> | | <p>* Ricambio di qualità equivalente <i>Matching quality spare parts</i></p> | |

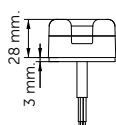
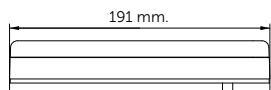
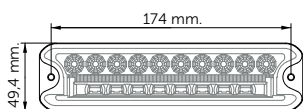
UNIVERSALE
LED

Fanale posteriore
Rear lamp



2.44.212.80

Fanale posteriore
Rear lamp



2.44.213.80

Funzioni
Functions

4

Servizi
Services

Direzione / Stop / Posizione / Catadiottro
Repeater / Stop / Parking / Reflector

Fissaggio
Fixing

Base piana | Flate base

14 led | 10-30V

*** Ricambio di qualità equivalente | Matching quality spare parts**

UNIVERSALE

96→

Fanale posteriore
Rear lamp



2.44.076.01



Trasparente posteriore
Rear lens



2.44.076.20

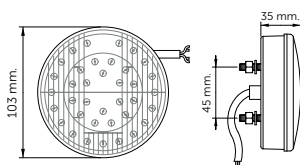

*** Ricambio di qualità equivalente | Matching quality spare parts**

UNIVERSALE
LED

96→

Fanale posteriore posizione / stop / direzione 12V
Rear parking / stop / repeater lamp 12V

2.44.092.80

Fanale posteriore posizione / stop / direzione 24V
Rear parking / stop / repeater lamp 24V

2.44.094.80

Fanale posteriore retronebbia / stop 12V
Rear fog / stop lamp 12V

2.44.096.80

Fanale posteriore retronebbia 24V
Rear fog lamp 24V

2.44.098.80

Fanale posteriore retromarcia 12V
Rear reverse lamp 12V

2.44.100.80

Fanale posteriore retromarcia 24V
Rear reverse lamp 24V

2.44.102.80

38 led | Dimensioni Ø 103 mm. / Dimension Ø 103 mm.





*** Ricambio di qualità equivalente | Matching quality spare parts**

| UNIVERSALE | | LED | |
|---|-----|--|--------------------|
|  | 96→ | Fanale posteriore posizione / stop / direzione <i>Rear parking / stop / repeater lamp</i> | 2.44.084.80 |
| | | Fanale posteriore posizione / stop / direzione con trasparente incolore <i>Rear parking / stop / repeater lamp with clear lens</i> | 2.44.086.80 |
| | | Fanale posteriore retronebbia con trasparente rosso <i>Rear fog lamp with red lens</i> | 2.44.088.80 |
| | | Fanale posteriore retronebbia con trasparente incolore <i>Rear fog lamp with clear lens</i> | 2.44.087.80 |
| | | Fanale posteriore retromarcia <i>Rear reverse lamp</i> | 2.44.089.80 |
| | | 18 led 9-33V Dimensioni Ø 140 mm. / Dimension Ø 140 mm. | |
| * Ricambio di qualità equivalente Matching quality spare parts | | | |

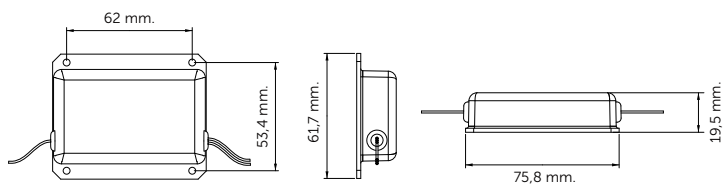
| UNIVERSALE | | LED | |
|---|-----|--|--------------------|
|  | 96→ | Fanale direzione arancio <i>Orange repeater lamp</i> | 2.42.094.80 |
| | | Fanale anteriore direzione <i>Repeater front lamp</i> | 2.41.078.80 |
| | | Fanale posteriore posizione /stop/ direzione <i>Rear parking / stop / repeater lamp</i> | 2.44.194.80 |
| | | Fanale posteriore retromarcia <i>Red rear reverse lamp</i> | 2.44.196.80 |
| | | Fanale posteriore rosso stop / posizione <i>Red rear stop / parking lamp</i> | 2.44.195.80 |
| | | Fanale posteriore retronebbia <i>Rear fog lamp</i> | 2.44.198.80 |
| 9-33V Dimensioni / Dimension Ø 95 mm. | | | |
| * Ricambio di qualità equivalente Matching quality spare parts | | | |

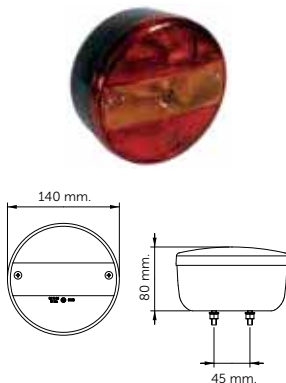

| UNIVERSALE | | LED | |
|---|-----|--|--------------------|
|  | 96→ | Fanale posteriore posizione / stop / direzione <i>Rear parking / stop / repeater lamp</i> | 2.44.268.80 |
| | | Fanale posteriore retromarcia <i>Rear reverse lamp</i> | 2.44.270.80 |
| | | Fanale posteriore retronebbia <i>Rear fog lamp</i> | 2.44.271.80 |
| | | 20 led 24V Dimensioni Ø 135 mm. / <i>Dimension Ø 135 mm.</i> | |
| * Ricambio di qualità equivalente Matching quality spare parts | | | |

| UNIVERSALE | MODULO DI RICARICO | LED | |
|---|---|-----|--------------------|
|  75x61x19 | Aggiunge 10 Watt di carico per fanali 24V <i>Adds 10 Watt load for 24V lamps</i> | | 3.49.088.00 |
| | Aggiunge 10 Watt di carico per fanali a 12V <i>Adds 10 Watt load for 12V lamps</i> | | 3.49.089.00 |
| | Dimensioni / <i>Dimension 750x610x190 mm.</i> | | |
| |  | | |
| * Ricambio di qualità equivalente Matching quality spare parts | | | |

| UNIVERSALE | RIMORCHI TRAILERS | | |
|---|---------------------|--|---|
|  | 96→ | Fanale posteriore <i>Rear lamp</i> |  2.44.074.00 |
| | | Fanale posteriore con luce targa <i>Rear lamp with number plate light</i> |  2.44.075.01 |
| | | Trasparente posteriore <i>Rear lens</i> |   2.44.074.20 |
| | | * Ricambio di qualità equivalente Matching quality spare parts | |

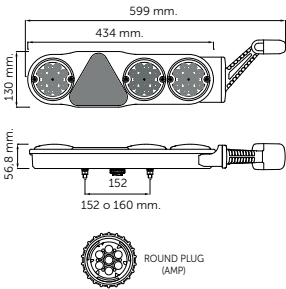
| UNIVERSALE | RIMORCHI TRAILERS | |
|---|--|----------------------|
|  | Fanale posteriore <i>Rear lamp</i> | ➔ 2.44.254.00 |
| | Fanale posteriore con luce targa <i>Rear lamp with number plate light</i> | ➔ 2.44.255.01 |
| | Trasparente posteriore <i>Rear lens</i> | 2.44.254.20 |
| * Ricambio di qualità equivalente Matching quality spare parts | | |

| UNIVERSALE | RIMORCHI TRAILERS | LED |
|--|---|----------------------|
|   | Fanale posteriore rimorchio con ingombro <i>Trailer rear lamp with side marker</i> | ➔ 2.44.192.81 |
| | Fanale posteriore rimorchio con ingombro <i>Trailer rear lamp with side marker</i> | ➔ 2.44.193.81 |
| | 10-33V Dimensioni / Dimension mm. 434x130 | |
| * Ricambio di qualità equivalente Matching quality spare parts | | |

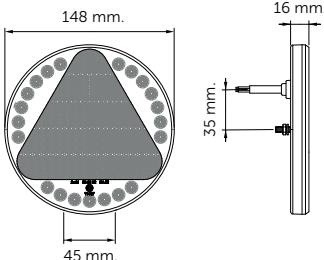
| UNIVERSALE | RIMORCHI TRAILERS | LED |
|--|---|--------------------|
|   | Fanale posteriore 4 funzioni con catadiottero triangolare <i>Rear lamp 4 functions with triangular reflector</i> | 2.44.250.80 |
| | Fanale posteriore retromarcia <i>Rear reversing lamp</i> | 2.44.252.80 |
| |  | |
| * Ricambio di qualità equivalente Matching quality spare parts | | |

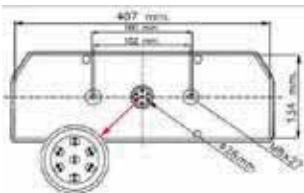
UNIVERSALE
RIMORCHI | TRAILERS

 Fanale posteriore
Rear lamp

2.44.068.00

 Fanale posteriore
Rear lamp

2.44.069.00

 Trasparente posteriore
Rear lens

2.44.068.20

 Trasparente posteriore
Rear lens

2.44.069.20

 Funzioni
Functions

7

 Servizi
Services

 Direzione / Posizione / Stop / Retromarcia / Retronebbia / Side marker /
 Catadiottero
Repeater / Parking / Stop / Reversing lamp / Rear fog lamp / Side marker /
Reflector

 Fissaggio
Fixing

4 perni / 4 pivots

 Lampade
Bulbs

4 x P21W - 3 x R5W

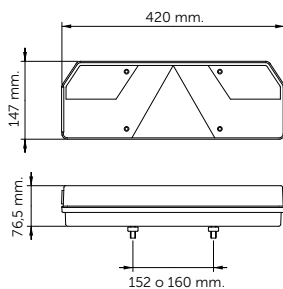
 Connettore | *Connector*
3.49.080.00
*** Ricambio di qualità equivalente | Matching quality spare parts**
UNIVERSALE
RIMORCHI | TRAILERS

CABLE EXIT

 Fanale posteriore
Rear lamp

2.44.104.00

 Fanale posteriore
Rear lamp

2.44.105.00

 Trasparente posteriore
Rear lens

2.44.068.20

 Trasparente posteriore
Rear lens

2.44.069.20

 Funzioni
Functions

7

 Servizi
Services

 Direzione / Posizione / Stop / Retromarcia / Retronebbia / Side marker /
 Catadiottero
Repeater / Parking / Stop / Reversing lamp / Rear fog lamp / Side marker /
Reflector

 Fissaggio
Fixing

 4 perni / 4 pivots
 Con passacavo | With fairlead

 Lampade
Bulbs

4 x P21W - 3 x R5W

*** Ricambio di qualità equivalente | Matching quality spare parts**

UNIVERSALE

RIMORCHI | TRAILERS

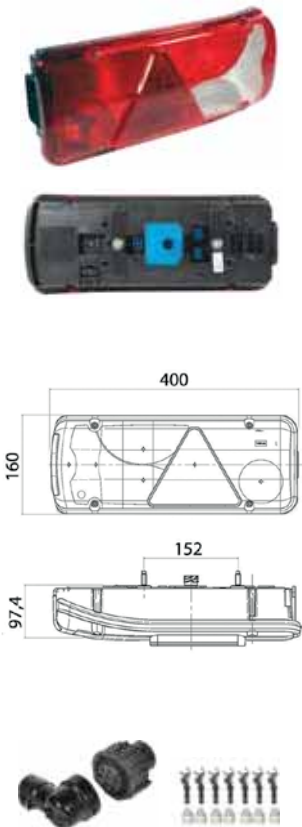

06→

| | | |
|--|--|--------------------|
| Fanale posteriore con catadiotro triangolare <i>Rear lamp with triangular reflector</i> | → | 5.44.074.00 |
| Fanale posteriore con catadiotro triangolare <i>Rear lamp with triangular reflector</i> | ← | 5.44.075.00 |
| Trasparente posteriore <i>Rear lens</i> | → | 5.44.074.20 |
| Trasparente posteriore <i>Rear lens</i> | ← | 5.44.075.20 |
| Funzioni <i>Functions</i> | 7 | |
| Servizi <i>Services</i> | Direzione / Posizione / Stop / Retromarcia / Retronebbia / Side marker / Catadiotro <i>Repeater / Parking / Stop / Reversing lamp / Rear fog lamp / Side marker / Reflector</i> | |
| Fissaggio <i>Fixing</i> | 2 perni / 2 pivots | |
| Lampade <i>Bulbs</i> | 4 x P21W - 3 x R5W | |
| Connettore <i>Connector</i> | | 3.49.070.00 |
| Attacco posteriore <i>Rear connector</i> | | |

UNIVERSALE







RIMORCHI | TRAILERS

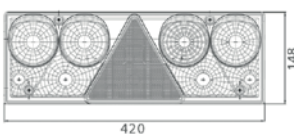

96→05

| | | |
|--|--|--------------------|
| Fanale posteriore con catadiotro triangolare <i>Rear lamp with triangular reflector</i> | → | 5.44.062.00 |
| Fanale posteriore con catadiotro triangolare <i>Rear lamp with triangular reflector</i> | ← | 5.44.063.00 |
| Trasparente posteriore <i>Rear lens</i> | → | 5.44.062.20 |
| Trasparente posteriore <i>Rear lens</i> | ← | 5.44.063.20 |
| Funzioni <i>Functions</i> | 7 | |
| Servizi <i>Services</i> | Direzione / Posizione / Stop / Retromarcia / Retronebbia / Side marker / Catadiotro <i>Repeater / Parking / Stop / Reversing lamp / Rear fog lamp / Side marker / Reflector</i> | |
| Fissaggio <i>Fixing</i> | 2 perni / 2 pivots | |
| Lampade <i>Bulbs</i> | 4 x P21W - 3 x R5W | |
| Connettore <i>Connector</i> | | 3.49.070.00 |
| Attacco posteriore <i>Rear connector</i> | | |

| UNIVERSALE | | RIMORCHI ECOPOINT | | |
|---|-----|---|--|--|
|    | 10→ | Fanale posteriore con catadiottro triangolare <i>Rear lamp with triangular reflector</i> |  7.44.060.00 | |
| | | Fanale posteriore con catadiottro triangolare <i>Rear lamp with triangular reflector</i> |  7.44.061.00 | |
| | | Trasparente posteriore <i>Rear lens</i> |  7.44.060.20 | |
| | | Trasparente posteriore <i>Rear lens</i> |  7.44.061.20 | |
| | | Funzioni <i>Functions</i> | 7 | |
| | | Servizi <i>Services</i> | Direzione / Posizione / Stop/ Retromarcia /Retronebbia / Side marker / Catadiottro <i>Repeater / Parking / Stop / Reversing lamp /Rear fog lamp / Side marker / Reflector</i> | |
| | | Fissaggio <i>Fixing</i> | 2 perni / 2 pivots | |
| | | Lampade <i>Bulbs</i> | 4 x P21W - 3 x R5W | |
| Connettore <i>Connector</i> | | | 3.49.080.00 | |

| UNIVERSALE | | RIMORCHI TRAILERS | | |
|--|--|--|--|--|
|     | | Fanale posteriore Europoint II <i>Rear lamp Europoint II</i> |  7.44.050.00 | |
| | | Fanale posteriore Europoint II <i>Rear lamp Europoint II</i> |  7.44.051.00 | |
| | | Trasparente posteriore Europoint II <i>Rear lens Europoint II</i> |   7.44.050.20 | |
| | | Funzioni <i>Functions</i> | 7 | |
| | | Servizi <i>Services</i> | Direzione / Posizione / Stop / Retromarcia /Retronebbia / Side marker <i>Repeater / Parking / Stop / Reversing lamp / Rear fog lamp / Side marker</i> | |
| | | Fissaggio <i>Fixing</i> | 2 perni / 2 pivots | |
| | | Lampade <i>Bulbs</i> | 4 x P21W - 3 x R5W | |
| | | Connettore <i>Connector</i> | | |

UNIVERSALE

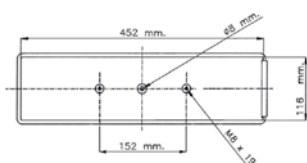

94→01

RIMORCHI | TRAILERS

Fanale posteriore Europoint II
Rear lamp Europoint II



7.44.054.00

Fanale posteriore Europoint II
Rear lamp Europoint II



7.44.055.00

Trasparente posteriore Europoint II
Rear lens Europoint II



7.44.054.20

Funzioni
Functions

7

Servizi
Services

Direzione / Posizione / Stop / Retromarcia / Retronebbia / Side marker
Repeater / Parking / Stop / Reversing lamp / Rear fog lamp / Side marker

Fissaggio
Fixing

2 perni / 2 pivots

Lampade
Bulbs

4 x P21W - 3 x R5W

UNIVERSALE

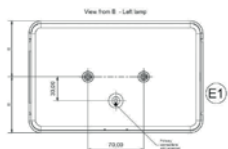

RIMORCHI | TRAILERS

Fanale posteriore con luce targa e retromarcia
Rear lamp with number plate light and reversing lamp



2.44.226.00

Fanale posteriore con luce targa e retronebbia
Rear lamp with number plate light and rear fog lamp



2.44.227.00

Trasparente posteriore con retromarcia
Rear lens with reversing lamp



2.44.226.20

Trasparente posteriore con retronebbia
Rear lens with rear fog lamp



2.44.227.20

Funzioni
Functions

5

Servizi
Services

Direzione / Posizione / Stop / Retromarcia / Retronebbia / Side marker
Repeater / Parking / Stop / Reversing lamp / Rear fog lamp / Side marker

Fissaggio
Fixing

2 perni / 2 pivots

Dimensioni mm. 200x140 | Interasse 55 mm.

Dimension mm. 200x140 | Interaxis distance 55 mm.

*** Ricambio di qualità equivalente | Matching quality spare parts**

UNIVERSALE
RIMORCHI | TRAILERS

Fanale posteriore con retromarcia
Rear lamp with reversing lamp

2.44.320.00

Trasparente posteriore con retromarcia
Rear lens with reversing lamp

2.44.320.20

Funzioni
Functions

5

Servizi
Services

Direzione / Posizione / Stop / Retromarcia / Catadiottero
Repeater / Parking / Stop / Reversing lamp / Reflector

12V | Dimensioni mm. 210x140x60

12V | Dimension mm. 210x140x60

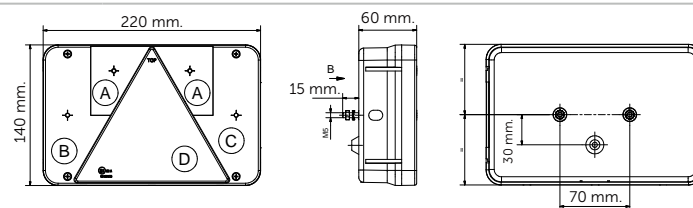

*** Ricambio di qualità equivalente | Matching quality spare parts**

UNIVERSALE
RIMORCHI | TRAILERS

Fanale posteriore con retromarcia
Rear reverse lamp

2.44.298.00

Fanale posteriore con retromarcia
Rear reverse lamp

2.44.299.00

Trasparente posteriore
Rear lens

2.44.298.20

Trasparente posteriore
Rear lens

2.44.299.20

Funzioni
Functions

5



Lampade
Bulbs



R5W+P21W

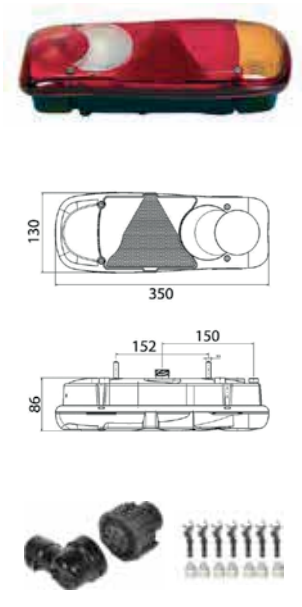

Con passacavo | *With fairlead*

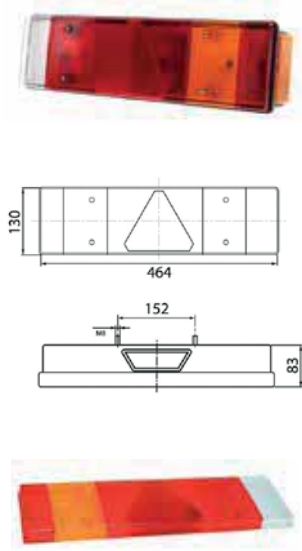

*** Ricambio di qualità equivalente | Matching quality spare parts**



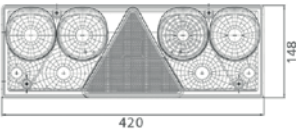

| UNIVERSALE | | RIMORCHI | | LED |
|---|---------------------------------------|---|--------------------|-----|
|  | Fanale posteriore <i>Rear lamp</i> | ➔ | 7.44.098.80 | |
| | | ➔ | 7.44.099.80 | |
| | Funzioni <i>Functions</i> | 5 | | |
| | Servizi <i>Services</i> | Direzione / Posizione / Stop / Retromarcia / Retronebbia / Side marker <i>Repeater / Parking / Stop / Reversing lamp / Rear fog lamp / Side marker</i> | | |
| | Fissaggio <i>Fixing</i> | 2 perni / 2 pivots | | |
| 12-24V Cavo mm. 500 / Cable mm. 500 | | | | |

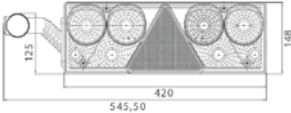



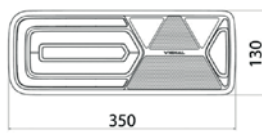

| UNIVERSALE | | RIMORCHI | | |
|--|---|----------|--------------------|--|
|  | Fanale posteriore <i>Rear lamp</i> | ➔ | 5.44.126.00 | |
| | Fanale posteriore <i>Rear lamp</i> | ➔ | 5.44.127.00 | |
| | Trasparente posteriore <i>Rear lens</i> | ➔ | 5.44.126.20 | |
| | Trasparente posteriore <i>Rear lens</i> | ➔ | 5.44.127.20 | |
| | Connettore / Connector AMP 1,5 | | 3.49.070.00 | |
| |  | | | |

| UNIVERSALE | | RIMORCHI | | |
|---|--|----------|---|--|
|  | Fanale posteriore <i>Rear lamp</i> | ➔ | 5.44.128.00 | |
| | Fanale posteriore <i>Rear lamp</i> | ➔ | 5.44.129.00 | |
| | Trasparente posteriore <i>Rear lens</i> | ➔ | 5.44.128.20 | |
| | Trasparente posteriore <i>Rear lens</i> | ➔ | 5.44.129.20 | |
| | Con passacavo / With fairlead | |  | |

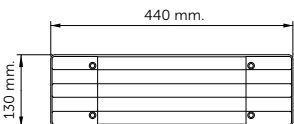
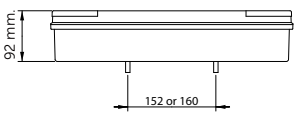











| UNIVERSALE | | SCHMITZ | |
|--|--|--|--------------------|
|    | Fanale posteriore rimorchi <i>Rear lamp trailer</i> | → | 7.44.056.00 |
| | Fanale posteriore rimorchi <i>Rear lamp trailer</i> | ← | 7.44.057.00 |
| | Trasparente posteriore <i>Rear lens</i> | → ← | 7.44.050.20 |
| | Funzioni <i>Functions</i> | 7 | |
| | Servizi <i>Services</i> | Direzione / Posizione / Stop / Retromarcia /Retronebbia / Side marker <i>Repeater / Parking / Stop / Reversing lamp / Rear fog lamp / Side marker</i> | |
| | Fissaggio <i>Fixing</i> | 2 perni / 2 pivots | |
| Lampade <i>Bulbs</i> | 4 x P21W - 3 x R5W | | |
| Connettore <i>Connector</i> | | | 3.49.080.00 |

| UNIVERSALE | | SCHMITZ | |
|---|--|--|--------------------|
|    | Fanale posteriore rimorchi <i>Rear lamp trailer</i> | → | 7.44.058.00 |
| | Fanale posteriore rimorchi <i>Rear lamp trailer</i> | ← | 7.44.059.00 |
| | Trasparente posteriore <i>Rear lens</i> | → ← | 7.44.050.20 |
| | Funzioni <i>Functions</i> | 7 | |
| | Servizi <i>Services</i> | Direzione / Posizione / Stop / Retromarcia /Retronebbia / Side marker <i>Repeater / Parking / Stop / Reversing lamp / Rear fog lamp / Side marker</i> | |
| | Fissaggio <i>Fixing</i> | 2 perni / 2 pivots | |
| Lampade <i>Bulbs</i> | 4 x P21W - 3 x R5W | | |
| Connettore <i>Connector</i> | | | 3.49.080.00 |

| UNIVERSALE | SCHMITZ | LED |
|---|--|--|
|    | Fanale posteriore rimorchi con indicatore direzione dinamico <i>Rear lamp trailer with dynamic effect</i> |  5.44.120.80 |
| | Fanale posteriore rimorchi con indicatore direzione dinamico <i>Rear lamp trailer with dynamic effect</i> |  5.44.121.80 |
| | Resistenza integrata / <i>Integrated resistance</i> | |
| | 24V |  |

| UNIVERSALE | SCHMITZ KOGEL | | |
|--|--|--|--|
|     | Fanale posteriore rimorchi <i>Rear lamp trailer</i> |  2.44.190.00 | |
| | Fanale posteriore rimorchi <i>Rear lamp trailer</i> |  2.44.191.00 | |
| | Trasparente posteriore <i>Rear lens</i> |   2.44.190.20 | |
| | Funzioni <i>Functions</i> | 5 | |
| | Servizi <i>Services</i> | Direzione / Posizione / Stop / Retromarcia / Retronebbia / Side marker <i>Repeater / Parking / Stop / Reversing lamp / Rear fog lamp / Side marker</i> | |
| | Fissaggio <i>Fixing</i> | 2 perni / 2 pivots | |
| | Lampade <i>Bulbs</i> | 4 x P21W - 3 x R5W | |
| * Ricambio di qualità equivalente Matching quality spare parts | | | |

| UNIVERSALE | TRATTORI TRACTORS | |
|---|---|--------------------|
|  | Fanale posteriore <i>Rear lamp</i> | 2.44.258.00 |
| | Trasparente posteriore <i>Rear lens</i> | 2.44.258.20 |
| | * Ricambio di qualità equivalente Matching quality spare parts | |

| FIAT | | DUCATO MY 2006 | | |
|---|-------|--|--|--------------------|
|  | | Briglia adattore con motorino <i>Adapter with device</i> | | 8.40.088.19 |
| | | | | |
| IVECO | | 115/17 - 135/17 - 145/17 | | |
|  | 89→ | Gruppo ottico (H4) manuale <i>Optical unit (H4) manual</i> |   | 8.40.100.00 |
| | | * Ricambio di qualità equivalente Matching quality spare parts | | |
| IVECO | | DAILY OM GRINTA | | |
|  | 78→ | Proiettore (H4) <i>Headlamp (H4)</i> |   | 8.40.086.00 |
| | | * Ricambio di qualità equivalente Matching quality spare parts | | |
| IVECO | | DAILY 2000 | | |
|  | | Proiettore (H1+H7) completo di motorino <i>Headlamp (H1+H7) with device</i> |  | 8.40.066.00 |
| | 00→06 | Proiettore (H1+H7) completo di motorino <i>Headlamp (H1+H7) with device</i> |  | 8.40.067.00 |
| | | | | |
| IVECO | | DAILY | | |
|  | | Proiettore (2 H1+H7) completo di motorino <i>Headlamp (2 H1+H7) with device</i> |  | 8.40.060.00 |
| | 06→ | Proiettore (2 H1+H7) completo di motorino <i>Headlamp (2 H1+H7) with device</i> |  | 8.40.061.00 |
| | | | | |







| IVECO | | DAILY | |
|---|-----|--|----------------------|
|  | 11→ | Proiettore (H7+H1) completo di motorino <i>Headlamp (H7+H1) with device</i> | ➔ 8.40.090.00 |
| | | Proiettore (H7+H1) completo di motorino <i>Headlamp (H7+H1) with device</i> | ➚ 8.40.091.00 |
| | | | |





| IVECO | | EUROTRAKKER | |
|---|-----|--|----------------------|
|  | 03→ | Proiettore (H4) predisposto correttore elettrico <i>Headlamp (H4) fitted for electric</i> | ➔ 8.40.092.00 |
| | | Proiettore (H4) predisposto correttore elettrico <i>Headlamp (H4) fitted for electric</i> | ➚ 8.40.093.00 |
| | | | |

| IVECO | | SERIE Z | |
|---|---|---|----------------------|
|  | 87→ | Proiettore (H4) <i>Headlamp (H4)</i> | ➔ 8.40.070.00 |
| | | Proiettore (H4) <i>Headlamp (H4)</i> | ➚ 8.40.071.00 |
| | * Ricambio di qualità equivalente Matching quality spare parts | | |

| IVECO | | STRALIS | |
|---|-------|--|----------------------|
|  | 02→07 | Proiettore (H7+H7) completo di motorino <i>Headlamp (H7+H7) with device</i> | ➔ 8.40.042.00 |
| | | Proiettore (H7+H7) completo di motorino <i>Headlamp (H7+H7) with device</i> | ➚ 8.40.043.00 |
| | | | |

| NISSAN | | CABSTAR | |
|---|-------|--|----------------------|
|  | 01→06 | Proiettore (H4) completo di motorino <i>Headlamp (H4) with device</i> | ➔ 8.40.076.00 |
| | | Proiettore (H4) completo di motorino <i>Headlamp (H4) with device</i> | ➚ 8.40.077.00 |
| | | | |

| NISSAN | | CABSTAR | | |
|---|-----|---|--|-------|
|  | 08→ | Proiettore (HB4+HB4) completo di motorino - con cornice incolore <i>Headlamp (HB4+HB4) with device - clear frame</i> |  8.40.080.00 | |
| | | Proiettore (HB4+HB4) completo di motorino - con cornice incolore <i>Headlamp (HB4+HB4) with device - clear frame</i> |  8.40.081.00 | |
| RENAULT | | RANGE T | | XENON |
|  | 14→ | Proiettore completo di lampada (H1-D1S) con centralina con DRL led <i>Headlamp with bulb (H1-D1S) and control unit led DRL</i> |  8.40.108.60 | |
| | | Proiettore completo di lampada (H1-D1S) con centralina con DRL led <i>Headlamp with bulb (H1-D1S) and control unit led DRL</i> |  8.40.109.60 | |

















| FIAT | | DUCATO | | |
|---|-------|---|---|--------------------|
|  | 02→ | Fendinebbia (H1) Fog lamp (H1) | ↔ | 8.20.054.00 |
| | | Staffa grigia / Grey bracket | | |
| IVECO | | DAILY 2014 | | |
|  | 14→ | Fendinebbia (H1) Fog lamp (H1) | ↔ | 8.20.100.00 |
| | | Portalampada (H1) / Bulb holder (H1) | | 3.49.092.00 |
| IVECO | | STRALIS | | |
|  | 02→07 | Fendinebbia (H1) Fog lamp (H1) | ↔ | 8.50.054.00 |
| | | | | |
| IVECO | | STRALIS | | |
|  | 02→07 | Fendinebbia (H1) Fog lamp (H1) | ↔ | 8.50.056.00 |
| | | | | |
| IVECO | | STRALIS | | |
|  | 07→ | Fendinebbia (H1) Fog lamp (H1) | ↔ | 8.50.058.00 |
| | | * Ricambio di qualità equivalente Matching quality spare parts | | |

| IVECO | | STRALIS | | |
|---|-----|--|---|--------------------|
|  | 07→ | Proiettore profondità (H1) Long beam (H1) | ↔ | 8.50.060.00 |
| | | * Ricambio di qualità equivalente Matching quality spare parts | | |



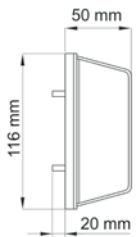
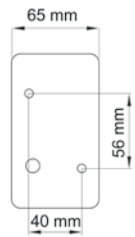

| IVECO | | STRALIS | | |
|---|-------|--|---|--------------------|
|  | 07→12 | Mascherina fendinebbia Fog lamp grill | → | 8.50.058.17 |
| | | Mascherina fendinebbia Fog lamp grill | ← | 8.50.059.17 |
| | | * Ricambio di qualità equivalente Matching quality spare parts | | |





| MAN | | 2000 EVOLUTION TG TGL TGM | | |
|---|-----|--|---|--------------------|
|  | 98→ | Fendinebbia Fog lamp | → | 8.50.062.00 |
| | | Fendinebbia Fog lamp | ← | 8.50.063.00 |
| | | * Ricambio di qualità equivalente Matching quality spare parts | | |



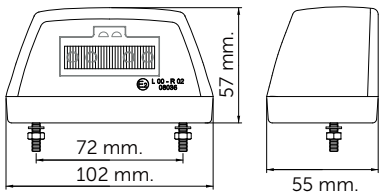

| MAN | | 2000 EVOLUTION TG TGL TGM | | |
|---|-----|--|---|--------------------|
|  | 98→ | Fendinebbia Fog lamp | → | 8.50.064.00 |
| | | Fendinebbia Fog lamp | ← | 8.50.065.00 |
| | | * Ricambio di qualità equivalente Matching quality spare parts | | |

| FIAT | | DUCATO | | | |
|---|-------|---|--|--------------------|--|
|  | 93→01 | Fanale targa Number plate light |   | 1.45.054.00 | |
| | | | | | |
| FIAT | | DUCATO | | | |
|  | 02→ | Fanale targa Number plate light |   | 1.45.064.00 | |
| | | | | | |
| FIAT | | DUCATO | | | |
|  | 11→ | Fanale targa Number plate light |   | 1.45.068.00 | |
| | | | | | |
| FIAT | | SCUDO | | | |
|  | 95→ | Fanale targa Number plate light |   | 1.45.062.00 | |
| | | | | | |
| FIAT IVECO | | UNIVERSALE | | | |
|    | | Fanale luce targa Number plate light |  | 2.45.050.00 | |
| | | Fanale luce targa Number plate light |  | 2.45.051.00 | |
| | | Fanale luce targa Number plate light |  | 2.45.052.00 | |
| | | Fanale luce targa Number plate light |  | 2.45.053.00 | |
| | | * Ricambio di qualità equivalente Matching quality spare parts | | | |

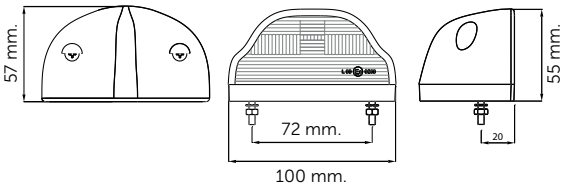
| IVECO | | DAILY | | |
|--|--|--|---|--------------------|
|  | 06→ | Fanale luce targa Number plate light |   | 1.45.066.00 |
| | | | | |
| IVECO | | IRISBUS | | |
|  | | Fanale luce targa Number plate light |   | 1.45.050.00 |
| | | | | |
| RENAULT OPEL | | MASTER MOVANO | | |
|  | 99→ | Fanale luce targa Number plate light |   | 1.45.060.00 |
| | | | | |
| UNIVERSALE | | | | |
|  | | Fanale luce targa Number plate light |   | 2.45.054.00 |
| | |  | | |
| | | * Ricambio di qualità equivalente Matching quality spare parts | | |
| UNIVERSALE | | | | |
|   | | Fanale luce targa nero Black number plate light |   | 2.45.056.00 |
| | | Fanale luce targa rosso Red number plate light |   | 2.45.058.00 |
| | |  | | |
| | * Ricambio di qualità equivalente Matching quality spare parts | | | |

| UNIVERSALE | | LED | |
|---|---|--|--------------------|
|  | Fanale luce targa nero <i>Black number plate light</i> |   | 2.45.062.00 |
| | Fanale luce targa con luce di posizione rosso <i>Red number plate light with parking light</i> |   | 2.45.060.00 |
| 6 led 24V | | | |
|  | | | |
| * Ricambio di qualità equivalente Matching quality spare parts | | | |

| UNIVERSALE | | | |
|--|---|--|--------------------|
|  | Fanale luce targa rosso <i>Red number plate light</i> |   | 7.45.052.00 |
| | Fanale luce targa nero <i>Black number plate light</i> |   | 2.45.066.00 |
|  | | | |

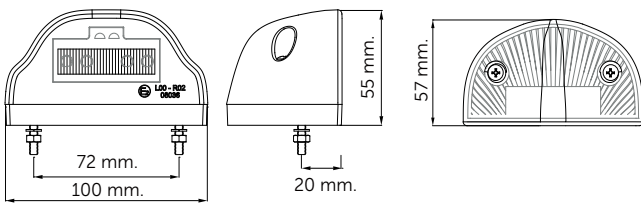
| UNIVERSALE | RIMORCHI MOTRICE | LED | |
|--|---|--|--------------------|
|  | Fanale luce targa rosso <i>Red number plate light</i> |   | 2.45.070.80 |
| | Fanale luce targa nero <i>Black number plate light</i> |   | 2.45.072.80 |
| 24V | | | |
|  | | | |
| * Ricambio di qualità equivalente Matching quality spare parts | | | |

| UNIVERSALE | RIMORCHI MOTRICE | LED |
|---|--|------------------------------------|
|  | <p>Fanale luce targa nero <i>Black number plate light</i></p> <p>24V</p>  <p>* Ricambio di qualità equivalente Matching quality spare parts</p> | <p>↔</p> <p>2.45.068.80</p> |
|  | <p>Fanale luce targa <i>Number plate light</i></p> <p>* Ricambio di qualità equivalente Matching quality spare parts</p> | <p>↔</p> <p>2.45.064.00</p> |
|  | <p>Fanale luce targa <i>Number plate light</i></p> <p>4 led 24V</p> <p>* Ricambio di qualità equivalente Matching quality spare parts</p> | <p>↔</p> <p>2.45.074.80</p> |
|  | <p>Fanale luce targa <i>Number plate light</i></p>  <p>* Ricambio di qualità equivalente Matching quality spare parts</p> | <p>↔</p> <p>2.45.076.00</p> |

UNIVERSALE

LED



Fanale luce targa
Number plate light



2.45.078.80

12-24V

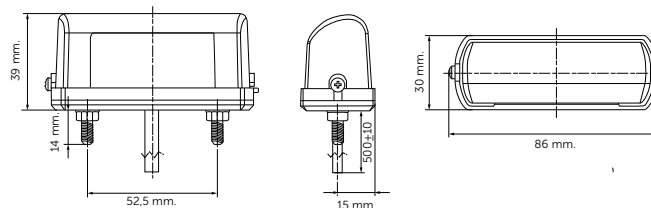

* Ricambio di qualità equivalente | Matching quality spare parts

UNIVERSALE







Scatola derivazione 170x110x73 mm.
Branch box 170x110x73 mm.



2.44.234.00

8 connettori | 8 connectors



| FIAT | | DUCATO | |
|---|-----|---|--------------------|
|  | 94→ | Catadiottro <i>Reflector</i> | 1.46.052.00 |
| | | | |
| RENAULT OPEL | | MASTER MOVANO | |
|  | 99→ | Catadiottro <i>Reflector</i> | 1.46.050.00 |
| | | | |
| UNIVERSALE | | Ø 60 mm. | |
|  | | Catadiottro rosso con foro di fissaggio <i>Red reflector with fixing hole</i> | 4.46.058.90 |
| | | Catadiottro arancio con foro di fissaggio <i>Orange reflector with fixing hole</i> | 4.46.058.91 |
| | | Catadiottro incolore con foro di fissaggio <i>Clear reflector with fixing hole</i> | 4.46.058.92 |
| | | * Articolo universale Universal part | |
| UNIVERSALE | | Ø 60 mm. | |
|  | | Catadiottro rosso con base adesiva <i>Red reflector with adhesive base</i> | 4.46.062.90 |
| | | Catadiottro arancio con base adesiva <i>Orange reflector with adhesive base</i> | 4.46.062.91 |
| | | Catadiottro incolore con base adesiva <i>Clear reflector with adhesive base</i> | 4.46.062.92 |
| | | * Articolo universale Universal part | |

| UNIVERSALE | Ø 60 mm. | |
|---|--|--------------------|
|  | Catadriotto rosso con perno di fissaggio <i>Red reflector with fixing hole</i> | 4.46.054.90 |
| | Catadriotto arancio con perno di fissaggio <i>Orange reflector with fixing hole</i> | 4.46.054.91 |
| | Catadriotto incolore con perno di fissaggio <i>Clear reflector with fixing hole</i> | 4.46.054.92 |
| | * Articolo universale Universal part | |

| UNIVERSALE | Ø 80 mm. | |
|--|--|--------------------|
|  | Catadriotto rosso con base adesiva <i>Red reflector with adhesive base</i> | 4.46.064.90 |
| | Catadriotto arancio con base adesiva <i>Orange reflector with adhesive base</i> | 4.46.064.91 |
| | Catadriotto incolore con base adesiva <i>Clear reflector with adhesive base</i> | 4.46.064.92 |
| | * Articolo universale Universal part | |

| UNIVERSALE | Ø 80 mm. | |
|---|--|--------------------|
|  | Catadriotto rosso con perno di fissaggio <i>Red reflector with fixing hole</i> | 4.46.056.90 |
| | Catadriotto arancio con perno di fissaggio <i>Orange reflector with fixing hole</i> | 4.46.056.91 |
| | Catadriotto incolore con perno di fissaggio <i>Clear reflector with fixing hole</i> | 4.46.056.92 |
| | * Articolo universale Universal part | |

| UNIVERSALE | | 103 X 51 mm. | |
|---|---|--|--------------------|
|  | | Catadriotto rosso con base adesiva <i>Red reflector with adhesive base</i> | 4.46.068.90 |
| | | Catadriotto arancio con base adesiva <i>Orange reflector with adhesive base</i> | 4.46.068.91 |
| | | Catadriotto incolore con base adesiva <i>Clear reflector with adhesive base</i> | 4.46.068.92 |
| | * Articolo universale Universal part | | |

| UNIVERSALE | | 127 X 51 mm. | |
|--|---|---|--------------------|
|  | | Catadriotto rosso con foro di fissaggio <i>Red reflector with fixing hole</i> | 4.46.070.90 |
| | | Catadriotto arancio con foro di fissaggio <i>Orange reflector with fixing hole</i> | 4.46.070.91 |
| | | Catadriotto incolore con foro di fissaggio <i>Clear reflector with fixing hole</i> | 4.46.070.92 |
| | * Articolo universale Universal part | | |

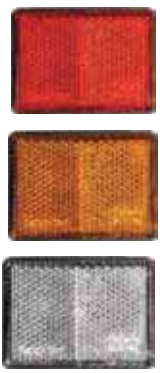
| UNIVERSALE | | 63 X 51 mm. | |
|---|---|--|--------------------|
|  | | Catadriotto rosso con base adesiva <i>Red reflector with adhesive base</i> | 4.46.066.90 |
| | | Catadriotto arancio con base adesiva <i>Orange reflector with adhesive base</i> | 4.46.066.91 |
| | | Catadriotto incolore con base adesiva <i>Clear reflector with adhesive base</i> | 4.46.066.92 |
| | * Articolo universale Universal part | | |

| UNIVERSALE | | RIMORCHI TRAILERS | |
|---|---|--|--------------------|
|  | | Catadriotto rosso con 2 perni <i>Red reflector with 2 holes</i> | 4.46.072.90 |
| | * Articolo universale Universal part | | |

| UNIVERSALE | RIMORCHI TRAILERS | |
|---|---|---------------------------|
|  | <p>Catadriotto rosso con 2 fori <i>Red reflector with 2 fixing holes</i></p> <p>Interasse 70 mm. <i>Interaxis distance 70 mm.</i></p> | <p>4.46.074.90</p> |
| | <p>* Articolo universale Universal part</p> | |

| UNIVERSALE | RIMORCHI TRAILERS | |
|---|---|---------------------------|
|  | <p>Catadriotto rosso con 2 fori <i>Red reflector with 2 fixing holes</i></p> <p>Interasse 85 mm. <i>Interaxis distance 85 mm.</i></p> | <p>4.46.076.90</p> |
| | <p>* Articolo universale Universal part</p> | |

| FIAT | | DUCATO | | | |
|---|-----|--|--------------------|-----|--|
|  | 94→ | Plafoniera <i>Dome lamp</i> | 1.48.058.00 | | |
| | | Grigio 670 Grey 670 | | | |
| IVECO | | | | | |
|  | 94→ | Plafoniera <i>Dome lamp</i> | 1.48.060.00 | | |
| | | Nera Black | | | |
| IVECO | | VARIOUS | | LED | |
|  | 13→ | Plafoniera interna nera <i>Internal black dome lamp</i> | 1.48.060.80 | | |
| | | 12V | | | |
| UNIVERSALE | | AUTOBUS | | LED | |
|  | | Plafoniera <i>Dome lamp</i> | 2.48.050.80 | | |
| | | Plafoniera <i>Dome lamp</i> | 2.48.052.80 | | |
| | | 34 led 12V Dimensioni 135x70 mm. - Accensione a tatto Dimension 135x70 mm. - Touch button | | | |
| | | * Ricambio di qualità equivalente Matching quality spare parts | | | |
| UNIVERSALE | | BUS | | LED | |
|  | | Plafoniera incolore 12V <i>12V Clear dome lamp</i> | 2.48.058.80 | | |
| | | Plafoniera incolore 24V <i>24V Clear dome lamp</i> | 2.48.060.80 | | |
| | | * Ricambio di qualità equivalente Matching quality spare parts | | | |

| UNIVERSALE | | LED |
|---|---|--------------------|
|  | Plafoniera <i>Dome lamp</i> | 2.48.062.80 |
| | 6 led 24V Ø 550 mm. | |
| | * Ricambio di qualità equivalente <i>Matching quality spare parts</i> | |

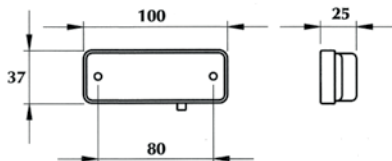
| UNIVERSALE | | |
|---|--|--------------------|
|  | Plafoniera con lente bianca e con interruttore <i>Dome lamp with clear lens and with switch</i> | 2.48.066.00 |
| |  | |
| | * Ricambio di qualità equivalente <i>Matching quality spare parts</i> | |

| UNIVERSALE | | |
|---|--------------------------------|---------------------|
|  | Plafoniera <i>Dome lamp</i> | B08.839.908D |
| | Nera <i>Black</i> | |
| | 12V 5W | |

| UNIVERSALE | | |
|---|--------------------------------|--------------------|
|  | Plafoniera <i>Dome lamp</i> | B08.896.004 |
| | | |

UNIVERSALE

Lampada rotante
Revolving beacom

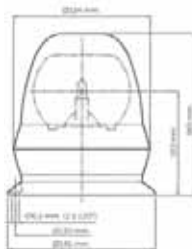

2.47.050.00

Calotta
Cover

2.47.050.23

12-24v
Fissaggio a vite | *Screw fixing*

UNIVERSALE

Lampada rotante blu
Blue revolving beacom

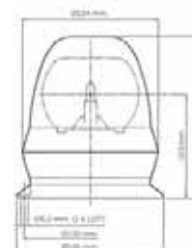

2.47.051.00

12-24v
Fissaggio a vite | *Screw fixing*

UNIVERSALE
LED

Lampada rotante
Revolving beacom

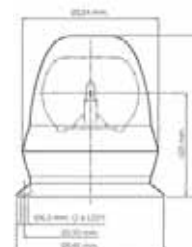

2.47.050.80

12-24V
Fissaggio a vite / *Screw fixing*

UNIVERSALE

Lampada rotante
Revolving beacom

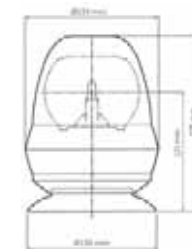



2.47.052.00

Calotta
Cover

2.47.050.23

12-24v
Fissaggio a base magnetica | *Magnetic base fixing*



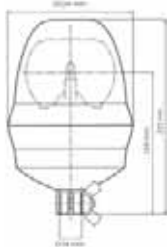

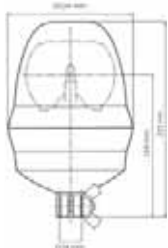
| UNIVERSALE | | LED | |
|---|--|--|--------------------|
|  | Lampada rotante <i>Revolving beacon</i> |  | 2.47.052.80 |
| | 12-24v Fissaggio a base magnetica <i>Magnetic base fixing</i> | | |

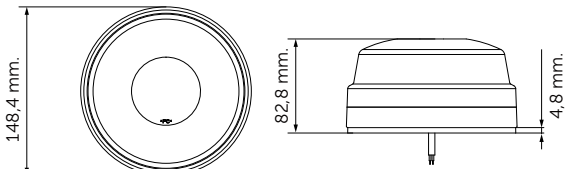
| UNIVERSALE | | | |
|---|--|--|--------------------|
|  | Lampada rotante <i>Revolving beacon</i> |  | 2.47.054.00 |
| | Calotta <i>Cover</i> | | 2.47.050.23 |
| 12-24v Fissaggio a piantone ISO <i>Column fixing standard ISO</i> | | | |

| UNIVERSALE | | LED | |
|---|---|--|--------------------|
|  | Lampada rotante <i>Revolving beacon</i> |  | 2.47.054.80 |
| | 12-24v Fissaggio a piantone <i>Column fixing</i> | | |

| UNIVERSALE | | LED | |
|---|---|-----|--------------------|
|  | Lampada rotante arancio <i>Orange revolving beacon</i> | | 2.47.098.80 |
| | 10-30v Fissaggio 3 viti / <i>3 screws fixing</i> Potenza assorbita / <i>Absorbed power: 11 W</i> | | |
| |  | | |
| * Articolo universale <i>Universal part</i> | | | |

| UNIVERSALE | | LED |
|---|---|--------------------|
|  | Lampada rotante arancio <i>Orange revolving beacon</i> | 2.47.100.80 |
| | 10-30V Base magnetica / <i>Magnetic base</i> Cavo spiralato m 3 / <i>m 3 spiral cable</i> Spinotto accendino / <i>Lighter plug</i> | |
| |  | |
| | * Articolo universale Universal part | |
| UNIVERSALE | | LED |
|  | Lampada rotante arancio <i>Orange revolving beacon</i> | 2.47.102.80 |
| | 10-30V Base flessibile per fissaggio innesto tubolare / <i>Flexible base for tube plug</i> Potenza assorbita 11 W / <i>Absorbed power: 11 W</i> | |
| |  | |
| | * Articolo universale Universal part | |
| UNIVERSALE | | LED |
|  | Lampada rotante magnetica <i>Magnetic base revolving beacon</i> | 2.47.104.80 |
| | 12-24V Ø 62,5 mm. x 53,4 mm. | |
| | * Articolo universale Universal part | |
| UNIVERSALE | | LED |
|  | Lampada rotante fissaggio a tubo <i>Tube plug revolving beacon</i> | 2.47.106.80 |
| | 12-24V Ø 62,5 mm. x 53,4 mm. | |
| | * Articolo universale Universal part | |

| UNIVERSALE | | | LED |
|---|--|--|--------------------|
|  | | Lampada rotante fissaggio a vite <i>Screw fixing revolving beacon</i> | 2.47.108.80 |
| | | 12-24V Ø 62,5 mm. x 53,4 mm. | |
| | | * Articolo universale Universal part | |
| UNIVERSALE | | | LED |
|  | | Lampada rotante fissaggio a vite <i>Screw fixing revolving beacon</i> | 5.47.050.80 |
| | | 10-30V Fissaggio 3 viti 3 screws fixing Potenza assorbita Absorbed power: 11 W | |
| | | Direttiva ECE R/65 - /R/10 | |
| UNIVERSALE | | | LED |
|  | | Lampada rotante base magnetica <i>Magnetic base revolving beacon</i> | 5.47.051.80 |
| | | 10-30V Base magnetica / Magnetic base Fissaggio 3 viti / 3 screws fixing Cavo spiralato m 3 / m 3 spiral cable Spinotto accendino / Lighter plug | |
| | | Direttiva ECE R/65 - /R/10 | |
| UNIVERSALE | | | LED |
|  | | Lampada rotante piantone <i>Column fixing revolving beacon</i> | 5.47.052.80 |
| | | 10-30V Base flessibile per fissaggio innesto tubolare / Flexible base for tube plug Potenza assorbita Absorbed power: 11 W | |
| | | Direttiva ECE R/65 - /R/10 | |

UNIVERSALE
LED

Lampada rotante luce arancio
Orange light revolving beacon

2.47.068.00

10-30V
Fissaggio 3 viti / *3 screws fixing*
Potenza assorbita da 14W a 28W / *Power consumption from 14W to 28W*
Calotta in policarbonato trasparente / *Clear polycarbonate cover*

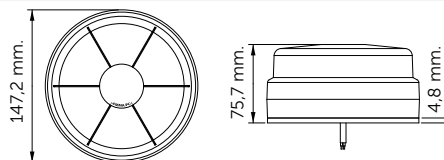

12 LEDs Hight Power STD

UNIVERSALE
LED



Lampada rotante luce arancio
Orange light revolving beacon

2.47.072.00

Lampada rotante luce blu
Blue light revolving beacon

2.47.074.00

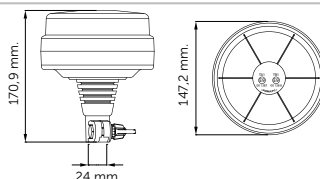
10-30V
Base per fissaggio innesto tubolare / *Base for fitting plug tube*
Potenza assorbita da 14W a 28W / *Power consumption from 14W to 28W*
Calotta in policarbonato trasparente / *Clear polycarbonate cover*



12 LEDs Hight Power STD

UNIVERSALE
LED



Lampada rotante luce arancio
Orange light revolving beacon

2.47.076.00

Lampada rotante luce blu
Blue light revolving beacon

2.47.078.00

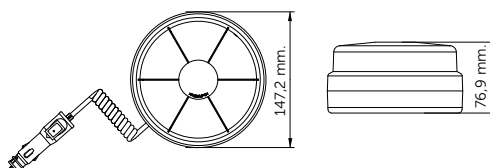
10-30V
Base magnetica / *Magnetic Base* | Attacco a tubo / *Fitting plug tube*
Cavo spiralato lungo 3 metri | *3 MT. long caled cable*
Spinotto accendino | *Lighter plug*
Potenza assorbita da 14W a 28W | *Power consumption from 14W to 28W*
Calotta in policarbonato trasparente | *Clear polycarbonate cover*



12 LEDs Hight Power STD



UNIVERSALE



Portalampane connettore AMP 2 vie con cavo
Bulb holder AMP 2 connector with cable

1.09.051.50

UNIVERSALE



Portalampane per H1
H1 bulb holder

3.49.092.00

* **Articolo universale | Universal part**

UNIVERSALE



Cavo spiralato
Coiled cable

3.49.063.00

UNIVERSALE



Perno filettato
Threaded pivots

3.49.064.00

UNIVERSALE



Spinotto accendino
Lighter-plug

3.49.066.00

UNIVERSALE

Segnalatore acustico universale - 10/30 Vcc
Universal acoustic signal - 10/30 Vcc

3.49.052.00

Segnalatore acustico universale - 30/120 CC
Universal acoustic signal - 30/120 CC

3.49.054.00
UNIVERSALE

Portalampane di metallo per lampada BA9S
Metal bulb holder for BA9S bulb

3.49.075.00

Cavo 200 metri | *200 mt. cable*

UNIVERSALE

Corpetto omologato arancio EN471 classe 2
Class 2 EN471 approved orange vest

4.46.79.57
UNIVERSALE

Smorzatore vibrazioni
Silent block

3.49.050.00

UNIVERSALE

Segnalatore acustico universale
Universal acoustic signal

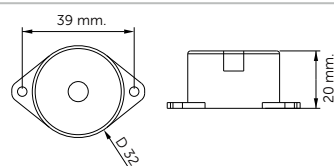
3.49.084.00

9/33 Vcc | 70 DB

UNIVERSALE



Segnalatore acustico universale -
Universal acoustic signal

3.49.086.00

9/33 Vcc | 88 DB

UNIVERSALE



Connettore AMP 2 vie | *2 ways AMP connector*
Cuffia in gomma | *Rubber cap*

3.49.056.00

Connettore AMP 3 vie | *3 ways AMP connector*
Cuffia in gomma | *Rubber cap*

3.49.057.00

Kit con 2 pezzi | *Kit with 2 female connectors*

UNIVERSALE



Connettore AMP 2 vie | *2 ways AMP connector*
Con cavo 500 mm. e cuffia in gomma
With mm. 500 cable and rubber cap

3.49.056.50

Connettore AMP 3 vie | *3 ways AMP connector*
Con cavo 500 mm. e cuffia in gomma
With mm. 500 cable and rubber cap

3.49.057.50

UNIVERSALE



Connettore a 1 scanalatura
Connector at 1 groove

3.49.073.50

IVECO | UNIVERSALE



Connettore femmina 10 vie
10 ways female connector

3.49.058.00

Kit con 1 pezzo | *Kit with 4 female connectors*

IVECO | UNIVERSALE

Connettore femmina 3 vie
3 ways female connector

3.49.060.00

Kit con 2 pezzi | *Kit with 2 female connectors*

IVECO | UNIVERSALE

Connettore
Connector

3.49.070.00



Connettore
Connector

3.49.071.00

UNIVERSALE

Connettore
Connector

3.49.080.00

Per fanale | *For lamp 2.44.068.00 - 2.44.069.00*

UNIVERSALE

Connettore per fanali posteriori Aspock
Connector for rear lamps



3.49.094.00



Connettore per fanali posteriori Aspock
Connector for rear lamps



3.49.095.00

UNIVERSALE

Raccordo (Ghiera M42x1,5)
Nipple (Plastic ring M42x1,5)

6.49.052.00

Raccordo (Ghiera M28x1,5)
Nipple (Plastic ring M28x1,5)

6.49.054.00

UNIVERSALE



Raccordo (ghiera M45x1,5)
Nipple (plastic ring M45x1.5)

6.49.055.00

UNIVERSALE

LED



Faro lavoro
Working lamp

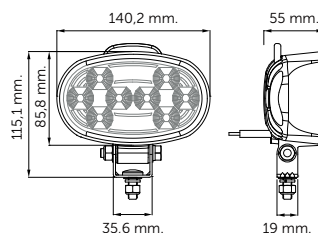

3.47.058.00

Flusso luminoso 1200 Lumen / Luminous flux 1200 Lumen

8 led | 3W | 10-30V DC

* **Articolo universale | Universal part**

UNIVERSALE

LED



Faro lavoro
Working lamp

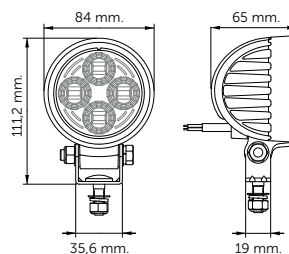

3.47.062.00

4 led | 2W | 10-30V DC



* **Articolo universale | Universal part**

UNIVERSALE

LED



Faro lavoro
Working lamp

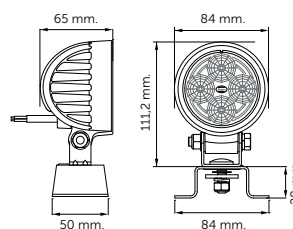

3.47.064.00

Flusso luminoso 600 Lumen / Luminous flux 600 Lumen

4 led | 9W | 10-30V DC



* **Articolo universale | Universal part**







| UNIVERSALE | | LED | |
|---|---|-----|--------------------|
|  | Faro lavoro Ø 116 mm. <i>Working lamp Ø 116 mm.</i> | | 3.47.072.80 |
| | 9 led 3W Voltaggio <i>Voltage:</i> 10-30V Dimensioni <i>Dimension:</i> 137x120x68 mm. Colore: nero <i>Color:</i> black Temperatura <i>Temperature:</i> 6000-6500K | | |
| * Articolo universale Universal part | | | |
| UNIVERSALE | | LED | |
|  | Faro lavoro con staffa <i>Working lamp with bracket</i> | | 3.47.070.80 |
| | 9 LED 3W 10-30V DC 650K IP67 | | |
| * Articolo universale Universal part | | | |
| UNIVERSALE | | | |
|  | Faro lavoro orientabile H3 <i>Adjustable headlamp H3</i> | | 3.47.050.00 |
| | 12-24V Dimensioni / <i>Dimension</i> 95x95 mm. | | |
| UNIVERSALE | | | |
|  | Faro lavoro orientabile H3 <i>Adjustable headlamp H3</i> | | 3.47.052.00 |
| | Con interruttore / <i>With switch</i> Dimensioni / <i>Dimension</i> 170x100 mm. | | |
| UNIVERSALE | | | |
|  | Faro lavoro orientabile H3 <i>Adjustable headlamp H3</i> | | 3.47.054.00 |
| | Con interruttore / <i>With switch</i> Dimensioni / <i>Dimension</i> 156x110 mm. | | |





| UNIVERSALE | | | LED |
|---|--|--|---------------------------|
|  | | <p>Lampada ispezione officina <i>Workshop inspection lamp</i></p> <p>Caratteristiche lampada / Lamp features: Pinza telescopica alluminio <i>Telescopic aluminium gripper 110-185 cm.</i> Due magneti <i>2 magnets</i> Temperatura luce: / <i>Light temperature: 5700-6000K</i> 42 led Osram Opto Semiconductors 1050LM</p> <p>Accessori inclusi / Included accessories Caricatore / <i>Charger 50Hz - AC230V</i> Presa per accendisigari / <i>Lighter-plug DC 12V</i> Cablaggio USB <i>Wiring USB</i> Batteria: / <i>Battery: 3.7V 1800mAh Li-Ion</i> Corrente di carica: / <i>Charge current: 12V 500mA</i> Dimensioni della lampada: / <i>Lamp dimensions: 900x28 mm.</i></p> | <p>3.47.074.80</p> |
| <p>* Articolo universale Universal part</p> | | | |





| UNIVERSALE | | | |
|---|--|--|---------------------------|
|  | | <p>Porta Estintore 6 Kg / <i>6kg Holder fire extinguisher</i></p> <p>Con cinghie nylon / <i>With nylon straps</i></p> <p>Dimensioni / <i>Dimension 635x282x227</i></p> | <p>5.47.100.00</p> |
| <p style="text-align: right;"></p> | | | |

| UNIVERSALE | BICI | LED |
|---|--|---------------------------|
|  | <p>Luce posteriore bici con cavo usb Resistente all'acqua - durata 20h - visibile a 200 m.</p> <p><i>Ultra bright smart bike rear light, rechargeable, Waterproof - 20 hours duration - visible 200 meters</i></p> <p>CON ACCELEROMETRO - ACCENSIONE AUTOMATICA DOPO FRENATA E REGOLAZIONE AUTOMATICA DELL'INTENSITÀ LUMINO. <i>Brake Sensing, Light Sensing, Auto start/stop, USB Charge, Saddle mount, Seatpost Mount.</i></p> | <p>2.03.010.80</p> |
| <p>* Ricambio di qualità equivalente Matching quality spare parts</p> | | |





UNIVERSALE

| | | |
|---|---|-------------------|
|  | Sterilizzatore anti Covid truck uvc <i>Sterilizer uvc lamp for truck</i> | 780.108.00 |
|  | Sterilizzatore anti Covid vettura uvc <i>Sterilizer uvc lamp for car</i> | 780.106.00 |
|  | Kit cavo completo per uvc <i>Cable kit for uvc</i> | 80.246.00 |
|  | Adattatore auto/casa lampada uvc <i>Car/home adaptor</i> | 60.700.00 |
|  | Timer meccanico giornaliero lampada uvc <i>Timer</i> | 60.710.00 |
|  | Sensore pirometrico rilevatore presenza <i>Pyrometric sensor</i> | 780.502 |

| | | | |
|---|--|---|---|
| <p>ECE 70.01 CLASSE 3 ECE 70.01 CLASS 3</p> | <p>PANNELLI PER MOTRICE MOTOR VEHICLE PANELS</p> |  | <p>Supporto in alluminio 565x130x1,0 mm. <i>Aluminum support 565x130x1,0 mm.</i></p> <p>4.46.40.01</p> |
| <p>Kit 2 pezzi pellicola 3M / 2 pcs kit 3M film</p> | | | |
| <p>ECE 70.01 CLASSE 3 ECE 70.01 CLASS 3</p> | <p>PANNELLI PER MOTRICE MOTOR VEHICLE PANELS</p> |  | <p>Adesivo 565x130 mm. <i>Adhesive 565x130 mm.</i></p> <p>4.46.40.02</p> |
| <p>Kit 2 pezzi pellicola 3M / 2 pcs kit 3M film</p> | | | |
| <p>ECE 70.01 CLASSE 3 ECE 70.01 CLASS 3</p> | <p>PANNELLI PER RIMORCHIO TRAILER PANELS</p> |  | <p>Supporto in alluminio 565x130x1,0 mm. <i>Aluminum support 565x130x1,0 mm.</i></p> <p>4.46.40.04</p> |
| <p>Kit 2 pezzi pellicola 3M / 2 pcs kit 3M film</p> | | | |
| <p>ECE 70.01 CLASSE 3 ECE 70.01 CLASS 3</p> | <p>PANNELLI PER RIMORCHIO TRAILER PANELS</p> |  | <p>Adesivo 565x130 mm. <i>Adhesive 565x130 mm.</i></p> <p>4.46.40.05</p> |
| <p>Kit 2 pezzi pellicola 3M / 2 pcs kit 3M film</p> | | | |
| <p>ECE 104 CLASSE 3 ECE 104 CLASS 3</p> | <p>NASTRO SEGNALAZIONE SAGOMA SHAPE SIGNALING TAPE</p> |  | <p>Giallo superfici rigide <i>Yellow ribbon rigid surface</i></p> <p>4.46.71.01</p> |
| <p>Dimensioni / Dimension 55 mm. x 50 m</p> | | | |

| | | | | |
|---|--|---|--|-------------------|
| ECE 104 CLASSE 3 ECE 104 CLASS 3 | NASTRO SEGNALAZIONE SAGOMA SHAPE SIGNALING TAPE |  | Rosso superfici rigide <i>Red ribbon rigid surface</i> | 4.46.71.03 |
| Dimensioni / Dimension 55 mm. x 50 m | | | | |
| ECE 104 CLASSE 3 ECE 104 CLASS 3 | NASTRO SEGNALAZIONE SAGOMA SHAPE SIGNALING TAPE |  | Bianco superfici rigide <i>White ribbon rigid surface</i> | 4.46.71.05 |
| Dimensioni / Dimension 55 mm. x 50 m | | | | |
| CLASSE 2 CLASS 2 | LIMITE VELOCITÀ 15 KM. SPEED LIMIT 15 KM. |  | Adesivo / Adhesive Ø 200 mm. | 4.46.50.15 |
| Kit 1 pezzo - confezione 8 pezzi / 1 pc Kit 8 pcs box | | | | |
| CLASSE 2 CLASS 2 | LIMITE VELOCITÀ 40 KM. SPEED LIMIT 40 KM. |  | Adesivo / Adhesive Ø 200 mm. | 4.46.50.40 |
| Kit 1 pezzo - confezione 8 pezzi / 1 pc Kit 8 pcs box | | | | |
| CLASSE 2 CLASS 2 | LIMITE VELOCITÀ 60 KM. SPEED LIMIT 60 KM. |  | Adesivo / Adhesive Ø 200 mm. | 4.46.50.60 |
| Kit 1 pezzo - confezione 8 pezzi / 1 pc Kit 8 pcs box | | | | |

| | | | | | |
|---|---|--|---|---|--------------------------|
| <p>CLASSE 2 CLASS 2</p> | <p>LIMITE VELOCITÀ 70 KM. SPEED LIMIT 70 KM.</p> | |  | <p>Adesivo / Adhesive Ø 200 mm.</p> | <p>4.46.50.70</p> |
| <p>Kit 1 pezzo - confezione 8 pezzi / 1 pc Kit 8 pcs box</p> | | | | | |
| <p>CLASSE 2 CLASS 2</p> | <p>LIMITE VELOCITÀ 80 KM. SPEED LIMIT 80 KM.</p> | |  | <p>Adesivo / Adhesive Ø 200 mm.</p> | <p>4.46.50.80</p> |
| <p>Kit 1 pezzo - confezione 8 pezzi / 1 pc Kit 8 pcs box</p> | | | | | |
| <p>CLASSE 2 CLASS 2</p> | <p>LIMITE VELOCITÀ 90 KM. SPEED LIMIT 90 KM.</p> | |  | <p>Adesivo / Adhesive Ø 200 mm.</p> | <p>4.46.50.90</p> |
| <p>Kit 1 pezzo - confezione 8 pezzi / 1 pc Kit 8 pcs box</p> | | | | | |
| <p>CLASSE 2 CLASS 2</p> | <p>LIMITE VELOCITÀ 100 KM. SPEED LIMIT 100 KM.</p> | |  | <p>Adesivo / Adhesive Ø 200 mm.</p> | <p>4.46.51.00</p> |
| <p>Kit 1 pezzo - confezione 8 pezzi / 1 pc Kit 8 pcs box</p> | | | | | |
| <p>DISPOSITIVO PIANO - CLASSE 2 BASE PLANE DEVICE - CLASS 2</p> | <p>TRASPORTO MERCI PERICOLOSE ADR DANGEROUS GOODS TRANSPORT ADR</p> | |  | <p>Lamiera zincata 400x300 mm. Galvanized sheet 400x 00 mm.</p> | <p>4.46.60.01</p> |
| <p>Confezione 2 pezzi / 2 pcs box</p> | | | | | |

| | | | |
|-----------------------------|---|--|--|
| CLASSE 1 CLASS 1 | TRASPORTO MERCI PERICOLOSE ADR DANGEROUS GOODS TRANSPORT ADR | |  <p>Lamiera zincata 300x320 mm. <i>Galvanized sheet 300x320 mm.</i></p> <p>4.46.60.02</p> <p>Confezione 2 pezzi / <i>2 pcs box</i></p> |
| CLASSE 2 CLASS 2 | PANNELLO PER CARICHI SPORGENTI PROTRUDING LOADS PANELS | |  <p>Alluminio / <i>Aluminum</i> 500 x 500 x 1,0 mm.</p> <p>4.46.70.01</p> <p>Confezione 2 pezzi / <i>2 pcs box</i></p> |
| | | ADESIVO PER TRUCK TRUCK STICKER |  <p>Adesivo angolo morto 170 x 250 mm. <i>Blind spot adhesive 170 x 250 mm.</i></p> <p>4.46.40.60</p> <p>Confezione 5 pezzi / <i>5 pcs box</i></p> |
| | | ADESIVO PER BUS BUS STICKER |  <p>Adesivo angolo morto 170 x 250 mm. <i>Blind spot adhesive 170 x 250 mm.</i></p> <p>4.46.40.70</p> <p>Confezione 5 pezzi / <i>5 pcs box</i></p> |

CAVO SPINE ABS-EBS
CABLE PLUGS ABS-EBS

N. 7 POLI 24V
7 PINS 24V



- ▶ Buone proprietà di riavvolgimento
Good rewinding properties
- ▶ Sistema di trasmissione dati separato per evitare interferenze elettriche
Separate transmission system to avoid electrical interferences
- ▶ Conforme ai regolamenti A.D.R. / *Compliant with ADR*
- ▶ Manicotti anti piegatura / *Anti-Kink Sleeves*
- ▶ Il cavo EBS funziona anche come ABS
EBS cable also functions as ABS

Materiale / Material:

- ▶ Poliuretano trattato per resistere al calore e alla luce
Polyurethane treated to resist color and light

Utilizzo / Use:

- ▶ Sistema di frenatura elettronico per motrici e rimorchi
Electronic braking system for vehicles and trailers
- ▶ Cavo 7P 3x1,5 mm.2 + 2x4,0 mm.2 + 2x1,0 mm.2 Ø spirale 55 mm.
Cable 7P 3x1,5 mm2 + 2x4,0 mm2 + 2x1,0 mm2 Ø spiral 55 mm.
- ▶ Massima estensione 3,50 m. / *Maximum extension 3.50 m.*

4.42.743.00

Normativa / Legislation: ISO 4091 - ISO 6722 - ISO 7638

ADATTATORE
CAVO SPIRALATO
COILED CABLE ADAPTER

N. 15 POLI 24V
2 SPINE FISSE 7 POLI
N. 15-POLE 24V - 2 FIXED 7-POLE PLUGS



- ▶ Esclusivo sistema di antidisinserimento della spina incorporato
Exclusive built-in anti-disconnection system for the plug
- ▶ Ultimo ritrovato della tecnologia "Thin Wall"
Latest discovery of „Thin Wall“ technology
- ▶ Connettori ISO / *ISO Connectors*
- ▶ Conforme ai regolamenti A.D.R. / *Compliant with ADR*

Materiale / Material:

- ▶ Poliuretano trattato per resistere al calore e alla luce
Polyurethane treated to resist color and light
- ▶ Guaina a consistenza morbida / *Sheath with a soft consistency*

Utilizzo / Use:

- ▶ Spina a 15 poli per motrici e rimorchi
15-pin plug for tractors and trailers
- ▶ Cavo 7P 6x1,0 mm.2 + 1x2,5 mm.2 Ø spirale 40 mm.
7P 6x1.0 mm2 cable + 1x2.5 mm2 Ø spiral 40 mm.
- ▶ Massima estensione 4,00 m. / *Maximum extension 4.00 m.*

4.42.956.00

Normativa / Legislation: ISO 12098

| | | |
|---|--|--------------------|
| CAVO SPIRALATO CON SPINE COILED CABLE WITH PLUGS | N. 7 POLI TIPO N N. 7 POLE TYPE N | |
|  | <ul style="list-style-type: none"> ▶ Massa di ritorno / <i>Return mass</i> ▶ Luce di posizione sinistra, luci di ingombro, illuminazione targa <i>Left position light, side markers, number plate lighting</i> ▶ Indicatore di direzione sinistra / <i>Left direction indicator</i> ▶ Luci stop / <i>Stop lights</i> ▶ Indicatore di direzione destra / <i>Right direction indicator</i> ▶ Luce di posizione destra, luce ingombro, illuminazione targa <i>Right position light, side markers, number plate lighting</i> ▶ Controllo di frenatura rimorchio / <i>Trailer braking control</i> ▶ Cavo 7P 6x1,0 mm.2 + 1x2,5 mm.2 Ø spirale 40 mm. <i>7P 6x1.0 mm2 cable + 1x2.5 mm2 Ø spiral 40 mm.</i> ▶ Massima estensione 3,50 m. / <i>Maximum extension 3.50 m.</i> <p>Normativa / Legislation: ISO 1185</p> | 4.42.056.07 |
| ADATTATORE COMPATTO DA SPINA COMPACT PLUG ADAPTER | N. 15 POLI - 24V A 2 PRESE 7 POLI N. 15 PINS - 24V WITH 2 7-PINS SO- CKETS | |
|  | <p>Normativa / Legislation:</p> <p>spina 15 poli ISO 12098 / <i>15 pins plug ISO 12098</i> spina 7 poli N ISO 1185 / <i>7 pins plug N ISO 1185</i> spina 7 poli N ISO 3731 / <i>7 pins plug N ISO 3731</i></p> | 4.42.130.00 |
| SPIRALE ARIA AIR SPIRAL | FLEXI AIR | |
|  | <ul style="list-style-type: none"> ▶ Spirale aria compatta e con elevata flessibilità <i>Compact and highly flexible air spiral</i> ▶ Pressione di scoppio minima 40 Bar <i>Minimum bursting pressure 40 bar</i> ▶ Diametro interno 50 mm. / <i>50 mm. internal diameter</i> ▶ Realizzato secondo le specifiche DIN 74323 e ISO 7375 <i>Manufactured according to DIN 74323 and ISO 7375 specifications</i> ▶ Soluzione compatta per utilizzo generico <i>Compact solution for general use</i> <p>Normativa: ISO 7375 testati fino a 10.000 stiramenti Legislation: ISO 7375 tested up to 10,000 stretches</p> | 4.55.324.11 |

| SPIRALE ARIA AIR SPIRAL | FLEXI AIR | |
|---|---|---------------------------|
|  | <ul style="list-style-type: none"> ▶ Spirale aria compatta e con elevata flessibilità <i>Compact and highly flexible air spiral</i> ▶ Pressione di scoppio minima 40 Bar <i>Minimum bursting pressure 40 bar</i> ▶ Diametro interno 50 mm. / <i>50 mm. internal diameter</i> ▶ Realizzato secondo le specifiche DIN 74323 e ISO 7375 <i>Manufactured according to DIN 74323 and ISO 7375 specifications</i> ▶ Soluzione compatta per utilizzo generico <i>Compact solution for general use</i> | <p>4.55.324.22</p> |
| <p>Normativa: ISO 7375 testati fino a 10.000 stiramenti Legislation: ISO 7375 tested up to 10,000 stretches</p> | | |

| TESTINA ACCOPIAMENTO AUTOMATIC NIPPLE | | |
|---|---|---------------------------|
|  | <p>Automatica / <i>Automatic</i> m. 16x1,5 mm. gialla / <i>yellow</i></p> | <p>4.14.000.03</p> |
| | <p>Automatica / <i>Automatic</i> m. 16x1,5 mm. rossa / <i>red</i></p> | <p>4.14.000.04</p> |

| TESTINA ACCOPIAMENTO AUTOMATIC NIPPLE | | |
|---|--|---------------------------|
|  | <p>Standard m. 16x1,5 mm. gialla / <i>yellow</i></p> | <p>4.14.000.07</p> |
| | <p>Standard m. 16x1,5 mm. rossa / <i>red</i></p> | <p>4.14.000.08</p> |

MIRRORS
RETROVISORI

BOBCAT | LIEBHERR
**TRATTORI E MEZZI MOVIMENTO TERRA
TRACTOR AND EARTHMOVING
VEHICLES**

Coppa nera
Black cover



68.5.752.025

Dimensioni / Dimension 371x197 mm.

DAF

Coppa nera manuale R2000 con morsetto
R2000 manual black cover with clamp



68.6.420.025

Dimensioni / Dimension 390x205 mm.

*** Ricambio di qualità equivalente | Matching quality spare parts**

FIAT | OM
242 | 40

72→87

Coppa nera manuale R2000 con morsetto OM 40/35
R2000 manual black cover with clamp



68.5.800.025

Dimensioni / Dimension 230x180 mm. | Ø 18

*** Ricambio di qualità equivalente | Matching quality spare parts**

FIAT | OM
242 | 40

72→87

Coppa nera manuale R2000 con morsetto OM 40/35
R2000 manual black cover with clamp



68.5.801.025

Dimensioni / Dimension 230x180 mm. | Ø 20

*** Ricambio di qualità equivalente | Matching quality spare parts**





FIAT

DUCATO



06→

| | | |
|---|---|-------------------|
| Retrovisore manuale con braccio corto <i>Manual with short arm</i> | ← | 67.2301 |
| Retrovisore manuale con braccio corto <i>Manual with short arm</i> | → | 67.2302 |
| Retrovisore manuale con sonda braccio corto <i>Manual with short arm and sonde</i> | ← | 67.2307 |
| Retrovisore elettrico riscaldato braccio corto <i>Electrical heated short arm</i> | ← | 67.2309 |
| Retrovisore elettrico riscaldato braccio corto con sonda <i>Electrical heated short arm and sonde</i> | ← | 67.2323 |
| Retrovisore elettrico riscaldato braccio corto con sonda abbattimento elettrico <i>Electrical heated and foldable short arm and sonde</i> | ← | 67.2329 |
| Retrovisore elettrico riscaldato braccio corto con sonda abbattimento elettrico <i>Electrical heated and foldable short arm and sonde</i> | → | 67.2328 |
| Retrovisore manuale con braccio lungo <i>Manual long arm</i> | → | 67.2358 |
| Retrovisore manuale con braccio lungo <i>Manual long arm</i> | ← | 67.2357 |
| Retrovisore elettrico riscaldato braccio lungo <i>Electrical heated long arm</i> | ← | 67.2367 |
| Retrovisore elettrico riscaldato braccio lungo <i>Electrical heated long arm</i> | → | 67.2368 |
| Vetro principale con piastra <i>Main glass with plate</i> | → | 67.0658 |
| Vetro principale con piastra <i>Main glass with plate</i> | ← | 67.0657 |
| Vetro termico principale con piastra <i>Main thermic glass with plate</i> | → | 70.1018.40 |
| Vetro termico principale con piastra <i>Main thermic glass with plate</i> | ← | 70.1019.40 |
| Vetro termico grandangolare con piastra <i>Wide angle thermic glass with plate</i> | → | 70.1018.60 |
| Vetro termico grandangolare con piastra <i>Wide angle thermic glass with plate</i> | → | 70.1019.60 |







| FIAT | | FIORINO BIPPER NEMO | | |
|---|-------|--|---|---------------------|
|  | 08→ | Retrovisore elettrico riscaldato <i>Electrical heated mirror</i> | → | 67.1032.01 |
| | | Retrovisore elettrico riscaldato <i>Electrical heated mirror</i> | ← | 67.1033.01 |
| IVECO | | AUTOBUS URBANI | | |
|  | | Coppa nera termica 12V <i>12V thermic black cover</i> | ↔ | 68.7.601.025 |
| | | Dimensioni / <i>Dimension</i> 370x210 mm. | | |
| IVECO | | DAILY 2000 | | |
|  | 99→06 | Vetrino grandangolare <i>Wide angle glass</i> | ↔ | 68.5.401.045 |
| | | | | |
| IVECO | | DAILY 2000 | | |
|  | 00→05 | Retrovisore manuale riscaldato braccio medio <i>Manual heated mirror medium arm</i> | → | 67.1070 |
| | | Retrovisore manuale riscaldato braccio medio <i>Manual heated mirror medium arm</i> | ← | 67.1069 |

| IVECO | | DAILY | |
|---|------------------|---|------------------|
|  | 00→05 | Retrovisore manuale con sonda braccio corto <i>Manual with short arm and sonde</i> | ← 67.1207 |
| | | Retrovisore manuale con braccio corto <i>Manual with short arm</i> | ← 67.1067 |
| | | Retrovisore manuale con braccio corto <i>Manual short arm</i> | → 67.1068 |
| | | Retrovisore elettrico riscaldato braccio corto <i>Electrical heated short arm</i> | ← 67.1073 |
| | | Retrovisore elettrico riscaldato braccio corto <i>Electrical heated short arm</i> | → 67.1074 |
| | | Retrovisore elettrico riscaldato braccio medio <i>Electrical heated medium arm</i> | ← 67.1075 |
| | | Retrovisore elettrico riscaldato braccio medio <i>Electrical heated medium arm</i> | → 67.1076 |
| | | Retrovisore elettrico riscaldato braccio lungo con sonda <i>Electrical heated long arm and sonde</i> | ← 67.1227 |
| | | Retrovisore elettrico riscaldato braccio lungo <i>Electrical heated long arm</i> | ← 67.1077 |
| Retrovisore elettrico riscaldato braccio lungo <i>Electrical heated long arm</i> | → 67.1078 | | |

| IVECO | | DAILY III | |
|---|-------|---|------------------------|
|  | 06→11 | Vetro principale con piastra termica 12V <i>Main glass with thermic plate 12V</i> | → 68.7.417.V44Q |
| | | Vetro principale con piastra termica 12V <i>Main glass with thermic plate 12V</i> | ← 68.7.417.V45Q |
| | | Vetro grandangolare con piastra termica 12V <i>Wide angle thermic glass with thermic plate 12V</i> | → 68.7.418.V44Q |
| | | Vetro grandangolare con piastra termica 12V <i>Wide angle thermic glass with thermic plate 12V</i> | ← 68.7.418.V45Q |

| IVECO | | EUROCARGO EUROSTAR STRALIS 1°S | |
|---|-------|---|----------------------------|
|  | 93→05 | Calotta - modello Vitaloni <i>Cover - Vitaloni model</i> | → ← 68.9.527.012 |
| | | | |

| IVECO | | EUROCARGO EUROSTAR STRALIS 1°S | |
|---|-------|--|--------------------------|
|  | 93→05 | Calotta - modello Donnelly Cover - Donnelly model | ↔ 68.9.526.012 |
| | | | |
| IVECO | | EUROCARGO STRALIS TRAKKER TECTOR | |
|  | →06 | Specchio completo grandangolare manuale Full manual wide angle mirror | 68.5.622.000 |
| | | Attacco R450 / R450 connector | |
| IVECO | | EUROCARGO STRALIS 1ª SERIE EUROSTAR | |
|  | 00→06 | Specchio completo grandangolare grigio Grey wide angle full mirror | 68.5.631.001 |
| | | R300 | |
| IVECO | | EUROCARGO STRALIS EUROSTAR | |
|  | 93→06 | Specchio grigio scuro Vitaloni elettrico, termico 24V - mm. 457x215/R1300 Dark grey mirror Vitaloni electric, thermal 24V mm. 457X215 / R1300 | 68.9.523.V25 |
| | | Vetro con piastra termica 24V 442x197 mm. attacco a ghiera Glass with thermic plate 24V 442x197 mm. ring nut connection | 68.7.523.V45 |
| | | Calotta grigio scuro / Dark grey cover | 68.9.528.012 |
| | | | |
| IVECO | | EUROCARGO STRALIS EUROSTAR | |
|  | 93→06 | Calotta grigio scuro Donnelly 429x153 mm. Dark grey cover Donnelly 429x153 mm. | 68.9.523.012 |
| | | Calotta grigio chiaro Donnelly 429x153 mm. Light grey cover Donnelly 429x153 mm. | 68.9.525.012 |
| | | * Ricambi per originale / Spare parts for original | |

| IVECO | EUROCARGO STRALIS TRAKKER TECTOR | | |
|---|---|---|--|
|  | 06→ | Vetro principale con piastra termica 24V <i>Main glass with thermic plate 24V</i> | 68.7.524.V45 |
| | | Dimensioni / Dimension 376x187 mm. | |
| IVECO | EUROCARGO STRALIS TRAKKER TECTOR | | |
|  | 06→ | Vetro grandangolare con piastra riscaldata 24V <i>Wide angle glass with 24V heated plate</i> | 68.7.525.V45 |
| | | Dimensioni / Dimension 210x196 mm. | |
| IVECO | EUROSTAR EUROTECH TRAKKER STRALIS EUROTRAKKER | | |
|  | 93→06 | Specchio grigio scuro termico 24V 355x215 mm./R1300 <i>Dark gray thermic mirror 24V - 355x215 mm./R1300</i> |   68.9.522.V25 |
| | | Vetro con piastra termica 24V 340x197 mm. attacco a ghiera <i>Glass with thermic plate 24V 340x197 mm. ring nut connection</i> | |
| | | Vetro con piastra termica 24V 340x197 mm. attacco a molla Vitaloni <i>Glass with thermic plate 24V 340x197 mm. Vitaloni spring connection</i> | 68.7.521.V45 |
| | | Calotta grigio scuro Dimensione 328x153 mm. <i>Dark grey cover Dimension 328x153 mm.</i> | 68.9.522.012 |
| | | | |
| IVECO | EUROTECH EUROSTAR EUROTRAKKER | | |
|  | 93→ | Retrovisore grandangolo elettrico riscaldato Vitaloni/Donnelly <i>Electrical heated wide mirror</i> | 68.6.622.000 |
| | | Vetro con piastra e con ghiera (modello Donnelly) <i>Glass with plate (Donnelly model)</i> | 68.7.517.020 |

| IVECO | | STRALIS EUROCARGO | | |
|---|-----|---------------------|---|-------------------|
|  | 06→ | Calotta Cover | → | 70.1000.20 |
| | | Calotta Cover | ← | 70.1001.20 |
| | | | | |

| IVECO | | STRALIS EUROCARGO | | |
|---|-----|---|---|-------------------|
|  | 06→ | Calotta grandangolo Wide angle cover | → | 70.1000.30 |
| | | Calotta grandangolo Wide angle cover | ← | 70.1001.30 |
| | | | | |

| IVECO | | STRALIS | | |
|--|-----|---|--|-------------------|
|  | 07→ | Guardaruota manuale riscaldato Manual heated roof mirror | | 67.0103 |
| | | Copertura braccio Arm cover | | 70.1032.90 |
| | | | | |

| IVECO | | STRALIS | | |
|---|-----|--|---|----------------|
|  | 07→ | Guarda avanti manuale riscaldato Manual heated angle mirror | ← | 67.0107 |
| | | | | |

| IVECO | | 190 TURBO AUTOBUS STARBUS MAGIRUS DEUTZ | | |
|---|--|---|--------|---------------------|
|  | | Coppa nera manuale Manual black cover | ← → | 68.5.796.025 |
| | | Coppa nera termica 24V Thermic black cover 24V | ← → | 68.7.796.025 |
| | | Resistenza 24V / 24V resistance | | 68.7.750.035 |
| | | Dimensioni / Dimension 440x210 mm. | | |

| IVECO | | OM 170/35 159/20 110/190 FIAT 170NT35 130NC 150NR AUTOBUS 309 409 370 | |
|--|--|---|---------------------|
|   resistenza | Coppa grigia manuale <i>Manual grey cover</i> | ← → | 68.5.793.025 |
| | Coppa nera manuale <i>Manual black cover</i> | ← → | 68.5.791.025 |
| | Coppa nera termica 24V <i>Thermic black cover 24V</i> | ← → | 68.7.792.025 |
| | Coppa grigia termica 24V <i>Thermic grey cover 24V</i> | ← → | 68.7.793.025 |
| | Resistenza 24V universale (310x155 mm.) <i>Universal 24V resistance (310x155 mm.)</i> | | 68.7.750.035 |
| | Dimensioni / <i>Dimension 359x209 mm.</i> | | |

| IVECO | | OM50 50NC 60NC 60.10 79.13 | |
|--|---|------------------------------------|---------------------|
|  | Coppa nera manuale <i>Manual black cover</i> | ← → | 68.5.675.025 |
| | Dimensioni / <i>Dimension 346x162 mm.</i> | | |

| MANITOU CLASS GOLDONI JOHN DEERE | | TRATTORI E MEZZI MOVIMENTO TERRA TRACTOR AND EARTHMOVING VEHICLES | |
|---|---|---|---------------------|
|  | Coppa ricambio nera <i>Black cover</i> | ← → | 68.6.152.025 |
| | Dimensioni / <i>Dimension 245x155 mm.</i> | | |

| MANITOU CLASS GOLDONI JOHN DEERE | | TRATTORI E MEZZI MOVIMENTO TERRA | |
|---|---|----------------------------------|---------------------|
|  | Coppa nera <i>Black cover</i> | ← → | 68.5.753.025 |
| | Dimensioni / <i>Dimension 260x160 mm.</i> | | |

| | | | | | |
|---|--|---|--|--|---------------------|
| MERCEDES | | LK08 | | | |
|  | | Coppa nera manuale 24V/R2000 24V/R2000 manual black cover Cavo bipolare / Bipolar cable |   | 68.5.200.025 | |
| | | Dimensioni / Dimension 304x184 mm. | | | |
| UNIVERSALE | | TRATTORI E MEZZI MOVIMENTO TERRA | | | |
|  | | Coppa nera attacco D. 16-18-20 Black cover (connection D 16-18-20) |   | 68.6.418.025 | |
| | | Dimensioni / Dimension 246x182 mm. | | | |
| UNIVERSALE | | | | | |
|  | | Coppa nera Black cover |  |   | 68.6.398.025 |
| | | Dimensioni / Dimension 225x312 mm. Ø 18 cm. | | | |
| UNIVERSALE | | OM | | | |
|  | | Coppa nera Black cover |  |   | 68.4.466.025 |
| | | Dimensioni / Dimension 142x237 mm. Ø 20 cm. | | | |
| UNIVERSALE | | TRATTORI | | | |
|  | | Braccio con supporto Arm with holder |  | 68.6.153.031 | |
| | | Dimensioni / Dimension 310 mm. Ø 20 cm. | | | |

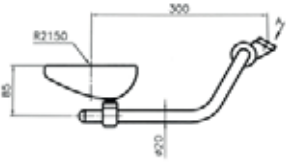
| UNIVERSALE | TRATTORI | | |
|---|--|---|---------------------|
|  | Braccio con supporto <i>Arm with holder</i> | ➔ | 68.6.154.030 |
| | Braccio con supporto <i>Arm with holder</i> | ➜ | 68.6.154.031 |
| | Dimensioni / <i>Dimension</i> 300 mm. Ø 20 cm. | | |

| UNIVERSALE | TRATTORI BRIEDA | | |
|---|-----------------------|---|---------------------|
|  | Braccio <i>Arm</i> | ➔ | 68.6.155.030 |
| | Braccio <i>Arm</i> | ➜ | 68.6.155.031 |
| | | | |

| UNIVERSALE | TRATTORI | | |
|---|--|---|---------------------|
|  | Braccio con supporto <i>Arm with holder</i> | ➔ | 68.6.399.030 |
| | Braccio con supporto <i>Arm with holder</i> | ➜ | 68.6.399.031 |
| | | | |

CODE INDEX
INDICE PER CODICE

INDICE PER CODICE CODE INDEX

| CODICE/CODE | PAG. | CODICE/CODE | PAG. | CODICE/CODE | PAG. | CODICE/CODE | PAG. |
|-------------|--------------|-------------|---------|-------------|---------|-------------|------|
| 1.01.050.00 | 6 | 1.02.134.12 | 18 | 1.04.060.10 | 49 | 1.04.137.00 | 40 |
| 1.01.050.24 | 6 | 1.02.136.00 | 24 | 1.04.060.18 | 49 | 1.04.138.00 | 41 |
| 1.01.050.25 | 6 | 1.02.137.00 | 24 | 1.04.061.10 | 49 | 1.04.139.00 | 41 |
| 1.01.052.00 | 8 | 1.02.144.12 | 24 | 1.04.061.18 | 49 | 1.04.140.00 | 41 |
| 1.01.053.00 | 8 | 1.02.146.12 | 18 - 24 | 1.04.062.00 | 53 | 1.04.141.00 | 41 |
| 1.01.054.00 | 7 | 1.02.148.00 | 16 - 29 | 1.04.062.10 | 53 | 1.04.142.00 | 51 |
| 1.01.054.18 | 7 | 1.02.150.00 | 35 | 1.04.063.00 | 53 | 1.04.142.16 | 51 |
| 1.01.055.00 | 7 | 1.02.151.00 | 35 | 1.04.063.10 | 53 | 1.04.143.00 | 51 |
| 1.01.056.00 | 7 | 1.02.154.00 | 32 | 1.04.064.00 | 54 | 1.04.143.16 | 51 |
| 1.01.057.00 | 7 | 1.02.155.00 | 32 | 1.04.065.00 | 54 | 1.04.144.00 | 37 |
| 1.02.052.00 | 14 | 1.02.156.00 | 35 | 1.04.078.10 | 64 | 1.04.146.00 | 38 |
| 1.02.054.12 | 14 - 23 | 1.02.157.00 | 35 | 1.04.078.18 | 64 | 1.04.147.00 | 38 |
| 1.02.055.12 | 14 - 23 | 1.02.158.00 | 34 | 1.04.079.10 | 64 | 1.04.148.00 | 75 |
| 1.02.056.00 | 14 | 1.02.159.00 | 34 | 1.04.079.18 | 64 | 1.04.149.00 | 75 |
| 1.02.057.00 | 14 | 1.02.160.00 | 15 | 1.04.080.10 | 62 | 1.04.150.00 | 52 |
| 1.02.058.12 | 15 - 17 | 1.02.161.00 | 15 | 1.04.080.18 | 62 | 1.04.151.00 | 52 |
| 1.02.060.00 | 15 | 1.02.164.00 | 28 | 1.04.081.10 | 62 | 1.04.152.00 | 51 |
| 1.02.064.00 | 28 | 1.02.165.00 | 28 | 1.04.081.18 | 62 | 1.04.152.90 | 51 |
| 1.02.066.00 | 21 - 23 | 1.02.166.00 | 28 | 1.04.082.00 | 46 | 1.04.153.00 | 51 |
| 1.02.066.11 | 21 - 23 | 1.02.167.00 | 28 | 1.04.090.00 | 57 | 1.04.153.90 | 51 |
| 1.02.068.00 | 17 | 1.02.168.00 | 23 | 1.04.092.00 | 63 | 1.04.154.00 | 76 |
| 1.02.070.00 | 17 | 1.02.169.00 | 23 | 1.04.106.00 | 63 | 1.04.155.00 | 76 |
| 1.02.074.00 | 18 | 1.02.172.12 | 31 | 1.04.107.00 | 63 | 1.04.156.00 | 76 |
| 1.02.076.00 | 18 | 1.02.174.00 | 27 | 1.04.108.00 | 63 | 1.04.157.00 | 76 |
| 1.02.078.00 | 21 | 1.02.174.80 | 27 | 1.04.109.00 | 63 | 1.04.158.00 | 76 |
| 1.02.080.12 | 19 - 20 - 23 | 1.02.175.00 | 27 | 1.04.110.00 | 63 | 1.04.159.00 | 76 |
| 1.02.082.00 | 19 | 1.02.175.80 | 27 | 1.04.112.00 | 55 | 1.04.160.00 | 76 |
| 1.02.088.00 | 19 | 1.02.176.00 | 27 | 1.04.113.00 | 55 | 1.04.161.00 | 76 |
| 1.02.090.00 | 20 - 24 | 1.02.176.80 | 27 | 1.04.116.00 | 63 | 1.04.162.00 | 76 |
| 1.02.092.00 | 20 | 1.02.177.00 | 27 | 1.04.118.00 | 70 | 1.04.163.00 | 76 |
| 1.02.094.00 | 21 | 1.02.177.80 | 27 | 1.04.118.17 | 71 | 1.04.166.00 | 70 |
| 1.02.096.12 | 20 | 1.02.180.00 | 27 | 1.04.119.00 | 70 | 1.04.167.00 | 70 |
| 1.02.098.00 | 18 | 1.02.181.00 | 27 | 1.04.119.17 | 71 | 1.04.170.00 | 70 |
| 1.02.100.12 | 34 | 1.02.182.00 | 16 | 1.04.120.00 | 71 | 1.04.171.00 | 70 |
| 1.02.102.12 | 28 - 29 | 1.02.183.00 | 16 | 1.04.121.00 | 71 | 1.04.172.06 | 70 |
| 1.02.110.12 | 24 | 1.02.184.00 | 30 | 1.04.122.00 | 71 - 72 | 1.04.173.06 | 70 |
| 1.02.116.12 | 31 | 1.02.185.00 | 30 | 1.04.124.00 | 71 | 1.04.174.00 | 72 |
| 1.02.120.12 | 34 | 1.02.186.00 | 16 | 1.04.125.00 | 71 | 1.04.175.00 | 72 |
| 1.02.122.00 | 35 | 1.02.187.00 | 16 | 1.04.126.00 | 69 | 1.04.176.00 | 72 |
| 1.02.123.00 | 35 | 1.02.188.00 | 16 | 1.04.127.00 | 69 | 1.04.177.00 | 72 |
| 1.02.124.00 | 14 | 1.02.189.00 | 16 | 1.04.128.00 | 70 | 1.04.178.00 | 72 |
| 1.02.125.00 | 14 | 1.02.190.00 | 17 | 1.04.129.00 | 70 | 1.04.180.00 | 72 |
| 1.02.126.00 | 15 | 1.02.191.00 | 17 | 1.04.134.00 | 40 | 1.04.180.17 | 73 |
| 1.02.127.00 | 15 | 1.02.192.00 | 17 | 1.04.135.00 | 40 | 1.04.181.00 | 72 |
| 1.02.132.12 | 31 | 1.02.193.00 | 17 | 1.04.136.00 | 40 | 1.04.181.17 | 73 |

| CODICE/CODE | PAG. | CODICE/CODE | PAG. | CODICE/CODE | PAG. | CODICE/CODE | PAG. |
|-------------|---------|-------------|------|-------------|------|-------------|---------|
| 1.04.182.06 | 73 | 1.04.233.16 | 69 | 1.04.283.00 | 62 | 1.04.330.80 | 42 |
| 1.04.183.06 | 73 | 1.04.234.06 | 66 | 1.04.284.00 | 66 | 1.04.331.16 | 42 |
| 1.04.184.00 | 74 | 1.04.235.06 | 66 | 1.04.285.06 | 66 | 1.04.331.80 | 42 |
| 1.04.185.00 | 74 | 1.04.238.00 | 41 | 1.04.286.00 | 67 | 1.04.332.16 | 42 |
| 1.04.186.00 | 52 | 1.04.239.00 | 41 | 1.04.287.06 | 67 | 1.04.332.80 | 42 |
| 1.04.187.00 | 52 | 1.04.240.00 | 42 | 1.04.288.16 | 71 | 1.04.333.16 | 42 |
| 1.04.188.00 | 52 | 1.04.241.00 | 42 | 1.04.289.16 | 71 | 1.04.333.80 | 42 |
| 1.04.189.00 | 52 | 1.04.242.00 | 41 | 1.04.290.00 | 74 | 1.04.334.00 | 40 |
| 1.04.190.06 | 52 | 1.04.243.00 | 41 | 1.04.291.00 | 74 | 1.04.335.00 | 40 |
| 1.04.191.06 | 52 | 1.04.244.00 | 41 | 1.04.292.00 | 74 | 1.04.336.00 | 40 |
| 1.04.194.00 | 62 | 1.04.245.00 | 41 | 1.04.293.00 | 74 | 1.04.337.00 | 40 |
| 1.04.195.00 | 62 | 1.04.246.00 | 39 | 1.04.294.00 | 74 | 1.04.338.00 | 77 |
| 1.04.198.00 | 50 - 52 | 1.04.247.00 | 39 | 1.04.296.00 | 53 | 1.04.338.80 | 77 |
| 1.04.199.00 | 50 - 52 | 1.04.248.00 | 39 | 1.04.296.06 | 53 | 1.04.339.00 | 77 |
| 1.04.200.06 | 50 | 1.04.249.00 | 39 | 1.04.296.16 | 53 | 1.04.339.80 | 77 |
| 1.04.201.06 | 50 | 1.04.250.00 | 39 | 1.04.297.00 | 53 | 1.04.340.80 | 78 |
| 1.04.202.00 | 38 | 1.04.251.00 | 39 | 1.04.297.06 | 53 | 1.04.342.00 | 78 |
| 1.04.203.00 | 38 | 1.04.252.00 | 39 | 1.04.297.16 | 53 | 1.04.344.80 | 77 |
| 1.04.204.00 | 37 | 1.04.253.00 | 39 | 1.04.298.16 | 51 | 1.04.345.80 | 77 |
| 1.04.205.00 | 37 | 1.04.254.00 | 38 | 1.04.298.80 | 75 | 1.04.346.00 | 78 |
| 1.04.206.00 | 38 | 1.04.255.00 | 38 | 1.04.299.16 | 51 | 1.04.346.16 | 78 |
| 1.04.206.17 | 38 | 1.04.256.00 | 38 | 1.04.299.80 | 75 | 1.04.347.00 | 78 |
| 1.04.207.00 | 38 | 1.04.257.00 | 38 | 1.04.300.80 | 43 | 1.04.347.16 | 78 |
| 1.04.207.17 | 38 | 1.04.258.00 | 68 | 1.04.301.80 | 43 | 1.04.348.17 | 77 - 78 |
| 1.04.208.00 | 58 | 1.04.259.00 | 68 | 1.04.302.80 | 43 | 1.04.350.00 | 79 |
| 1.04.209.00 | 58 | 1.04.260.00 | 68 | 1.04.303.80 | 43 | 1.04.350.06 | 79 |
| 1.04.210.00 | 58 | 1.04.261.00 | 68 | 1.04.304.80 | 43 | 1.04.351.00 | 79 |
| 1.04.211.00 | 58 | 1.04.262.00 | 68 | 1.04.305.80 | 43 | 1.04.351.06 | 79 |
| 1.04.212.00 | 57 | 1.04.263.00 | 68 | 1.04.306.80 | 43 | 1.04.352.80 | 79 |
| 1.04.213.00 | 57 | 1.04.264.00 | 67 | 1.04.307.80 | 43 | 1.04.353.80 | 79 |
| 1.04.214.00 | 49 | 1.04.265.00 | 67 | 1.04.310.00 | 65 | 1.04.354.80 | 79 |
| 1.04.216.00 | 48 | 1.04.266.00 | 67 | 1.04.311.00 | 65 | 1.04.355.80 | 79 |
| 1.04.218.00 | 54 | 1.04.267.00 | 67 | 1.04.312.00 | 65 | 1.04.356.00 | 79 |
| 1.04.220.00 | 66 | 1.04.268.00 | 67 | 1.04.313.00 | 65 | 1.04.356.06 | 80 |
| 1.04.221.00 | 66 | 1.04.269.00 | 67 | 1.04.314.00 | 45 | 1.04.357.00 | 79 |
| 1.04.222.00 | 66 | 1.04.270.00 | 68 | 1.04.315.00 | 45 | 1.04.357.06 | 80 |
| 1.04.223.00 | 66 | 1.04.270.06 | 69 | 1.04.316.00 | 45 | 1.04.358.06 | 81 |
| 1.04.224.00 | 64 | 1.04.271.00 | 68 | 1.04.318.80 | 45 | 1.04.358.80 | 81 |
| 1.04.225.00 | 64 | 1.04.271.06 | 69 | 1.04.320.80 | 45 | 1.04.359.06 | 81 |
| 1.04.226.00 | 65 | 1.04.272.00 | 68 | 1.04.322.00 | 39 | 1.04.359.80 | 81 |
| 1.04.227.00 | 65 | 1.04.272.06 | 69 | 1.04.323.00 | 39 | 1.04.360.80 | 80 |
| 1.04.228.00 | 65 | 1.04.273.00 | 68 | 1.04.324.00 | 40 | 1.04.361.80 | 80 |
| 1.04.229.00 | 65 | 1.04.273.06 | 69 | 1.04.325.00 | 40 | 1.04.362.06 | 80 |
| 1.04.230.00 | 65 | 1.04.278.00 | 58 | 1.04.326.80 | 58 | 1.04.362.80 | 80 |
| 1.04.231.00 | 65 | 1.04.279.00 | 58 | 1.04.327.80 | 58 | 1.04.363.06 | 80 |
| 1.04.232.00 | 69 | 1.04.280.00 | 58 | 1.04.328.80 | 59 | 1.04.363.80 | 80 |
| 1.04.232.16 | 69 | 1.04.281.00 | 58 | 1.04.329.80 | 59 | 1.04.364.80 | 80 |
| 1.04.233.00 | 69 | 1.04.282.00 | 62 | 1.04.330.16 | 42 | 1.04.365.80 | 80 |

| CODICE/CODE | PAG. | CODICE/CODE | PAG. | CODICE/CODE | PAG. | CODICE/CODE | PAG. |
|-------------|--------------|-------------|-----------|---------------|-----------|---------------|-----------|
| 1.05.052.00 | 82 | 1.06.078.00 | 89 | 1.43.052.00 | 130 | 1.44.059.00UK | 176 |
| 1.05.054.00 | 82 - 85 | 1.06.079.00 | 89 | 1.43.053.00 | 130 | 1.44.059.20 | 175 |
| 1.05.056.00 | 83 - 84 - 85 | 1.06.080.00 | 89 | 1.43.054.00 | 130 | 1.44.060.00 | 180 |
| 1.05.058.00 | 87 | 1.06.081.00 | 89 | 1.43.056.00 | 130 | 1.44.061.00 | 180 |
| 1.05.060.00 | 87 | 1.06.086.00 | 89 - 92 | 1.43.058.00 | 129 | 1.44.063.01 | 180 |
| 1.05.062.00 | 84 | 1.06.087.00 | 89 - 92 | 1.43.060.00 | 129 | 1.44.064.00 | 178 |
| 1.05.064.00 | 84 | 1.06.088.00 | 90 | 1.43.064.00 | 131 | 1.44.064.21 | 178 - 179 |
| 1.05.070.00 | 86 | 1.06.089.00 | 90 | 1.43.068.00 | 131 | 1.44.065.00 | 178 |
| 1.05.072.80 | 82 | 1.06.090.00 | 91 | 1.43.069.00 | 131 | 1.44.066.01 | 178 |
| 1.05.074.00 | 85 | 1.06.091.00 | 91 | 1.43.070.00 | 132 | 1.44.067.01 | 178 |
| 1.05.080.80 | 82 | 1.06.092.00 | 90 | 1.43.071.00 | 132 | 1.44.070.22 | 178 |
| 1.05.084.00 | 86 | 1.06.093.00 | 90 | 1.43.076.00 | 130 | 1.44.094.00 | 195 |
| 1.05.086.00 | 87 | 1.06.094.00 | 90 | 1.43.077.00 | 130 | 1.44.096.00 | 170 |
| 1.05.090.12 | 87 | 1.06.095.00 | 90 | 1.43.078.00 | 131 | 1.44.098.00 | 174 |
| 1.05.092.00 | 83 | 1.08.052.00 | 93 | 1.43.079.00 | 131 | 1.44.100.00 | 179 |
| 1.05.096.00 | 86 | 1.08.056.00 | 93 | 1.43.080.80 | 131 | 1.44.101.00 | 179 |
| 1.05.098.00 | 88 | 1.09.050.00 | 36 - 135 | 1.43.081.80 | 131 | 1.44.102.70 | 179 |
| 1.05.100.00 | 88 | 1.09.051.00 | 36 | 1.43.082.80 | 152 | 1.44.103.01 | 179 |
| 1.05.104.00 | 82 | 1.09.051.50 | 247 | 1.43.082.82 | 152 | 1.44.104.00 | 170 |
| 1.05.106.00 | 84 | 1.09.052.00 | 102 - 125 | 1.43.082.83 | 152 | 1.44.105.00 | 170 |
| 1.05.110.00 | 88 | 1.41.052.00 | 106 | 1.43.083.80 | 152 | 1.44.106.00 | 170 |
| 1.05.112.00 | 83 | 1.41.052.24 | 106 | 1.43.084.80 | 152 | 1.44.107.00 | 170 |
| 1.05.114.00 | 86 | 1.41.053.00 | 106 | 1.43.091.80 | 152 | 1.45.050.00 | 232 |
| 1.05.116.12 | 87 | 1.41.053.24 | 106 | 1.43.092.80 | 152 | 1.45.054.00 | 231 |
| 1.05.116.19 | 87 | 1.42.050.00 | 115 | 1.43.092.82 | 152 | 1.45.060.00 | 232 |
| 1.05.118.00 | 85 | 1.42.052.00 | 115 | 1.43.092.83 | 152 | 1.45.062.00 | 231 |
| 1.05.120.00 | 84 | 1.42.054.00 | 115 | 1.43.093.80 | 152 | 1.45.064.00 | 231 |
| 1.05.122.00 | 88 | 1.42.058.11 | 115 | 1.43.094.80 | 152 | 1.45.066.00 | 232 |
| 1.05.124.00 | 88 | 1.42.060.00 | 116 | 1.44.050.00 | 169 - 175 | 1.45.068.00 | 231 |
| 1.05.126.00 | 88 | 1.42.062.00 | 117 | 1.44.050.20 | 169 - 175 | 1.46.050.00 | 236 |
| 1.05.128.80 | 83 | 1.42.063.00 | 117 | 1.44.050.20 | 177 | 1.46.052.00 | 236 |
| 1.06.052.00 | 89 | 1.42.064.00 | 117 | 1.44.050.20 | 177 | 1.48.058.00 | 240 |
| 1.06.053.00 | 89 | 1.42.065.00 | 117 | 1.44.050.28 | 177 | 1.48.060.00 | 240 |
| 1.06.058.00 | 90 | 1.42.066.00 | 117 | 1.44.051.00 | 169 - 175 | 1.48.060.80 | 240 |
| 1.06.059.00 | 90 | 1.42.067.00 | 117 | 1.44.051.20 | 169 - 175 | 2.01.050.00 | 8 |
| 1.06.064.00 | 91 | 1.42.068.00 | 117 | 1.44.051.20 | 177 | 2.01.051.00 | 8 |
| 1.06.065.00 | 91 | 1.42.069.00 | 117 | 1.44.051.29 | 177 | 2.01.052.00 | 8 |
| 1.06.066.00 | 91 | 1.42.070.10 | 118 | 1.44.052.00 | 183 | 2.01.053.00 | 8 |
| 1.06.067.00 | 91 | 1.42.072.00 | 118 | 1.44.052.20 | 180 - 183 | 2.01.054.00 | 9 |
| 1.06.068.00 | 91 | 1.42.074.24 | 119 | 1.44.053.00 | 183 | 2.01.055.00 | 9 |
| 1.06.069.00 | 91 | 1.42.075.24 | 119 | 1.44.053.20 | 180 - 183 | 2.01.056.00 | 12 |
| 1.06.070.00 | 91 | 1.42.076.00 | 119 | 1.44.055.01 | 183 | 2.01.057.00 | 12 |
| 1.06.070.01 | 92 | 1.42.076.11 | 120 | 1.44.056.00 | 169 - 177 | 2.01.058.00 | 9 |
| 1.06.071.00 | 91 | 1.42.077.00 | 119 | 1.44.057.00 | 169 - 177 | 2.01.059.00 | 9 |
| 1.06.074.00 | 90 | 1.42.077.11 | 120 | 1.44.058.00 | 175 | 2.01.060.00 | 9 |
| 1.06.075.00 | 90 | 1.43.001.80 | 153 | 1.44.058.00UK | 176 | 2.01.061.00 | 9 |
| 1.06.076.00 | 89 | 1.43.050.00 | 129 | 1.44.058.20 | 175 | 2.01.062.12 | 10 |
| 1.06.077.00 | 89 | 1.43.051.00 | 129 | 1.44.059.00 | 175 | 2.01.063.12 | 10 |

| CODICE/CODE | PAG. | CODICE/CODE | PAG. | CODICE/CODE | PAG. | CODICE/CODE | PAG. |
|-------------|------|-------------|---------|-------------|-----------|-------------|-----------|
| 2.01.064.11 | 11 | 2.02.052.00 | 21 | 2.04.075.10 | 48 | 2.41.061.00 | 109 |
| 2.01.065.11 | 11 | 2.02.054.00 | 29 | 2.04.076.10 | 48 | 2.41.062.00 | 106 |
| 2.01.066.24 | 7 | 2.02.056.00 | 22 | 2.04.077.10 | 48 | 2.41.064.00 | 107 |
| 2.01.067.24 | 7 | 2.02.060.00 | 34 | 2.04.078.00 | 45 | 2.41.065.00 | 107 |
| 2.01.068.25 | 7 | 2.02.062.00 | 34 | 2.04.078.20 | 45 | 2.41.066.00 | 105 |
| 2.01.069.25 | 7 | 2.02.064.00 | 26 | 2.04.079.00 | 45 | 2.41.067.00 | 105 |
| 2.01.072.00 | 11 | 2.02.066.00 | 26 | 2.04.079.20 | 45 | 2.41.068.10 | 108 |
| 2.01.073.00 | 11 | 2.02.066.12 | 26 | 2.04.080.00 | 46 | 2.41.069.10 | 108 |
| 2.01.074.00 | 13 | 2.02.068.00 | 26 | 2.04.080.20 | 46 | 2.41.070.00 | 106 |
| 2.01.075.00 | 13 | 2.02.070.00 | 26 | 2.04.081.00 | 46 | 2.41.072.00 | 106 |
| 2.01.076.00 | 11 | 2.02.180.12 | 16 - 29 | 2.04.081.20 | 46 | 2.41.074.00 | 107 |
| 2.01.077.00 | 11 | 2.02.182.11 | 22 | 2.04.082.10 | 46 | 2.41.076.00 | 113 - 207 |
| 2.01.078.00 | 11 | 2.02.182.12 | 22 | 2.04.083.10 | 46 | 2.41.078.80 | 112 - 215 |
| 2.01.079.00 | 11 | 2.02.184.12 | 25 | 2.04.086.10 | 44 | 2.41.080.00 | 107 |
| 2.01.084.00 | 10 | 2.02.186.12 | 25 | 2.04.087.10 | 44 | 2.41.082.00 | 111 |
| 2.01.084.24 | 10 | 2.02.192.12 | 30 | 2.04.102.10 | 56 | 2.41.084.00 | 111 |
| 2.01.085.00 | 10 | 2.03.010.80 | 253 | 2.04.103.10 | 56 | 2.41.086.19 | 110 |
| 2.01.085.24 | 10 | 2.04.050.10 | 47 | 2.04.104.10 | 48 | 2.41.086.27 | 110 |
| 2.01.086.00 | 10 | 2.04.051.10 | 47 | 2.04.105.10 | 48 | 2.41.087.27 | 110 |
| 2.01.086.25 | 10 | 2.04.052.10 | 47 | 2.04.106.10 | 196 | 2.41.088.00 | 108 |
| 2.01.087.00 | 10 | 2.04.053.10 | 47 | 2.04.107.10 | 196 | 2.41.089.00 | 108 |
| 2.01.087.25 | 10 | 2.04.054.00 | 59 | 2.04.108.10 | 196 | 2.41.092.00 | 110 |
| 2.01.088.00 | 6 | 2.04.054.20 | 59 | 2.04.109.10 | 196 | 2.41.094.00 | 105 |
| 2.01.089.00 | 6 | 2.04.055.00 | 59 | 2.04.110.10 | 196 | 2.41.095.00 | 105 |
| 2.01.090.00 | 7 | 2.04.055.20 | 59 | 2.04.111.10 | 196 | 2.41.096.00 | 108 |
| 2.01.091.00 | 7 | 2.04.056.00 | 46 | 2.04.112.10 | 196 | 2.41.097.00 | 108 |
| 2.01.094.00 | 9 | 2.04.056.20 | 46 | 2.04.113.10 | 196 | 2.41.098.80 | 111 |
| 2.01.095.00 | 9 | 2.04.057.00 | 46 | 2.04.114.10 | 57 | 2.41.100.00 | 104 |
| 2.01.096.00 | 9 | 2.04.057.20 | 46 | 2.04.115.10 | 57 | 2.41.101.00 | 104 |
| 2.01.097.00 | 9 | 2.04.058.10 | 56 | 2.04.116.10 | 47 | 2.41.102.27 | 102 |
| 2.01.098.00 | 10 | 2.04.059.10 | 56 | 2.04.117.10 | 47 | 2.41.103.27 | 102 |
| 2.01.099.00 | 10 | 2.04.060.10 | 49 | 2.04.118.10 | 44 | 2.41.104.27 | 102 |
| 2.01.106.12 | 6 | 2.04.061.10 | 49 | 2.04.119.10 | 44 | 2.41.105.27 | 102 |
| 2.01.107.12 | 6 | 2.04.062.10 | 44 - 49 | 2.04.120.10 | 204 | 2.41.106.00 | 112 |
| 2.01.108.00 | 6 | 2.04.063.10 | 44 - 49 | 2.04.121.10 | 204 | 2.41.106.27 | 112 |
| 2.01.109.00 | 6 | 2.04.064.00 | 59 | 2.05.050.00 | 85 | 2.41.108.12 | 103 |
| 2.01.112.00 | 12 | 2.04.064.22 | 59 | 2.41.048.00 | 103 | 2.41.109.12 | 103 |
| 2.01.113.00 | 12 | 2.04.066.00 | 60 | 2.41.048.25 | 103 | 2.41.110.27 | 102 |
| 2.01.114.00 | 12 | 2.04.066.21 | 60 | 2.41.049.00 | 103 | 2.41.111.27 | 102 |
| 2.01.115.00 | 12 | 2.04.068.00 | 59 | 2.41.049.25 | 103 | 2.41.112.00 | 112 |
| 2.01.122.00 | 12 | 2.04.068.20 | 59 | 2.41.050.00 | 105 | 2.41.112.27 | 112 |
| 2.01.122.24 | 12 | 2.04.069.00 | 59 | 2.41.051.00 | 105 | 2.41.113.00 | 112 |
| 2.01.124.00 | 6 | 2.04.069.20 | 59 | 2.41.054.00 | 104 - 106 | 2.41.113.27 | 112 |
| 2.01.125.00 | 6 | 2.04.070.10 | 54 | 2.41.056.00 | 111 | 2.41.114.12 | 102 |
| 2.01.130.00 | 12 | 2.04.071.10 | 54 | 2.41.058.00 | 112 | 2.41.116.20 | 102 |
| 2.01.131.00 | 12 | 2.04.072.10 | 54 | 2.41.058.27 | 105 | 2.41.118.00 | 111 |
| 2.01.144.10 | 8 | 2.04.073.10 | 54 | 2.41.059.27 | 105 | 2.41.126.25 | 105 |
| 2.01.145.10 | 8 | 2.04.074.10 | 48 | 2.41.060.00 | 109 | 2.41.127.25 | 105 |

| CODICE/CODE | PAG. | CODICE/CODE | PAG. | CODICE/CODE | PAG. | CODICE/CODE | PAG. |
|-------------|-----------|-------------|-----------|-------------|-----------|-------------|------|
| 2.41.130.80 | 109 | 2.42.082.80 | 123 | 2.43.054.81 | 148 | 2.43.122.80 | 147 |
| 2.41.131.80 | 109 | 2.42.084.00 | 121 | 2.43.056.81 | 148 | 2.43.124.80 | 147 |
| 2.41.132.00 | 108 | 2.42.085.00 | 121 | 2.43.058.81 | 148 | 2.43.126.00 | 140 |
| 2.41.132.80 | 107 | 2.42.086.00 | 121 | 2.43.060.81 | 148 | 2.43.128.81 | 155 |
| 2.41.133.00 | 108 | 2.42.087.00 | 121 | 2.43.062.40 | 137 | 2.43.129.81 | 155 |
| 2.41.133.80 | 107 | 2.42.088.00 | 121 | 2.43.064.18 | 137 | 2.43.130.80 | 134 |
| 2.41.326.00 | 133 | 2.42.089.00 | 121 | 2.43.068.00 | 142 | 2.43.131.80 | 134 |
| 2.41.326.18 | 133 | 2.42.090.00 | 121 | 2.43.068.24 | 142 | 2.43.132.80 | 132 |
| 2.41.328.80 | 110 | 2.42.091.00 | 121 | 2.43.068.24 | 142 | 2.43.134.80 | 154 |
| 2.41.329.80 | 110 | 2.42.092.00 | 125 | 2.43.070.00 | 142 | 2.43.136.80 | 154 |
| 2.41.330.00 | 108 | 2.42.094.00 | 123 | 2.43.072.00 | 141 | 2.43.138.80 | 154 |
| 2.41.331.00 | 108 | 2.42.094.80 | 215 | 2.43.072.18 | 140 - 141 | 2.43.140.80 | 133 |
| 2.41.332.80 | 107 | 2.42.095.00 | 123 | 2.43.072.18 | 142 | 2.43.141.80 | 133 |
| 2.41.333.00 | 109 | 2.42.096.00 | 124 | 2.43.072.22 | 140 - 141 | 2.43.142.00 | 135 |
| 2.41.334.00 | 109 | 2.42.097.00 | 124 | 2.43.072.22 | 142 | 2.43.142.24 | 136 |
| 2.41.336.00 | 127 | 2.42.098.80 | 128 | 2.43.072.25 | 140 - 141 | 2.43.142.26 | 136 |
| 2.41.337.00 | 127 | 2.42.100.80 | 126 | 2.43.072.25 | 142 | 2.43.144.00 | 135 |
| 2.42.050.00 | 106 | 2.42.102.00 | 122 | 2.43.074.00 | 141 | 2.43.145.00 | 135 |
| 2.42.052.00 | 127 | 2.42.102.24 | 122 | 2.43.076.81 | 155 | 2.43.146.00 | 136 |
| 2.42.053.00 | 127 | 2.42.104.00 | 118 | 2.43.077.81 | 155 | 2.43.147.00 | 136 |
| 2.42.054.00 | 127 | 2.42.106.00 | 119 | 2.43.078.81 | 155 | 2.43.148.00 | 136 |
| 2.42.055.00 | 127 | 2.42.108.80 | 126 | 2.43.079.81 | 155 | 2.43.150.80 | 157 |
| 2.42.056.11 | 124 | 2.42.110.80 | 126 | 2.43.080.00 | 141 | 2.43.151.80 | 157 |
| 2.42.058.80 | 123 | 2.42.128.80 | 126 | 2.43.082.00 | 142 | 2.43.152.80 | 157 |
| 2.42.060.12 | 117 | 2.42.134.00 | 114 | 2.43.084.81 | 159 | 2.43.153.80 | 157 |
| 2.42.061.12 | 117 | 2.42.135.00 | 124 | 2.43.085.81 | 159 | 2.43.154.80 | 157 |
| 2.42.062.80 | 126 | 2.42.136.00 | 122 | 2.43.086.81 | 159 | 2.43.155.80 | 157 |
| 2.42.066.00 | 114 | 2.42.137.80 | 125 | 2.43.087.81 | 159 | 2.43.156.80 | 157 |
| 2.42.066.24 | 114 - 115 | 2.42.138.80 | 127 | 2.43.088.00 | 144 | 2.43.158.80 | 146 |
| 2.42.068.12 | 118 | 2.42.139.80 | 127 | 2.43.088.26 | 144 | 2.43.160.80 | 146 |
| 2.42.068.15 | 118 | 2.42.140.80 | 127 | 2.43.089.00 | 144 | 2.43.162.80 | 146 |
| 2.42.069.12 | 118 | 2.42.141.80 | 127 | 2.43.090.80 | 151 | 2.43.164.80 | 146 |
| 2.42.069.15 | 118 | 2.42.142.00 | 123 | 2.43.091.80 | 129 | 2.43.166.80 | 146 |
| 2.42.070.00 | 115 | 2.42.144.00 | 114 | 2.43.092.80 | 151 | 2.43.168.80 | 146 |
| 2.42.072.00 | 122 | 2.42.145.00 | 114 | 2.43.094.80 | 151 | 2.43.170.80 | 147 |
| 2.42.073.00 | 122 | 2.43.040.00 | 134 | 2.43.096.80 | 151 | 2.43.172.80 | 147 |
| 2.42.074.00 | 120 | 2.43.044.00 | 139 | 2.43.098.00 | 137 | 2.43.174.80 | 147 |
| 2.42.075.00 | 120 | 2.43.044.10 | 139 - 140 | 2.43.098.24 | 136 - 137 | 2.43.176.80 | 147 |
| 2.42.076.00 | 119 - 120 | 2.43.045.00 | 139 | 2.43.099.00 | 136 | 2.43.178.80 | 147 |
| 2.42.076.17 | 164 | 2.43.046.00 | 140 | 2.43.100.00 | 137 | 2.43.180.80 | 147 |
| 2.42.076.18 | 114 - 119 | 2.43.048.00 | 116 - 134 | 2.43.100.24 | 137 | 2.43.182.00 | 143 |
| 2.42.076.18 | 125 | 2.43.048.11 | 134 | 2.43.102.81 | 158 | 2.43.182.21 | 143 |
| 2.42.078.00 | 114 - 125 | 2.43.048.18 | 116 - 134 | 2.43.103.81 | 158 | 2.43.184.00 | 143 |
| 2.42.078.17 | 164 | 2.43.048.80 | 149 | 2.43.112.00 | 139 | 2.43.184.25 | 143 |
| 2.42.078.18 | 120 | 2.43.050.00 | 140 | 2.43.114.00 | 139 | 2.43.186.80 | 156 |
| 2.42.080.00 | 120 | 2.43.051.00 | 140 | 2.43.116.80 | 143 | 2.43.186.81 | 156 |
| 2.42.080.80 | 110 | 2.43.052.80 | 132 | 2.43.118.80 | 143 | 2.43.186.88 | 156 |
| 2.42.081.00 | 120 | 2.43.052.81 | 148 | 2.43.120.80 | 143 | 2.43.187.80 | 156 |

| CODICE/CODE | PAG. | CODICE/CODE | PAG. | CODICE/CODE | PAG. | CODICE/CODE | PAG. |
|-------------|------|-------------|------|-------------|------|-------------|-----------|
| 2.43.187.88 | 156 | 2.43.244.80 | 149 | 2.43.362.80 | 160 | 2.44.062.10 | 189 |
| 2.43.188.80 | 156 | 2.43.246.80 | 150 | 2.43.364.80 | 161 | 2.44.062.18 | 189 |
| 2.43.188.88 | 156 | 2.43.248.00 | 136 | 2.43.366.80 | 161 | 2.44.063.00 | 189 |
| 2.43.189.80 | 156 | 2.43.250.00 | 136 | 2.43.368.80 | 161 | 2.44.063.10 | 189 |
| 2.43.189.88 | 156 | 2.43.252.00 | 136 | 2.43.369.80 | 161 | 2.44.064.00 | 176 |
| 2.43.190.80 | 156 | 2.43.254.80 | 150 | 2.43.370.80 | 161 | 2.44.064.20 | 176 |
| 2.43.190.88 | 156 | 2.43.255.80 | 150 | 2.43.371.80 | 161 | 2.44.065.00 | 176 |
| 2.43.191.80 | 156 | 2.43.256.80 | 150 | 2.43.372.80 | 161 | 2.44.065.20 | 176 |
| 2.43.191.88 | 156 | 2.43.257.80 | 150 | 2.43.373.80 | 161 | 2.44.066.00 | 209 |
| 2.43.192.80 | 156 | 2.43.258.80 | 150 | 2.43.374.80 | 161 | 2.44.066.20 | 209 |
| 2.43.193.80 | 156 | 2.43.260.80 | 129 | 2.43.375.80 | 161 | 2.44.066.30 | 210 |
| 2.43.194.80 | 143 | 2.43.262.80 | 163 | 2.43.376.25 | 161 | 2.44.066.80 | 210 |
| 2.43.195.80 | 151 | 2.43.263.80 | 163 | 2.43.377.25 | 162 | 2.44.067.00 | 209 |
| 2.43.195.81 | 151 | 2.43.264.80 | 163 | 2.43.378.80 | 162 | 2.44.067.80 | 210 |
| 2.43.196.80 | 144 | 2.43.272.80 | 149 | 2.43.379.80 | 162 | 2.44.068.00 | 218 |
| 2.43.197.80 | 145 | 2.43.274.80 | 149 | 2.43.380.80 | 162 | 2.44.068.20 | 218 |
| 2.43.198.80 | 144 | 2.43.276.80 | 149 | 2.43.381.80 | 162 | 2.44.069.00 | 218 |
| 2.43.199.80 | 145 | 2.43.280.00 | 135 | 2.43.382.80 | 162 | 2.44.069.20 | 218 |
| 2.43.200.80 | 144 | 2.43.292.80 | 149 | 2.43.383.80 | 162 | 2.44.070.00 | 172 |
| 2.43.201.80 | 145 | 2.43.320.00 | 135 | 2.43.384.80 | 163 | 2.44.070.20 | 172 |
| 2.43.202.80 | 154 | 2.43.322.00 | 135 | 2.43.386.80 | 163 | 2.44.072.10 | 174 |
| 2.43.204.80 | 154 | 2.43.325.00 | 137 | 2.43.387.80 | 163 | 2.44.073.10 | 174 |
| 2.43.206.80 | 154 | 2.43.326.00 | 131 | 2.43.388.80 | 163 | 2.44.074.00 | 216 |
| 2.43.208.80 | 153 | 2.43.327.00 | 131 | 2.43.389.80 | 163 | 2.44.074.20 | 216 |
| 2.43.210.80 | 153 | 2.43.328.00 | 132 | 2.43.390.80 | 163 | 2.44.075.01 | 216 |
| 2.43.212.80 | 153 | 2.43.329.00 | 132 | 2.43.391.80 | 163 | 2.44.076.01 | 214 |
| 2.43.214.80 | 153 | 2.43.330.80 | 134 | 2.44.040.00 | 172 | 2.44.076.10 | 190 |
| 2.43.216.80 | 154 | 2.43.331.80 | 134 | 2.44.046.20 | 167 | 2.44.076.20 | 214 |
| 2.43.218.00 | 125 | 2.43.332.80 | 134 | 2.44.048.00 | 172 | 2.44.077.10 | 190 |
| 2.43.220.00 | 138 | 2.43.334.80 | 132 | 2.44.049.00 | 172 | 2.44.078.00 | 188 |
| 2.43.220.22 | 138 | 2.43.335.80 | 132 | 2.44.050.10 | 172 | 2.44.078.20 | 188 - 191 |
| 2.43.220.24 | 138 | 2.43.336.80 | 135 | 2.44.051.10 | 172 | 2.44.079.00 | 188 |
| 2.43.220.25 | 138 | 2.43.338.80 | 133 | 2.44.052.10 | 172 | 2.44.079.01 | 188 |
| 2.43.221.00 | 138 | 2.43.339.80 | 133 | 2.44.053.10 | 172 | 2.44.079.20 | 188 - 191 |
| 2.43.222.00 | 138 | 2.43.340.80 | 133 | 2.44.054.10 | 171 | 2.44.081.01 | 188 |
| 2.43.223.00 | 138 | 2.43.342.80 | 159 | 2.44.055.10 | 171 | 2.44.082.80 | 212 |
| 2.43.224.26 | 138 | 2.43.344.80 | 159 | 2.44.056.00 | 168 | 2.44.083.80 | 212 |
| 2.43.226.00 | 138 | 2.43.346.80 | 159 | 2.44.056.10 | 168 | 2.44.084.80 | 215 |
| 2.43.228.00 | 138 | 2.43.348.80 | 160 | 2.44.056.18 | 168 | 2.44.086.80 | 215 |
| 2.43.230.00 | 138 | 2.43.350.80 | 160 | 2.44.057.00 | 168 | 2.44.087.80 | 215 |
| 2.43.232.80 | 158 | 2.43.352.80 | 160 | 2.44.057.10 | 168 | 2.44.088.80 | 215 |
| 2.43.234.80 | 158 | 2.43.354.80 | 160 | 2.44.058.10 | 168 | 2.44.089.80 | 215 |
| 2.43.235.80 | 158 | 2.43.355.80 | 160 | 2.44.059.10 | 168 | 2.44.092.80 | 214 |
| 2.43.236.80 | 158 | 2.43.356.80 | 160 | 2.44.060.00 | 173 | 2.44.094.80 | 214 |
| 2.43.237.80 | 158 | 2.43.357.80 | 160 | 2.44.060.10 | 173 | 2.44.096.80 | 214 |
| 2.43.238.80 | 149 | 2.43.358.80 | 160 | 2.44.061.00 | 173 | 2.44.098.80 | 214 |
| 2.43.240.80 | 149 | 2.43.359.80 | 160 | 2.44.061.10 | 173 | 2.44.100.80 | 214 |
| 2.43.242.80 | 149 | 2.43.360.80 | 160 | 2.44.062.00 | 189 | 2.44.102.80 | 214 |

| CODICE/CODE | PAG. | CODICE/CODE | PAG. | CODICE/CODE | PAG. | CODICE/CODE | PAG. |
|-------------|------|-------------|-----------|-------------|------|-------------|------|
| 2.44.104.00 | 218 | 2.44.174.20 | 185 - 186 | 2.44.224.20 | 211 | 2.44.281.80 | 212 |
| 2.44.105.00 | 218 | 2.44.174.20 | 201 | 2.44.225.00 | 211 | 2.44.282.80 | 212 |
| 2.44.106.00 | 208 | 2.44.175.01 | 201 | 2.44.225.20 | 211 | 2.44.283.80 | 212 |
| 2.44.106.20 | 208 | 2.44.176.00 | 185 | 2.44.226.00 | 221 | 2.44.290.00 | 202 |
| 2.44.107.01 | 208 | 2.44.177.01 | 185 | 2.44.226.20 | 221 | 2.44.290.20 | 202 |
| 2.44.107.21 | 208 | 2.44.178.00 | 198 | 2.44.227.00 | 221 | 2.44.291.01 | 202 |
| 2.44.110.00 | 167 | 2.44.178.20 | 198 - 202 | 2.44.227.20 | 221 | 2.44.292.00 | 202 |
| 2.44.111.00 | 167 | 2.44.178.20 | 203 | 2.44.228.00 | 169 | 2.44.292.20 | 202 |
| 2.44.112.00 | 204 | 2.44.179.01 | 198 | 2.44.228.20 | 169 | 2.44.293.01 | 202 |
| 2.44.113.00 | 204 | 2.44.180.00 | 198 | 2.44.229.00 | 169 | 2.44.294.10 | 170 |
| 2.44.118.00 | 191 | 2.44.181.01 | 198 | 2.44.229.20 | 169 | 2.44.295.10 | 170 |
| 2.44.118.20 | 191 | 2.44.182.00 | 190 | 2.44.232.00 | 167 | 2.44.296.00 | 191 |
| 2.44.119.01 | 191 | 2.44.182.20 | 189 - 190 | 2.44.232.20 | 167 | 2.44.297.00 | 191 |
| 2.44.120.00 | 186 | 2.44.183.01 | 190 | 2.44.234.00 | 235 | 2.44.298.00 | 222 |
| 2.44.121.00 | 186 | 2.44.184.00 | 189 | 2.44.238.20 | 211 | 2.44.298.20 | 222 |
| 2.44.123.01 | 186 | 2.44.185.01 | 189 | 2.44.238.80 | 211 | 2.44.299.00 | 222 |
| 2.44.124.00 | 192 | 2.44.186.00 | 203 | 2.44.239.80 | 211 | 2.44.299.20 | 222 |
| 2.44.124.20 | 192 | 2.44.187.01 | 203 | 2.44.239.81 | 211 | 2.44.300.10 | 192 |
| 2.44.125.00 | 192 | 2.44.188.00 | 202 | 2.44.250.80 | 217 | 2.44.301.10 | 192 |
| 2.44.127.01 | 192 | 2.44.189.01 | 202 | 2.44.252.80 | 217 | 2.44.302.10 | 204 |
| 2.44.128.00 | 207 | 2.44.190.00 | 225 | 2.44.254.00 | 217 | 2.44.303.10 | 204 |
| 2.44.128.21 | 207 | 2.44.190.20 | 225 | 2.44.254.20 | 217 | 2.44.306.10 | 205 |
| 2.44.130.00 | 207 | 2.44.191.00 | 225 | 2.44.255.01 | 217 | 2.44.307.10 | 205 |
| 2.44.132.00 | 207 | 2.44.192.81 | 217 | 2.44.258.00 | 225 | 2.44.308.10 | 204 |
| 2.44.134.00 | 207 | 2.44.193.81 | 217 | 2.44.258.20 | 225 | 2.44.309.10 | 204 |
| 2.44.134.11 | 207 | 2.44.194.80 | 215 | 2.44.260.10 | 196 | 2.44.310.10 | 205 |
| 2.44.136.00 | 207 | 2.44.195.80 | 215 | 2.44.261.10 | 196 | 2.44.311.10 | 205 |
| 2.44.136.25 | 207 | 2.44.196.80 | 215 | 2.44.262.00 | 210 | 2.44.314.10 | 171 |
| 2.44.138.00 | 179 | 2.44.198.80 | 215 | 2.44.263.00 | 210 | 2.44.315.10 | 171 |
| 2.44.139.01 | 179 | 2.44.204.80 | 209 | 2.44.263.01 | 210 | 2.44.316.00 | 171 |
| 2.44.140.80 | 206 | 2.44.206.10 | 168 | 2.44.264.10 | 171 | 2.44.317.00 | 171 |
| 2.44.144.80 | 206 | 2.44.207.10 | 168 | 2.44.265.10 | 171 | 2.44.318.10 | 195 |
| 2.44.148.80 | 206 | 2.44.208.00 | 209 | 2.44.266.10 | 173 | 2.44.319.10 | 195 |
| 2.44.152.80 | 206 | 2.44.209.01 | 209 | 2.44.267.10 | 173 | 2.44.320.00 | 222 |
| 2.44.156.80 | 205 | 2.44.210.80 | 213 | 2.44.268.80 | 216 | 2.44.320.20 | 222 |
| 2.44.160.80 | 205 | 2.44.212.80 | 214 | 2.44.270.80 | 216 | 2.44.324.00 | 189 |
| 2.44.162.80 | 206 | 2.44.213.80 | 214 | 2.44.271.80 | 216 | 2.44.324.70 | 189 |
| 2.44.164.00 | 171 | 2.44.214.10 | 204 | 2.44.272.10 | 170 | 2.44.325.01 | 189 |
| 2.44.165.00 | 171 | 2.44.215.10 | 204 | 2.44.273.10 | 170 | 2.44.326.20 | 189 |
| 2.44.166.00 | 207 | 2.44.216.00 | 183 | 2.44.276.00 | 188 | 2.44.327.00 | 191 |
| 2.44.167.00 | 207 | 2.44.216.20 | 183 - 184 | 2.44.276.10 | 188 | 2.44.328.20 | 201 |
| 2.44.168.00 | 207 | 2.44.217.00 | 183 | 2.44.276.70 | 188 | 2.44.328.80 | 201 |
| 2.44.169.00 | 207 | 2.44.217.20 | 183 - 184 | 2.44.277.01 | 188 | 2.44.328.81 | 201 |
| 2.44.170.00 | 207 | 2.44.218.00 | 184 | 2.44.278.00 | 173 | 2.44.329.20 | 201 |
| 2.44.171.00 | 207 | 2.44.219.00 | 184 | 2.44.278.10 | 173 | 2.44.329.81 | 201 |
| 2.44.172.00 | 191 | 2.44.220.10 | 174 | 2.44.279.00 | 173 | 2.44.330.50 | 213 |
| 2.44.173.01 | 191 | 2.44.221.10 | 174 | 2.44.279.10 | 173 | 2.44.330.80 | 213 |
| 2.44.174.00 | 201 | 2.44.224.00 | 211 | 2.44.280.80 | 212 | 2.44.331.80 | 213 |

| CODICE/CODE | PAG. | CODICE/CODE | PAG. | CODICE/CODE | PAG. | CODICE/CODE | PAG. |
|-------------|-----------|-------------|------|-------------|-----------|-------------|-----------|
| 2.44.332.20 | 166 | 2.48.050.80 | 240 | 3.47.050.00 | 252 | 3.49.092.00 | 98 - 99 |
| 2.44.332.80 | 166 | 2.48.052.80 | 240 | 3.47.052.00 | 252 | 3.49.092.00 | 229 - 247 |
| 2.44.333.20 | 166 | 2.48.058.80 | 240 | 3.47.054.00 | 252 | 3.49.094.00 | 250 |
| 2.44.333.81 | 166 | 2.48.060.80 | 240 | 3.47.058.00 | 251 | 3.49.095.00 | 250 |
| 2.44.334.20 | 187 | 2.48.062.80 | 241 | 3.47.062.00 | 251 | 3.49.096.00 | 165 - 166 |
| 2.44.334.80 | 187 | 2.48.066.00 | 241 | 3.47.064.00 | 251 | 3.49.096.00 | 167 - 180 |
| 2.44.335.20 | 187 | 2020001040 | 97 | 3.47.070.80 | 252 | 3.49.096.00 | 181 - 182 |
| 2.44.335.81 | 187 | 2020001067 | 96 | 3.47.072.80 | 252 | 4.14.000.03 | 261 |
| 2.44.336.80 | 188 | 2020001069 | 96 | 3.47.074.80 | 253 | 4.14.000.04 | 261 |
| 2.44.337.81 | 188 | 2020001105 | 94 | 3.49.050.00 | 248 | 4.14.000.07 | 261 |
| 2.45.050.00 | 231 | 2020001107 | 94 | 3.49.052.00 | 248 | 4.14.000.08 | 261 |
| 2.45.051.00 | 231 | 2020101040 | 97 | 3.49.054.00 | 248 | 4.42.056.07 | 260 |
| 2.45.052.00 | 231 | 2020101067 | 96 | 3.49.056.00 | 249 | 4.42.056.80 | 123 |
| 2.45.053.00 | 231 | 2020101069 | 96 | 3.49.056.50 | 249 | 4.42.130.00 | 260 |
| 2.45.054.00 | 232 | 2020101105 | 94 | 3.49.057.00 | 249 | 4.42.743.00 | 259 |
| 2.45.056.00 | 232 | 2020101107 | 94 | 3.49.057.50 | 249 | 4.42.956.00 | 259 |
| 2.45.058.00 | 232 | 2021001019 | 75 | 3.49.058.00 | 169 - 177 | 4.43.058.80 | 129 |
| 2.45.060.00 | 233 | 2021001025 | 60 | 3.49.058.00 | 178 -249 | 4.44.070.00 | 186 |
| 2.45.062.00 | 233 | 2021001031 | 61 | 3.49.060.00 | 169 - 177 | 4.44.071.00 | 186 |
| 2.45.064.00 | 234 | 2021001037 | 73 | 3.49.060.00 | 180 -250 | 4.44.071.01 | 186 |
| 2.45.066.00 | 233 | 2021001038 | 73 | 3.49.063.00 | 247 | 4.44.084.01 | 185 |
| 2.45.068.80 | 234 | 2021001045 | 64 | 3.49.064.00 | 247 | 4.44.085.01 | 185 |
| 2.45.070.80 | 233 | 2021001046 | 75 | 3.49.066.00 | 247 | 4.44.098.80 | 173 |
| 2.45.072.80 | 233 | 2021001047 | 75 | 3.49.070.00 | 175- 176 | 4.44.100.80 | 173 |
| 2.45.074.80 | 234 | 2021001049 | 73 | 3.49.070.00 | 178 -182 | 4.44.102.80 | 173 |
| 2.45.076.00 | 234 | 2021001050 | 61 | 3.49.070.00 | 184-186 | 4.44.104.80 | 173 |
| 2.45.078.80 | 235 | 2021001052 | 61 | 3.49.070.00 | 187 - 188 | 4.44.112.80 | 213 |
| 2.47.050.00 | 242 | 2021001102 | 60 | 3.49.070.00 | 190 - 195 | 4.44.113.80 | 213 |
| 2.47.050.23 | 242 - 243 | 2021001104 | 60 | 3.49.070.00 | 197 - 198 | 4.46.054.90 | 237 |
| 2.47.050.80 | 242 | 2021001105 | 60 | 3.49.070.00 | 199 - 200 | 4.46.054.91 | 237 |
| 2.47.051.00 | 242 | 2021001119 | 61 | 3.49.070.00 | 202 - 209 | 4.46.054.92 | 237 |
| 2.47.052.00 | 242 | 2021101019 | 75 | 3.49.070.00 | 210 - 212 | 4.46.056.90 | 237 |
| 2.47.052.80 | 243 | 2021101025 | 60 | 3.49.070.00 | 219 - 223 | 4.46.056.91 | 237 |
| 2.47.054.00 | 243 | 2021101031 | 61 | 3.49.070.00 | 250 | 4.46.056.92 | 237 |
| 2.47.054.80 | 243 | 2021101037 | 73 | 3.49.073.50 | 249 | 4.46.058.90 | 236 |
| 2.47.068.00 | 246 | 2021101038 | 73 | 3.49.075.00 | 248 | 4.46.058.91 | 236 |
| 2.47.072.00 | 246 | 2021101045 | 64 | 3.49.076.00 | 36 | 4.46.058.92 | 236 |
| 2.47.074.00 | 246 | 2021101046 | 75 | 3.49.078.00 | 36 | 4.46.062.90 | 236 |
| 2.47.076.00 | 246 | 2021101047 | 75 | 3.49.080.00 | 208 - 209 | 4.46.062.91 | 236 |
| 2.47.078.00 | 246 | 2021101049 | 73 | 3.49.080.00 | 218 - 220 | 4.46.062.92 | 236 |
| 2.47.088.80 | 113 | 2021101050 | 61 | 3.49.080.00 | 224 - 250 | 4.46.064.90 | 237 |
| 2.47.090.80 | 113 | 2021101052 | 61 | 3.49.082.00 | 169 - 175 | 4.46.064.91 | 237 |
| 2.47.098.80 | 243 | 2021101102 | 60 | 3.49.084.00 | 248 | 4.46.064.92 | 237 |
| 2.47.100.80 | 244 | 2021101104 | 60 | 3.49.086.00 | 249 | 4.46.066.90 | 238 |
| 2.47.102.80 | 244 | 2021101105 | 60 | 3.49.088.00 | 216 | 4.46.066.91 | 238 |
| 2.47.104.80 | 244 | 2021101119 | 61 | 3.49.089.00 | 216 | 4.46.066.92 | 238 |
| 2.47.106.80 | 244 | 2024001003 | 44 | 3.49.090.00 | 179 - 186 | 4.46.068.90 | 238 |
| 2.47.108.80 | 245 | 2024101003 | 44 | 3.49.090.00 | 189 - 211 | 4.46.068.91 | 238 |

| CODICE/CODE | PAG. | CODICE/CODE | PAG. | CODICE/CODE | PAG. | CODICE/CODE | PAG. |
|-------------|------|-------------|--------------|-------------|---------|-------------|-----------|
| 4.46.068.92 | 238 | 5.02.117.00 | 26 | 5.04.111.00 | 62 | 5.41.070.00 | 103 |
| 4.46.070.90 | 238 | 5.02.118.00 | 26 | 5.04.112.00 | 50 | 5.41.071.00 | 103 |
| 4.46.070.91 | 238 | 5.02.119.00 | 26 | 5.04.113.00 | 50 | 5.41.072.00 | 103 |
| 4.46.070.92 | 238 | 5.02.120.80 | 28 | 5.04.134.00 | 77 | 5.41.073.00 | 103 |
| 4.46.072.90 | 238 | 5.02.121.80 | 28 | 5.04.135.00 | 77 | 5.41.086.00 | 104 |
| 4.46.074.90 | 239 | 5.02.122.80 | 30 | 5.04.154.00 | 56 | 5.41.087.00 | 104 |
| 4.46.076.90 | 239 | 5.02.123.80 | 30 | 5.04.155.00 | 56 | 5.42.050.00 | 119 |
| 4.46.40.01 | 255 | 5.02.124.80 | 30 | 5.04.172.00 | 44 - 49 | 5.42.054.00 | 116 |
| 4.46.40.02 | 255 | 5.02.125.80 | 30 | 5.04.173.00 | 44 - 49 | 5.42.055.00 | 116 |
| 4.46.40.04 | 255 | 5.02.126.00 | 30 | 5.04.180.00 | 43 - 74 | 5.42.056.12 | 116 |
| 4.46.40.05 | 255 | 5.02.127.00 | 30 | 5.04.181.00 | 43 - 74 | 5.42.057.12 | 116 |
| 4.46.40.60 | 258 | 5.02.128.00 | 32 | 5.04.182.00 | 55 | 5.42.058.12 | 116 |
| 4.46.40.70 | 258 | 5.02.129.00 | 32 | 5.04.182.19 | 55 | 5.42.059.12 | 116 |
| 4.46.50.15 | 256 | 5.02.130.80 | 32 | 5.04.183.00 | 55 | 5.42.062.00 | 124 |
| 4.46.50.40 | 256 | 5.02.131.80 | 32 | 5.04.183.19 | 55 | 5.42.062.99 | 124 |
| 4.46.50.60 | 256 | 5.02.132.80 | 32 | 5.04.190.00 | 37 | 5.42.063.00 | 124 |
| 4.46.50.70 | 257 | 5.02.133.80 | 32 | 5.04.191.00 | 37 | 5.42.065.00 | 124 |
| 4.46.50.80 | 257 | 5.02.134.00 | 33 | 5.04.192.00 | 37 | 5.42.066.12 | 31 |
| 4.46.50.90 | 257 | 5.02.135.00 | 33 | 5.04.193.00 | 37 | 5.42.067.12 | 31 |
| 4.46.51.00 | 257 | 5.02.136.00 | 33 | 5.04.196.00 | 48 | 5.42.068.12 | 31 |
| 4.46.60.01 | 257 | 5.02.137.00 | 33 | 5.04.197.00 | 48 | 5.42.069.12 | 31 |
| 4.46.60.02 | 258 | 5.02.138.00 | 33 | 5.04.200.00 | 55 | 5.42.070.00 | 120 |
| 4.46.70.01 | 258 | 5.02.139.00 | 33 | 5.04.201.00 | 55 | 5.42.072.80 | 126 |
| 4.46.71.01 | 255 | 5.02.140.00 | 33 | 5.04.208.10 | 77 | 5.42.076.80 | 128 |
| 4.46.71.03 | 256 | 5.02.141.00 | 33 | 5.04.209.10 | 77 | 5.42.082.80 | 122 |
| 4.46.71.05 | 256 | 5.02.142.00 | 33 | 5.04.214.00 | 64 | 5.43.054.00 | 139 |
| 4.46.79.57 | 248 | 5.02.143.00 | 33 | 5.04.215.00 | 64 | 5.43.056.00 | 114 - 125 |
| 4.55.324.11 | 260 | 5.02.144.80 | 36 | 5.04.216.00 | 54 | 5.43.058.00 | 125 |
| 4.55.324.22 | 261 | 5.02.145.80 | 36 | 5.04.217.00 | 54 | 5.43.060.00 | 133 |
| 5.01.054.00 | 11 | 5.02.146.80 | 35 | 5.04.250.00 | 61 | 5.43.062.00 | 130 |
| 5.01.055.00 | 11 | 5.02.147.80 | 35 | 5.04.251.00 | 61 | 5.43.063.00 | 130 |
| 5.02.050.12 | 22 | 5.02.148.80 | 35 | 5.04.254.00 | 57 | 5.44.060.00 | 184 |
| 5.02.051.12 | 22 | 5.02.149.80 | 35 | 5.04.255.00 | 57 | 5.44.060.20 | 184 - 187 |
| 5.02.054.12 | 22 | 5.04.052.00 | 47 | 5.04.256.00 | 57 | 5.44.061.00 | 184 |
| 5.02.055.12 | 22 | 5.04.053.00 | 47 | 5.04.257.00 | 57 | 5.44.061.20 | 184 - 187 |
| 5.02.076.00 | 25 | 5.04.056.00 | 56 | 5.04.258.00 | 50 | 5.44.062.00 | 219 |
| 5.02.077.00 | 25 | 5.04.057.00 | 56 | 5.04.259.00 | 50 | 5.44.062.20 | 219 |
| 5.02.082.00 | 25 | 5.04.068.00 | 56 | 5.06.050.00 | 83 | 5.44.063.00 | 219 |
| 5.02.083.00 | 25 | 5.04.069.00 | 56 | 5.06.068.00 | 92 | 5.44.063.20 | 219 |
| 5.02.100.12 | 29 | 5.04.070.00 | 47 | 5.06.069.00 | 92 | 5.44.066.00 | 197 |
| 5.02.101.12 | 29 | 5.04.071.00 | 47 | 5.41.050.00 | 104 | 5.44.066.20 | 197 |
| 5.02.102.12 | 32 | 5.04.084.00 | 55 | 5.41.051.00 | 104 | 5.44.067.00 | 197 |
| 5.02.103.12 | 32 | 5.04.085.00 | 55 | 5.41.054.00 | 104 | 5.44.068.00 | 168 |
| 5.02.106.80 | 15 | 5.04.086.00 | 37 - 56 - 62 | 5.41.055.00 | 104 | 5.44.068.19 | 168 |
| 5.02.107.80 | 15 | 5.04.087.00 | 37 - 56 - 62 | 5.41.062.00 | 109 | 5.44.069.00 | 168 |
| 5.02.110.80 | 25 | 5.04.102.00 | 50 | 5.41.063.00 | 109 | 5.44.069.19 | 168 |
| 5.02.111.80 | 25 | 5.04.103.00 | 50 | 5.41.068.00 | 103 | 5.44.070.00 | 190 |
| 5.02.116.00 | 26 | 5.04.110.00 | 62 | 5.41.069.00 | 103 | 5.44.070.20 | 190 - 199 |

| CODICE/CODE | PAG. | CODICE/CODE | PAG. | CODICE/CODE | PAG. | CODICE/CODE | PAG. |
|-------------|-----------|-------------|-----------|--------------|-----------|---------------|------|
| 5.44.071.01 | 190 | 5.44.105.01 | 181 | 5.44.139.00 | 194-195 | 68.5.752.025 | 264 |
| 5.44.071.20 | 190 - 199 | 5.44.105.20 | 181 - 182 | 5.44.140.00 | 194-195 | 68.5.753.025 | 271 |
| 5.44.072.00 | 199 | 5.44.106.00 | 182 | 5.44.141.00 | 194 | 68.5.791.025 | 271 |
| 5.44.073.01 | 199 | 5.44.106.70 | 182 | 5.47.050.80 | 245 | 68.5.793.025 | 271 |
| 5.44.074.00 | 219 | 5.44.107.00 | 182 | 5.47.051.80 | 245 | 68.5.796.025 | 270 |
| 5.44.074.20 | 219 | 5.44.107.01 | 182 | 5.47.052.80 | 245 | 68.5.800.025 | 264 |
| 5.44.075.00 | 219 | 5.44.108.20 | 197-203 | 5.47.100.00 | 253 | 68.5.801.025 | 264 |
| 5.44.075.20 | 219 | 5.44.108.80 | 197-203 | 6.49.052.00 | 169 - 175 | 68.6.152.025 | 271 |
| 5.44.076.00 | 190 | 5.44.108.81 | 197 | 6.49.052.00 | 250 | 68.6.153.031 | 272 |
| 5.44.077.00 | 190 | 5.44.109.80 | 197-203 | 6.49.054.00 | 250 | 68.6.154.030 | 273 |
| 5.44.080.00 | 174 | 5.44.110.00 | 200 | 6.49.055.00 | 183 - 251 | 68.6.154.031 | 273 |
| 5.44.081.00 | 174 | 5.44.111.00 | 200 | 60.700.00 | 254 | 68.6.155.030 | 273 |
| 5.44.084.00 | 174 | 5.44.112.20 | 199-200 | 60.710.00 | 254 | 68.6.155.031 | 273 |
| 5.44.086.00 | 174 | 5.44.112.80 | 200 | 67.0103 | 270 | 68.6.398.025 | 272 |
| 5.44.088.00 | 169 | 5.44.113.20 | 199-200 | 67.0107 | 270 | 68.6.399.030 | 273 |
| 5.44.089.00 | 169 | 5.44.113.81 | 200 | 67.0657 | 265 | 68.6.399.031 | 273 |
| 5.44.090.00 | 165 | 5.44.114.80 | 199 | 67.0658 | 265 | 68.6.418.025 | 272 |
| 5.44.090.20 | 165 | 5.44.115.80 | 199 | 67.1032.01 | 266 | 68.6.420.025 | 264 |
| 5.44.090.70 | 165 | 5.44.115.81 | 199 | 67.1033.01 | 266 | 68.6.622.000 | 269 |
| 5.44.091.01 | 165 | 5.44.116.00 | 187 | 67.1067 | 267 | 68.7.417.V44Q | 267 |
| 5.44.091.20 | 165 | 5.44.117.00 | 187 | 67.1068 | 267 | 68.7.417.V45Q | 267 |
| 5.44.092.00 | 165 | 5.44.118.20 | 203 | 67.1069 | 266 | 68.7.418.V44Q | 267 |
| 5.44.092.70 | 165 | 5.44.118.80 | 203 | 67.1070 | 266 | 68.7.418.V45Q | 267 |
| 5.44.093.01 | 165 | 5.44.119.80 | 203 | 67.1073 | 267 | 68.7.517.020 | 269 |
| 5.44.094.20 | 166 - 167 | 5.44.119.81 | 203 | 67.1074 | 267 | 68.7.521.V45 | 269 |
| 5.44.094.80 | 166 | 5.44.120.80 | 225 | 67.1075 | 267 | 68.7.522.V45 | 269 |
| 5.44.095.20 | 166 - 167 | 5.44.121.80 | 225 | 67.1076 | 267 | 68.7.523.V45 | 268 |
| 5.44.095.80 | 166 | 5.44.122.00 | 195 | 67.1077 | 267 | 68.7.524.V45 | 269 |
| 5.44.096.80 | 167 | 5.44.123.00 | 195 | 67.1078 | 267 | 68.7.525.V45 | 269 |
| 5.44.097.80 | 167 | 5.44.124.00 | 168 | 67.1207 | 267 | 68.7.601.025 | 266 |
| 5.44.098.00 | 178 - 182 | 5.44.125.00 | 168 | 67.1227 | 267 | 68.7.750.035 | 270 |
| 5.44.098.20 | 168 - 178 | 5.44.126.00 | 223 | 67.2301 | 265 | 68.7.750.035 | 271 |
| 5.44.098.20 | 182 - 195 | 5.44.126.20 | 223 | 67.2302 | 265 | 68.7.792.025 | 271 |
| 5.44.098.70 | 178 - 182 | 5.44.127.00 | 223 | 67.2307 | 265 | 68.7.793.025 | 271 |
| 5.44.099.00 | 178 - 182 | 5.44.127.20 | 223 | 67.2309 | 265 | 68.7.796.025 | 270 |
| 5.44.100.20 | 180 - 181 | 5.44.128.00 | 223 | 67.2323 | 265 | 68.9.522.012 | 269 |
| 5.44.100.78 | 180 | 5.44.128.20 | 223 | 67.2328 | 265 | 68.9.522.V25 | 269 |
| 5.44.100.80 | 180 | 5.44.129.00 | 223 | 67.2329 | 265 | 68.9.523.012 | 268 |
| 5.44.101.20 | 180 - 181 | 5.44.129.20 | 223 | 67.2357 | 265 | 68.9.523.V25 | 268 |
| 5.44.101.80 | 180 | 5.44.130.00 | 192 - 193 | 67.2358 | 265 | 68.9.525.012 | 268 |
| 5.44.101.81 | 180 | 5.44.131.00 | 192 - 193 | 67.2367 | 265 | 68.9.526.012 | 268 |
| 5.44.102.78 | 181 | 5.44.132.00 | 192 - 193 | 67.2368 | 265 | 68.9.527.012 | 267 |
| 5.44.102.80 | 181 | 5.44.133.00 | 193 | 68.4.466.025 | 272 | 68.9.528.012 | 268 |
| 5.44.103.80 | 181 | 5.44.134.00 | 193 - 194 | 68.5.200.025 | 272 | 7.43.060.31 | 134 |
| 5.44.103.81 | 181 | 5.44.135.00 | 193 - 194 | 68.5.401.045 | 266 | 7.43.064.41 | 145 |
| 5.44.104.00 | 181 | 5.44.136.00 | 193 - 194 | 68.5.622.000 | 268 | 7.43.070.80 | 155 |
| 5.44.104.20 | 181 - 182 | 5.44.137.00 | 193 - 194 | 68.5.631.001 | 268 | 7.43.071.80 | 155 |
| 5.44.104.70 | 181 | 5.44.138.00 | 194 | 68.5.675.025 | 271 | 7.43.074.81 | 146 |

| CODICE/CODE | PAG. | CODICE/CODE | PAG. | CODICE/CODE | PAG. |
|-------------|-----------|-------------|------|--------------|------|
| 7.43.078.81 | 146 | 8.00.069.00 | 96 | 8.40.071.00 | 227 |
| 7.43.080.81 | 145 | 8.00.072.00 | 97 | 8.40.076.00 | 227 |
| 7.43.084.81 | 145 | 8.00.073.00 | 97 | 8.40.077.00 | 227 |
| 7.43.086.81 | 145 | 8.00.148.00 | 8 | 8.40.080.00 | 228 |
| 7.44.050.00 | 220 | 8.00.149.00 | 8 | 8.40.081.00 | 228 |
| 7.44.050.20 | 220 - 224 | 8.10.000.00 | 95 | 8.40.086.00 | 226 |
| 7.44.051.00 | 220 | 8.10.001.00 | 95 | 8.40.088.19 | 226 |
| 7.44.054.00 | 221 | 8.10.002.00 | 95 | 8.40.090.00 | 227 |
| 7.44.054.20 | 221 | 8.10.003.00 | 95 | 8.40.091.00 | 227 |
| 7.44.055.00 | 221 | 8.10.004.00 | 95 | 8.40.092.00 | 227 |
| 7.44.056.00 | 224 | 8.10.005.00 | 95 | 8.40.093.00 | 227 |
| 7.44.057.00 | 224 | 8.10.006.00 | 95 | 8.40.100.00 | 226 |
| 7.44.058.00 | 224 | 8.10.007.00 | 95 | 8.40.108.60 | 228 |
| 7.44.059.00 | 224 | 8.10.014.00 | 96 | 8.40.109.60 | 228 |
| 7.44.060.00 | 220 | 8.10.015.00 | 96 | 8.50.054.00 | 229 |
| 7.44.060.20 | 220 | 8.10.028.00 | 95 | 8.50.056.00 | 229 |
| 7.44.061.00 | 220 | 8.10.029.00 | 95 | 8.50.058.00 | 229 |
| 7.44.061.20 | 220 | 8.10.030.00 | 96 | 8.50.058.17 | 230 |
| 7.44.090.80 | 208 | 8.10.031.00 | 96 | 8.50.059.17 | 230 |
| 7.44.091.80 | 208 | 8.10.112.00 | 97 | 8.50.060.00 | 230 |
| 7.44.092.00 | 208 | 8.10.113.00 | 97 | 8.50.062.00 | 230 |
| 7.44.093.00 | 208 | 8.10.114.00 | 97 | 8.50.063.00 | 230 |
| 7.44.094.80 | 208 | 8.10.115.00 | 97 | 8.50.064.00 | 230 |
| 7.44.095.80 | 208 | 8.10.116.00 | 97 | 8.50.065.00 | 230 |
| 7.44.096.20 | 209 | 8.10.117.00 | 97 | 8.50.070.00 | 99 |
| 7.44.096.80 | 209 | 8.20.050.00 | 98 | 8.90.050.00 | 94 |
| 7.44.097.20 | 209 | 8.20.054.00 | 229 | 8.90.050.17 | 94 |
| 7.44.097.80 | 209 | 8.20.066.00 | 98 | 8.90.052.00 | 94 |
| 7.44.098.80 | 223 | 8.20.067.00 | 98 | 80.246.00 | 254 |
| 7.44.099.80 | 223 | 8.20.068.00 | 99 | B08.839.908D | 241 |
| 7.45.052.00 | 233 | 8.20.070.00 | 98 | B08.896.004 | 241 |
| 70.1000.20 | 270 | 8.20.072.00 | 99 | | |
| 70.1000.30 | 270 | 8.20.073.00 | 99 | | |
| 70.1001.20 | 270 | 8.20.074.00 | 98 | | |
| 70.1001.30 | 270 | 8.20.082.00 | 99 | | |
| 70.1018.40 | 265 | 8.20.094.00 | 98 | | |
| 70.1018.60 | 265 | 8.20.096.00 | 99 | | |
| 70.1019.40 | 265 | 8.20.097.00 | 99 | | |
| 70.1019.60 | 265 | 8.20.098.00 | 98 | | |
| 70.1032.90 | 270 | 8.20.099.00 | 98 | | |
| 780.106.00 | 254 | 8.20.100.00 | 229 | | |
| 780.108.00 | 254 | 8.40.042.00 | 227 | | |
| 780.502 | 254 | 8.40.043.00 | 227 | | |
| 8.00.056.00 | 94 | 8.40.060.00 | 226 | | |
| 8.00.057.00 | 94 | 8.40.061.00 | 226 | | |
| 8.00.064.00 | 94 | 8.40.066.00 | 226 | | |
| 8.00.065.00 | 94 | 8.40.067.00 | 226 | | |
| 8.00.068.00 | 96 | 8.40.070.00 | 227 | | |

ORIGINAL PARTS NUMBERS
RIFERIMENTI ORIGINALI

RIFERIMENTI ORIGINALI ORIGINAL PARTS NUMBERS
AVVERTENZE PER LA CONSULTAZIONE

i riferimenti originali riportati nelle tabelle seguenti, sono forniti a mero titolo informativo ed il loro utilizzo nel presente catalogo ha l'unico scopo di aiutare e agevolare la corretta identificazione del modello di veicolo sul quale deve montarsi il pezzo di ricambio.

Si avverte, ad ogni fine, che la scelta dei prodotti deve essere determinata ed avvenire unicamente in base ai codici Olsa parts riportati nelle parti illustrative del catalogo.

NOTES FOR CONSULTATION

the original references which are reported in the following tables are provided for information purposes only and their use in this catalogue must be intended only and just to help and facilitate the correct identification of the vehicle model on which the spare parts must be fitted to.

In any event, we warn that the choice of products must be determined only by and according to Olsa parts references contained in the illustrated sections of this catalogue.

| ALFA ROMEO | OLSA Parts |
|------------|-------------|
| 4747611 | 2.45.053.00 |
| 4747613 | 2.45.052.00 |
| 46408006 | 1.05.054.00 |
| 46546918 | 1.06.076.00 |
| 46546919 | 1.06.077.00 |
| 46556563 | 1.02.052.00 |
| 46776234 | 1.06.052.00 |
| 46778631 | 1.06.053.00 |
| 46786572 | 1.05.052.00 |
| 50504339 | 1.06.078.00 |
| 50504340 | 1.06.079.00 |
| 50508590 | 8.00.056.00 |
| 50508592 | 8.00.057.00 |
| 50513400 | 5.04.192.00 |
| 50513401 | 5.04.193.00 |
| 50513612 | 5.04.190.00 |
| 50513613 | 5.04.191.00 |
| 50513758 | 1.02.161.00 |
| 50513781 | 8.20.074.00 |
| 50522970 | 1.04.144.00 |
| 50522993 | 1.02.160.00 |
| 50550396 | 1.05.080.80 |
| 51925086 | 1.04.144.00 |
| 60582887 | 2.01.106.12 |
| 60582888 | 2.01.107.12 |
| 60597299 | 1.02.126.00 |
| 60597300 | 1.02.127.00 |
| 60620141 | 1.02.056.00 |

| 60620142 | 1.02.057.00 |
|-------------|-------------|
| 60620256 | 1.06.081.00 |
| 60620257 | 1.06.080.00 |
| 60686516 | 1.02.054.12 |
| 60686517 | 1.02.055.12 |
| 60691105 | 1.02.125.00 |
| 60691106 | 1.02.124.00 |
| 60692719 | 8.20.050.00 |
| 60694592 | 1.02.060.00 |
| 517134000 | 1.05.104.00 |
| AUDI | OLSA Parts |
| 4G8945093H | 1.04.203.00 |
| 4G8945094H | 1.04.202.00 |
| 4G8945095H | 1.04.205.00 |
| 4G8945096H | 1.04.204.00 |
| 81A949101 | 5.02.106.80 |
| 81A949102 | 5.02.107.80 |
| 8L0953049 | 2.01.125.00 |
| 8L0953050 | 2.01.124.00 |
| 8S0945095 | 1.04.206.00 |
| 8S0945096 | 1.04.207.00 |
| 8U0945093H | 1.04.146.00 |
| 8U0945094H | 1.04.147.00 |
| BMW | OLSA Parts |
| 63137171007 | 1.02.183.00 |
| 63137171008 | 1.02.182.00 |
| 63137303243 | 1.02.187.00 |
| 63137303244 | 1.02.186.00 |
| 63147187087 | 1.02.189.00 |

| | |
|-------------|-------------|
| 63147187088 | 1.02.188.00 |
| 63212760685 | 1.04.241.00 |
| 63212760686 | 1.04.240.00 |
| 63212760687 | 1.04.239.00 |
| 63212760688 | 1.04.238.00 |
| 63212990109 | 1.04.135.00 |
| 63212990110 | 1.04.134.00 |
| 63212990113 | 1.04.139.00 |
| 63212990114 | 1.04.138.00 |
| 63212992477 | 1.04.137.00 |
| 63212992478 | 1.04.136.00 |
| 63212992479 | 1.04.141.00 |
| 63212992480 | 1.04.140.00 |
| 63217311029 | 1.04.249.00 |
| 63217311030 | 1.04.248.00 |
| 63217311031 | 1.04.253.00 |
| 63217311032 | 1.04.252.00 |
| 63217311041 | 1.04.251.00 |
| 63217311042 | 1.04.250.00 |
| 63217311059 | 1.04.247.00 |
| 63217311060 | 1.04.246.00 |
| 63217329791 | 1.04.337.00 |
| 63217329792 | 1.04.336.00 |
| 63217330473 | 1.04.335.00 |
| 63217330474 | 1.04.334.00 |
| 63217350695 | 1.04.241.00 |
| 63217350696 | 1.04.240.00 |
| 63217350697 | 1.04.239.00 |
| 63217350698 | 1.04.238.00 |

| | |
|----------------|--------------------------|
| 63217350711 | 1.04.243.00 |
| 63217350712 | 1.04.242.00 |
| 63217350715 | 1.04.245.00 |
| 63217350716 | 1.04.244.00 |
| 63217359017 | 1.04.255.00 |
| 63217359018 | 1.04.254.00 |
| 63217359019 | 1.04.257.00 |
| 63217359020 | 1.04.256.00 |
| 63217420737 | 1.04.307.80 |
| 63217420738 | 1.04.306.80 |
| 63217420739 | 1.04.301.80 |
| 63217420740 | 1.04.300.80 |
| 63217420747 | 1.04.305.80 |
| 63217420748 | 1.04.304.80 |
| 63217461473 | 1.04.249.00 |
| 63217461474 | 1.04.248.00 |
| 63217461477 | 1.04.253.00 |
| 63217461478 | 1.04.252.00 |
| 63217461607 | 1.04.323.00 |
| 63217461608 | 1.04.322.00 |
| 63217461609 | 1.04.325.00 |
| 63217461610 | 1.04.324.00 |
| 63217465509 | 1.04.303.80 |
| 63217465510 | 1.04.302.80 |
| 63217477713 | 1.04.331.80 |
| 63217477714 | 1.04.330.80 |
| 63217477715 | 1.04.331.16 |
| 63217477716 | 1.04.330.16 |
| 63217477717 | 1.04.333.80 |
| 63217477718 | 1.04.332.80 |
| 63217477721 | 1.04.333.16 |
| 63217477722 | 1.04.332.16 |
| 63217488541 | 1.04.243.00 |
| 63217488545 | 1.04.245.00 |
| 63217488546 | 1.04.244.00 |
| 63269481841 | 1.05.128.80 |
| CITROËN | OLSA <i>Parts</i> |
| 62060 | 8.50.070.00 |
| 632567 | 2.02.180.12 |
| 632567 | 2.02.180.12 |
| 9687551580 | 1.06.087.00 |

| | |
|--------------|--------------------------|
| 9687551680 | 1.06.086.00 |
| 6340E9 | 1.05.124.00 |
| 6206S7 | 2020001105 |
| 6206S9 | 2020001107 |
| 6208S7 | 2020101105 |
| 6208S9 | 2020101107 |
| 6340G7 | 1.05.126.00 |
| 6350FH | 5.04.181.00 |
| 6350T7 | 2024001003 |
| 6351FJ | 5.04.180.00 |
| 6351T7 | 2024101003 |
| DACIA | OLSA <i>Parts</i> |
| 265500033R | 2.04.086.10 |
| 265500284R | 2.04.118.10 |
| 265550035R | 2.04.087.10 |
| 265556730R | 2.04.119.10 |
| DAF | OLSA <i>Parts</i> |
| 1378137 | 2.43.048.00 |
| 1378137 | 2.43.048.00 |
| 1451482 | 2.44.066.20 |
| 1625985 | 2.44.121.00 |
| 1625986 | 2.44.120.00 |
| 1626101 | 2.41.116.20 |
| 1725410 | 2.43.260.80 |
| 1735355 | 2.41.114.12 |
| 1735355 | 2.42.134.00 |
| 1846491 | 2.42.145.00 |
| 1846492 | 2.42.144.00 |
| 1875576 | 5.44.090.00 |
| 1875577 | 5.44.091.01 |
| 1875578 | 5.44.090.70 |
| 1875579 | 5.44.092.00 |
| 1875580 | 5.44.093.01 |
| 1875581 | 5.44.092.70 |
| 1914690 | 5.44.091.20 |
| 1914690 | 5.44.091.20 |
| 1914691 | 5.44.090.20 |
| 1914691 | 5.44.090.20 |
| 1945483 | 2.43.260.80 |
| 1981861 | 2.44.332.80 |
| 1981862 | 2.44.333.81 |

| | |
|----------------|--------------------------|
| EVOBUS | OLSA <i>Parts</i> |
| A0005446911 | 2.43.052.80 |
| A6138260241 | 2.43.048.00 |
| A6138260241 | 2.43.048.00 |
| FERRARI | OLSA <i>Parts</i> |
| 246571 | 1.04.318.80 |
| 326816 | 1.04.320.80 |
| 343194 | 1.04.316.00 |
| 81900700 | 1.04.314.00 |
| 81900800 | 1.04.315.00 |
| 84806800 | 1.06.094.00 |
| 84806900 | 1.06.095.00 |
| 87329500 | 1.02.193.00 |
| 87329600 | 1.02.192.00 |
| 87329700 | 1.02.190.00 |
| 87329800 | 1.02.191.00 |
| FIAT | OLSA <i>Parts</i> |
| 4053995 | 1.02.098.00 |
| 4126068 | 1.01.050.00 |
| 4141619 | 5.06.050.00 |
| 4304311 | 1.02.088.00 |
| 4477544 | 1.42.050.00 |
| 4758185 | 2.45.050.00 |
| 4758186 | 2.45.051.00 |
| 5938446 | 1.05.056.00 |
| 5942654 | 2.01.085.00 |
| 5942654 | 2.01.085.24 |
| 5958536 | 2.01.084.00 |
| 5958536 | 2.01.084.24 |
| 7538306 | 2.01.086.00 |
| 7538306 | 2.01.086.25 |
| 7538307 | 2.01.087.00 |
| 7538307 | 2.01.087.25 |
| 7567804 | 2.44.110.00 |
| 7567805 | 2.44.111.00 |
| 7570793 | 1.04.063.00 |
| 7570892 | 1.04.062.00 |
| 7572825 | 1.04.062.10 |
| 7572826 | 1.04.063.10 |
| 7576767 | 1.02.090.00 |
| 7595373 | 1.02.074.00 |

| | | | | | |
|----------|-------------|----------|-------------|----------|-------------|
| 7626742 | 1.02.066.00 | 46758989 | 5.04.057.00 | 51810675 | 1.05.120.00 |
| 7626742 | 1.02.066.11 | 46758991 | 1.04.090.00 | 51810677 | 1.06.092.00 |
| 7642681 | 8.10.014.00 | 46769166 | 2.01.054.00 | 51810678 | 1.06.093.00 |
| 7642682 | 8.10.015.00 | 46769168 | 2.01.055.00 | 51820270 | 8.20.098.00 |
| 7657557 | 1.05.064.00 | 46808225 | 1.04.082.00 | 51820271 | 8.20.099.00 |
| 7698773 | 2.44.056.00 | 46814089 | 1.05.074.00 | 51821699 | 1.04.216.00 |
| 7698774 | 2.44.057.00 | 46823705 | 5.04.068.00 | 51822766 | 1.02.058.12 |
| 7700538 | 1.42.052.00 | 46823706 | 5.04.069.00 | 51822766 | 1.02.058.12 |
| 7732499 | 1.02.092.00 | 46834769 | 1.06.066.00 | 51823092 | 1.02.146.12 |
| 7767732 | 1.05.062.00 | 46834769 | 1.06.074.00 | 51830564 | 2.04.074.10 |
| 7767732 | 1.05.096.00 | 46834771 | 1.06.067.00 | 51830565 | 2.04.075.10 |
| 7779100 | 1.06.058.00 | 46834771 | 1.06.075.00 | 51842914 | 2.01.144.10 |
| 7779101 | 1.06.059.00 | 51701589 | 5.04.085.00 | 51842914 | 8.00.148.00 |
| 46305952 | 1.02.076.00 | 51701590 | 5.04.084.00 | 51842915 | 2.01.145.10 |
| 46402655 | 2.01.052.00 | 51701593 | 8.00.065.00 | 51842915 | 8.00.149.00 |
| 46402656 | 2.01.053.00 | 51701594 | 8.00.064.00 | 51843642 | 5.04.216.00 |
| 46402657 | 2.01.050.00 | 51717075 | 8.10.028.00 | 51843643 | 5.04.217.00 |
| 46402658 | 2.01.051.00 | 51717076 | 8.10.029.00 | 51848137 | 1.04.064.00 |
| 46411406 | 2.01.090.00 | 51717793 | 1.02.080.12 | 51848138 | 1.04.065.00 |
| 46411407 | 2.01.091.00 | 51718011 | 5.04.086.00 | 51849738 | 5.04.183.00 |
| 46421728 | 8.10.000.00 | 51718011 | 5.04.086.00 | 51849739 | 5.04.182.00 |
| 46421729 | 8.10.001.00 | 51718011 | 5.04.086.00 | 51854689 | 5.04.200.00 |
| 46421732 | 8.10.004.00 | 51718012 | 5.04.087.00 | 51854691 | 5.04.201.00 |
| 46421733 | 8.10.005.00 | 51718012 | 5.04.087.00 | 51854694 | 1.04.112.00 |
| 46421734 | 8.10.002.00 | 51718012 | 5.04.087.00 | 51854698 | 1.04.113.00 |
| 46421735 | 8.10.003.00 | 51718120 | 1.06.068.00 | 51855638 | 8.00.068.00 |
| 46421736 | 8.10.006.00 | 51718121 | 1.06.069.00 | 51855644 | 8.00.069.00 |
| 46421737 | 8.10.007.00 | 51746492 | 1.02.134.12 | 51858822 | 1.01.052.00 |
| 46425296 | 1.06.064.00 | 51746913 | 8.20.070.00 | 51858823 | 1.01.053.00 |
| 46425297 | 1.06.065.00 | 51755144 | 2.04.050.10 | 51858824 | 8.20.082.00 |
| 46426713 | 1.02.082.00 | 51755144 | 5.04.070.00 | 51858824 | 8.20.094.00 |
| 46450200 | 1.02.068.00 | 51755145 | 2.04.051.10 | 51867675 | 8.10.030.00 |
| 46511353 | 2.01.058.00 | 51755145 | 5.04.071.00 | 51867677 | 8.10.031.00 |
| 46511355 | 2.01.059.00 | 51770192 | 1.05.106.00 | 51883571 | 1.04.142.00 |
| 46511360 | 1.02.078.00 | 51782979 | 8.20.070.00 | 51883572 | 1.04.143.00 |
| 46511360 | 1.02.094.00 | 51787493 | 5.04.102.00 | 51883585 | 1.05.092.00 |
| 46522717 | 1.02.096.12 | 51787494 | 5.04.103.00 | 51883587 | 5.04.112.00 |
| 46532400 | 1.05.084.00 | 51810673 | 2.04.076.10 | 51883589 | 5.04.113.00 |
| 46738734 | 5.04.052.00 | 51810673 | 5.04.196.00 | 51898184 | 8.20.098.00 |
| 46738735 | 5.04.053.00 | 51810674 | 2.04.077.10 | 51898185 | 8.20.099.00 |
| 46758986 | 5.04.056.00 | 51810674 | 5.04.197.00 | 51909639 | 5.04.182.19 |

| | |
|----------|-------------|
| 51909648 | 5.04.183.19 |
| 51918104 | 1.04.152.00 |
| 51918105 | 1.04.153.00 |
| 51922307 | 1.04.142.16 |
| 51922308 | 1.04.143.16 |
| 51937403 | 1.04.191.06 |
| 51937405 | 1.01.054.00 |
| 51937408 | 1.01.055.00 |
| 51937411 | 1.04.186.00 |
| 51937413 | 1.04.190.06 |
| 51937414 | 1.04.187.00 |
| 51941875 | 1.06.088.00 |
| 51941876 | 1.06.089.00 |
| 51945058 | 1.04.150.00 |
| 51945059 | 1.04.151.00 |
| 51959332 | 5.04.112.00 |
| 51959334 | 5.04.113.00 |
| 51974247 | 2.04.104.10 |
| 51974248 | 2.04.105.10 |
| 51974249 | 2.04.116.10 |
| 51974250 | 2.04.117.10 |
| 51984457 | 5.04.257.00 |
| 51984459 | 2.04.115.10 |
| 51984459 | 5.04.255.00 |
| 51984460 | 5.04.256.00 |
| 51984487 | 2.04.114.10 |
| 51984487 | 5.04.254.00 |
| 52007422 | 5.04.258.00 |
| 52007424 | 5.04.259.00 |
| 52008634 | 1.04.198.00 |
| 52008634 | 1.04.198.00 |
| 52008635 | 1.04.199.00 |
| 52008635 | 1.04.199.00 |
| 52015535 | 8.20.068.00 |
| 52015961 | 1.04.208.00 |
| 52015963 | 1.04.209.00 |
| 52015967 | 1.04.212.00 |
| 52015968 | 1.04.213.00 |
| 52022739 | 1.04.188.00 |
| 52022742 | 1.04.189.00 |
| 52044716 | 2.04.116.10 |

| | |
|-----------|-------------|
| 52044718 | 2.04.117.10 |
| 52071021 | 1.04.210.00 |
| 52071022 | 1.04.211.00 |
| 52078932 | 1.04.208.00 |
| 52078933 | 1.04.209.00 |
| 52092111 | 1.04.296.00 |
| 52092112 | 1.04.296.16 |
| 52092113 | 1.04.296.06 |
| 52092842 | 1.04.297.00 |
| 52092843 | 1.04.297.16 |
| 52092844 | 1.04.297.06 |
| 52092846 | 1.01.056.00 |
| 52092847 | 1.01.057.00 |
| 52093917 | 1.04.279.00 |
| 52093918 | 1.04.280.00 |
| 52093919 | 1.04.281.00 |
| 52115342 | 1.04.278.00 |
| 52115343 | 1.04.279.00 |
| 52157298 | 1.04.326.80 |
| 52157300 | 1.04.329.80 |
| 52157302 | 1.04.328.80 |
| 52157304 | 1.04.327.80 |
| 52162675 | 1.04.278.00 |
| 52162676 | 1.04.279.00 |
| 60694592 | 1.02.070.00 |
| 71713033 | 1.45.054.00 |
| 71716699 | 70.1018.60 |
| 71716700 | 70.1019.60 |
| 71716701 | 70.1018.40 |
| 71716702 | 70.1019.40 |
| 71748244 | 67.0657 |
| 71748245 | 67.0658 |
| 71748252 | 5.42.056.12 |
| 71748253 | 5.42.057.12 |
| 71748254 | 5.42.058.12 |
| 71748255 | 5.42.059.12 |
| 77363282 | 1.04.060.18 |
| 77363283 | 1.04.061.18 |
| 77363999 | 1.04.060.10 |
| 77364000 | 1.04.061.10 |
| 132635808 | 2.44.056.10 |

| | |
|------------|-------------|
| 132635908 | 2.44.057.10 |
| 469299999 | 8.20.054.00 |
| 469309999 | 8.20.054.00 |
| 735318908 | 1.44.096.00 |
| 735354549 | 1.08.056.00 |
| 735413383 | 1.08.052.00 |
| 735430904 | 1.45.068.00 |
| 735480886 | 67.2358 |
| 735480889 | 67.2368 |
| 735480890 | 67.2328 |
| 735480933 | 67.2357 |
| 735480934 | 67.2309 |
| 735480936 | 67.2367 |
| 735480940 | 67.2323 |
| 735480943 | 67.2329 |
| 735480944 | 67.2307 |
| 735517038 | 67.2302 |
| 735517070 | 67.2301 |
| 735645071 | 67.1032.01 |
| 735645080 | 67.1033.01 |
| 735671212 | 1.04.152.90 |
| 735671213 | 1.04.298.16 |
| 735671214 | 1.04.153.90 |
| 735671215 | 1.04.299.16 |
| 1301076080 | 1.42.054.00 |
| 1302999080 | 2.44.056.00 |
| 1303000080 | 2.44.057.00 |
| 1303499808 | 1.45.064.00 |
| 1303845080 | 1.45.054.00 |
| 1303853080 | 2.41.108.12 |
| 1303854080 | 2.41.109.12 |
| 1317573080 | 1.46.052.00 |
| 1328427080 | 2.44.058.10 |
| 1328428080 | 2.44.059.10 |
| 1332946080 | 1.42.058.11 |
| 1344047080 | 2.44.206.10 |
| 1344047080 | 5.44.068.00 |
| 1344050080 | 2.44.207.10 |
| 1344050080 | 5.44.069.00 |
| 1353214080 | 1.04.214.00 |
| 1356780080 | 8.20.066.00 |

| | |
|-------------|--------------------------|
| 1357925080 | 8.20.067.00 |
| 1360259080 | 2.44.056.00 |
| 1362912080 | 1.05.118.00 |
| 1367061080 | 8.40.088.19 |
| 1370206080 | 5.44.068.19 |
| 1370207080 | 5.44.069.19 |
| 1372698080 | 5.44.124.00 |
| 1372699080 | 5.44.125.00 |
| 1380672080 | 2.44.273.10 |
| 1380672080 | 5.44.088.00 |
| 1380673080 | 2.44.272.10 |
| 1380673080 | 5.44.089.00 |
| 6000617811 | 2.44.294.10 |
| 6000617812 | 2.44.295.10 |
| 6000620190 | 1.44.106.00 |
| 6000620192 | 1.44.107.00 |
| 9406303537 | 5.41.068.00 |
| 9406303547 | 5.41.069.00 |
| 9467069888 | 2.04.103.10 |
| 9467069888 | 5.04.154.00 |
| 9467069988 | 2.04.102.10 |
| 9467069988 | 5.04.155.00 |
| 9645268380 | 1.45.062.00 |
| 9680057480 | 1.02.148.00 |
| 9790384780 | 2.04.059.10 |
| 9790384880 | 2.04.058.10 |
| 13034976670 | 1.48.058.00 |
| FORD | OLSA <i>Parts</i> |
| 1063835 | 2.02.182.11 |
| 1065645 | 2.02.182.11 |
| 1113574 | 2.44.050.10 |
| 1113577 | 2.44.051.10 |
| 1116629 | 2.44.050.10 |
| 1116630 | 2.44.051.10 |
| 1205546 | 5.42.054.00 |
| 1205547 | 5.42.055.00 |
| 1369220 | 2.44.055.10 |
| 1369221 | 2.44.054.10 |
| 1405019 | 5.02.054.12 |
| 1405020 | 5.02.055.12 |
| 1408388 | 2.44.052.10 |

| | |
|----------------|-------------|
| 1425136 | 5.02.050.12 |
| 1425141 | 5.02.051.12 |
| 1435880 | 2.44.052.10 |
| 1435881 | 2.44.053.10 |
| 1562338 | 8.20.073.00 |
| 1562465 | 8.20.072.00 |
| 1719704 | 2021001119 |
| 1719709 | 2021101119 |
| 1846222 | 2.44.316.00 |
| 1846223 | 2.44.317.00 |
| 1847493 | 2.44.278.10 |
| 1847494 | 2.44.279.10 |
| 1855334 | 2.44.267.10 |
| 1855335 | 2.44.266.10 |
| 1870425 | 2.44.266.10 |
| 1870426 | 2.44.267.10 |
| 1908967 | 2.44.314.10 |
| 1908969 | 2.44.315.10 |
| 1940132 | 2.44.278.00 |
| 4060340 | 2.44.053.10 |
| 4355478 | 2.02.182.12 |
| 5098937 | 2.44.165.00 |
| 5098938 | 2.44.164.00 |
| 5177810 | 2.44.165.00 |
| 5177813 | 2.44.164.00 |
| 6777877 | 2.01.072.00 |
| 6777878 | 2.01.073.00 |
| 14309E | 2.44.279.00 |
| 14310E | 2.44.278.00 |
| 2T1413A602AF | 2.44.054.10 |
| 2T1413A603AF | 2.44.055.10 |
| 4M51-13A602-CB | 2021001025 |
| 4M51-13A603-CB | 2021101025 |
| 6N11-13A602-AB | 2021001031 |
| 6N11-13A603-AB | 2021101031 |
| 7S71-13005-AH | 2020001067 |
| 7S71-13006-AH | 2020101067 |
| 7S71-13100-AF | 2020001069 |
| 7S71-13101-AF | 2020101069 |
| 7S71-13A602-NF | 2021001052 |
| 7S71-13A602-PF | 2021001050 |

| | |
|----------------|--------------------------|
| 7S71-13A603-NF | 2021101052 |
| 7S71-13A603-PF | 2021101050 |
| 8M51-13404-LC | 2021001102 |
| 8M51-13404-NB | 2021001104 |
| 8M51-13405-LC | 2021101102 |
| 8M51-13405-NB | 2021101104 |
| 95VG13405 | 2.44.049.00 |
| 9EL354679011 | 2021101105 |
| 9EL354679021 | 2021001105 |
| 9T1613404AA | 2.44.164.00 |
| 9T16-13404-AA | 2.44.165.00 |
| 9T1613405AA | 2.44.165.00 |
| 9T16-13405-AA | 2.44.164.00 |
| BK-31-13404AF | 2.44.266.10 |
| BK3113404AG | 2.44.266.10 |
| BK-31-13405AF | 2.44.267.10 |
| BK3113405AG | 2.44.267.10 |
| IRIBUS | OLSA <i>Parts</i> |
| 99441270 | 2.44.168.00 |
| 99441271 | 2.44.167.00 |
| 99441272 | 2.44.170.00 |
| 99441273 | 2.41.076.00 |
| 99441274 | 2.44.171.00 |
| 150324200 | 2.44.169.00 |
| IVECO | OLSA <i>Parts</i> |
| 1329718 | 2.42.076.00 |
| 1329718 | 2.42.076.00 |
| 1904639 | 1.44.050.00 |
| 1904639 | 1.44.050.00 |
| 1904639 | 2.44.228.00 |
| 1904640 | 1.44.051.00 |
| 1904640 | 1.44.051.00 |
| 1904640 | 2.44.229.00 |
| 2996671 | 68.6.622.000 |
| 2997216 | 68.5.631.001 |
| 2997667 | 68.7.524.V45 |
| 2997668 | 68.7.525.V45 |
| 3801914 | 2.42.061.12 |
| 3801915 | 2.42.060.12 |
| 3801926 | 68.7.417.V45Q |
| 3801928 | 68.7.418.V45Q |

| | |
|----------|--------------|
| 4347159 | 1.42.060.00 |
| 4707925 | 1.43.058.00 |
| 4728621 | 2.42.102.00 |
| 4728622 | 2.42.102.00 |
| 4747951 | 1.41.053.00 |
| 4747953 | 1.41.052.00 |
| 4765922 | 8.40.092.00 |
| 4766018 | 8.40.093.00 |
| 4809446 | 1.44.053.00 |
| 4809448 | 1.44.052.00 |
| 4809449 | 1.44.055.01 |
| 4814863 | 8.40.100.00 |
| 4817100 | 8.40.071.00 |
| 4817101 | 8.40.070.00 |
| 4825503 | 1.45.050.00 |
| 4859828 | 1.43.054.00 |
| 7980141 | 1.41.052.24 |
| 7980142 | 1.41.053.24 |
| 7984015 | 1.44.050.20 |
| 7984016 | 1.44.051.20 |
| 8120298 | 2.41.059.27 |
| 8143122 | 68.9.523.V25 |
| 8194504 | 2.41.127.25 |
| 8194505 | 2.41.126.25 |
| 8963026 | 8.40.086.00 |
| 8963976 | 2.41.058.27 |
| 41200664 | 5.42.070.00 |
| 41221015 | 8.40.042.00 |
| 41221029 | 2.42.081.00 |
| 41221036 | 8.40.043.00 |
| 41221039 | 2.42.080.00 |
| 41221040 | 2.41.066.00 |
| 41221041 | 2.41.067.00 |
| 42056537 | 2.44.134.00 |
| 42304485 | 2.44.128.00 |
| 42304486 | 2.44.130.00 |
| 42304487 | 2.44.132.00 |
| 42342171 | 2.42.050.00 |
| 42471137 | 1.44.058.20 |
| 42471138 | 1.44.059.20 |
| 42531562 | 1.44.052.20 |

| | |
|----------|--------------|
| 42531584 | 1.44.064.21 |
| 42531584 | 1.44.070.22 |
| 42534678 | 1.42.076.11 |
| 42534679 | 1.42.077.11 |
| 42555022 | 2.41.066.00 |
| 42555023 | 2.41.067.00 |
| 42555041 | 2.41.050.00 |
| 42555042 | 2.41.051.00 |
| 42555131 | 2.44.064.20 |
| 42555132 | 2.44.065.20 |
| 42566495 | 2.44.066.20 |
| 42566495 | 5.44.098.20 |
| 46743133 | 1.44.098.00 |
| 69500010 | 8.40.060.00 |
| 69500013 | 8.40.061.00 |
| 69500026 | 2.44.064.00 |
| 69500032 | 2.44.065.00 |
| 69500590 | 2.44.072.10 |
| 69500591 | 2.44.073.10 |
| 93158535 | 1.44.051.20 |
| 93158535 | 2.44.229.20 |
| 93158536 | 1.44.050.20 |
| 93158536 | 2.44.228.20 |
| 93160422 | 1.44.053.20 |
| 93161844 | 1.44.064.21 |
| 93161844 | 2.44.174.20 |
| 93190974 | 68.9.527.012 |
| 93190977 | 68.9.528.012 |
| 93190982 | 68.7.517.020 |
| 93191716 | 2.44.128.21 |
| 93193203 | 68.9.526.012 |
| 98409216 | 68.9.522.V25 |
| 98418078 | 1.43.054.00 |
| 98418080 | 1.43.056.00 |
| 98421202 | 1.44.056.00 |
| 98421202 | 1.44.056.00 |
| 98421203 | 1.44.057.00 |
| 98421203 | 1.44.057.00 |
| 98426074 | 2.45.053.00 |
| 98426076 | 2.45.052.00 |
| 98428489 | 1.44.061.00 |

| | |
|-----------|--------------|
| 98428491 | 1.44.060.00 |
| 98428493 | 1.44.063.01 |
| 98433912 | 2.41.048.00 |
| 98433913 | 2.41.049.00 |
| 98435942 | 1.44.050.00 |
| 98435942 | 1.44.050.00 |
| 98435944 | 1.44.051.00 |
| 98435944 | 1.44.051.00 |
| 98443250 | 2.43.326.00 |
| 98443252 | 2.43.327.00 |
| 98449181 | 5.41.050.00 |
| 98449182 | 5.41.051.00 |
| 98449391 | 1.45.050.00 |
| 98460036 | 5.41.054.00 |
| 98460038 | 5.41.055.00 |
| 98461648 | 2.43.327.00 |
| 98461649 | 2.43.326.00 |
| 98473007 | 68.9.522.V25 |
| 98473011 | 68.9.523.V25 |
| 99441287 | 2.43.112.00 |
| 99441288 | 2.43.048.00 |
| 99441288 | 2.43.048.00 |
| 99441302 | 2.43.114.00 |
| 99441739 | 1.43.053.00 |
| 99441740 | 1.43.052.00 |
| 99452662 | 1.42.072.00 |
| 99463242 | 1.44.064.00 |
| 99463242 | 2.44.138.00 |
| 99463243 | 1.44.065.00 |
| 99463244 | 1.44.067.01 |
| 99463244 | 2.44.139.01 |
| 500036581 | 2.43.094.80 |
| 500036582 | 2.43.050.00 |
| 500036583 | 2.43.051.00 |
| 500307754 | 8.40.066.00 |
| 500307755 | 8.40.067.00 |
| 500308514 | 5.42.050.00 |
| 500314716 | 2.43.329.00 |
| 500314717 | 2.43.328.00 |
| 500316960 | 1.43.051.00 |
| 500316961 | 1.43.050.00 |

| | |
|-----------|-------------|
| 500319555 | 2.44.060.00 |
| 500319555 | 2.44.060.10 |
| 500319556 | 2.44.061.00 |
| 500319556 | 2.44.061.10 |
| 500319558 | 2.44.060.00 |
| 500319558 | 2.44.060.10 |
| 500319559 | 2.44.061.00 |
| 500319559 | 2.44.061.10 |
| 500320425 | 5.41.072.00 |
| 500320426 | 5.41.073.00 |
| 500325706 | 67.1067 |
| 500325707 | 67.1068 |
| 500325710 | 67.1073 |
| 500325711 | 67.1074 |
| 500325712 | 67.1207 |
| 500325725 | 67.1069 |
| 500325726 | 67.1070 |
| 500325729 | 67.1075 |
| 500325730 | 67.1076 |
| 500325747 | 67.1077 |
| 500325748 | 67.1078 |
| 500325751 | 67.1227 |
| 500325883 | 1.45.066.00 |
| 500328136 | 1.42.062.00 |
| 500328137 | 1.42.063.00 |
| 500340695 | 2.41.100.00 |
| 500340696 | 2.41.101.00 |
| 500355252 | 1.42.066.00 |
| 500355253 | 1.42.067.00 |
| 500356782 | 1.44.058.00 |
| 500356783 | 1.44.059.00 |
| 500367925 | 2.42.104.00 |
| 500368110 | 1.42.076.00 |
| 500368111 | 1.42.077.00 |
| 500368112 | 1.42.076.00 |
| 500368113 | 1.42.077.00 |
| 500376180 | 1.43.064.00 |
| 500382616 | 1.44.056.00 |
| 500382616 | 1.44.056.00 |
| 500382617 | 1.44.057.00 |
| 500382617 | 1.44.057.00 |

| | |
|------------|--------------|
| 500382651 | 1.44.056.00 |
| 500382651 | 1.44.056.00 |
| 500382653 | 1.44.057.00 |
| 500382653 | 1.44.057.00 |
| 504032145 | 8.50.054.00 |
| 504032148 | 8.50.056.00 |
| 504045133 | 1.43.071.00 |
| 504047264 | 1.43.069.00 |
| 504047265 | 1.43.068.00 |
| 504047573 | 2.41.054.00 |
| 504055623 | 1.43.070.00 |
| 504063008 | 1.43.079.00 |
| 504063575 | 1.43.078.00 |
| 504074031 | 1.43.076.00 |
| 504074032 | 1.43.077.00 |
| 504098243 | 2.42.090.00 |
| 504098245 | 2.42.091.00 |
| 504104465 | 5.41.071.00 |
| 504104467 | 5.41.070.00 |
| 504104575 | 1.42.065.00 |
| 504104577 | 1.42.064.00 |
| 504104580 | 1.42.068.00 |
| 504104582 | 1.42.069.00 |
| 504158974 | 70.1001.20 |
| 504158975 | 70.1000.20 |
| 504158976 | 70.1001.30 |
| 504158977 | 70.1000.30 |
| 504168236 | 67.0103 |
| 504168244 | 70.1032.90 |
| 504181095 | 8.50.058.00 |
| 504181096 | 8.50.060.00 |
| 504188129 | 8.50.058.17 |
| 504188130 | 8.50.059.17 |
| 504197878 | 68.7.524.V45 |
| 504197879 | 68.7.525.V45 |
| 504224428 | 67.0107 |
| 504250958 | 2.42.085.00 |
| 504250984 | 2.42.084.00 |
| 3738200756 | 1.43.060.00 |
| 5001021041 | 2.43.048.00 |
| 5001021041 | 2.43.048.00 |

| | |
|------------|-------------|
| 5001862030 | 2.42.078.00 |
| 5801351218 | 2.44.065.00 |
| 5801363428 | 1.44.101.00 |
| 5801363430 | 1.44.103.01 |
| 5801363431 | 1.44.100.00 |
| 5801363432 | 1.44.102.70 |
| 5801375415 | 8.40.090.00 |
| 5801375416 | 8.40.091.00 |
| 5801426889 | 5.44.099.00 |
| 5801426894 | 5.44.098.00 |
| 5801426917 | 5.44.098.70 |
| 5801523220 | 5.44.081.00 |
| 5801523221 | 5.44.080.00 |
| 5801546522 | 1.43.080.80 |
| 5801546548 | 1.43.081.80 |
| 5801557592 | 5.44.084.00 |
| 5801557593 | 5.44.086.00 |
| 5801572018 | 2.41.094.00 |
| 5801572024 | 2.41.095.00 |
| 5801572074 | 2.42.087.00 |
| 5801572080 | 2.42.086.00 |
| 5801585146 | 5.41.087.00 |
| 5801585151 | 5.41.086.00 |
| 5801587021 | 8.20.100.00 |
| 5801610735 | 5.43.062.00 |
| 5801610737 | 5.43.063.00 |
| 5801631433 | 2.44.064.00 |
| 5801637182 | 5.44.107.00 |
| 5801637199 | 5.44.105.01 |
| 5801637201 | 5.44.104.00 |
| 5801637202 | 5.44.104.70 |
| 5801754885 | 2.42.088.00 |
| 5801754886 | 2.42.089.00 |
| 5801754888 | 2.42.072.00 |
| 5801754889 | 2.42.073.00 |
| 5801755123 | 2.41.050.00 |
| 5801755124 | 2.41.051.00 |
| 5801757326 | 5.44.106.70 |
| 5801757328 | 5.44.106.00 |
| 5801823334 | 2.42.068.12 |
| 5801823572 | 2.42.069.12 |

| | |
|--------------------|--------------------------|
| 5801988398 | 1.48.060.80 |
| 5802000568 | 5.44.101.81 |
| 5802000573 | 5.44.100.80 |
| 5802000767 | 5.44.100.78 |
| 5802055272 | 5.44.107.01 |
| 5802055273 | 5.44.103.81 |
| 5802062689 | 5.44.101.80 |
| 5802495899 | 2.42.069.15 |
| 5802495900 | 2.42.068.15 |
| 58012000770 | 5.44.102.80 |
| 58012000772 | 5.44.103.80 |
| JEEP | OLSA <i>Parts</i> |
| 51953114 | 1.02.168.00 |
| 51953116 | 1.02.169.00 |
| 51953123 | 1.04.194.00 |
| 51953205 | 1.04.195.00 |
| 51953208 | 1.05.114.00 |
| 51953209 | 1.06.090.00 |
| 51953210 | 1.06.091.00 |
| 51964233 | 5.04.250.00 |
| 51964234 | 5.04.251.00 |
| LAMBORGHINI | OLSA <i>Parts</i> |
| 4T0945095 | 1.04.283.00 |
| 4T0945096 | 1.04.282.00 |
| LANCIA | OLSA <i>Parts</i> |
| 7569564 | 1.05.070.00 |
| 46408283 | 1.02.136.00 |
| 46408284 | 1.02.137.00 |
| 46777262 | 2.01.056.00 |
| 46777263 | 2.01.057.00 |
| 46777264 | 1.02.110.12 |
| 46813514 | 1.02.144.12 |
| 51700163 | 1.04.092.00 |
| 51701517 | 1.05.090.12 |
| 51722723 | 1.05.058.00 |
| 51732445 | 1.04.080.10 |
| 51732445 | 1.04.081.10 |
| 51753386 | 1.04.078.18 |
| 51753386 | 1.04.079.18 |
| 51791660 | 1.06.070.00 |
| 51791661 | 1.06.071.00 |

| | |
|-------------------|--------------------------|
| 51798415 | 5.04.110.00 |
| 51798416 | 5.04.111.00 |
| 51798417 | 1.04.116.00 |
| 51808846 | 1.04.106.00 |
| 51808847 | 1.04.107.00 |
| 51808947 | 1.04.108.00 |
| 51808948 | 1.04.109.00 |
| 51809365 | 5.01.054.00 |
| 51809366 | 5.01.055.00 |
| 51810653 | 1.04.110.00 |
| 51833630 | 5.04.214.00 |
| 51833631 | 5.04.215.00 |
| 51839201 | 8.20.096.00 |
| 51839202 | 8.20.097.00 |
| 77363282 | 1.04.080.18 |
| 77363283 | 1.04.081.18 |
| 77363285 | 1.04.080.10 |
| 77363286 | 1.04.081.10 |
| 77364354 | 1.04.079.10 |
| 77364355 | 1.04.078.10 |
| 735443915 | 1.06.070.01 |
| LAND ROVER | OLSA <i>Parts</i> |
| XFB500020 | 2021001045 |
| XFB500030 | 2021101045 |
| MAN | OLSA <i>Parts</i> |
| 8252606099 | 2.43.132.80 |
| 81252256511 | 2.44.057.00 |
| 81252256524 | 2.44.177.01 |
| 81252606104 | 2.42.082.80 |
| 81253206084 | 2.41.062.00 |
| 81253206091 | 8.50.063.00 |
| 81253206092 | 8.50.062.00 |
| 81253206100 | 2.42.136.00 |
| 81253206102 | 2.42.142.00 |
| 81253206115 | 2.41.070.00 |
| 81253206118 | 2.41.072.00 |
| 7CE945095 | 5.44.117.00 |
| 7CE945096 | 5.44.116.00 |
| 81.25225-6563 | 2.44.335.81 |
| 81.25225-6564 | 2.44.334.80 |
| 8125225-6059 | 5.44.061.20 |

| | |
|-----------------|--------------------------|
| 8125225-6059 | 5.44.061.20 |
| 8125225-6060 | 5.44.060.20 |
| 8125225-6060 | 5.44.060.20 |
| 8125225-6443 | 2.44.176.00 |
| 8125225-6443 | 4.44.084.01 |
| 8125225-6544 | 5.44.061.00 |
| 8125225-6545 | 5.44.060.00 |
| 8125228-6029 | 2.44.121.00 |
| 8125228-6030 | 2.44.120.00 |
| 8125320-6113 | 8.50.065.00 |
| 8125320-6114 | 8.50.064.00 |
| MASERATI | OLSA <i>Parts</i> |
| 670004663 | 1.04.226.00 |
| 670004682 | 1.04.227.00 |
| 670008481 | 1.04.224.00 |
| 670008482 | 1.04.225.00 |
| 06701546060 | 1.04.228.00 |
| 06701546080 | 1.04.230.00 |
| 06701546090 | 1.04.229.00 |
| 06701546110 | 1.04.231.00 |
| 06701586880 | 1.04.310.00 |
| 06701596950 | 1.04.311.00 |
| 06701596970 | 1.04.312.00 |
| 06701596980 | 1.04.313.00 |
| MERCEDES | OLSA <i>Parts</i> |
| 0015401470 | 2.44.172.00 |
| 0015401770 | 2.44.173.01 |
| 0025447390 | 2.44.326.20 |
| 0028205056 | 2.43.335.80 |
| 0028205156 | 2.43.334.80 |
| 0035442503 | 2.44.324.00 |
| 0035442603 | 2.44.325.01 |
| 0035442703 | 2.44.324.70 |
| 0035445603 | 2.44.185.01 |
| 0035445703 | 2.44.184.00 |
| 38203256 | 2.41.332.80 |
| 2028201521 | 2.02.186.12 |
| 2108200921 | 2.02.184.12 |
| 3148102016 | 68.5.200.025 |
| 6398200164 | 2.44.301.10 |
| 6398200264 | 2.44.300.10 |

| | |
|---------------|-------------|
| 9068200456 | 2.44.327.00 |
| 9408200321 | 2.41.065.00 |
| 9408200421 | 2.41.064.00 |
| 9418200721 | 2.42.135.00 |
| 9738200121 | 2.41.331.00 |
| 9738200221 | 2.41.330.00 |
| 9738200521 | 2.41.089.00 |
| 9738200621 | 2.41.088.00 |
| 81252256141 | 2.44.125.00 |
| 81252256141 | 2.44.127.01 |
| 81252256198 | 2.44.124.00 |
| 000 820 12 77 | 5.42.062.99 |
| 001 822 89 20 | 5.42.063.00 |
| 001 822 90 20 | 5.42.062.00 |
| 001 822 93 20 | 5.42.065.00 |
| A0005441804 | 2.44.132.00 |
| A0005442407 | 2.44.136.00 |
| A0005445411 | 2.42.058.80 |
| A0008205064 | 2.44.296.00 |
| A0008205064 | 2.44.297.00 |
| A0008261556 | 2.44.063.00 |
| A0008261556 | 2.44.063.10 |
| A0008261656 | 2.44.062.00 |
| A0008261656 | 2.44.062.10 |
| A0008261656 | 2.44.062.18 |
| A0015446803 | 2.44.118.00 |
| A0015448003 | 2.44.119.01 |
| A0015448390 | 2.44.118.20 |
| A0015449290 | 2.44.136.25 |
| A0015449490 | 2.44.128.21 |
| A0018227520 | 2.02.068.00 |
| A0025440690 | 2.44.079.00 |
| A0025440790 | 2.44.081.01 |
| A0025444790 | 2.44.182.20 |
| A0025445403 | 2.44.182.00 |
| A0025445503 | 2.44.183.01 |
| A0025447390 | 2.44.276.10 |
| A0035441603 | 2.44.276.00 |
| A0035441703 | 2.44.277.01 |
| A0035441803 | 2.44.276.70 |
| A0035443203 | 2.44.337.81 |

| | |
|-------------|-------------|
| A1248260743 | 2.01.131.00 |
| A1248260843 | 2.01.130.00 |
| A1698200521 | 5.02.077.00 |
| A1698200621 | 5.02.076.00 |
| A1769064800 | 1.04.221.00 |
| A1769064900 | 1.04.220.00 |
| A1769065000 | 1.04.235.06 |
| A1769065100 | 1.04.222.00 |
| A1769065300 | 1.04.223.00 |
| A1769065400 | 1.04.234.06 |
| A2038201321 | 5.02.117.00 |
| A2038201421 | 5.02.116.00 |
| A2038201521 | 5.02.083.00 |
| A2038201621 | 5.02.082.00 |
| A2048200721 | 5.02.111.80 |
| A2048200821 | 5.02.110.80 |
| A2198200521 | 5.02.119.00 |
| A2198200621 | 5.02.118.00 |
| A4638220020 | 2.02.070.00 |
| A4639064201 | 1.04.284.00 |
| A4639065301 | 1.04.285.06 |
| A4639068100 | 1.04.286.00 |
| A4639068300 | 1.04.287.06 |
| A6398260440 | 5.06.069.00 |
| A6398260540 | 5.06.068.00 |
| A9018200121 | 2.41.097.00 |
| A9018200221 | 2.42.056.11 |
| A9068200164 | 2.44.077.10 |
| A9068200164 | 5.44.077.00 |
| A9068200264 | 2.44.076.10 |
| A9068200264 | 5.44.076.00 |
| A9068200464 | 5.44.071.01 |
| A9068201764 | 5.44.070.00 |
| A9068262056 | 5.44.071.20 |
| A9068262056 | 5.44.071.20 |
| A9068262456 | 5.44.070.20 |
| A9068262456 | 5.44.070.20 |
| A9418200521 | 2.41.074.00 |
| A9418200921 | 2.41.074.00 |
| A9418201021 | 2.41.080.00 |
| A9608201021 | 2.42.095.00 |

| | |
|-------------|--------------------------|
| A9608201121 | 2.42.094.00 |
| A9678200121 | 2.41.133.00 |
| A9678200221 | 2.41.132.00 |
| A9678200321 | 2.41.133.80 |
| A9678200421 | 2.41.132.80 |
| A9738200321 | 2.42.097.00 |
| A9738200421 | 2.42.096.00 |
| A9738200521 | 2.41.096.00 |
| MINI | OLSA <i>Parts</i> |
| 899816720 | 1.05.116.12 |
| 51132752243 | 1.04.119.17 |
| 51132752244 | 1.04.118.17 |
| 52109806935 | 1.04.181.17 |
| 52109806936 | 1.04.180.17 |
| 63132751331 | 1.02.175.00 |
| 63132751332 | 1.02.174.00 |
| 63132751333 | 1.02.177.00 |
| 63132751334 | 1.02.176.00 |
| 63137260201 | 1.02.165.00 |
| 63137260202 | 1.02.164.00 |
| 63137260203 | 1.02.166.00 |
| 63137260204 | 1.02.167.00 |
| 63137298337 | 1.02.175.80 |
| 63137298338 | 1.02.174.80 |
| 63137298347 | 1.02.181.00 |
| 63137298348 | 1.02.180.00 |
| 63212754529 | 1.04.129.00 |
| 63212754530 | 1.04.128.00 |
| 63212757009 | 1.04.119.00 |
| 63212757010 | 1.04.118.00 |
| 63212757011 | 1.04.121.00 |
| 63212757012 | 1.04.120.00 |
| 63217167411 | 1.04.127.00 |
| 63217167412 | 1.04.126.00 |
| 63217255909 | 1.04.175.00 |
| 63217255910 | 1.04.174.00 |
| 63217255911 | 1.04.177.00 |
| 63217255912 | 1.04.176.00 |
| 63217255913 | 1.04.289.16 |
| 63217255914 | 1.04.288.16 |
| 63217255915 | 1.04.167.00 |

| | |
|-------------|-------------|
| 63217255916 | 1.04.166.00 |
| 63217275119 | 1.04.171.00 |
| 63217275120 | 1.04.170.00 |
| 63217275121 | 1.04.173.06 |
| 63217275122 | 1.04.172.06 |
| 63217297413 | 1.04.259.00 |
| 63217297414 | 1.04.258.00 |
| 63217297433 | 1.04.261.00 |
| 63217297434 | 1.04.260.00 |
| 63217297547 | 1.02.177.80 |
| 63217297548 | 1.02.176.80 |
| 63217352153 | 1.04.267.00 |
| 63217352154 | 1.04.266.00 |
| 63217352155 | 1.04.265.00 |
| 63217352156 | 1.04.264.00 |
| 63217352157 | 1.04.269.00 |
| 63217352158 | 1.04.268.00 |
| 63217401715 | 1.04.273.00 |
| 63217401716 | 1.04.272.00 |
| 63217401717 | 1.04.273.06 |
| 63217401718 | 1.04.272.06 |
| 63217401723 | 1.04.271.00 |
| 63217401724 | 1.04.270.00 |
| 63217401725 | 1.04.271.06 |
| 63217401726 | 1.04.270.06 |
| 63217435133 | 1.04.233.00 |
| 63217435134 | 1.04.232.00 |
| 63217435135 | 1.04.233.16 |
| 63217435136 | 1.04.232.16 |
| 63217475581 | 1.04.267.00 |
| 63217475582 | 1.04.266.00 |
| 63217475584 | 1.04.264.00 |
| 63217475585 | 1.04.265.00 |
| 63219477149 | 1.04.273.00 |
| 63219477150 | 1.04.272.00 |
| 63219477151 | 1.04.273.06 |
| 63219477152 | 1.04.272.06 |
| 63219477153 | 1.04.271.00 |
| 63219477154 | 1.04.270.00 |
| 63219477155 | 1.04.271.06 |
| 63219477156 | 1.04.270.06 |

| | |
|---------------|--------------------------|
| 63219807184 | 1.04.182.06 |
| 63219807812 | 1.04.182.06 |
| 63219808149 | 1.04.181.00 |
| 63219808150 | 1.04.180.00 |
| 63219808151 | 1.04.183.06 |
| 63219808154 | 1.04.182.06 |
| 63242751707 | 1.04.125.00 |
| 63242751708 | 1.04.124.00 |
| 63246946904 | 1.04.122.00 |
| 63246946904 | 1.04.122.00 |
| 63247255925 | 1.04.178.00 |
| 63247350007 | 1.04.263.00 |
| 63247350008 | 1.04.262.00 |
| 63262755711 | 1.05.112.00 |
| NISSAN | OLSA <i>Parts</i> |
| 260109X204 | 8.40.076.00 |
| 26010MB41A | 8.40.080.00 |
| 260609X204 | 8.40.077.00 |
| 26060MB41A | 8.40.081.00 |
| 26124-3T900 | 2.41.068.10 |
| 26129-3T900 | 2.41.069.10 |
| 26160BV80A | 5.02.120.80 |
| 26165BV80A | 5.02.121.80 |
| 26554-9X126 | 2.44.066.20 |
| 26555-9X125 | 2.44.066.00 |
| 26555-9X126 | 2.44.067.00 |
| OPEL | OLSA <i>Parts</i> |
| 4401956 | 2.44.319.10 |
| 4401957 | 2.44.318.10 |
| 4413002 | 5.44.139.00 |
| 4413003 | 5.44.140.00 |
| 4413004 | 5.44.141.00 |
| 4413005 | 5.44.138.00 |
| 4413006 | 5.44.135.00 |
| 4413007 | 5.44.136.00 |
| 4413008 | 5.44.137.00 |
| 4413009 | 5.44.134.00 |
| 4413010 | 5.44.133.00 |
| 4413011 | 5.44.132.00 |
| 4413012 | 5.44.131.00 |
| 4413013 | 5.44.130.00 |

| | |
|----------------|--------------------------|
| 4419378 | 2.44.261.10 |
| 4419379 | 2.44.260.10 |
| 4422465 | 2.44.294.10 |
| 4422466 | 2.44.295.10 |
| 4422484 | 1.44.105.00 |
| 4422487 | 1.44.104.00 |
| 9164143 | 1.05.098.00 |
| 13139990 | 1.05.100.00 |
| 13191554 | 1.02.102.12 |
| 93190306 | 2021101049 |
| 93190307 | 2021001049 |
| PAGG | OLSA <i>Parts</i> |
| 13.5626.940 | 3.49.095.00 |
| 13.5626.950 | 3.49.094.00 |
| 18-8570-001 | 7.44.097.20 |
| 18-8570-101 | 7.44.096.20 |
| 25-3800-507 | 7.44.091.80 |
| 25-3900-507 | 7.44.090.80 |
| 25-7000-507 | 7.44.093.00 |
| 25-7000-707 | 7.44.097.80 |
| 25-7000-727 | 7.44.095.80 |
| 25-7400-507 | 7.44.092.00 |
| 25--7400-707 | 7.44.096.80 |
| 25--7400-727 | 7.44.094.80 |
| KM 21.2200.014 | 7.43.080.81 |
| KM 26.3010.004 | 7.45.052.00 |
| KM 31.2064.007 | 7.43.074.81 |
| KM 31.2064.717 | 7.43.078.81 |
| KM 31.2214.007 | 7.43.084.81 |
| KM 31.2814.007 | 7.43.060.31 |
| KM 31.5064.027 | 7.43.064.41 |
| KM 31.6614.017 | 7.43.086.81 |
| KS 18.8522.002 | 7.44.054.20 |
| KS 18.8560.002 | 7.44.050.20 |
| KS 18.8560.002 | 7.44.050.20 |
| KS 18.8560.002 | 7.44.050.20 |
| KS 25.2200.007 | 7.44.055.00 |
| KS 25.2600.007 | 7.44.054.00 |
| KS 25.6000.507 | 7.44.051.00 |
| KS 25.6400.507 | 7.44.050.00 |
| KS 31.3304.047 | 7.43.071.80 |

| | | | | | |
|----------------|-------------------|------------|-------------|--------------------|-------------------|
| KS 31.3304.057 | 7.43.070.80 | 5001834561 | 5.43.060.00 | 8200336833 | 5.44.137.00 |
| KS18.8528.002 | 7.44.061.20 | 5001834565 | 2.43.218.00 | 8200336834 | 5.44.136.00 |
| KS18.8529.002 | 7.44.060.20 | 5001834565 | 5.43.058.00 | 8200336835 | 5.44.135.00 |
| KS25.2800.507 | 7.44.060.00 | 5001847153 | 2.44.066.20 | 8200336836 | 5.44.134.00 |
| KS25.2900.507 | 7.44.061.00 | 5001862030 | 2.42.078.00 | 8200336837 | 5.44.133.00 |
| KS25.6011.517 | 7.44.059.00 | 5001862030 | 5.43.056.00 | 8200336839 | 5.44.132.00 |
| KS25.6200.507 | 7.44.057.00 | 5001864535 | 2.44.177.01 | 8200336840 | 5.44.131.00 |
| KS25.6411.517 | 7.44.058.00 | 5001864537 | 2.44.176.00 | 8200336841 | 5.44.130.00 |
| KS25.6600.507 | 7.44.056.00 | 5001870556 | 2.44.066.00 | 8200379188 | 1.02.116.12 |
| T40.292.312 | 7.44.099.80 | 5010217022 | 2.41.334.00 | 8200419941 | 2.04.107.10 |
| T40-292-311 | 7.44.098.80 | 5010271807 | 2.41.333.00 | 8200419945 | 2.04.106.10 |
| PEUGEOT | OLSA Parts | 7420802348 | 5.44.067.00 | 8200419949 | 2.04.109.10 |
| 1353205080 | 2.04.062.10 | 7420802350 | 5.44.066.00 | 8200419952 | 2.04.108.10 |
| 1353205080 | 5.04.172.00 | 7420802418 | 5.44.066.20 | 8200439492 | 1.02.172.12 |
| 1353206080 | 2.04.063.10 | 7422800385 | 5.44.109.80 | 260100652R | 8.10.116.00 |
| 1353206080 | 5.04.173.00 | 7422800385 | 5.44.109.80 | 260103127R | 8.10.114.00 |
| 1358249080 | 2.04.060.10 | 7422800386 | 5.44.108.81 | 260106624R | 8.10.112.00 |
| 1358250080 | 2.04.061.10 | 7422800391 | 5.44.108.20 | 260601176R | 8.10.115.00 |
| 1607512580 | 5.02.101.12 | 7422800391 | 5.44.108.20 | 260603442R | 8.10.113.00 |
| 1607512680 | 5.02.100.12 | 7423080010 | 5.44.108.80 | 260608629R | 8.10.117.00 |
| 2VP354677011 | 2021101038 | 7425982261 | 5.44.109.80 | 261650001R | 5.02.126.00 |
| 2VP354677021 | 2021001038 | 7425982261 | 5.44.109.80 | 261650002R | 5.02.127.00 |
| 6350CE | 2021101037 | 7425982262 | 5.44.108.81 | 265103161R | 1.05.122.00 |
| 6351CE | 2021001037 | 7482622149 | 2.41.130.80 | 265504656R | 2.44.294.10 |
| PORSCHE | OLSA Parts | 7482622233 | 2.41.131.80 | 265506145R | 2.04.110.10 |
| 95863110131 | 5.02.123.80 | 7482622237 | 8.40.108.60 | 265506747R | 2.04.112.10 |
| 95863110231 | 5.02.122.80 | 7482622259 | 8.40.109.60 | 265540003R | 1.04.148.00 |
| 99163116505 | 1.04.291.00 | 7485118470 | 2.44.067.00 | 265549399R | 1.44.105.00 |
| 99163116605 | 1.04.290.00 | 7485120619 | 5.42.066.12 | 265556737R | 2.44.295.10 |
| 99163125506 | 1.02.185.00 | 7485120620 | 5.42.068.12 | 265557352R | 2.04.111.10 |
| 99163125606 | 1.02.184.00 | 7485120621 | 5.42.069.12 | 265559212R | 2.04.113.10 |
| 99163146502 | 1.04.294.00 | 7485120622 | 5.42.067.12 | 265598668R | 1.44.104.00 |
| 99163197302 | 1.04.293.00 | 7700353184 | 1.46.050.00 | 265800001R | 1.04.185.00 |
| 99163197402 | 1.04.292.00 | 7701044522 | 5.41.063.00 | 265850001R | 1.04.184.00 |
| 971949101B | 5.02.125.80 | 7701044523 | 5.41.062.00 | 265850007R | 1.04.149.00 |
| 971949102B | 5.02.124.80 | 7701047516 | 2.02.192.12 | 8200013577F | 1.05.110.00 |
| RENAULT | OLSA Parts | 8200209522 | 1.44.094.00 | ROLLS ROYCE | OLSA Parts |
| 93854773 | 1.45.060.00 | 8200336826 | 5.44.141.00 | 748619308 | 1.04.299.80 |
| 5001834559 | 2.41.060.00 | 8200336830 | 5.44.140.00 | 748619408 | 1.04.298.80 |
| 5001834560 | 2.41.061.00 | 8200336831 | 5.44.139.00 | SCANIA | OLSA Parts |
| 5001834561 | 2.41.326.00 | 8200336832 | 5.44.138.00 | 1365973 | 2.42.137.80 |

| | |
|---------------|--------------------------|
| 1380445 | 2.44.179.01 |
| 1380446 | 2.44.178.00 |
| 1380819 | 2.44.178.20 |
| 1385410 | 2.41.087.27 |
| 1387155 | 2.41.086.27 |
| 1446359 | 2.42.100.80 |
| 1471599 | 2.42.080.80 |
| 1498102 | 2.44.181.01 |
| 1508176 | 2.44.180.00 |
| 1747981 | 2.41.092.00 |
| 1756751 | 5.44.072.00 |
| 1756754 | 5.44.073.01 |
| 1770301 | 2.42.092.00 |
| 1798980 | 2.43.140.80 |
| 1905043 | 2.44.328.80 |
| 1905044 | 2.44.329.81 |
| 1949900 | 2.41.098.80 |
| 2027555 | 2.44.329.20 |
| 2027556 | 2.44.328.20 |
| 2160128 | 5.44.111.00 |
| 2241859 | 2.44.328.80 |
| 2241860 | 2.44.329.81 |
| 2340796 | 5.44.110.00 |
| 2380954 | 2.44.328.81 |
| 2442637 | 2.41.329.80 |
| 2442639 | 2.41.328.80 |
| 21735299 | 5.44.118.80 |
| 21735301 | 5.44.119.80 |
| 82483074 | 5.44.119.81 |
| 84441759 | 5.44.119.81 |
| 84441936 | 5.44.119.80 |
| 84441937 | 5.44.118.80 |
| SEAT | OLSA <i>Parts</i> |
| 2K0949117A | 1.02.132.12 |
| 5P8.945.111 A | 2021101046 |
| 5P8.945.112 A | 2021001046 |
| SETRA | OLSA <i>Parts</i> |
| A6295400645 | 2.42.062.80 |
| SKODA | OLSA <i>Parts</i> |
| 1Z1 941 017 P | 2020101040 |
| 1Z1 941 018 P | 2020001040 |

| | |
|---------------|--------------------------|
| 1Z5945111A | 2021101019 |
| 1Z5945112A | 2021001019 |
| 2198 2819 | 1.02.155.00 |
| 2198 2820 | 1.02.154.00 |
| 379 945 095A | 1.04.161.00 |
| 379 945 095B | 1.04.163.00 |
| 3T0949101 | 5.02.129.00 |
| 3T0949102 | 5.02.128.00 |
| 3T5 945 093A | 1.04.157.00 |
| 3T5 945 093B | 1.04.159.00 |
| 3T5 945 094 B | 1.04.158.00 |
| 3T5 945 094A | 1.04.156.00 |
| 3T5 945 095A | 1.04.155.00 |
| 3T5 945 096A | 1.04.154.00 |
| 3T9 945 096A | 1.04.160.00 |
| 3T9 945 096B | 1.04.162.00 |
| 3V0949101 | 5.02.133.80 |
| 3V0949102 | 5.02.132.80 |
| 5E0949101 | 5.02.131.80 |
| 5E0949102 | 5.02.130.80 |
| 5J6 945 111 | 2021101047 |
| 5J6 945 112 | 2021001047 |
| 5L0949101 | 5.02.135.00 |
| 5L0949101A | 5.02.137.00 |
| 5L0949101B | 5.02.139.00 |
| 5L0949102 | 5.02.134.00 |
| 5L0949102A | 5.02.136.00 |
| 5L0949102B | 5.02.138.00 |
| 6V0949100 | 5.02.103.12 |
| 6V0949101 | 5.02.102.12 |
| TOYOTA | OLSA <i>Parts</i> |
| 8173002110 | 5.02.140.00 |
| 8173052010 | 1.02.158.00 |
| 8174002020 | 5.02.141.00 |
| 8174052010 | 1.02.159.00 |
| 811300D120 | 8.00.072.00 |
| 811700D120 | 8.00.073.00 |
| 815510H070 | 5.04.208.10 |
| 815610H070 | 5.04.209.10 |
| 817310D080 | 5.02.142.00 |
| 817410D020 | 5.02.143.00 |

| | |
|-------------------|--------------------------|
| UNIVERSAL | OLSA <i>Parts</i> |
| 10588098 | 1.09.051.00 |
| 99441273 | 2.41.076.00 |
| 7782324011 | 2.47.050.00 |
| 7782324020 | 2.47.050.00 |
| VOLKSWAGEN | OLSA <i>Parts</i> |
| 11A945076 | 1.04.342.00 |
| 11A945095 | 1.04.347.00 |
| 11A945095A | 1.04.347.16 |
| 11A945096 | 1.04.346.00 |
| 11A945096A | 1.04.346.16 |
| 11A945207A | 1.04.345.80 |
| 11A945208A | 1.04.344.80 |
| 11A945276B | 1.04.340.80 |
| 11A945428905 | 1.04.348.17 |
| 1J0949117 | 1.02.120.12 |
| 1K0949102 | 1.02.122.00 |
| 1K0949103 | 1.02.123.00 |
| 1Z0949101C | 1.02.151.00 |
| 1Z0949102C | 1.02.150.00 |
| 2D0945095 | 2.44.113.00 |
| 2D0945096C | 2.44.112.00 |
| 2D0945111C | 2.44.113.00 |
| 2D0945112 | 2.44.112.00 |
| 2K1945095E | 2.04.121.10 |
| 2K1945096F | 2.04.120.10 |
| 2K7945095 | 1.04.339.00 |
| 2K7945096 | 1.04.338.00 |
| 2K7945207D | 1.04.339.80 |
| 2K7945208D | 1.04.338.80 |
| 3G5945093D | 1.04.363.80 |
| 3G5945093F | 1.04.363.06 |
| 3G5945094D | 1.04.362.80 |
| 3G5945094F | 1.04.362.06 |
| 3G5945095E | 1.04.365.80 |
| 3G5945096E | 1.04.364.80 |
| 3G9945093H | 1.04.359.80 |
| 3G9945093J | 1.04.359.06 |
| 3G9945094H | 1.04.358.80 |
| 3G9945094J | 1.04.358.06 |
| 3G9945095E | 1.04.361.80 |

| | |
|--------------|--------------------------|
| 3G9945096E | 1.04.360.80 |
| 5M0945095L | 5.04.135.00 |
| 5M0945096L | 5.04.134.00 |
| 5N0949101E | 1.02.157.00 |
| 5N0949102E | 1.02.156.00 |
| 5NA949101 | 5.02.147.80 |
| 5NA949101A | 5.02.149.80 |
| 5NA949102 | 5.02.146.80 |
| 5NA949102A | 5.02.148.80 |
| 6N0953041N | 2.01.075.00 |
| 6N0953042N | 2.01.074.00 |
| 7E0945095T | 2.44.307.10 |
| 7E0945096T | 2.44.306.10 |
| 7H0945095F | 2.44.311.10 |
| 7H0945095G | 2.44.311.10 |
| 7H0945096F | 2.44.310.10 |
| 7H0945096G | 2.44.310.10 |
| 7H5945095F | 2.44.309.10 |
| 7H5945095H | 2.44.309.10 |
| 7H5945096F | 2.44.308.10 |
| 7H5945096H | 2.44.308.10 |
| 7K0949117 | 1.02.100.12 |
| 7LA945095A | 1.04.351.00 |
| 7LA945095D | 1.04.351.06 |
| 7LA945095E | 1.04.357.00 |
| 7LA945095F | 1.04.357.06 |
| 7LA945096A | 1.04.350.00 |
| 7LA945096C | 1.04.356.06 |
| 7LA945096D | 1.04.350.06 |
| 7LA945096E | 1.04.356.00 |
| 7LA945207 | 1.04.353.80 |
| 7LA945207A | 1.04.355.80 |
| 7LA945208 | 1.04.352.80 |
| 7LA945208A | 1.04.354.80 |
| VOLVO | OLSA <i>Parts</i> |
| 1371975 | 2.44.188.00 |
| 1387877 | 2.44.189.01 |
| 3981455 | 2.44.187.01 |
| 3981456 | 2.44.186.00 |
| 3981460 | 2.44.175.01 |
| 3981461 | 2.44.174.00 |

| | |
|----------|-------------|
| 3981666 | 2.41.118.00 |
| 3981668 | 2.41.082.00 |
| 3981782 | 2.44.174.20 |
| 8191146 | 2.41.084.00 |
| 11170068 | 5.42.072.80 |
| 20398660 | 2.42.098.80 |
| 20409874 | 2.42.053.00 |
| 20409875 | 2.42.052.00 |
| 20425728 | 2.44.293.01 |
| 20425729 | 2.44.292.00 |
| 20425732 | 2.44.292.20 |
| 20565103 | 2.44.291.01 |
| 20565106 | 2.44.290.00 |
| 20565107 | 2.44.290.20 |
| 20789440 | 2.42.100.80 |
| 20789440 | 5.42.076.80 |
| 21087346 | 2.43.330.80 |
| 21087347 | 2.43.332.80 |
| 21346521 | 2.42.139.80 |
| 21346522 | 2.42.138.80 |
| 21735299 | 5.44.118.80 |
| 21735301 | 5.44.119.80 |
| 23354972 | 5.44.109.80 |
| 23354972 | 5.44.109.80 |
| 23354973 | 5.44.108.81 |
| 23354974 | 5.44.108.80 |
| 31385685 | 5.02.145.80 |
| 31385686 | 5.02.144.80 |
| 70305316 | 2.43.114.00 |
| 82114500 | 2.43.131.80 |
| 82114506 | 2.43.130.80 |
| 82116545 | 2.43.331.80 |
| 82151157 | 2.42.141.80 |
| 82151205 | 2.42.140.80 |
| 82446490 | 2.41.337.00 |
| 82446491 | 2.41.336.00 |
| 82483074 | 5.44.119.81 |
| 82849894 | 5.44.109.80 |
| 82849894 | 5.44.109.80 |
| 82849905 | 5.44.108.20 |
| 82849905 | 5.44.108.20 |

| | |
|----------|-------------|
| 82849923 | 5.44.108.80 |
| 82849925 | 5.44.108.81 |
| 84122332 | 5.44.118.20 |
| 84195519 | 5.44.108.81 |
| 84195521 | 5.44.108.80 |
| 84441759 | 5.44.119.81 |
| 84441767 | 5.44.108.81 |
| 84441768 | 5.44.108.80 |
| 84441936 | 5.44.119.80 |
| 84441937 | 5.44.118.80 |

CONDIZIONI GENERALI DI VENDITA

1. Le presenti Condizioni Generali di Vendita si applicano a tutti gli ordini accettati da OLSA Parts s.r.l. (di seguito anche "OLSA") Condizioni difformi da quelle riportate saranno valide solo se redatte in forma scritta.
2. La conferma degli ordini ricevuti da OLSA potrà avvenire, entro il termine massimo di 60 giorni dalla ricezione dell'ordine medesimo, tramite accettazione tacita - cioè mediante invio diretto al cliente della merce oggetto dell'ordine - oppure tramite accettazione scritta.
3. Le condizioni di resa sono regolate secondo quanto previsto dagli accordi tra OLSA ed i suoi Clienti, e riepilogate nei documenti di trasporto emessi da OLSA.
4. Eventuali manomissioni e/o effrazioni dei colli ricevuti dovranno essere contestate direttamente al corriere, al momento del ritiro della merce.
5. Ogni reclamo inerente alla quantità della merce ricevuta o alla non corrispondenza della stessa con l'ordine dovrà esserci comunicato via PEC o raccomandata a/r entro e non oltre 8 giorni dalla data del ritiro della merce, anticipando via mail o fax tale comunicazione entro il medesimo termine in caso di raccomandata a/r. Se la differenza tra ordine e spedizione risulta essere causata da un errore di ordinazione imputabile al cliente, verrà ad esso addebitato il 20% del valore della merce resa per costi di ripristino magazzino.
6. Ogni reclamo inerente alla qualità della merce dovrà esserci trasmesso non appena riscontrato, in ogni caso non oltre la fine dell'anno solare nel quale la merce è stata ricevuta.
7. Con riferimento ai punti 5 e 6, verranno respinti resi di materiale non preventivamente autorizzati, e quindi nessuna sostituzione del materiale potrà essere effettuata se non prima concordata con i nostri uffici.
8. Per quanto riguarda i difetti soggetti alle garanzie legali di conformità, è fatto salvo quanto previsto dalla legge.
9. I prezzi di listino possono essere soggetti a variazioni e sconti anche in dipendenza di azioni promozionali ed operazioni speciali.
10. Il pagamento deve avvenire nei termini e nelle forme pattuite e per l'intero importo della fattura.
11. In caso di mancato pagamento e/o grave ritardo nell'effettuazione dello stesso, OLSA si riserva il diritto di agire in giudizio senza previa necessità di messa in mora per il recupero di quanto a lei spettante, comprensivo di ogni accessorio di legge.
12. È vietata la riproduzione, anche parziale, del contenuto del presente catalogo senza preventiva autorizzazione scritta di OLSA.
13. OLSA ha curato con particolare attenzione la stesura del presente catalogo; declina comunque ogni responsabilità per eventuali errori di immagini, disegni, corrispondenze con codici O.E. e si riserva il diritto di apportare modifiche al contenuto senza obbligo di preavviso.
14. Per qualsiasi controversia unico foro competente in via esclusiva sarà quello di Torino.

GENERAL SALES CONDITIONS TERMS

1. The following General Sale Conditions are applicable to all orders accepted by OLSA Parts s.r.l. (hereby also referred to as "OLSA"). Different conditions are deemed applicable only if in written form.
2. Confirmation of orders received by OLSA shall be made, within a maximum of 60 days from the receipt of the order, by tacit acceptance - that is, through delivery to the customer of the goods object of the order - or by written acceptance.
3. The delivery conditions are regulated in accordance with the agreements between OLSA and its customers and summarized in the transport documents issued by OLSA.
4. Tampering and/or break-ins of packages received must be challenged directly to the carrier at the time of receipt of the goods.
5. Any claim related to the quantity of the goods received or to the non-correspondence of the goods with the purchase order must be communicated via PEC or registered letter (with receipt) within 8 days from the date of receipt of goods, anticipating by e-mail or fax the notice, within the same timeframe in case of registered letter. If the difference between order and shipment results to be caused by a mistake of ordering due to the customer, OLSA will charge 20% of the value of goods delivered for costs of warehouse recovery.
6. Any complaint concerning the quality of goods must be sent when the defect is discovered, and in any case no later than the end of the calendar year in which the goods have been received.
7. With reference to paragraphs 5 and 6, returns of goods not previously authorized will be rejected, and therefore no substitution of goods shall be made if not previously agreed with our offices.
8. With regards to defects subject to legal guarantees of conformity, the governing law shall prevail.
9. Price lists can be subject to variations and discounts depending on promotional activities and special operations.
10. Payments must be made within the time limits and in the forms agreed and for the full amount of the invoices.
11. In the event of non-payment and/or delay in the payment itself, OLSA reserves the right to take legal action without the express need for formal notice for recovery of the due amount, to be inclusive of all accessories provided by the law.
12. It is forbidden to reproduce, even partially, the contents of this catalogue without prior written permission of OLSA.
13. OLSA has drafted this catalogue with the necessary required attention; OLSA declines all responsibility for any errors of images, drawings, correspondence with O.E. codes and reserves the right to make changes in the content without obligation of notification.
14. Exclusive jurisdiction for any disputes shall be the Court of Turin.

OLSA *Parts*

Corso Allamano, 70
10098 RIVOLI (TO) | Italia
tel. +39.011.64.74.394
fax +39.011.64.74.395
www.olsaparts.it



8 033576 348896

Cod. 9.99.000.10 omaggio