



PROMODAY
2021
ITALIA € IVA ESCLUSA



| | | |
|---|------------------------------------|-----------|
|  | CHIAVI DI MANOVRA | 2 |
|  | CHIAVI A BUSSOLA | 6 |
|  | GIRAVITI E PINZE | 16 |
|  | ELETTROTECNICA/ELETTRICITA' | 20 |
|  | UTENSILI DINAMOMETRICI | 22 |
|  | MANUTENZIONE GENERALE | 24 |
|  | VALIGIE PORTA-UTENSILI | 30 |
|  | ESTRATTORI | 32 |
|  | UTENSILI PNEUMATICI | 34 |
|  | AUTOMOTIVE | 42 |
|  | CARRELLI E BANCHI DA LAVORO | 58 |
|  | ARREDAMENTO TECNICO | 88 |
|  | EQUIPMENT | 94 |



CHIAVI DI MANOVRA

LA CLASSICA

ANELLO POSTERIORE
INCLINATO A 15°

FINITURA
SATINATA LUCIDA

CORPO CENTRALE INCAVO
PER UNA MAGGIORE PRESA

BOCCA ANTERIORE
RINFORZATA



FG 600/SC17

SET 17 CHIAVI COMBinate
POLIGONALI IN BOX DI CARTONE

CONTENUTO:
6, 7, 8, 9, 10, 11, 12, 13, 14,
15, 16, 17, 18, 19, 20, 21, 22 mm



~~156,50€~~ 92,50€

FG 600/SC16

SET 16 CHIAVI
COMBinate POLIGONALI

CONTENUTO:
6,7,8,10,12,13,14,16,
17,19,21,22,24,27,30,32 mm



~~197,80€~~ 109,00€

FG 600/ST9

SET 9 CHIAVI COMBinate
POLIGONALI CON
SUPPORTO IN ABS

CONTENUTO:
8,10,11,12,13,14,15,17,19 mm



~~83,10€~~ 49,90€

FG 600/SC25

SET 25 CHIAVI COMBinate
POLIGONALI IN BOX DI CARTONE

CONTENUTO:
6, 7, 8, 9, 10, 11, 12, 13, 14, 15, 16,
17,18, 19, 20, 21, 22, 23, 24, 25, 26, 27,
28, 30,32 mm



~~315,80€~~ 169,00€

EXTRA-PIATTA

FG 602C/SP9

SET CHIAVI A DOPPIA FORCHETTA
ULTRA PIATTE IN ROTOLO DI NYLON

CONTENUTO:
6x7,8x9,x10x11,x12x13,14x15,
16x17,18x19, 20x22,21x23

~~74,00€~~ 39,90€



FG 602/ST7

SET CHIAVI A DOPPIA FORCHETTA
CON SUPPORTO IN ABS

CONTENUTO:
6x7, 8x9, 10x11, 12x13,
14x15, 16x17, 18x19mm

~~39,00€~~ 22,90€





FG 609A/S5

**SET 5 CHIAVI
DOPPIE POLIGONALI**

CONTENUTO:
10x12, 11x13,
14x17, 16x18, 19x22

~~77,50€~~

46,50€

FG 613/S9

**SET CHIAVI A PIPA
ESAGONALI-POLIGONALI
IN BOX DI CARTONE**

CONTENUTO:
8, 10, 11, 12, 13, 15, 17,
18, 19 mm

~~135,00€~~

79,00€



FG 619H/S5

**SET CHIAVI A T MASCHIO ESAGONALI
SNODATE IN BOX DI CARTONE**

CONTENUTO:
3, 4, 5, 6, 8, mm

~~138,00€~~

82,90€



**SNODO CARDANICO
ALTAMENTE
RINFORZATO**

FG 618/S7B

**SET 7 CHIAVI A T
SNODATE ESAGONALI**

CONTENUTO:
7, 8, 10, 12, 13, 14, 17mm

~~195,00€~~

119,00€



FG 619TX/S8

**SET CHIAVI A T SNODATE
TORX IN BOX DI CARTONE**

CONTENUTO:
TX20, 25, 27, 30, 40, 45, 50, 55

~~265,00€~~

156,00€



FG 618/S7

**SET 7 CHIAVI A T
SNODATE ESAGONALI**

CONTENUTO:
8, 10, 11, 13, 14, 17, 19 mm

~~220,00€~~

129,00€



FG 618/S10

**SET 10 CHIAVI A T
SNODATE ESAGONALI**

CONTENUTO:
8, 10, 11, 12, 13, 14,
15, 16, 17, 19 mm

~~330,00€~~

199,00€

CHIAVI DI MANOVRA

ASTA SCORREVOLE

ASTA SCORREVOLE



FG 621H/S8C

FG 621TX/S13

CHIAVI A T MASCHIO ESAGONALI
CON ASTA SCORREVOLE

CONTENUTO: 2,2.5,3,4,5,6,8,10mm

~~126,00€~~ **75,00€**

CHIAVI A T MASCHIO TORX

CONTENUTO: 6,7,8,9,10,15, 20,25,27,
30,40, 45,50 TX

~~199,80€~~ **119,00€**

ASTA FISSA

SERIE INDUSTRIA



FG 622H/S6

SET CHIAVI A T MASCHIO ESAGONALE

CONTENUTO: 2.5, 3, 4, 5, 6, 8mm

~~132,00€~~ **79,90€**

FG 622H/S7

SET CHIAVI A T MASCHIO ESAGONALE

CONTENUTO: 2.5, 3, 4, 5, 6, 8, 10mm

~~170,00€~~ **104,00€**

CHIAVE COMBINATA A CRICCO
REVERSIBILE CON ANELLO DI TENUTA

ANELLO IN ACCIAIO INTEGRATO CHE
CONSENTE LA TENUTA DEL BULLONE

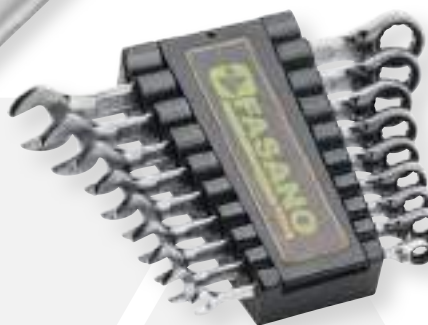

FG 605/ST9-B

SET CHIAVI A CRICCO REVERSIBILI
CON SUPPORTO IN ABS

CONTENUTO: 8,10,11,12,13,14,15,17,19mm

~~145,00€~~ **89,00€**

FG 605/ST11-B

SET CHIAVI A CRICCO REVERSIBILI
CON SUPPORTO IN ABS

CONTENUTO: 8,9,10,11,12,13,14,15,16,17,19mm

~~180,00€~~ **109,00€**

LEVA DI INVERSIONE A FILO TESTA E CON
LINGUETTA INCLINATA VERSO IL BASSO PER
UN MAGGIORE SPAZIO DI MANOVRA





FG 606/SP9

SET 9 CHIAVI COMBinate A CRICCO NON REVERSIBILE IN ROTOLO DI NYLON

CONTENUTO: 8,10,11,12,13,14,15,17,19 mm

~~105,00€~~ **62,50€**



FG 610FL/SP9

SET 9 CHIAVI COMBinate A CRICCO FLESSIBILI IN ROTOLO DI NYLON

CONTENUTO: 8, 10, 12, 13, 15, 16, 17, 18, 19 mm

~~186,00€~~ **112,50€**



FG 615A/S6

SET 6 CHIAVI DOPPIE CON CRICCO REVERSIBILE UNIVERSALE A 90 DENTI

CONTENUTO: 8x9, 10x11, 12x13, 14x15, 16x18, 17x19mm

~~118,00€~~ **69,00€**



FG 617B/S5

SET 5 CHIAVI A DOPPIO CRICCO FLESSIBILE UNIVERSALE

CONTENUTO: 8x10, 12x14, 13x15, 16x18, 17x19mm

~~108,00€~~ **64,90€**



FG 620A/S5

SET 5 CHIAVI A TESTA FLESSIBILE E CRICCO UNIVERSALE

CONTENUTO: 8, 10, 13, 14, 17mm

~~75,00€~~ **45,00€**



FG 622A/S6

SET 6 CHIAVI A CRICCO UNIVERSALE SERIE EXTRA-LUNGA

CONTENUTO: 8x9, 10x11, 12x13, 14x15, 16x18, 17x19 mm

~~120,00€~~ **72,00€**



FG 622A/S2

SET 2 CHIAVI A CRICCO UNIVERSALE SERIE EXTRA-LUNGA

CONTENUTO: 21x22, 24x27 mm

~~75,00€~~ **45,00€**

CHIAVI A BUSSOLA

1/4"



FG 624/CR14

CRICCHETTO REVERSIBILE DA 1/4"

- Sistema di inversione a ghiera integrato sulla testa
- Meccanismo a 72 denti
- Cromatura lucida
- Asola di aggancio

~~32,50€~~

19,90€



FG 624/FR14

CRICCHETTO REVERSIBILE DA 1/4"

- Modello con testa chiusa anti polvere
- Leva di inversione integrata a filo testa
- Corpo scavato di 13° per consentire l'utilizzo anche in spazi particolarmente difficoltosi
- Meccanismo a 72 denti
- Cromatura lucida e asola di aggancio

~~35,00€~~

21,50€



FG 624/RT14

CRICCHETTO REVERSIBILE DA 1/4"

- Sistema di avanzamento rotativo integrato nell'impugnatura
- Meccanismo a 60 denti
- Cromatura lucida e asola di aggancio

~~50,00€~~

29,90€

FG 624/MCR

MINI-CRICCHETTO CON ATTACCO QUADRO 1/4" A 72 DENTI



~~30,00€~~

17,90€

FG 624/MCH

MINI-CRICCHETTO CON ATTACCO ESAGONALE PER INSERTI 1/4"



~~30,00€~~

17,90€

FG 624/S12

SET 11 CHIAVI A BUSSOLA ESAGONALI E CRICCHETTO SU SUPPORTO IN PLASTICA

CONTENUTO: 4, 5, 6, 7, 8, 9, 10, 11, 12, 13, 14 mm FG 624/CR14



~~74,00€~~

45,00€



FG 147H/S8

SET 8 INSERTI A BUSSOLA 1/4" PER VITI CON IMPRONTA ESAGONALE

CONTENUTO: 2,5, 3,4,5,6,7,8,10

~~52,00€~~

29,90€

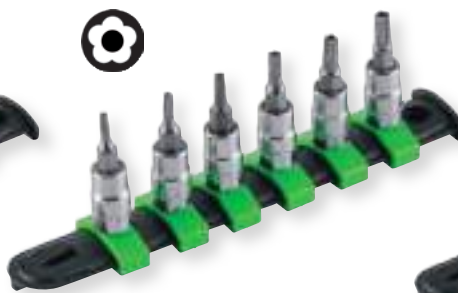

FG 147PT/S6

SET 6 INSERTI A BUSSOLA PENTALOMBATI DA 1/4"

CONTENUTO: PT10, 15, 20, 25, 27, 30

~~58,00€~~

34,90€



FG 147TX/S8

SET 8 INSERTI A BUSSOLA DA 1/4" TORX

CONTENUTO: TX9-TX40

~~65,00€~~

37,90€

~~72,00€~~ 39,90€



FG 624/S25

SET 25 UTENSILI CON ATTACCO QUADRO 1/4"



FG 624/E: 6, 8,10,11,12,13mm



FG 624/CR14



FG 89/38PI1 (1/4x1/4)



FG 85/25PH1, PH2, PH3



FG 85/25PZ1, PZ2, PZ3



FG 85/25F4, F5, F6, F7



FG 85/25TX10, TX15, TX20, TX25, TX30, TX40

~~110,00€~~ 59,90€



FG 624/S18

SET 18 UTENSILI CON ATTACCO QUADRO 1/4"



FG 624/E4,5,6,7,8,9,10,11,12,13,14mm



FG 624/CR14



FG 624/ES14

FG 624/PA50, 100

FG 624/PRF150



FG 624/GR14C



FG 624/SN14

~~170,00€~~ 99,00€



FG 624/S45

SET 45 UTENSILI DA 1/4"



FG 624/E4,5,6,7,8,9,10,11,12,13,14mm



FG 624/CR14



FG 624/PA50, 100

FG 624/PRF150

FG 624/ES14

FG 624/SN14



FG 624/GR14C



FG 148/H1.5-H10 / FG 148/TX8-TX40

FG 148/PH1-PH4 / FG 148/F1-F5

CHIAVI A BUSSOLA

3/8"

~~220,00€~~

135,00€



FG 624B/S80

SET 80 UTENSILI DA 3/8"



FG 624/B8,9,10,11,12,13,14,
15,16,17,18,19,21,22,23

FG 624B/L8,10,13,17,19



FG 624/CR38



FG 624/SN38



FG 149/H3,4,5,6,7,8, 10

FG 149/TX9,10,15,20,25,27,30,40



FG 624/ES38



FG 624B/PA75,125,150,250



FG 600/B8,10,13,15,17,19



FG 89/50PI2 3/8"x1/4"



FG 85/S31

FG 624B/S16

~~140,00€~~

79,90€

SET 15 CHIAVI A BUSSOLA
ESAGONALI 3/8" E CRICCHETTO

CONTENUTO: 8, 9, 10, 11, 12, 13,
14, 15, 16, 17, 18, 19, 21, 22, 23mm
FG 624/CR38



FG 624/CR38

CRICCHETTO
REVERSIBILE DA 3/8"-
MECCANISMO 72 DENTI



~~35,00€~~

19,90€

FG 624B/TXS10

SET 10 CHIAVI A BUSSOLA
EXTRA-LUNGHE CON
IMPRONTA TORX

CONTENUTO: E6, E7, E8, E10,
E11, E12, E14, E16, E18, E20



~~125,00€~~

69,90€

3/8"

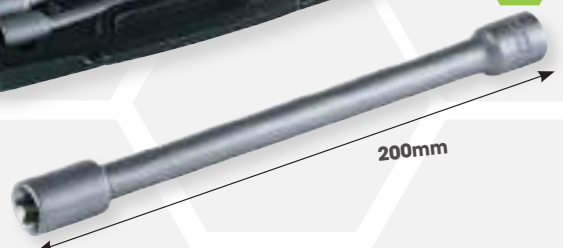

200mm

1/2"



~~130,00€~~

79,90€

FG 625/S27

SET 27 UTENSILI DA 1/2"



FG 625/A8,9,10,11,12,13,14,15,16,17,
18,19,20,21,22,23,24,25,26,27,30,32



FG 625/CR12



FG 625/SN12



FG 625/ES12



FG 625/PA125, 250



1/4"

1/2"



~~265,00€~~

159,00€

FG 625/S109

SET 109 UTENSILI DA 1/4" 1/2"



FG625/A8,9,10,11,12,13,14,15,16,17,
18,19,20,21,22,23,24,25,26,27,30,32



FG 624/E4,5,6,7,8,9,10,11,12,13,14



FG 624E/L4,5,6,7,8,9,10,11,12,13,14



FG 147/H2.5,3,4,5,6,7,8,10



FG 147/TX9,10,15,20,25,27,30,40



FG 624/CR14

FG 625/CR12



FG 625/SN12

FG 624/SN14



FG 625/ES12

FG 624/ES14



FG 624/GR14C



FG 625/PA125, 250

FG 624/PA50



FG 89/38PI1 1/4"x1/4"



FG 92/PM1



FG 600/B8,10,13,15,17,19

FG 85/25PH1, PH2, PH3, PZ1, PZ2, PZ3
FG 85/25SL3, SL4, SL4.5, SL5, SL5.5, SL6, L6.5
85/H1.5, H2, 2.5, H3, H4, H5, H6
FG 85/25TX9 - TX40, FG 88/60PI2



CHIAVI A BUSSOLA

1/4"

1/2"

FG BEST 108

SET 108 UTENSILI DA 1/4" 1/2"

~~250,00€~~

119,00€



FG BEST 108



FG 625/A10,11,12,13,14,15,16,
17,18,19,20,21,22,23,24,27,30,32



FG 624/E4,4.5,5,5.5,6,7,8,9,10,11,12,13,14



FG 625L/A14,15,17,19,22



FG 624E/L6,7,8,9,10,11,12,13



FG 625/TX10,11,12,14,16,18,20,24



FG 624/TX4,5,6,7,8



FG 87/AD

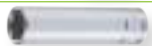

FG 181/B16,21 x CANDELE ACCENSIONE



FG 624/CR14
FG 625/CR12



FG 625/SN12
FG 624/SN14



FG 625/ES12
FG 624/ES14



FG 624/GR14



FG 625/PR125
FG 624/PR50,100



FG 139/D1.5,2,2.5



FG 147/PH1,PH2
FG 147/PZ1,PZ2
FG 147/SL4,SL5,5.SL6.5
FG 147/H3,H4,H5,H6
FG 147/TX10,TX15,TX20,TX25,TX30



FG 85/PH3,PH4
FG 85/PZ3,PZ4
FG 85/SL8,SL10,SL12
FG 85/H7,H8,H10,H12,H14
FG 85/TX40,TX45,TX50,TX55,TX60



1/4"

3/8"

1/2"



FG BEST 171

SET 171 UTENSILI DA 1/4", 3/8" E 1/2"

~~350,00€~~

159,00€

FG BEST 171



FG 625/A10,11,12,13,14,15,16,
17,18,19,20,21,22,23,24,27,30,32



FG 624/B10,11,12,13,14,15,16,17,18,19



FG 624/E4,4.5,5.5,6,7,8,9,10,11,12,13,14

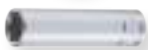

FG 625L/A16,17,18,19,22
FG 624B/L10,11,12,13,14,15
FG 624/4,5,6,7,8,9,10



FG 625/TX20,24
FG 624B/TX10,11,12,14,16,18
FG 624/TX4,5,6,7,8



FG 181/B16,21 x CANDELE ACCENSIONE



FG 87/AD

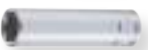

FG 181/B16,21 x CANDELE ACCENSIONE



FG 624/CR14
FG 624/CR38
FG 625/CR12



FG 625/SN12
FG 624/CR38
FG 624/SN14



FG 625/ES12
FG 624/ES14



FG 624/GR14



FG 625/PR125
FG 624B/PR125
FG 624/PR50,PR100



FG 139/D1,1.5,2,2.5,3,4,4.5,5



FG 147/PH0,PH1,PH2
FG 147/PZ0,PZ1,PZ2
FG 147/SL4,5.5,6.5,7
FG 147/H3,H4,H5
FG 147/TX8-TX30
FG 147/RTX8-RTX30



FG 85/PH3,PH4
FG 85/PZ3,PZ4
FG 85/SL8,SL10,SL12
FG 85/H7,H8,H10,H12,H14
FG 85/TX40-TX50
FG 85/TT10-TT45
FG 85/M5-M9





CHIAVI A BUSSOLA

1/4"

1/2"



FG 625/S110

SET 110 UTENSILI DA 1/4" 1/2"

~~398,80€~~

239,00€



FG 625/A8,9,10,11,12,13,14,15,16,17,
18,19,20,21,22,23,24,25,26,27,30,32



FG 624/E4,5,6,7,8,9,10,11,12,13,14



FG 624/CR14
FG 625/CR12



FG 625/SN12
FG 624/SN14



FG 625/ES12
FG 624/ES14



FG 624/GR14C



FG 625/PA125, 250
FG 624/PA50, 100



FG 89/38PI1 1/4"x1/4"



FG 85/25PH1, PH2, PH3
FG 85/25SL3, SL4, SL4.5, SL5, SL5.5, SL6, L6.5
FG 85/25PZ1, PZ2, PZ3
FG 85/H1.5, H2, 2.5, H3, H4, H5, H6
FG 85/25T9, T10, T15, T20, T25, T27, T30, T40
FG 88/60PI2



FG 139/B



FG 48/L



FG 49



FG 600/B8,10,11,12,13,14,15,17,19



FG 22/3x75, 4x100, 5.5x100
FG 22/PH0x60, PH1x80, PH2x100



FG 59SR/160
FG 63SR/160



FG 58/B240



FG 132/H500



FG 79/SP

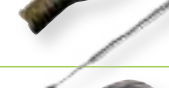

FG 92/PM1



FG 44/MT5

FG 625TX/S9

SET 9 CHIAVI A BUSSOLA DA 1/2" TORX

CONTENUTO: E8, E10, E12, E14, E16, E18, E20, E22, E24



~~68,00€~~ 39,90€

FG 625LTX/S9

SET 9 CHIAVI A BUSSOLA 1/2" TORX

CONTENUTO: 8, 10, 12, 14, 16, 18, 20, 22, 24 E



~~115,00€~~ 69,90€

FG 625TX/S13

SET 13 CHIAVI A BUSSOLA SNODATE CON IMPRONTA TORX

1/4": E4,E5,E6,E7,E8
3/8": E10,E12,E14,E16
1/2": E18,E20,E22,E24



~~150,00€~~ 89,90€

FG 150TX/S11

SET 11 INSERTI A BUSSOLA TORX 1/2"

CONTENUTO: TX10, TX15, TX20, TX25, TX27, TX30, TX40, TX45, TX50, TX55, TX60



~~145,00€~~ 85,00€

FG 625TX/S23

SET CHIAVI A BUSSOLA TX E INSERTI A BUSSOLA TX

~~200,00€~~ 99,00€



FG 624/TX4, TX5, TX6, TX7, TX8, TX10



FG 625/TX12, TX14, TX16, TX18, TX20, TX22, TX24



FG 150/TX10, TX15, TX20, TX25, TX27, TX30, TX40



FG 625/CR12

FG 625/PA125



CHIAVI A BUSSOLA



FG 150TX/S32

SET 32 INSERTI A BUSSOLA TORX DA 1/2"

~~166,80€~~ **99,00€**



FG 150/TX20 - TX70



FG 150L/TX20 - TX70



FG 150XL/TX40 - TX70



FG 150XXL/TX40 - TX70



FG 150M/S26

SET 26 INSERTI A BUSSOLA XZN DA 1/2"

~~160,80€~~ **99,00€**



FG 150/M5 - M16



FG 150L/M5 - M16



FG 150XL/M5 - M14



FG 150XXL/M8 - M14



FG 150H/S30

SET 30 INSERTI A BUSSOLA ESAGONALI DA 1/2"

~~180,80€~~ **109,00€**



FG 150/H5 - H19



FG 150L/H5 - H13



FG 150XL/H5 - H14

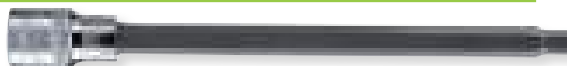

FG 150XXL/H5 - H12

FG 625/CR12

CRICCHETTO REVERSIBILE DA 1/2"
- MECCANISMO 72 DENTI



~~42,00€~~ 24,90€

FG 625/RT12

CRICCHETTO REVERSIBILE
DA 1/2" CON IMPUGNATURA
ROTANTE - 60 DENTI



~~65,00€~~ 39,00€

1/2"



FG 625/FR12

CRICCHETTO REVERSIBILE DA 1/2"

- Modello con testa chiusa anti polvere
- Leva di inversione integrata a filo testa
- Corpo scavato di 13° per consentire l'utilizzo anche in spazi particolarmente difficoltosi
- Meccanismo a 72 denti
- Cromatura lucida
- Asola di aggancio

~~49,00€~~ 29,90€

3/4"



FG 629A/S15

SET BUSSOLE ESAGONALI
DA 3/4" + ACCESSORI

~~490,00€~~ 289,00€



19,22,23,27,30,32
36,41,46,50, 60mm



FG 629/CR34



FG 629/SN34

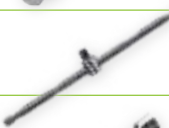

FG 629/ES34



FG 629/PR200

FG 629B/S15

SET BUSSOLE POLIGONALI
DA 3/4" + ACCESSORI

~~490,00€~~ 289,00€

FG 628/S10

SET 10 CHIAVI A BUSSOLA RINFORZATE
DA 1/2" SU SUPPORTO IN PLASTICA

CONTENUTO: 10, 11, 12, 13, 15, 16, 17, 18, 19, 21 mm

~~85,00€~~ 49,90€



FG 152RH/S9

~~108,00€~~ 65,00€

CONTENUTO: 5-19mm

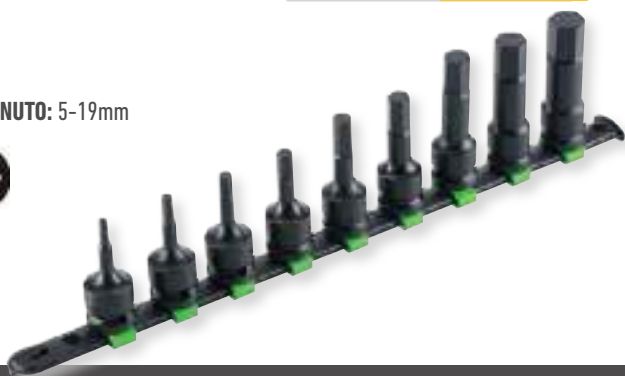

FG 152/RTXS10

~~150,00€~~ 89,00€

SET 10 INSERTI A BUSSOLA
RINFORZATI TORX DA 1/2"

CONTENUTO: TX20-TX70





GIRAVITI E PINZE

FG 22/S6

CONTENUTO: 3x75, 4x100, 5.5x100,
PH0x60, PH1x80, PH2x100



~~29,58€~~

17,90€

FG 22/S8

CONTENUTO: 3x75, 4x100, 5.5x100, 6.5x30
PH0x60, PH1x80, PH2x100, PH2x30



~~39,00€~~

23,90€

FG 22/S8B

CONTENUTO: 2.5x75, 3.5x100,
4x100, 6.5x150, 8x150, PH0x60,
PH1x80, PH2x150



~~42,00€~~

25,90€

FG 22/S10

CONTENUTO: 2.5x60, 3x75, 4x100,
5.5x150, 6.5x150, 4x30 PH0x60, PH1x80,
PH2x100, PH1x30



~~55,00€~~

32,90€

FG 22/S12

CONTENUTO: 2.5x60, 3x75, 4x100, 5.5x150,
6.5x150, 8x150, 4x30, PH0x60, PH1x80,
PH2x100, PH3x150, PH1x30



~~76,50€~~

45,90€

FG 22TX/S6

CONTENUTO: TX10, TX15, TX20, TX25, TX27,
TX30



~~56,00€~~

33,50€



FG 139/B
SET 10 CHIAVI MASCHIO A L ESAGONALI - SERIE CORTA
 1,5,2,2,5,3,4,5,5,6,8,10mm

~~13,50€~~ **7,90€**

FG 139/C
SET 10 CHIAVI MASCHIO A L ESAGONALI - SERIE LUNGA
 1,5,2,2,5,3,4,5,6,8,10mm

~~20,00€~~ **10,90€**



FG 139/D
SET 10 CHIAVI MASCHIO A L ESAGONALI - SERIE CORTA
 1,5,2,2,5,3,4,5,5,6,8,10mm

~~18,00€~~ **9,90€**

FG 139/E
SET 10 CHIAVI MASCHIO A L ESAGONALI - SERIE LUNGA
 1,5,2,2,5,3,4,5,6,8,10mm

~~28,00€~~ **16,90€**



FG 139
SET 12 CHIAVI MASCHIO A L ESAGONALI - SERIE SFERICA
 1,5,2,2,5,3,4,4,5,5,5,6,7,8,10mm

~~29,00€~~ **16,90€**

FG 139/L
SET 12 CHIAVI MASCHIO A L ESAGONALI - SERIE LUNGA
 1,5,2,2,5,3,4,4,5,5,5,6,7,8,10mm

~~33,00€~~ **19,90€**



FG 139/S9
SET 9 CHIAVI MASCHIO A L ESAGONALI E LATO CORTO 110°
 CONTENUTO: 1,5 - 10,0mm

~~32,00€~~ **19,90€**



FG 138/BP
SET 9 CHIAVI MASCHIO TORX A L E TESTA SFERICA
 CONTENUTO:
 TX8,10,15,20,25,27,30,40,50

~~50,00€~~ **29,90€**

TESTA SFERICA



FG 138
SET 12 CHIAVI MASCHIO TORX A L
 CONTENUTO:
 TX7,X8, 9, 10,15,20,25,27,30,40,45, 50

~~46,00€~~ **27,90€**



GIRAVITI E PINZE

FG 139/LM

SET 10 CHIAVI MASCHIO A L
ESAGONALI - SERIE LUNGA
CONTENUTO: 1.5, 2, 2.5, 3, 4, 5, 6,
7, 8, 10mm

~~43,00€~~ **25,90€**

ESTREMITÀ
MAGNETICA



FG 138/M

SERIE 10 CHIAVI MASCHIO
A L TORX
CONTENUTO: TX9 - TX50

~~52,50€~~ **31,90€**

ESTREMITÀ
MAGNETICA



FG 142/S9

SET 9 CHIAVI MASCHIO
CON IMPUGNATURA E
IMPRONTA ESAGONALE

CONTENUTO: 2, 2.5, 3, 4, 5, 6, 7,
8, 10 mm

~~107,00€~~ **59,90€**



FG 143TX/S6

SET CHIAVI MASCHIO
CON IMPUGNATURA E
IMPRONTA TORX

CONTENUTO: TX10, TX15,
TX20, TX25, TX30, TX40

~~67,00€~~ **39,90€**



FG 86/S56

SET 56 UTENSILI ASSORTITI



~~150,00€~~ **90,00€**

FG 58/A240

PINZA REGOLABILE
A CERNIERA CHIUSA CON
PULSANTE DI SGANCIO RAPIDO

L: 240mm - 9.5"



~~36,00€~~ **19,90€**



FG 59SR/S3

SET 3 PINZE, DOTATE DI MOLLA SOFT-RUN

FG 59SR/160, FG 61SR/160, FG 63SR/160

~~70,00€~~ **41,90€**



FG 59PV/S3

SET 3 PINZE, CON MANICI IN DOPIO STRATO DI PVC

FG 59PV/160, FG 61PV/160, FG 63PV/160

~~60,00€~~ **35,90€**



FG 51/S4

SET 4 PINZE PER ANELLI ELASTICI 8-25MM

~~81,00€~~ **48,50€**

FG 51/S4B

SET 4 PINZE PER ANELLI ELASTICI 19-60MM

~~87,00€~~ **52,50€**



"INSERTI RINFORZATI PER ANELLI DI GRANDE TENUTA"



FG 55/S4

SET 4 PINZE PER ANELLI ELASTICI CON INSERTI RINFORZATI IN ACCIAIO 10-25MM

~~118,00€~~ **69,50€**

FG 55/S4B

SET 4 PINZE PER ANELLI ELASTICI CON INSERTI RINFORZATI IN ACCIAIO 19-60MM

~~122,00€~~ **72,50€**





FG 603/S28A

FG 603/S28B

**KIT 26 UTENSILI ISOLATI, COMPLETO DI
ELMETTO DIELETTRICO E
GUANTI DIELETTRICI 1.000V**



**IDEALE PER INTERVENTI SU
VEICOLI ELETTRICI ED IBRIDI**

| CODICE | TAGLIA GUANTI | LISTINO | €/PROMO |
|-------------|---------------|---------|---------------|
| FG 603/S28A | TAGLIA 9 | 878,00 | 439,00 |
| FG 603/S28B | TAGLIA 10 | 878,00 | 439,00 |



FG 59/IS200



FG 61/IS200



FG 63/IS160



FG 603/E10,11,12,
13,14,17,19



FG 625E/10,11,12,
13,14,17,19



FG 22E/4X100, 5.5X125,
FG22E/PH1X80, PH2X100



FG 625E/CR12



FG 625E/PR250



FG 49/E



FG 48/IS



FG 22/CF250

FG 603/TA1

TAPPETO ISOLANTE 1000V
- 1.000x1.000x4mm

~~240,00€~~

129,00€



FG 22E/S6

SET 6 GIRAVITI ISOLATI

CONTENUTO: 3x100, 4x100, 5.5x125, PH0x60, PH1x80, PH2x100



~~48,90€~~

29,90€

FG 22E/SZ6

SET 6 GIRAVITI ISOLATI

CONTENUTO: 3x100, 4x100, 5.5x125 PZ0x60, PZ1x80, PZ2x100



~~48,90€~~

29,90€



FG 59IS/S3

SET 3 PINZE CON MANICI ISOLATI

~~102,80€~~

56,90€



FG 68U/S439

SET PINZA UNIVERSALE + 3 MATRICI E 436 CAPICORDA ISOLATI

~~260,80€~~

159,00€



FG 96/DG

MULTIMETRO DIGITALE DC/AC - OHM

~~165,00€~~

99,00€

FUNZIONI AGGIUNTIVE:

- MISURAZIONE TEMPERATURA
- MISURAZIONE DI UMIDITÀ
- MISURAZIONE LUX
- MISURAZIONE DEL SUONO



FUNZIONE

| | |
|--------------------------------|--|
| DC | 0.4 V , 4 V , 40 V , 400 V , 600V (± 0.7%) |
| AC | 4 V , 40 V , 400 V , 600V (± 0.8%) |
| Ω | 400 Ω , 4K Ω , 400kΩ , 4MΩ (± 1.2) 40MΩ (± 2.0%) |
| CAPACITA' | 4nF , 40nF , 400nF , 4μF , 40 μF , 200 μF (± 3.0%) |
| FREQUENZA | 10Hz , 100Hz , 1kHz , 10kHz , 100kHz (± 2.0%) |
| DUTY CYCLE | 0.1% - 99.9% (± 3.0%) |
| TEST DI CONTINUITA' | si/si/yes |
| PROVA DIODI | si/si/yes |
| TEMPERATURA | -20°C - 400°C (± 3.0% / 0.1°C) -20°C - 1.000°C (± 3.0% / 1°C) |
| CAPACITA' RILEVAZIONE UMIDITA' | 30% - 95% RH ((± 5.0%) |
| LUX | 4.000 Lux / 40.000 Lux ((± 5.0%) |
| CAPACITA' RILEVAZIONE SUONO | 35 - 100dB ((± 4dB) |
| STANDBY | Dopo 15 minuti |
| INDICATORE LIVELLO BATTERIA | Si |
| BATTERIA | 9V |
| DIMENSIONE | 8x3.5x16.5H mm |

CHIAVI DINAMOMETRICHE PER SERRAGGI DESTROSI

PRECISIONE DI SERRAGGIO: $\pm 4\%$

IMPUGNATURA ERGONOMICA IN POLIPROPILENE SOFT-TOUCH

QUADRANTE CON DOPPIA SCALA NM E LBS CON NUMERI DI FACILE LETTURA

SISTEMA DI REGOLAZIONE CONTROLLATO CON AVVICINAMENTO SOFT

SISTEMA DI INVERSIONE A GHIERA INTEGRATO SULLA TESTA

CROMATURA LUCIDA

MECCANISMO INTERNO INTERAMENTE IN ACCIAIO DOTATO DI CUSCINETTO A SFERE

MECCANISMO A 72 DENTI CON 5° DI RIPRESA



CHIAVI DINAMOMETRICHE A DISINNESTO E ATTACCO QUADRO

| CODICE | RISOLUZIONE | NM | LISTINO | €/PROMO | |
|----------|-------------|----------|---------|---------|------|
| FG 531 | 0.1Nm | 5-25Nm | 175,00 | 99,00 | 1/4" |
| FG 533/2 | 0.25Nm | 10-50Nm | 189,00 | 112,50 | 3/8" |
| FG 536/1 | 0.5Nm | 20-100Nm | 195,00 | 116,00 | 1/2" |
| FG 536/2 | 1.0Nm | 40-200Nm | 216,00 | 119,00 | 1/2" |
| FG 536/3 | 2.0Nm | 60-340Nm | 225,00 | 135,00 | 1/2" |



CHIAVI DINAMOMETRICHE DIGITALI PER NM E GRADI

1/2"

| CODICE | NM | LISTINO | €/PROMO |
|------------|----------|---------|---------|
| FG 543/DG1 | 16.8-135 | 580,00 | 349,00 |
| FG 543/DG2 | 10-200 | 610,00 | 365,00 |

- Doppia modalità di misurazione: PICCO e TRACCIA
- Indicatore sonoro e visivo a 12 led al raggiungimento della coppia prefissata
- Possibilità di memorizzare fino a 250 differenti serraggi grazie al software PC incluso nel kit Interfaccia PC tramite presa USB
- Possibilità di impostare fino a 9 serraggi predefiniti
- Alimentazione: 2 batterie 1.5V (incluse)





**CHIAVE DINAMOMETRICA
AD INNESTO FEMMINA 9X12MM**

| CODICE | NM | RES | L/MM | LISTINO | €/PROMO |
|----------|--------|------|------|---------|---------|
| FG 544/1 | 5-25 | 1.0 | 259 | 230,00 | 139,00 |
| FG 544/2 | 10-50 | 0.25 | 385 | 195,00 | 119,00 |
| FG 544/3 | 20-100 | 0.5 | 385 | 210,00 | 129,00 |

**CHIAVE DINAMOMETRICA
AD INNESTO FEMMINA 14X18MM**

Precisione: ± 3%

| CODICE | NM | RES | L/MM | LISTINO | €/PROMO |
|----------|--------|-----|------|---------|---------|
| FG 544/4 | 40-200 | 1.0 | 480 | 250,00 | 149,00 |



FG 547/DG

**GONIOMETRO DIGITALE
PER SERRAGGI ANGOLARI**

Precisione di serraggio: ± 2%



| CODICE | GRADI | A/MM | H/MM | LISTINO | €/PROMO |
|-----------|-------|------|------|---------|---------|
| FG 547/DG | 1-360 | 58 | 41 | 160,00 | 92,50 |

FG 580/A

**MINI MOLTIPLICATORE DI
COPPIA DESTORSO/SINISTRORSO**

1/2"x1/2" Rapporto: 3.4:1

~~250,00€~~ **149,00€**



FG 580/B

**MINI MOLTIPLICATORE DI
COPPIA DESTORSO/SINISTRORSO**

1/2"x3/4" Rapporto: 3.4:1

~~340,00€~~ **199,00€**

**BARRE DINAMOMETRICHE A
DISINNESTO E ATTACCO QUADRO**

| CODICE | NM | LISTINO | €/PROMO |
|----------|------|-----------|---------|
| FG 538/1 | 3/4" | 140-560 | 399,00 |
| FG 538/2 | 3/4" | 200-800 | 449,00 |
| FG 539/1 | 1" | 200-1.000 | 579,00 |

GRADO DI PRECISIONE: ± 4%



FORNITA IN CASSETTA DI ABS



MANUTENZIONE GENERALE



FG 70/S110

**SET MASCHI E FILIERE IN ACCIAIO
AL CROMO + ACCESSORI - 110PZ**
PASSO GROSSO E FINE - FILETTATURA METRICA

~~300,00€~~

179,00€

ACCESSORI

| | | | | | | |
|---------|---------|---------|---------|---------|---------|--------|
| 2x.04 | 6x0.75 | 12x1 | 2x0.4 | 6x0.75 | 12x1 | GF25x9 |
| 3x0.5 | 7x0.75 | 12x1.25 | 3x0.5 | 7x0.75 | 12x1.25 | GF8x14 |
| 4x0.7 | 8x0.75 | 12x1.5 | 4x0.7 | 8x0.75 | 12x1.5 | GMM1.5 |
| 5x0.8 | 8x1 | 14x1 | 5x0.8 | 8x1 | 14x1 | GMM3 |
| 6x1 | 9x0.75 | 14x1.25 | 6x1 | 9x0.75 | 14x1.25 | GMC1 |
| 7x1 | 9x1 | 14x1.5 | 7x1 | 9x1 | 14x1.5 | |
| 8x1.25 | 10x0.75 | 16x1 | 8x1.25 | 10x0.75 | 16x1 | |
| 9x1.25 | 10x1 | 16x1.5 | 9x1.25 | 10x1 | 16x1.5 | |
| 10x1.5 | 10x1.25 | 18x1.5 | 10x1.5 | 10x1.25 | 18x1.5 | |
| 11x1.5 | 11x0.75 | | 11x1.5 | 11x0.75 | | |
| 12x1.75 | 11x1 | | 12x1.75 | 11x1 | | |
| 14x2 | 11x1.25 | | 14x2 | 11x1.25 | | |
| 16x2 | 12x0.75 | | 16x2 | 12x0.75 | | |



FG 75HSS/S25

**SET 25 PUNTE ELICOIDALI
CILINDRICHE IN ACCIAIO
HSS RETTIFICATE**
1 - 13 X0,5MM

~~122,00€~~

69,00€



FG 75TIN/S25

**SET 25 PUNTE ELICOIDALI
CILINDRICHE IN ACCIAIO
HSS -TIN 5% RETTIFICATE**
1 - 13 X0,5MM

~~169,00€~~

99,00€



FG 75CO/S25

**SET 25 PUNTE ELICOIDALI
CILINDRICHE IN ACCIAIO
HSS-COBALTO 5% RETTIFICATE**
1 - 13 X0,5MM

~~205,00€~~

119,00€



FG 78HSS/S12

**SET 9 FRESE A TAZZA
IN ACCIAIO HSS BI-METAL
+ ACCESSORI**

~~200,00€~~

119,00€

FG 48/L

CUTTER PROFESSIONALE
A LAMA LUNGA



~~8,00€~~ 4,90€

FG 48/LG

CUTTER PROFESSIONALE
A LAMA LUNGA



~~8,00€~~ 4,90€

FG 48/L9 **NEW**

CUTTER EXTRA PIATTO CON LAMA
A SETTORI 9MM

- CORPO IN ACCIAIO INOX
- FORNITO CON UNA LAMA



~~6,50€~~ 3,90€

FG 48/B

CUTTER A SERRAMANICO
CON LAMA TRAPEZOIDALE

- CON 3 LAME DI RICAMBIO



~~19,80€~~ 11,50€

FG 49/TC

FORBICE DA ELETTRICISTA,
DOTATA DI INCAVO SPELLAFILI
E CORPO INTEGRALMENTE IN ACCIAIO

- L/MM 140 - A/MM 65MM
- LAMA MICRODENTATA IN ACCIAIO
- HRC: 56
- STRUTTURA INTEGRALE IN ACCIAIO INOX
- TAGLIACAVI 12MM
- CON SUPPORTO PER CINTURA

~~33,50€~~ 19,90€

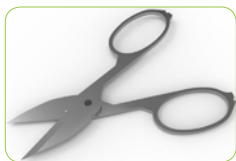

STRUTTURA INTERAMENTE
IN ACCIAIO FORGIATO

FG 49/TCX

FORBICE DA ELETTRICISTA, DOTATA
DI INCAVO SPELLAFILI E CORPO
INTEGRALMENTE IN ACCIAIO

- L/MM 160 - A/MM 50MM
- LAMA MICRODENTATA IN ACCIAIO
- HRC: 56
- STRUTTURA INTEGRALE IN ACCIAIO INOX
- TAGLIACAVI 15MM
- CON SUPPORTO PER CINTURA

~~42,80€~~ 25,50€



STRUTTURA INTERAMENTE
IN ACCIAIO FORGIATO

FG 77/PVC4

TRONCATUBI A CRICCO

- SISTEMA A CREMAGLIERA CON
AVANZAMENTO PROGRESSIVO
- DOTATA DI PIATTAFORMA IN NYLON CHE
FACILITA IL TAGLIO DI PROFILI PIATTI
- Ø: 0-42MM



TUBO IN PVC

~~65,00€~~ 39,00€

FG 49/MU

FORBICE MULTIUSO CON GOLA SPELLAFILI
E LAME IN ACCIAIO INOX ZIGRINATE

- L/MM 203 - LAMA 52MM - SPELLAFILI 1.0, 1.5, 2.0 MM²



HRC: 52-54

~~21,00€~~ 12,50€



MANUTENZIONE GENERALE

FG 127/S1

SET SCALPELLI E PUNZONI



~~40,00€~~

23,90€

FG 128/S11

SET 11 UTENSILI DA PERCUSSIONE CON IMPUGNATURA



~~108,50€~~

59,90€

FG 95/CA

CALIBRO A CORSOIO, LETTURA CINQUANTESIMALE

- L/MM: 150



~~42,00€~~

24,90€

FG 95/DG

CALIBRO A CORSOIO, DIGITALE

- L/MM: 150



~~76,00€~~

44,90€



FLESSOMETRO CON CASSA IN ABS ANTI-SHOCK E NASTRO IN ACCIAIO RIVESTITO IN NYLON CLASSE II

| CODICE | L/MM | BANDA | LISTINO | €/PROMO |
|------------|------|-------|---------|---------|
| FG 44/MT3 | 3 | 16MM | 9,00 | 5,50 |
| FG 44/MT5 | 5 | 25MM | 14,50 | 8,90 |
| FG 44/MT8 | 8 | 25MM | 20,50 | 12,50 |
| FG 44/MT10 | 10 | 25MM | 24,50 | 14,90 |

FG 97/T1

TERMOMETRO DIGITALE AD INFRAROSSI

RANGE DI MISURAZIONE

-32°C ~ 760°C / -25°F ~ 1.400°F

~~233,00€~~

139,00€



FG 97/T2

TERMOMETRO DIGITALE AD INFRAROSSI

RANGE DI MISURAZIONE

-32°C ~ 1.650°C / -25°F ~ 3.002°F

~~579,00€~~

249,00€

CE

FG 712/L4

NEW

PORTA MINUTERIE A RIPIANI GIREVOLI

- FORNITO CON DIVISORI INTERNI
- DOTATO DI 4 RIPIANI GIREVOLI E VASCHETTA SUPERIORE PORTA MINUTERIE
- MATERIALE: ABS RESISTENTE AGLI URTI
- DOTATO DI 4 PIEDI D'APPOGGIO



~~130,00€~~

79,00€

FG 92/PM4

PROLUNGA MAGNETICA
TELESCOPICA (165-622MM)

~~25,00€~~

11,90€



FG 92/PF

PROLUNGA MAGNETICA
CON ASTA FLESSIBILE

~~25,00€~~

11,90€

LUNGHEZZA
ASTA: 400MM



FG 92/PM

PROLUNGA MAGNETICA
CON ASTA FLESSIBILE

~~16,50€~~

9,90€

1 metro

ASTA
DA 1 METRO

Ø: 3.9mm



FG 93/M50

SPECCHIETTO TELESCOPICO
E ARTICOLATO IN ACCIAIO

~~27,80€~~

16,90€

50mm

FG 93/M95

SPECCHIETTO TELESCOPICO
E ARTICOLATO IN ACCIAIO

~~27,80€~~

16,90€

370-775mm

50x95mm

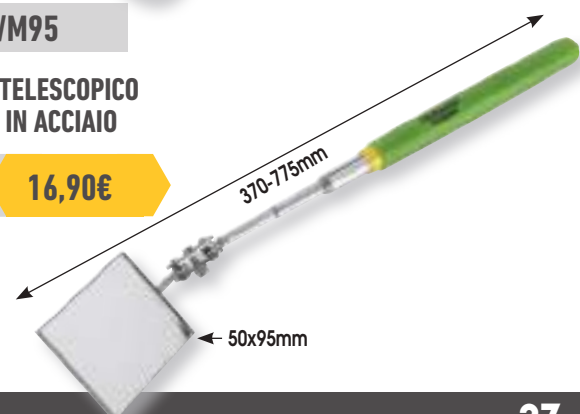



MANUTENZIONE GENERALE

FG 207

NEW



LAMPADA RICARICABILE A LED

~~60,00€~~

29,90€



TOP LED DI PUNTAMENTO



FG 206

NEW



LAMPADA RICARICABILE A LED

~~50,00€~~

25,90€



EXTRA-PIATTA



FG 208

NEW

LAMPADA SOTTO COFANO RICARICABILE A LED

LUNGHEZZA REGOLABILE:
1.300-2.060MM

LAMPADA PORTATILE
INTEGRATA E REMOVIBILE

DUE PRODOTTI IN 1



CORDLESS LAMP
200 LUMEN

DOTATA DI SISTEMA
MAGNETICO



~~240,00€~~

129,00€



FG 211

~~98,50€~~ **59,00€**

LAMPADA
RICARICABILE A LED

CE

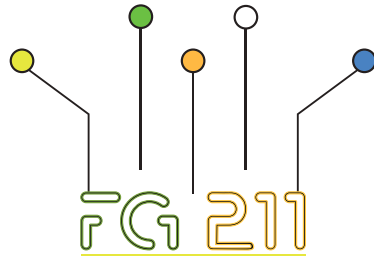

TOP LED DI
PUNTAMENTO



ORIENTABILITÀ
A 360°



REGOLATORE
D'INTENSITÀ



INDICATORE
DI CARICA



BASE MAGNETICA E
GANCIO ESTRAIBILE

FG 212

~~70,00€~~ **39,00€**

LAMPADA
RICARICABILE A LED

CE



FG 210/A

MINI FARETTO
PORTATILE A LED



~~75,00€~~ **49,00€**

CE





VALIGIE PORTA UTENSILI

CE



FG 98/GAS

SALDATORE PORTATILE A GAS

- TEMPERATURA MAX: 210-450°C
- 25 WATT
- CAPACITÀ: 120 MIN CONTINUATIVI
- FORNITO CON PUNTE PER SALDARE, TAGLIARE E SOFFIARE

~~105,00€~~

62,90€

CE



FG 98/LT

SALDATORE PORTATILE CON BATTERIA AL LITIO

- TEMPERATURA MAX: 600°C
- AUTONOMIA: 40MIN CONTINUATIVI
- TEMPO DI RICARICA: 3.5H
- FORNITO CON PUNTE PER SALDARE, TAGLIARE E SOFFIARE

~~245,00€~~

139,00€

FG 111/A

CASSETTA PORTA-UTENSILI A 3 SCOMPARTI

~~50,00€~~

29,90€

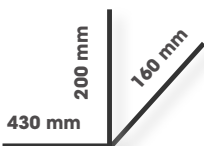

FG 111/B

CASSETTA PORTA-UTENSILI A 5 SCOMPARTI

~~60,00€~~

35,90€

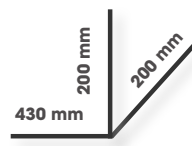

FG 111/C

CASSETTA PORTA-UTENSILI A 5 SCOMPARTI

~~72,00€~~

42,90€

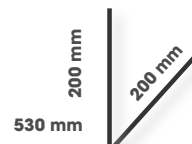

FG 111/AS55

NEW

CASSETTA PORTA-UTENSILI FG 111/C CON 5
SCOMPARTI CON ASSORTIMENTO 55 UTENSILI

~~570,00€~~

199,00€



PER IL CONTENUTO CONSULTARE
PAGINA 269 DEL CATALOGO GENERALE

FG 111/AS104

NEW

CASSETTA PORTA-UTENSILI FG 111/C CON 5
SCOMPARTI CON ASSORTIMENTO 104 UTENSILI

~~680,00€~~

299,00€



PER IL CONTENUTO CONSULTARE
PAGINA 269 DEL CATALOGO GENERALE



ESTRATTORI



FG 162/S3

SET 3 ESTRATTORI A 2 GRIFFE
- 27-90MM, 27-135MM, 35-155MM

~~285,00€~~ 169,00€



FG 163/S2B

ESTRATTORE A 3 GRIFFE PER PRESA ESTERNA + GRIFFE PER PRESA INTERNA
- APERTURA MAX PER PRESA ESTERNA: 7-140MM
- APERTURA MAX PER PRESA INTERNA: 50-70MM

~~230,00€~~ 129,00€



FG 165/...

ESTRATTORE AUTOCENTRANTE A 3 GRIFFE

- POSSIBILITÀ DI 4 POSIZIONI DIFFERENTI
- PRESA ESTERNA
- MECCANISMO AUTOCENTRANTE
- GRIFFE CON APERTURA PER CONSENTIRE UNA MIGLIOR PRESA SU BULLONI SPECIALI

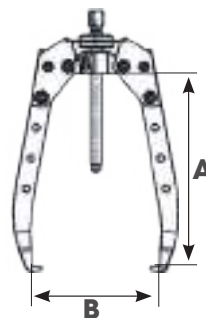

| CODICE | A/MM | B/MM | LISTINO | €/PROMO |
|----------|------|------|---------|---------|
| FG 165/1 | 120 | 125 | 250,00 | 153,50 |
| FG 165/2 | 210 | 220 | 320,00 | 189,00 |
| FG 165/3 | 270 | 280 | 470,00 | 279,00 |

FG 165/HI

ESTRATTORE IDRAULICO AUTOCENTRANTE A 3 GRIFFE

- POSSIBILITÀ DI 4 POSIZIONI DIFFERENTI
- PRESA ESTERNA
- MECCANISMO AUTOCENTRANTE
- GRIFFE CON APERTURA PER CONSENTIRE UNA MIGLIOR PRESA SU BULLONI SPECIALI

| CODICE | LISTINO | €/PROMO |
|-----------|---------|---------|
| FG 165/HI | 870,00 | 529,00 |

- A/MM: 270
- B/MM: 280
- C/MM: 4.5

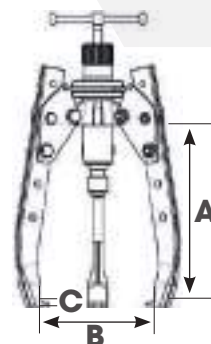



ESTRATTORE A 2/3 GRIFFE

- DOTATO DI 3 GRIFFE PER PRESA INTERNA E 3 GRIFFE PER PRESA ESTERNA
- GRIFFE IN ACCIAIO CROMO VANADIO

| CODICE | Ø INTERNAL | Ø ESTERNA | LISTINO | €/PROMO |
|------------|------------|-----------|---------|---------|
| FG 165/IE1 | 25-100MM | 0-75MM | 288,00 | 169,00 |
| FG 165/IE2 | 45-150MM | 40-130MM | 688,00 | 409,00 |



MASSA BATTENTE

| CODICE | L/MM | PESO | LISTINO | €/PROMO |
|------------|---------|------|---------|---------|
| FG 165/MB1 | 360 | 1KG | 158,00 | 89,00 |
| FG 165/MB2 | 200+400 | 2KG | 298,00 | 175,00 |



FG 168/FS5

SET 5 ESTRATTORI CONICI PER VITI E PRIGIONIERI SPEZZATI

~~16,50€~~ 9,90€



FG 168EP/S5

SET 5 ESTRATTORI CONICI PER VITI E PRIGIONIERI SPEZZATI
- INSERIMENTO A PERCUSSIONE

~~26,50€~~ 15,90€



FG 168/S25

SET ESTRATTORI PER VITI E PRIGIONIERI SPEZZATI

- DOTATO DI GUIDE PER INTERNO ED ESTERNO E PUNTE PER FORARE
- PER VITI/BULLONI CON DIAMETRO 6-16MM

~~120,00€~~ 72,50€



FG 182/S10

SET ESPANSORI A SETTORE PER INTERNI CON ACCESSORI

~~760,00€~~ 399,00€



FG 182/S14

SET ESTRATTORI PER CUSCINETTI CON FALSE SFERE

- ØMM: 5, 6, 8, 9, 11, 12,5

~~195,00€~~ 119,00€



UTENSILI PNEUMATICI



QUALITA'

GLI UTENSILI SONO PRODOTTI
DALLA SCELTA DEI MIGLIORI
MATERIALI DISPONIBILI



ASSISTENZA

SUPPORTO COSTANTE E MASSIMA
DISPONIBILITÀ NEI CONFRONTI
DEL CLIENTE



RICERCA

GRANDE CAPACITÀ NELL'ANTICIPARE
LE ESIGENZE DEL MERCATO

PNEUMATIC TOOLS

LA GAMMA DI UTENSILI PNEUMATICI FASANO TOOLS SI CARATTERIZZA
PER ELEVATE PRESTAZIONI E GRANDE AFFIDABILITÀ NEL TEMPO.

LA PROPOSTA FASANO TOOLS È DEDICATA SIA AL SETTORE AUTOMOTIVE
CHE A QUELLO INDUSTRIALE, E ALCUNI DEGLI ARTICOLI PRESENTI
IN GAMMA SI DISTINGUONO PER ELEMENTI UNICI E ALTAMENTE
PERFORMANTI.

PER TUTTI GLI UTENSILI FASANO TOOLS GARANTISCE LA COSTANTE
DISPONIBILITÀ DI RICAMBI NEL TEMPO ED UN SERVIZIO DI
MANUTENZIONE ALTAMENTE QUALIFICATO E RAPIDO.



CE



COPPIA DI SPUNTO



MARTELLO SINGOLO



FGA 307

~~225,00€~~

135,00€

AVVITATORE AD IMPULSI-1/2"



CE



COPPIA DI SPUNTO



MARTELLO DOPPIO



FGA 309

~~270,00€~~

159,00€

AVVITATORE AD IMPULSI-1/2"



CE



COPPIA DI SPUNTO



MARTELLO DOPPIO



FGA 312

~~335,00€~~

199,00€

AVVITATORE AD IMPULSI-1/2"



CE



MARTELLO DOPPIO



FGA 302

~~220,00€~~

119,00€

AVVITATORE AD IMPULSI-1/2"



UTENSILI PNEUMATICI

FGA 316

~~665,00€~~ **399,00€**

AVVITATORE AD IMPULSI-3/4"

FGA 316/L

~~735,00€~~ **449,00€**

AVVITATORE AD IMPULSI - 3/4"
AD ALBERO LUNGO 6"

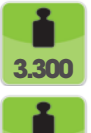

MARTELLINO DOPPIO



FGA 321

~~950,00€~~ **559,00€**

AVVITATORE AD IMPULSI -1"

FGA 321/B

~~1.000,00€~~ **589,00€**

AVVITATORE AD IMPULSI 1"
AD ALBERO LUNGO 6"



MARTELLINO DOPPIO



FGA 319

~~1.050,00€~~ **559,00€**

AVVITATORE AD IMPULSI -1"

FGA 319/L

~~1.150,00€~~ **619,00€**

AVVITATORE AD IMPULSI 1"
AD ALBERO LUNGO 6"



PIN-LESS





PIN-LESS

FGA 321/C

NEW

AVVITATORE AD IMPULSI 1" AD ALBERO LUNGO 6"

~~1.100,00€~~ **599,00€**



IDEALE PER UTILIZZI INTENSIVI



FGA 291/B

MINI-CRICCHETTO REVERSIBILE DA 1/4"



~~115,00€~~ **59,00€**



FGA 292/B

CRICCHETTO REVERSIBILE 1/2"



~~200,00€~~ **119,00€**

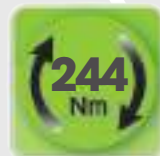

COPPIA TORCENTE



FGA 307AN/S13

KIT COMPOSTO DA AVVITATORE ANGOLARE E SERIE DI 12 CHIAVI A BUSSOLA EXTRA PIATTE



COPPIA DI SPUNTO

MARTELLO SINGOLO



Pulsante di avviamento

Sistema di reversibilità

Corpo ultra compatto

Scarico aria centrale

Doppio livello di velocità regolabile

+ OMAGGIO

FGA 628/S12

SET 12 CHIAVI A BUSSOLA RINFORZATE 1/2"



CONTENUTO: 10, 11, 12, 13, 14, 15, 16, 17, 18, 19, 20, 21 mm

~~315,00€~~ **189,00€**



UTENSILI PNEUMATICI

FGA 332

TRAPANO REVERSIBILE CON
MANDRINO AUTOSERRANTE 1-10MM



| | | |
|--------------|--------------|------------|
| 0.45 Hp | 1.800 RPM | 900 |
| 113 L/min | 1/4" 6mm | 6:2 Bar |

~~133,00€~~ 79,00€

FGA 333

TRAPANO REVERSIBILE CON
MANDRINO AUTOSERRANTE 1-13MM



| | | |
|--------------|-------------|------------|
| 0.45 Hp | 700 RPM | 1.300 |
| 113 L/min | 1/4" 6mm | 6:2 Bar |

~~172,50€~~ 99,00€

FGA 333/AC

TRAPANO REVERSIBILE CON
MANDRINO IN ACCIAIO 1-13MM

~~195,00€~~ 119,00€



| | | |
|--------------|-------------|------------|
| 0.45 Hp | 700 RPM | 1.200 |
| 113 L/min | 1/4" 6mm | 6:2 Bar |



FGA 332/AN

TRAPANO ANGOLARE
MANDRINO AUTOSERRANTE
1-10MM

~~160,00€~~ 96,00€



| | | |
|-------------|--------------|------------|
| 0.45 Hp | 1.800 RPM | 900 |
| 60 L/min | 1/4" 6mm | 6:2 Bar |



FGA 340

- ø orbita: 5.0mm
- platorello 15 fori

~~270,00€~~ 149,00€



| | | |
|---------------|---------------|------------|
| 152mm | 11.000 RPM | 900 |
| 45.2 L/min | 1/2" 13mm | 6:2 Bar |

| | | |
|-------------|---------------|------------|
| 150mm | 11.000 RPM | 800 |
| 46 L/min | 1/4" 6mm | 6:2 Bar |

FGA 340/B

~~270,00€~~ 149,00€

- ø orbita: 2.5mm
- platorello 15 fori



FGA 342/B

LEVIGATRICE
ROTO-ORBITALE
- ø orbita: 2.5mm
- platorello 3 fori

| | | |
|-------------|---------------|------------|
| 75mm | 11.000 RPM | 500 |
| 46 L/min | 1/4" 6mm | 6:2 Bar |

~~260,00€~~ 159,00€



FGA 337

LEVIGATRICE PNEUMATICA
PER RIMOZIONE RESIDUI GOMMOSI

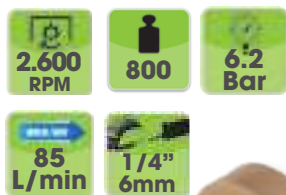

~~115,00€~~ **69,00€**

FGA 330

SEGHETTO ALTERNATIVO



~~266,00€~~ **149,00€**

FGA 339/B

LEVIGATRICE ANGOLARE
- ø disco: 50mm



~~170,00€~~ **99,00€**

DISCHETTI PER FGA 339/B

| CODICE | GRANA | LISTINO | €/PROMO |
|------------------|-------|---------|---------|
| FGA 339/B50-G60 | 60 | 9,00 | 5,40 |
| FGA 339/B50-G80 | 80 | 10,00 | 6,00 |
| FGA 339/B50-G120 | 120 | 12,00 | 7,20 |

FGA 339

LEVIGATRICE ANGOLARE
- ø disco: 115mm

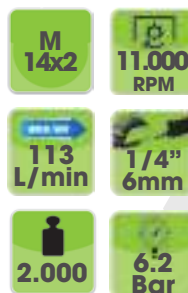

~~295,00€~~ **179,00€**

FGA 335

RIVETTATRICE PNEUMATICA
- 4 testine intercambiabili



~~180,00€~~ **99,00€**

FGA 336

RIVETTATRICE PNEUMATICA
- 4 testine intercambiabili



~~499,00€~~ **299,00€**



UTENSILI PNEUMATICI

FGA 338

LAME ROTORE IN KEVLAR

FGA 334

SMERIGLIATRICE DIRITTA A PINZA

SMERIGLIATRICE DIRITTA A PINZA

~~115,00€~~ 62,50€

~~130,00€~~ 79,00€



CE

CE

FGA 338/B

FGA 334/AN115

SMERIGLIATRICE DIRITTA A PINZA A BASSA VELOCITA'

SMERIGLIATRICE ANGOLARE A PINZA - INCLINAZIONE 115°

~~145,00€~~ 89,00€

~~165,00€~~ 99,00€



CE

CE

FGA 338/AN

FGA 334/AN

SMERIGLIATRICE ANGOLARE A PINZA

SMERIGLIATRICE ANGOLARE A PINZA

~~155,00€~~ 92,50€

~~165,00€~~ 99,00€



CE

CE

FGA 338/L

FGA 334/AL

SMERIGLIATRICE DIRITTA A PINZA AD ALBERO LUNGO

SMERIGLIATRICE DIRITTA A PINZA AD ALBERO LUNGO

~~148,50€~~ 89,00€

~~165,00€~~ 99,00€



CE

CE

FGA 343/N10



LEVIGATRICE A NASTRO
- 10x330mm



~~205,00€~~ **119,00€**

FGA 342

LEVIGATRICE ORBITALE
- ø orbita: 2mm

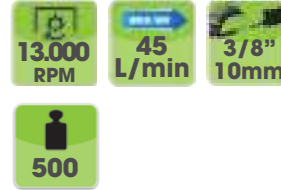

~~180,00€~~ **109,00€**

FGA 343/N20



LEVIGATRICE A NASTRO
- 20X520MM



~~250,00€~~ **149,00€**

FGA 346/S4

KIT COMPOSTO DA MICRO SMERIGLIATRICE
ASSIALE E KIT 3 LIME ROTATIVE IN ACCIAIO DURO

~~166,00€~~ **99,00€**



~~180,00€~~ **109,00€**

FGA 382/AR15

AVVOLGITUBO AUTOMATICO
PER ARIA COMPRESSA

- ø tubo interno: 8x12mm
- Lunghezza tubo: 15metri

~~195,00€~~ **129,00€**

FGA 384/AR15

AVVOLGITUBO AUTOMATICO
PER ARIA COMPRESSA

- ø tubo interno: 11x16mm
- Lunghezza tubo: 15metri

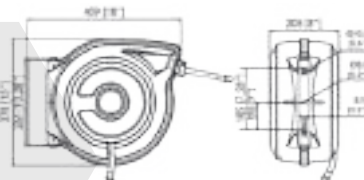
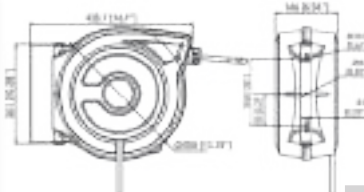

TUBO IN PVC ANTI-SCHIACCIAMENTO
STAFFA A MURO ORIENTABILE A 360°

Guida di scorrimento
automatico



Sistema di bloccaggio
a qualsiasi lunghezza



Riavvolgimento a
velocità controllata





AUTOMOTIVE

FASANO TOOLS PROPONE UNA GAMMA DI UTENSILI SPECIALI DEDICATI AL SETTORE AUTOMOTIVE, IN GRADO DI COPRIRE LE ESIGENZE QUOTIDIANE DI OGNI OPERATORE: DAL MONDO DELLA MECCANICA A QUELLO DEI GOMMISTI, DALLA CARROZZERIA FINO AD ARRIVARE ALLE PIÙ MODERNE APPLICAZIONI RELATIVE AI CAMBI AUTOMATICI O AI VEICOLI IBRIDI ED ELETTRICI.

FASANO TOOLS GARANTISCE ALLA PROPRIA CLIENTELA UN SERVIZIO TECNICO COSTANTE NON SOLO PER L'APPLICAZIONE DEI PROPRI UTENSILI, MA ANCHE PER LO SVILUPPO DI NUOVE SOLUZIONI.



FG 175/S6

SET 6 CHIAVI A TAZZA PER
CARTUCCE FILTRI OLIO

~~55,00€~~

32,90€



FG 175/S30

SET 28 CHIAVI A TAZZA
PER FILTRI OLIO

~~180,00€~~

99,00€

FG 175/F074

NEW

CHIAVE A TAZZA PER FILTRI OLIO
FORD 1.0,2.0,2.3 ECOBOOST



3/8"

FG 175/F074.5

NEW

CHIAVE A TAZZA PER FILTRI OLIO
FORD 1.5, 1.6 ECOBOOST



~~40,00€~~

24,00€

FG 175/F084

NEW

CHIAVE A TAZZA PER FILTRI OLIO
MOTORI MERCEDES



1/2"

~~50,00€~~

29,90€

FG 175/HI

CHIAVE A TAZZA PER FILTRI OLIO
MOTORE HYUNDAI TUCSON



1/2"

~~50,00€~~

29,90€

FG 175/S114

SET RIPARAZIONE
TAPPI OLIO

- M13x1.25
- M13x1.5
- M15x1.5
- M17x1.5
- M20x1.5
- M22x1.5



~~225,00€~~

135,00€

FG 178/UF

IMBUTO UNIVERSALE
PER OLIO



~~52,00€~~

29,90€



AUTOMOTIVE

FG 203/S20

**KIT PER IL CONTROLLO
TENUTA DELL'IMPIANTO
DI RAFFREDDAMENTO**

~~330,00€~~ **195,00€**



21Pz



FG 203/BW1

BMW



FG 203/F01

**FORD Fiesta
dal 2008**



FG 203/F02

FORD



FG 203/OP1

OPEL



FG 203/T01

TOYOTA

TAPPI OPTIONAL

| CODICE | LISTINO | €/PROMO |
|------------|---------|---------|
| FG 203/BW1 | 30,00 | 17,90€ |
| FG 203/F01 | 30,00 | 17,90€ |
| FG 203/F02 | 30,00 | 17,90€ |
| FG 203/OP1 | 30,00 | 17,90€ |
| FG 203/T01 | 30,00 | 17,90€ |

FG 203/A

NEW

**CHIAVE A BUSSOLA PER
SMONTAGGIO TAPPI RADIATORE**

~~20,00€~~ **11,90€**



3/8"



FG 203/S7

**STRUMENTO PER IL RIEMPIMENTO A DEPRESSIONE DEI
CIRCUITI DI RAFFREDDAMENTO**

- Utile per effettuare uno spurgo
perfetto grazie alla messa sotto
vuoto del circuito di raffreddamento

~~140,00€~~ **83,90€**



FG 176/S13

**POMPA PER
INSERIMENTO OLIO
CAMBI E DIFFERENZIALI**

Capacità 7,5 litri



~~380,00€~~ **219,00€**



- Fornito di 12 accessori per connessione diretta
- Dotato di valvola di non ritorno

FG 491/AD550

**SIRINGA PER FLUIDI
DOTATA DI DOPPIA
MANDATA (IN & OUT)**

500CC

~~115,00€~~ **69,00€**



Guarnizioni
in VITON

FG 491/DF1500

**SIRINGA PER ESTRAZIONE
CARBURANTE DEL CIRCUITO
DIESEL**

Dotata di adattatori ad innesto rapido

~~120,00€~~ **72,50€**

1.500CC



FG 491/200

200CC

SIRINGA PER OLIO E FLUIDI
Fornita con 2 guarnizioni di ricambio

~~30,00€~~ **17,90€**



FG 491/1500

1.500CC

SIRINGA PER OLIO
Fornita con 2 guarnizioni di ricambio

~~66,00€~~ **39,90€**

Non adatta per carburanti e olii minerali

FG 491/AD1

IMBUTI PER INSERIMENTO LIQUIDO ADBLUE
1.1 litri

~~42,00€~~ **24,90€**



FG 491/AD2

IMBUTI PER INSERIMENTO LIQUIDO ADBLUE
1.1 litri

~~47,00€~~ **27,90€**



FG 191/S22

~~500,00€~~ **299,00€**

SET UNIVERSALE PER ESTRAZIONE ELETTO-INIETTORI BOSCH, DELPHI, SIEMENS E DENSO
- completo di massa battente 4.8KG

M16



FG 190/AD1

ESTRATTORE A FORCHETTA PER INIETTORI PIEZO ELETTRICI

~~48,50€~~ **29,50€**

M16



FG 190/AD2

ESTRATTORE LATERALE PER ELETTO-INIETTORI BOSCH

~~32,00€~~ **18,90€**

Per le masse battenti da associare ai codici FG 190/AD e FG 190/AD2 consultare il Catalogo generale a pagina 175

FG 190/S8

KIT ESTRAZIONE INIETTORI BMW N54/MINI N14



~~130,00€~~ **79,00€**

FG 190/VW

ESTRATTORE A MASSA BATTENTE PER ELETTO-INIETTORI VAG

~~85,00€~~ **49,90€**

FG 190/IP

UTENSILE PER ESTRAZIONE UGELLO ELETTO-INIETTORI

~~45,00€~~ **26,90€**





FG 190/S21

ASSORTIMENTO 21 UTENSILI E ALESATORI PER PULIZIA SEDI INIETTORI E CANDELETTE

Porta inserto flessibile lungo 1/4"

Porta spazzola con attacco 1/4"

Spazzola corta \varnothing 19mm

Spazzolino lungo \varnothing 7mm

Spazzolino universale

Cappucci per chiusura foro centrale

Asta per cappucci di chiusura

Utensile rimozione rondelle in rame

Utensile con cono di centratura

Coni di centratura

Utensile per fresatura laterale

Adattatore pulizia base iniettore



~~290,00€~~

169,00€



FG 190/S6B

SET PER FRESATURA SEDI INIETTORI

CONTENUTO:

- 01 fresa piana 17x19mm
- 01 fresa piana 15x19mm
- 01 fresa piana 17x17mm
- 01 fresa conica 17x21mm
- 01 fresa conica 17x17mm

~~140,00€~~

84,50€



1/2"
22mm

145mm

FG 175/FT3

CHIAVE REGOLABILE PER GHIERE GALLEGGIANTI SERBATOIO CARBURANTE

per ghiera in plastica FCA (Fiat Freemont, 500L, 500X, Jeep Renegade, ecc)

~~70,00€~~

42,00€



FG 174/SC

CHIAVE REGOLABILE PER GHIERE GALLEGGIANTI SERBATOIO CARBURANTE \varnothing 88-170mm

~~95,00€~~

57,90€



150mm

FG 174/F1

CHIAVE REGOLABILE PER GHIERE GALLEGGIANTI SERBATOIO CARBURANTE GRUPPO FCA

~~65,00€~~

39,50€

FG 174/F2

CHIAVE REGOLABILE PER GHIERE GALLEGGIANTI SERBATOIO CARBURANTE GRUPPO FCA

~~65,00€~~

39,50€



FG 182/S16
SET ESTRAZIONE
CANDELETTE SPEZZATE
 M8, M10, MULTIJET

~~420,00€~~

249,00€



FG 183/S5
SET CHIAVI A BUSSOLA
PER CANDELETTE
PRERISCALDAMENTO
MOTORI DIESEL

8, 9, 10, 12, 14mm

~~98,00€~~

58,90€



3/8"

FG 181/C14

CHIAVE A BUSSOLA SNODATA
PER CANDELE D'ACCENSIONE
MOTORI BMW

~~25,00€~~

14,90€

FG 181/S130

SET RIPRISTINA FILETTI CON ELICOIL

- M5 - 0.8
- M6 - 1.0
- M8 - 1.25
- M10 - 1.5
- M12 - 1.75

~~255,00€~~

149,00€



FG 181/S115

SET RIPRISTINA FILETTI CON ELICOIL

- M6 - 1.0
- M8 - 1.25
- M10 - 1.5
- M12 - 1.75
- M14 - 1.25

~~325,00€~~

189,00€

FG 800/9 **NEW**

CHIAVE SMONTAGGIO
VALVOLE GPL GRUPPO VAG

~~130,00€~~

79,00€



1/2"



FG 179/S16

SET UTENSILI PER PULEGGE
LIBERE ALTERNATORI

~~130,00€~~

79,00€





FG 180/S38

SET CENTRAGGIO FRIZIONI SAC

- 01 piastra a 3 bracci
- 01 piastra a 4 bracci
- 06 centraggi conici
- 09 perni di centraggio

~~600,00€~~ 359,00€

FG 180/S17

SET DIAGNOSI DOPPIE FRIZIONI DMF

~~550,00€~~ 329,00€

FG 178/SF

APPARECCHIO SPURGO LIQUIDO FRENI

- alimentazione 12V con cavi batteria
- dotato di vano posteriore porta oggetti e contenitore di recupero olio
- 2 tappi universali in dotazione

~~1.450,00€~~ 769,00€

TAPPI IN DOTAZIONE



42mm

44,45,46mm

TAPPI SPECIFICI PER MOTORI FORD (NON IN DOTAZIONE DI BASE)



FG 178SF/AD13

Fiesta 2011-2016

~~50,00€~~ 29,90€



FG 178SF/AD14

Mondeo dal 2014
Fiesta dal 2016
Mazda CX3/CX5

~~50,00€~~ 29,90€



Pressione regolabile fino a 2 Bar

Capacità serbatoio 5L

Scocca in acciaio Inox

Dotato di sensore fine liquido

FG 178/S6 **NEW**

KIT TAPPI PER VEICOLI ASIATICI

~~300,00€~~ 179,00€

- TOYOTA
- HYUNDAI
- NISSAN
- MITSUBISHI
- MAZDA
- SUBARU
- HONDA
- SUZUKI



CE

FG 199/PF

SET ARRETRATORE PNEUMATICO PER PISTONCINI FRENI A DISCO

Per destrorsi e sinistrorsi

~~180,00€~~ **109,00€**



FG 198/S11

KIT SMONTAGGIO BULLONI PINZE FRENO

BMW, Ford, VAG, Mercedes

~~120,00€~~ **72,90€**



FG 198/B9

CHIAVE A BUSSOLA PER BULLONI PINZE FRENO - M9

~~15,00€~~ **8,90€**



1/2"

FG 627/S3

CHIAVI A BUSSOLA PER CERCHI IN LEGA LEGGERA

17, 19, 21mm

~~75,00€~~ **45,00€**



DOTATE DI ANELLO MAGNETICO DI TENUTA



FG 125/B400

LEVA CON ESTREMITÀ A PUNTA E PIATTA CURVA

~~21,00€~~ **13,50€**



FG 126/P500

LEVA PER PNEUMATICI CON PROTEZIONE ABS

~~40,00€~~ **24,50€**



FG 164/S3 NEW

KIT RIMOZIONE DADI ANTI FURTO CON COLLARE - BMW

~~150,00€~~ **89,00€**





38mm



FG 169/A44 **NEW**

CHIAVE A BUSSOLA PER SNODI SFERICI PSA

~~50,00€~~ **29,90€**



FG 165/BS...

UTENSILE MONTAGGIO E SMONTAGGIO BRACCETTI STERZO



| CODICE | Ø/MM | Ø MM ESTERNO | ●/MM | L/MM | €/LISTINO | €/PROMO |
|------------|---------|--------------|-------------|------|--------------------|--------------|
| FG 169/BS | 35 - 45 | 89 | 1/2" o 27mm | 400 | 102,00- | 61,50 |
| FG 169/BS1 | 28 - 35 | 73 | 1/2" o 27mm | 400 | 96,00- | 57,90 |
| FG 169/BS3 | 35 - 45 | 89 | 1/2" o 27mm | 190 | 96,00- | 57,90 |

FG 166/S28

KIT PER SMONTAGGIO E MONTAGGIO CUSCINETTI RUOTA

- smontaggio Ø 34-45mm
- montaggio Ø 60-84mm

~~380,00€~~ **229,00€**



FG 166/S7

KIT PER ESTRAZIONE GHIERE CUSCINETTI

- Pinze: Ø 40-45mm, 45-51mm, 50-55mm, 55-61mm
- Chiavi serraggio ghiera: Ø 82.7mm, 58.9mm

~~520,00€~~ **309,00€**



FG 165/S26

~~570,00€~~ **349,00€**

SET UTENSILI SPECIALI PER SMONTAGGIO E MONTAGGIO SILENT BLOCK

- bocche per Ø 44-82mm
- 4 barre filettate M10, M12, M14, M16



FG 165/S7

~~160,00€~~ **98,00€**

KIT SMONTAGGIO E MONTAGGIO SILENT BLOCK FIAT PANDA 4X4 E PANDA METANO



COPPIA MASSIMA



SCocca ANTERIORE IN ACCIAIO RESISTENTE AGLI URTI

1/2"

LED DI PUNTAMENTO

IMPUGNATURA BI-MATERIAL PER UN MAGGIOR GRIP

AGGANCI RINFORZATO

Modalità L:
-900RPM
-200 Nm

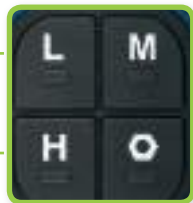

Modalità M:
-1.200RPM
-400 Nm

Modalità H:
-1.900RPM
- 650 Nm

Modalità svitamento soft:
permette di applicare una velocità controllata finché il bullone risulta ancora bloccato

SISTEMA DI SGANCIO RAPIDO

BATTERIA AL LITIO 5.0 AMPERE E 18 VOLT

18V - 5.0A BRUSHLESS MOTOR



FG 166/S4

AVVITATORE FORNITO IN VALIGETTA DI ABS CON 1 BATTERIA AL LITIO

~~800,00€~~

349,00€

FG 166/S4B

AVVITATORE FORNITO IN VALIGETTA DI ABS CON 2 BATTERIE AL LITIO

~~950,00€~~

399,00€

+ IN OMAGGIO

CHIAVI A BUSSOLA RINFORZATE PER CERCHI IN LEGA LEGGERA





AUTOMOTIVE

FG 94/MS

**SUPPORTO MAGNETICO
PORTA UTENSILI**

~~30,00€~~

14,90€



PVC ANTI-GRAFFIO



IDEALE PER PICCOLI AVVITATORI
E PISTOLE DI VERNICIATURA



FG 94/MI

**SUPPORTO MAGNETICO
PORTA UTENSILI**

DIMENSIONI: 120x94x400mm

~~45,00€~~

21,90€



IDEALE PER CHIAVI A BUSSOLA
AVVITATORI PNEUMATICI E
CHIAVE DINAMOMETRICA

**KG
9**

**PORTATA
MASSIMA**



FG 172/PA

**PINZA PER SERRAGGIO E
TAGLIO FASCETTE A NASTRO
IN ACCIAIO INOX**

~~54,00€~~

32,90€



INDICATA ANCHE
PER FASCETTE PANDUIT

FG 172/TG

**PINZA RIMOZIONE TUBI
ACQUA E CARBURANTE**

~~46,50€~~

27,90€



FG 172/AS2

**PINZA PER ANELLI STRINGITUBO
CON PROLUNGA INTERCAMBIABILE**

-Apertura: 3-52mm

~~95,00€~~

57,50€



PROLUNGHE SINGOLE

| CODICE | APERTURA | LISTINO | €/PROMO |
|--------------|------------------------------|---------|---------|
| FG 172/AS2-A | 3-52MM | 23,00 | 13,90 |
| FG 172/AS2-B | 0-75MM | 46,00 | 27,90 |
| FG 172/AS2-C | 0-24MM | 26,50 | 15,90 |
| FG 172/AS2-D | PER CONNETTORI CARBURANTE | 29,50 | 17,90 |

FG 172/CL

**PINZA PER FASCETTE
A SCATTO CLIC**

~~44,00€~~

26,90€



FG 172/TC

**PINZA PER RIMOZIONE
PIOLI CATENE**

~~50,00€~~

29,90€



FG SERVICE 106

KIT PROTEZIONE VEICOLI

~~155,00€~~

89,00€

50 COPRISIEDILI IN POLIETILENE DA 20 MICRON

50 TAPPETINI 45X35CM

OLTRE **500 METRI** DI FILM COPRI-VOLANTE

2 MANOPOLE PER BOBINA COPRI-VOLANTE



FG 99

NEW

AVVIATORE 12 V - 2.000A

~~500,00€~~

259,00€

FG 99/B

AVVIATORE 12 V - 2.500A

~~620,00€~~

329,00€

CE



CARATTERISTICHE TECNICHE:

- Batteria ermetica al piombo (AGM)
- Alimentazione: 220V e accendisigari 12V





AUTOMOTIVE



FG 186P/S5

SET 5 LEVE IN NYLON
RIMOZIONE PIOLI

~~28,00€~~ 16,90€



FG 186/S5

SET 5 LEVE CON LAMA
IN ACCIAIO INOX

~~82,00€~~ 49,00€



FG 186/S3

SET 3 LEVERINI IN
MATERIALE PLASTICO

~~9,00€~~ 5,50€



FG 186/S3B

SET 3 UNCINI IN
MATERIALE PLASTICO

~~10,50€~~ 6,40€



FG 186/S11

SET 11 UTENSILI IN NYLON
PER CARROZZERIA

~~105,00€~~ 65,00€



FG 130/S10

SET 10 UTENSILI
PER CARROZZERIA

~~490,00€~~ 289,00€



FG 131/TR



FG 131/TB



FG 131/TC



FG 131/TV



FG 131/SC



FG 130/TQ



FG 130/TPP



FG 136/30



FG 131/PL12



FG 131/SCZ



FG 187/S7

SET 7 UTENSILI PER CRISTALLI AUTO

~~185,00€~~ **109,00€**



FG 187/K10

KIT 4 MINI-VENTOSE PER CRISTALLI AUTO - capacità 10Kg

~~21,00€~~ **12,90€**

FG 186/AS

GIRAVITE ANGOLARE

~~36,00€~~ **19,90€**



FG 187/K130

VENTOSA SINGOLA MULTIFUNZIONE

- Capacità: 130Kg
- Diametro: 254mm
- Adatta per parabrezza autobus e mezzi pesanti
- Fornita in box di ABS

~~252,00€~~ **149,00€**



FG 187/PN

TIRABOLLI PNEUMATICO, COMPLETO DI 3 VENTOSE

~~225,00€~~ **138,00€**





AUTOMOTIVE

ACCESSORI DI BASE IN DOTAZIONE



FG 215

TESTER PROVA COMPRESIONE DIGITALE

CARATTERISTICHE TECNICHE:

- grado di precisione: 1%FS
- software in 8 lingue (IT, EN, DE, FR, ES, PT, GR, PL)
- display touch screen LCD retroilluminato a colori, 4.3"

MADE IN ITALY

FG 215/S40

TESTER PROVA COMPRESIONE DIGITALE, COMPLETO DI FINTI INIETTORI E FINTE CANDELETTE PER SISTEMI DIESEL

~~800,00€~~ **479,00€**

~~1.350,00€~~ **799,00€**

FG 215 È UN TESTER DIGITALE IN GRADO DI MISURARE LA COMPRESIONE DEI SISTEMI AD ALIMENTAZIONE DIESEL E BENZINA. IDEATO, INGEGNERIZZATO E PRODOTTO INTERAMENTE IN ITALIA, RAPPRESENTA UNA VERA RIVOLUZIONE TECNOLOGICA!

FUNZIONE PROVA ALTERNATORE

SCHEMATA PRINCIPALE FG 215



FUNZIONE PROVA COMPRESIONE E TENSIONE BATTERIA

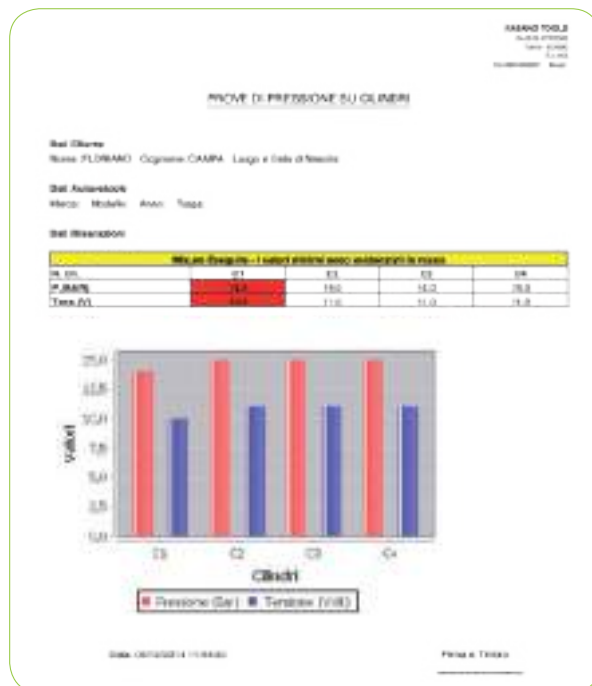
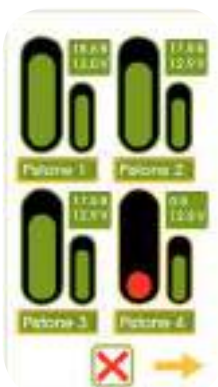

MADE IN ITALY

FG 219/S



**TESTER MULTI-FUNZIONE
PER PROVA COMPRESIONE
E PROVA PRESSIONE CARBURANTI**

CARATTERISTICHE TECNICHE:

- grado di precisione: 1%FS
- software in 8 lingue (IT, EN, DE, FR, ES, PT, GR, PL)
- display touch screen LCD retroilluminato a colori, 4,3"
- 2 sensori (0-80Bar e 0.2500Bar)

~~2.700,00€~~

1.699,00€



**POSSIBILITÀ DI MEMORIZZARE
E SCARICARE LE PROVE SU PC,
PERSONALIZZANDO LA SCHEDA
DATI CON TUTTE LE INFORMAZIONI
DEL CLIENTE DELLA PROPRIA
AUTOFFICINA (INCLUSO IL LOGO)**

SCHERMATA PRINCIPALE
FG 219



**PROVA ALTERNATORE
PROVA COMPRESIONE
PROVA TENSIONE BATTERIA**



**PROVA PRESSIONE CARBURANTE
(ALTA E BASSA)**



PROVA OLIO MOTORE





CARRELLI E BANCHI DA LAVORO

LA GAMMA DI CARRELLI PORTA UTENSILI FASANO TOOLS È COMPOSTA DA 11 MODELLI DIVERSI, CHE A LORO VOLTA SI COMPONGONO DI DIVERSE VARIANTI DI COLORE, DI NUMERO DI CASSETTI E TIPOLOGIA DI TOP. PER OGNI ESIGENZA QUOTIDIANA L'UTILIZZATORE PUÒ TROVARE LA SOLUZIONE PIÙ ADEGUATA ALLE PROPRIE ESIGENZE, CON UN OCCHIO PARTICOLARE ALL'IMMAGINE E ALLA CURA DEI PARTICOLARI.



FG 101

NEW

CARRELLO PORTA UTENSILI MOD. FG 101

CARATTERISTICHE TECNICHE:

- Guide telescopiche con sistema di aggancio automatico
- 4 ruote in gomma vulcanizzata Ø125mm (2 fisse e 2 girevoli - 1 con freno)
- maniglione laterale in acciaio
- chiusura centralizzata
- cassetti dotati di tappetino interno in gomma



SISTEMA DI APERTURA A BAIONETTA



MANIGLIONE IN ACCIAIO



TOP IN GOMMA



PORTATA
STATICA

| CODICE | CASSETTI | €/LISTINO | €/PROMO |
|------------|------------|-----------|---------|
| FG 101V/5G | 5 CASSETTI | 600,00 | 329,00 |
| FG 101V/6G | 6 CASSETTI | 625,00 | 349,00 |
| FG 101V/7G | 7 CASSETTI | 660,00 | 369,00 |



FG 102

CARRELLO PORTA UTENSILI MOD. FG 102

CARATTERISTICHE TECNICHE:

- Guide telescopiche con sistema di aggancio automatico
- 4 ruote in gomma vulcanizzata Ø125mm
- maniglione laterale in acciaio
- chiusura centralizzata
- cassetti dotati di tappetino interno in gomma



4 RUOTE Ø125
(2 GIREVOLI-2 FISSE)



MANIGLIONE IN ACCIAIO



TOP IN GOMMA

MADE IN ITALY



PORTATA
STATICA



| CODICE | Cassetti | €/Listino | €/PROMO |
|------------|------------|-----------|---------|
| FG 102V/5G | 5 CASSETTI | 850,00 | 429,00 |
| FG 102V/6G | 6 CASSETTI | 900,00 | 469,00 |
| FG 102V/7G | 7 CASSETTI | 950,00 | 499,00 |
| FG 102V/8G | 8 CASSETTI | 1.000,00 | 519,00 |

FG 102



CARRELLI E BANCHI DA LAVORO



FG 100

FG 100

CARRELLO PORTA UTENSILI MOD. FG 100

CARATTERISTICHE TECNICHE:

- Guide telescopiche con sistema di aggancio automatico
- 4 ruote in gomma vulcanizzata Ø125mm
- ripiano superiore in ABS con maniglione integrato
- chiusura laterale centralizzata
- porta flaconi laterali di serie

MADE IN ITALY



SISTEMA DI CHIUSURA LATERALE



RIPIANO SUPERIORE IN ABS



CASSETTO CON APERTURA COMPLETA



KG 800 PORTATA STATICA

| CODICE | | | CASSETTI | €/LISTINO | €/PROMO |
|------------|------------|------------|------------|-----------|---------|
| FG 100V/5T | FG 100B/5T | FG 100R/5T | 5 CASSETTI | 1.150,00 | 489,00 |
| FG 100V/6T | FG 100B/6T | FG 100R/6T | 6 CASSETTI | 1.200,00 | 509,00 |
| FG 100V/7T | FG 100B/7T | FG 100R/7T | 7 CASSETTI | 1.250,00 | 529,00 |



FG 150

FG 150

CARRELLO PORTA UTENSILI MOD. FG 150

CARATTERISTICHE TECNICHE:

- Guide telescopiche con sistema di aggancio automatico
- 4 ruote in gomma vulcanizzata Ø125mm
- maniglione laterale in acciaio
- chiusura centralizzata
- cassetti dotati di tappetino interno in gomma

MADE IN ITALY



4 RUOTE Ø125 (2 GIREVOLI-2 FISSE)



TAPPETINO INTERNO



MANIGLIONE IN ACCIAIO INOX



KG 800 PORTATA STATICA

| CODICE | | | CASSETTI | €/LISTINO | €/PROMO |
|------------|------------|------------|----------|-----------|---------|
| FG 150R/5G | FG 150D/5G | 5 CASSETTI | 930,00 | 519,00 | |
| FG 150R/6G | FG 150D/6G | 6 CASSETTI | 965,00 | 539,00 | |
| FG 150R/7G | FG 150D/7G | 7 CASSETTI | 1.000,00 | 559,00 | |

FG 104

CARRELLO PORTA UTENSILI MOD. FG 104

CARATTERISTICHE TECNICHE:

- Guide telescopiche con sistema di aggancio automatico
- 4 ruote in gomma vulcanizzata Ø125mm
- maniglione laterale in acciaio
- chiusura centralizzata
- cassetti dotati di tappetino interno in gomma

MADE IN ITALY



MANIGLIONE IN ACCIAIO INOX



CHIUSURA CENTRALIZZATA



KG 1000 PORTATA STATICA

FG 104
MFA XL

| CODICE | | | | CASSETTI | €/LISTINO | €/PROMO |
|------------|------------|------------|------------|------------|---------------------|---------|
| FG 104V/6G | FG 104D/6G | FG 104B/6G | FG 104R/6G | 6 CASSETTI | 1.100,00 | 559,00 |
| FG 104V/7G | FG 104D/7G | FG 104B/7G | FG 104R/7G | 7 CASSETTI | 1.150,00 | 599,00 |

FG 105

CARRELLO PORTA UTENSILI MOD. FG 105

CARATTERISTICHE TECNICHE:

- Guide telescopiche con sistema di aggancio automatico
- 4 ruote in gomma vulcanizzata Ø125mm
- maniglione laterale in acciaio
- chiusura centralizzata
- cassetti dotati di tappetino interno in gomma

MADE IN ITALY



RIPIANI INTERNI REGOLABILI



ANTINA APRIBILE A 90°, DOTATA DI SERRATURA



FG 105
XL

| CODICE | | | | CASSETTI | €/LISTINO | €/PROMO |
|------------|------------|------------|------------|------------|---------------------|---------|
| FG 105V/5G | FG 105B/5G | FG 105R/5G | FG 105D/6G | 5 CASSETTI | 1.100,00 | 599,00 |
| FG 105V/6G | FG 105B/6G | FG 105R/6G | FG 105D/6G | 6 CASSETTI | 1.175,00 | 649,00 |
| FG 105V/7G | FG 105B/7G | FG 105R/7G | FG 105D/7G | 7 CASSETTI | 1.225,00 | 679,00 |



CARRELLI E BANCHI DA LAVORO

FG 160

CARRELLO PORTA UTENSILI MOD. FG 160

CARATTERISTICHE TECNICHE:

- Guide telescopiche con sistema di aggancio automatico
- 4 ruote in gomma vulcanizzata Ø160mm
- maniglione laterale in acciaio
- chiusura centralizzata
- cassetti dotati di tappetino interno in gomma



- Antina apribile a 90°, dotata di serratura con chiave
- 2 ripiani interni amovibili



- 7 cassetti porta minuteria
- Profondità: 580x235mm



KG 2.400 PORTATA STATICA



- Larga griglia laterale porta utensili
- Dimensioni: 665x595mm

| CODICE | CASSETTI | €/LISTINO | €/PROMO | | | |
|-------------|-------------|-------------|-------------|-------------|---------------------|-----------------|
| FG 160V/14L | FG 160B/14L | FG 160R/14L | FG 160D/14L | 14 CASSETTI | 3.000,00 | 1.499,00 |

JUMBO

MADE IN ITALY

FG 102/PL

PORTA LATTINE
PER FG 102, FG 103,
FG 104, FG 105, FG 109

~~52,50€~~

31,50€



FG 102/PR

PORTA ROTOLO
PER FG 102, FG 103,
FG 104, FG 105, FG 109

~~56,00€~~

33,90€



FG 94/R

PORTA MINUTERIE MAGNETICO

Dimensione: 165x245mm

~~18,00€~~

10,90€



FG 94/T

PORTA MINUTERIE MAGNETICO

Ø 150mm

~~15,00€~~

8,90€



FG 101V/AS190

**CARRELLO PORTA UTENSILI FG 101
A 7 CASSETTI CON ASSORTIMENTO
190 UTENSILI IN MODULI RIGIDI**

~~1,841,00€~~ **799,00€**

**KG
500** PORTATA
STATICA

1°CASSETTO

- **FG 102/03G:** Modulo 14 chiavi combinate 6 - 19mm
- **FG 102/21B:** Modulo chiavi a bussola esagonali 1/2" 8-32mm+accessori
- **FG 102/17E:** Modulo 65 utensili da 1/4"



3°CASSETTO

- **FG 102/48G:** Modulo 52 inserti con attacco 10mm
- **FG 102/65B:** Modulo pinza autobloccante e pinza a cerniera
- **FG 102/23C:** Modulo 14 utensili rinforzati da 1/2"



2°CASSETTO

- **FG 102/39D:** Modulo 3 pinze
- **FG 102/VA1:** Modulo porta minuterie
- **FG 102/45D:** Modulo 6 giraviti a taglio e a croce



4°CASSETTO

- **FG 102/10C:** Modulo 8 chiavi a T snodate esagonali 7-19mm





CARRELLI E BANCHI DA LAVORO

FG 102V/AS149

**CARRELLO PORTA UTENSILI FG 102
A 7 CASSETTI CON ASSORTIMENTO
149 UTENSILI IN MODULI RIGIDI**

~~2.076,50€~~

899,00€

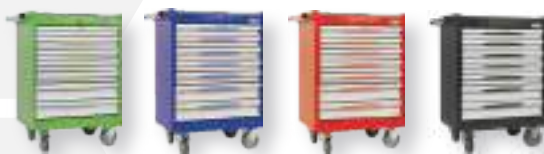

**KG
800** PORTATA
STATICA

| CODICE | | €/LISTINO | €/PROMO |
|---------------|---------------|-----------|---------|
| FG 102V/AS149 | FG 102B/AS149 | 2.076,50 | 899,00 |

1°CASSETTO

- **FG 102/03G:** Modulo 14 chiavi combinate 6 - 19mm
- **FG 102/VA1:** Modulo porta minuterie
- **FG 102/03L:** Modulo rigido 6 chiavi combinate



3°CASSETTO

- **FG 102/45E:** Modulo 8 giraviti ad intaglio e a croce Phillips
- **FG 102/45I:** Modulo 6 giraviti con impronta Torx
- **FG 102/48D:** Modulo 40 inserti da 1/4" + porta inserti



2°CASSETTO

- **FG 102/17:** Modulo chiavi a bussola da 1/4" 4-14mm + accessori
- **FG 102/19:** Modulo 18 utensili da 3/8"
- **FG 102/21B:** Modulo 25 utensili da 1/2"



4°CASSETTO

- **FG 102/39D:** Modulo 3 pinze con manici in pvc
- **FG 102/42C:** Modulo 4 pinze per anelli elastici 19-60mm
- **FG 102/65B:** Modulo pinza autobloccante e pinza regolabile a cerniera aperta





FG 102V/AS158

**CARRELLO PORTA UTENSILI FG 102
A 6 CASSETTI CON ASSORTIMENTO
158 UTENSILI IN MODULI RIGIDI**

~~2,287,00€~~ **949,00€**



KG 800 PORTATA
STATICA

| CODICE | | | | €/LISTINO | €/PROMO |
|---------------|---------------|---------------|---------------|-----------|---------|
| FG 102V/AS158 | FG 102B/AS158 | FG 102R/AS158 | FG 102D/AS158 | 2.287,00 | 949,00 |

1°CASSETTO

- **FG 102/03G:** Modulo 14 chiavi combinate 6 - 19mm
- **FG 102/21B:** Modulo chiavi a bussola esagonali 1/2" 8-32mm + accessori
- **FG 102/17:** Modulo chiavi a bussola da 1/4" 4-14mm + accessori



3°CASSETTO

- **FG 102/45F:** Modulo 6 giraviti a croce phillips
- **FG 102/45G:** Modulo 7 giraviti ad intaglio
- **FG 102/45I:** Modulo 6 giraviti TORX



2°CASSETTO

- **FG 102/21TX:** Modulo 44 utensili TORX
- **FG 102/21H:** Modulo rigido inserti a bussola 1/2" esagonali e XZN
- **FG 102/39D:** Modulo 3 pinze con manici in pvc



4°CASSETTO

- **FG 102/10C:** Modulo 8 chiavi a T snodate esagonali 7-19mm





CARRELLI E BANCHI DA LAVORO



FG 100V/AS193

**CARRELLO PORTA UTENSILI FG 100
A 7 CASSETTI CON ASSORTIMENTO
193 UTENSILI IN MODULI RIGIDI**

~~2,501,00€~~

999,00€



**KG
800** PORTATA
STATICA

| CODICE | | | €/LISTINO | €/PROMO |
|---------------|---------------|---------------|-----------|---------|
| FG 100V/AS193 | FG 100B/AS193 | FG 100R/AS193 | 2.501,00 | 999,00 |

1°CASSETTO

- **FG 102/03G:** Modulo 14 chiavi combinate 6 - 19mm
- **FG 102/03L:** Modulo rigido 6 chiavi combinate
- **FG 102/21B:** Modulo chiavi a bussola esagonali 1/2" 8-32mm + accessori



3°CASSETTO

- **FG 102/39D:** Modulo 3 pinze
- **FG 102/42C:** Modulo 4 pinze per anelli elastici 19-60mm
- **FG 102/45D:** Modulo 6 giraviti a taglio e a croce



2°CASSETTO

- **FG 102/17E:** Modulo 65 utensili da 1/4"
- **FG 102/48G:** Modulo inserti corti e lunghi con attacco 10mm
- **FG 102/45I:** Modulo 6 giraviti con impronta Torx



4°CASSETTO

- **FG 102/56C:** Modulo utensili da percussione
- **FG 102/65B:** Modulo pinza autobloccante e inza regolabile a cerniera aperta
- **FG 102/62B:** Modulo 5 lime a taglio mezzodolce





FG 100V/AS229

**CARRELLO PORTA UTENSILI FG 100
A 7 CASSETTI CON ASSORTIMENTO
229 UTENSILI IN MODULI RIGIDI**

~~2,650,00€~~ **999,00€**



KG 800 **PORTATA
STATICA**

| CODICE | | | €/LISTINO | €/PROMO |
|---------------|---------------|---------------|-----------|---------|
| FG 100V/AS229 | FG 100B/AS229 | FG 100R/AS229 | 2.650,00 | 999,00 |

1°CASSETTO

- **FG 102/03G:** Modulo 14 chiavi combinate 6 - 19mm
- **FG 102/03L:** Modulo rigido 6 chiavi combinate
- **FG 102/21B:** Modulo chiavi a bussola esagonali 1/2" 8-32mm + accessori



3°CASSETTO

- **FG 102/39D:** Modulo 3 pinze
- **FG 102/45D:** Modulo 6 giraviti a taglio e a croce
- **FG 102/45I:** Modulo 6 giraviti con impronta Torx



2°CASSETTO

- **FG 102/17E:** Modulo 65 utensili da 1/4"
- **FG 102/48G:** Modulo inserti corti e lunghi con attacco 10mm
- **FG 102/21TX:** Modulo 44 utensili Torx



4°CASSETTO

- **FG 102/10C:** Modulo 8 chiavi a T snodate esagonali 7-19mm





CARRELLI E BANCHI DA LAVORO



FG 102/03G

~~118,00€~~ **69,90€**

MODULO RIGIDO 14 CHIAVI COMBinate

6, 7, 8, 9, 10, 11, 12, 13, 14, 15, 16, 17, 18, 19 mm



FG 102/03H

MODULO RIGIDO 18 CHIAVI COMBinate

6, 7, 8, 10, 11, 12, 13, 14, 16, 17, 18, 19, 21, 22, 24, 27, 30, 32 mm

~~220,00€~~ **129,00€**



FG 102/03L

~~122,00€~~ **72,90€**

MODULO RIGIDO 6 CHIAVI COMBinate

21, 22, 24, 27, 30, 32 mm



FG 102/03E

MODULO RIGIDO 8 CHIAVI A DOPPIA FORCHETTA

6x7-20x22 mm + 139C/FS

~~68,50€~~ **39,90€**



FG 102/03F

MODULO RIGIDO 5 CHIAVI A DOPPIA FORCHETTA

21x23, 24x26, 25x28, 27x29, 30x32 mm

~~75,00€~~ **45,00€**



FG 102/07C

~~77,50€~~ **45,90€**

MODULO 7 CHIAVI DOPPIE POLIGONALI

6x7, 8x9, 10x11, 12x13, 14x15, 16x17, 18x19mm



FG 102/07D

~~112,50€~~ **66,90€**

MODULO 5 CHIAVI DOPPIE POLIGONALI

20x22, 21x23, 24x27, 25x28, 30x32mm



FG 102/08C

~~190,00€~~ **115,00€**

MODULO 8 CHIAVI COMBinate A CRICCO REVERSIBILE

8, 10, 11, 12, 13, 14, 15, 16, 17, 18, 19mm



FG 102/10C

MODULO 8 CHIAVI A T SNODATE ESAGONALI

7, 8, 10, 11, 13, 14, 17, 19 mm

~~245,00€~~ **149,00€**



FG 102/13C

~~145,00€~~ **85,00€**

MODULO 10 CHIAVI A PIPA ESAGONALI-POLIGONALI

6,7,8,10,11,12,13,14, 17,19mm



FG 102/17

MODULO 18 UTENSILI DA 1/4"

4-14mm

~~98,00€~~ **59,90€**



FG 102/17E

MODULO 65 UTENSILI DA 1/4"

~~240,00€~~ **145,00€**



FG 102/19

MODULO 18 UTENSILI DA 3/8"
8-23mm ESAGONALI

~~180,00€~~ **109,00€**



FG 102/19B

MODULO 18 UTENSILI DA 3/8"
8-23mm POLIGONALI

~~160,00€~~ **98,00€**



FG 102/21B

MODULO 25 UTENSILI DA 1/2"
10-32mm ESAGONALI

~~202,00€~~ **122,50€**



FG 102/21C

MODULO 25 UTENSILI DA 1/2"
10-32mm POLIGONALI

~~202,00€~~ **122,50€**



FG 102/21E

MODULO 16 UTENSILI DA 1/2"
10-32mm ESAGONALI

~~135,00€~~ **82,50€**



FG 102/21D

MODULO 16 UTENSILI DA 1/2"
10-32mm POLIGONALI

~~135,00€~~ **82,50€**



FG 102/21TX

MODULO 44 UTENSILI TORX

~~210,00€~~ **125,00€**



FG 102/21H

MODULO RIGIDO INSERTI A BUSSOLA 1/2" ESAGONALI E XZN

~~310,00€~~ **109,00€**

FG 102/25

MODULO 9 UTENSILI DA 3/4"
34-50mm ESAGONALI

~~350,00€~~
199,00€



FG 102/25B

MODULO 9 UTENSILI DA 3/4"
34-50mm POLIGONALI

~~350,00€~~
199,00€



FG 102/21R

MODULO INSERTI A BUSSOLA RIBBE
R4-R14, LR4, LR14

~~266,00€~~ **119,00€**



FG 102/23C

MODULO 14 UTENSILI RINFORZATI DA 1/2"
10,11,12,13,14,16,17,18,19,21,22,23,24mm + FG 628/PR125

~~105,00€~~ **65,00€**



FG 102/51H

MODULO 7 CHIAVI A T MASCHIO ESAGONALI
10,11,12,2, 2.5, 3, 4, 5, 6, 8mm

~~103,50€~~ **62,50€**



FG 102/39C

MODULO 3 PINZE SOFT-RUN
FG 59SR/180, FG 61SR/160, FG 63SR/160

~~72,00€~~ **42,90€**



FG 102/39D

MODULO 3 PINZE CON MANICI IN PVC
FG 59PV/180, FG 61PV/160, FG 63PV/160

~~62,00€~~ **36,90€**



CARRELLI E BANCHI DA LAVORO



FG 102/41C

~~85,00€~~

49,90€

MODULO 4 PINZE PER ANELLI ELASTICI

Capacità: 8-25mm



FG 102/42C

~~90,00€~~

54,90€

MODULO 4 PINZE PER ANELLI ELASTICI

Capacità: 19-60mm



FG 102/45D

~~38,00€~~

22,90€

MODULO 6 GIRAVITI AD INTAGLIO E A CROCE PHILLIPS

3x100, 4x125, 5.5x150, 6.5x150, PH1x80, PH2x150



FG 102/45E

~~48,50€~~

29,50€

MODULO 8 GIRAVITI AD INTAGLIO E A CROCE PHILLIPS

3x100, 4x125, 5.5x150, 6.5x150, 6.5x38PH1x80, PH2x150, PH2x38



FG 102/45U

MODULO 12 GIRAVITI AD INTAGLIO E A CROCE PHILLIPS

2.5x60, 3x75, 4x30, 4x100, 5.5x150, 8x150, PH0x60, PH1x30, PH1x80, PH2x100, PH3x150

~~73,00€~~

43,90€



FG 102/45F

~~45,00€~~

26,90€

MODULO 6 GIRAVITI A CROCE PHILLIPS

PH0x60, PH1x150, PH2x100, PH2x150, PH3x150, PH2x38



FG 102/45G

~~42,00€~~

24,90€

MODULO 7 GIRAVITI AD INTAGLIO

2.5x60, 3x100, 3.5x100, 4x125, 5.5x150, 5.5x100, 6.5x150



FG 102/45I

~~55,00€~~

32,90€

MODULO 6 GIRAVITI TORX

TX10, TX15, TX20, TX25, TX27, TX30



FG 102/45L

~~57,00€~~

33,90€

MODULO 6 GIRAVITI TORX CON FORO

RTX10, RTX15, RTX20, RTX25, RTX27, RTX30



FG 102/45T

~~57,50€~~

34,50€

MODULO 5 GIRAVITI A BUSSOLA ESAGONALI

FX6, FX7, FX8, FX10, FX13



FG 102/48D

~~88,00€~~

49,90€

MODULO 40 INSERTI DA 1/4"
+ PORTA INSERTI



FG 102/48G

~~108,00€~~

65,50€

MODULO 52 INSERTI DA 10MM
+ ADATTATORE PER CRICCHETTO DA 1/2"

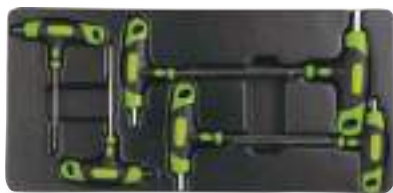

FG 102/50F

~~65,00€~~

39,90€

MODULO 6 CHIAVI MASCHIO ESAGONALI
2, 2.5, 3, 4, 5, 6mm



FG 102/50G

~~65,00€~~

39,90€

MODULO 6 CHIAVI MASCHIO TORX
TX10, TX15, TX20, TX25, TX27, TX30



FG 102/56C

~~98,00€~~

58,90€

MODULO UTENSILI DA PERCUSSIONE
FG 132/500, FG 136/40, FG 126/SN1, FG 126/SN3



FG 102/60C

~~35,00€~~

21,00€

MODULO UTENSILI PER MANUTENZIONE
FG 50/MS, FG 48/L, FG 497/OP1, FG 44/MT5



FG 102/62B

~~68,00€~~

41,50€

MODULO 5 LIME A TAGLIO MEZZODOLCE



FG 102/62C

~~68,00€~~

41,50€

MODULO 5 LIME A TAGLIO BASTARDO



FG 102/65B

~~50,00€~~

29,90€

MODULO PINZA AUTOBLOCCANTE
E PINZA REGOLABILE A CERNIERA APERTA



FG 102/VA1

~~13,00€~~

7,90€

MODULO PORTA MINUTERIE



CARRELLI E BANCHI DA LAVORO



FG 102V/AS161

**CARRELLO PORTA UTENSILI FG 102
A 6 CASSETTI CON ASSORTIMENTO
161 UTENSILI IN MODULI DI GOMMA**

~~2.065,50€~~ **999,00€**



KG 800 **PORTATA STATICA**

| CODICE | | | | €/LISTINO | €/PROMO |
|---------------|---------------|---------------|---------------|-----------|---------|
| FG 102D/AS161 | FG 102B/AS161 | FG 102R/AS161 | FG 102V/AS161 | 2.065,50- | 999,00 |

1°CASSETTO

- **FG 100/03G:** Modulo 14 chiavi combinate 6 - 19mm
- **FG 100/VA1:** Modulo porta minuterie
- **FG 100/07C:** Modulo 7 chiavi doppie poligonali

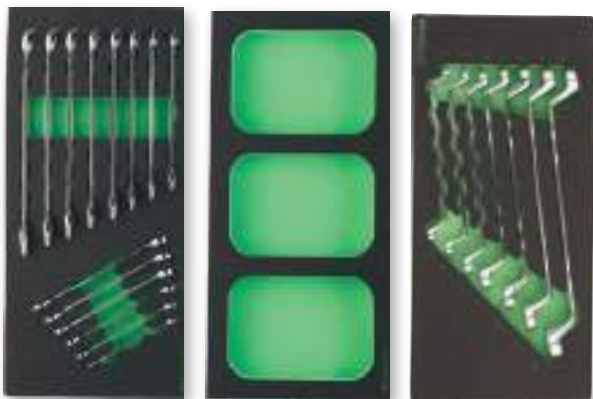

2°CASSETTO

- **FG 100/17:** Modulo 11 chiavi a bussola da 1/4" esagonali + accessori
- **FG 100/19:** Modulo chiavi a bussola esagonali
- **FG 100/21B:** Modulo 25 utensili da 1/2"



3°CASSETTO

- **FG 100/39C:** Modulo 3 pinze assortite
- **FG 100/VA1:** Modulo porta minuterie
- **FG 100/48G:** Modulo 52 inserti da 10mm

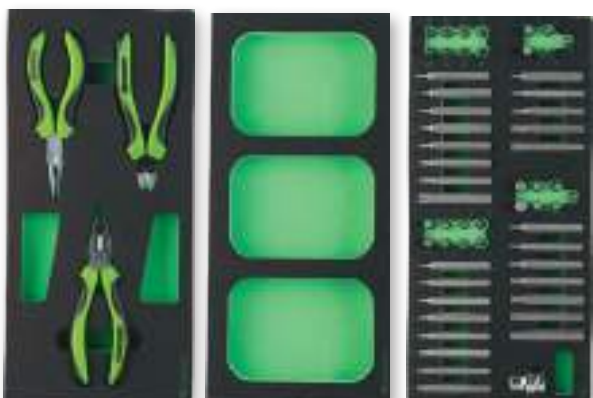

4°CASSETTO

- **FG 100/45F:** Modulo 6 giraviti a croce Phillips
- **FG 100/45G:** Modulo 7 giraviti a taglio
- **FG 100/45I:** Modulo 6 giraviti TORX

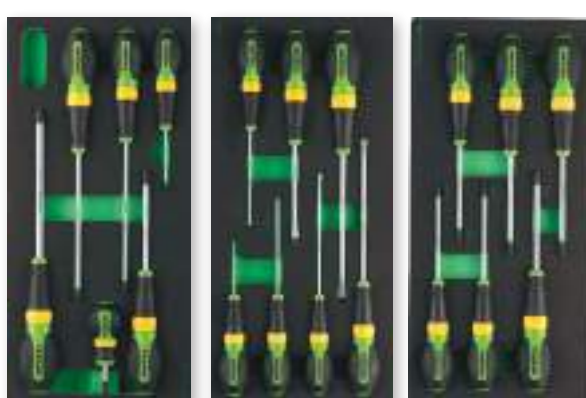



FG 100V/AS226

**CARRELLO PORTA UTENSILI FG 100
A 7 CASSETTI CON ASSORTIMENTO
226 UTENSILI IN MODULI DI GOMMA**

~~2.706,00€~~ **1.099,00€**



KG 800 PORTATA
STATICA

| CODICE | €/LISTINO | €/PROMO |
|---------------|-----------|----------|
| FG 100V/AS226 | 2.706,80 | 1.099,00 |

1°CASSETTO

- **FG 100/03G:** Modulo 14 chiavi combinate 6 - 19mm
- **FG 100/17E:** Modulo 11 chiavi a bussola da 1/4" esagonali + accessori
- **FG 100/21B:** Modulo chiavi a bussola esagonali 1/2" 8-32mm + acc.



3°CASSETTO

- **FG 100/45I:** Modulo 6 giraviti con impronta Torx
- **FG 100/45E:** Modulo 8 giraviti a taglio e croce Phillips
- **FG 100/48G:** Modulo inserti cortie e lunghi con attacco 10mm



2°CASSETTO

- **FG 100/39C:** Modulo 3 pinze assortite
- **FG 100/VA1:** Modulo porta minuterie
- **FG 100/21TX:** Modulo 44 utensili TORX



4°CASSETTO

- **FG 100/10C:** Modulo 8 chiavi a T snodate 7-19mm





CARRELLI E BANCHI DA LAVORO



KG 800 PORTATA STATICA

| CODICE | | €/LISTINO | €/PROMO |
|---------------|---------------|-----------|----------|
| FG 150R/AS173 | FG 150D/AS173 | 2.747,00 | 1.199,00 |

FG 150R/AS173

**CARRELLO PORTA UTENSILI
A 7 CASSETTI CON ASSORTIMENTO
173 UTENSILI IN MODULI DI GOMMA**

~~2.747,00€~~ **1.199,00€**

1°CASSETTO

- **FG 100/03G:** Modulo 14 chiavi combinate 6 - 19mm
- **FG 100/VA1:** Modulo di riempimento con vani porta minuteria
- **FG 100/03E:** Modulo 8 chiavi a forchetta 6x7-20x22mm + set 9 chiavi maschio esagonali



2°CASSETTO

- **FG 100/17:** Modulo 11 chiavi a bussola da 1/4" esagonali + acc.
- **FG 100/21TX:** Modulo 44 utensili con impronta TORX
- **FG 100/21B:** Modulo chiavi a bussola esagonali 1/2" 8-32mm + acc.



3°CASSETTO

- **FG 100/81F:** Modulo inserti a bussola da 1/2" esagonali e XZN
- **FG 100/42C:** Modulo 4 pinze per anelli elastici 19-60mm
- **FG 100/65B:** Modulo pinze autobloccanti e a cerniera



4°CASSETTO

- **FG 100/39C:** Modulo 3 pinze assortite
- **FG 100/45D:** Modulo 6 giraviti ESTRO a taglio e croce PH
- **FG 100/45I:** Modulo 6 giraviti con impronta TORX



5°CASSETTO

- **FG 100/10C:** Modulo 8 chiavi a T snodate 7-19mm

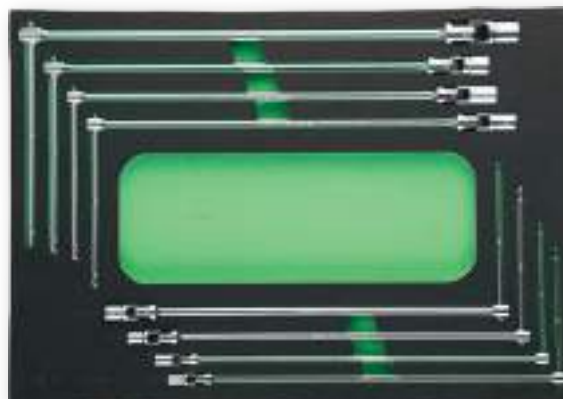



FG 100V/AS230

**CARRELLO PORTA UTENSILI FG 100
7 CASSETTI CON ASSORTIMENTO
230 UTENSILI IN MODULI IN GOMMA**

~~3.348,00€~~ **1.299,00€**



KG 800 PORTATA
STATICA

| CODICE | | | €/LISTINO | €/PROMO |
|---------------|---------------|---------------|-----------|----------|
| FG 100V/AS230 | FG 100B/AS230 | FG 100R/AS230 | 3.348,00 | 1.299,00 |

2°CASSETTO

- **FG 100/17E:** Modulo 65 utensili da 1/4"
- **FG 100/21TX:** Modulo 44 utensili con impronta Torx
- **FG 100/21B:** Modulo chiavi a bussola esagonali 1/2" 8-32mm + acc.



4°CASSETTO

- **FG 100/39C:** Modulo 3 pinze assortite
- **FG 100/45E:** Modulo 8 giraviti ad intaglio e a croce phillips
- **FG 100/45I:** Modulo 6 giraviti con impronta TORX



1°CASSETTO

- **FG 100/03G:** Modulo 14 chiavi combinate 6 - 19mm
- **FG 100/VA1:** Modulo di riempimento con vani porta minuteria
- **FG 100/03L:** Modulo 6 chiavi combinate



3°CASSETTO

- **FG 100/81F:** Modulo inserti a bussola da 1/2" esagonali e XZN
- **FG 100/23C:** Modulo 14 utensili a percussione da 1/2"
- **FG 100/56C:** Modulo utensili da percussione



5°CASSETTO

- **FG 100/10C:** Modulo 8 chiavi a T snodate esagonali





CARRELLI E BANCHI DA LAVORO

FG 104V/AS248

**CARRELLO PORTA UTENSILI FG 104
A 7 CASSETTI CON ASSORTIMENTO
248 UTENSILI IN MODULI DI GOMMA**

~~3.597,00€~~

1.499,00€



**PORTATA
STATICA**

| CODICE | | | | €/LISTINO | €/PROMO |
|---------------|---------------|---------------|---------------|---------------------|-----------------|
| FG 104V/AS248 | FG 104D/AS248 | FG 104B/AS248 | FG 104R/AS248 | 3.597,00 | 1.499,00 |

1°CASSETTO

- **FG 100/03G:** Modulo 14 chiavi combinate 6 - 19mm
- **FG 100/03L:** Modulo 6 chiavi combinate 21 - 32mm
- **FG 100/VA4:** Modulo di riempimento con vani porta minuteria
- **FG 100/21H:** Modulo 32 chiavi a bussola esagonali da 1/2" 8-32m + acc.



2°CASSETTO

- **FG 100/17E:** Modulo 65 utensili da 1/4"
- **FG 100/21TX:** Modulo 44 utensili con impronta Torx
- **FG 100/81F:** Modulo inserti a bussola da 1/2" esagonali e XZN
- **FG 100/23C:** Modulo 20 chiavi a bussola rinforzate da 1/2"



3°CASSETTO

- **FG 100/42C:** Modulo 4 pinze per anelli elastici 19-60mm
- **FG 100/39C:** Modulo 3 pinze
- **FG 100/45E:** Modulo 8 giraviti ad intaglio e a croce Phillips
- **FG 100/45I:** Modulo 6 giraviti con impronta Torx



4°CASSETTO

- **FG 100/65B:** Modulo pinza autobloccante e pinza regolabile a cerniera
- **FG 100/10D:** Modulo 12 chiavi a T snodate esagonali

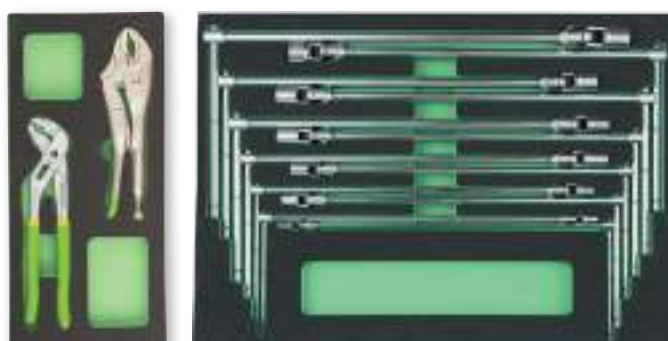



FG 160V/AS304

**CARRELLO PORTA UTENSILI A 14 CASSETTI
MOD. FG 160 CON ASSORTIMENTO
304 UTENSILI IN MODULI DI GOMMA**

~~5.470,50€~~ **2.699,00€**



KG 2.400 **PORTATA STATICA**

| CODICE | | | €/LISTINO | €/PROMO |
|---------------|---------------|---------------|-----------|----------|
| FG 160B/AS304 | FG 160R/AS304 | FG 160D/AS304 | 5.470,50 | 2.699,00 |

6 CASSETTI COMPLETI DI UTENSILI



- **FG 100/03G:** Modulo 14 chiavi combinate 6 - 19mm
- **FG 100/03L:** Modulo 6 chiavi combinate 21 - 32mm
- **FG 100/21H:** Modulo 32 chiavi a bussola esagonali da 1/2" 8-32mm + acc.
- **FG 100/17E:** Modulo 65 utensili da 1/4"
- **FG 100/21TX:** Modulo 44 utensili con impronta Torx
- **FG 100/VA4:** Modulo di riempimento con vani porta minuteria
- **FG 100/81F:** Modulo inserti a bussola da 1/2" esagonali e XZN
- **FG 100/23C:** Modulo 14 utensili a percussione da 1/2"

- **FG 100/48G:** Modulo 52 inserti da 10mm
- **FG 100/45I:** Modulo 6 giraviti con impronta TORX
- **FG 100/45T:** Modulo 6 giraviti a bussola esagonali
- **FG 100/45E:** Modulo 8 giraviti ad intaglio e a croce Phillips
- **FG 100/65B:** Modulo pinza autobloccante e pinza regolabile a cerniera aperta
- **FG 100/39C:** Modulo 3 pinze assortite
- **FG 100/50F:** Modulo 6 chiavi maschio esagonali con impugnatura
- **FG 100/10C:** Modulo 8 chiavi a T snodate 7-19mm



CARRELLI E BANCHI DA LAVORO



FG 100/03G

~~127,00€~~ 75,00€

MODULO 14 CHIAVI COMBinate

6, 7, 8, 9, 10, 11, 12, 13, 14, 15, 16, 17, 18, 19 mm



FG 100/03L

~~128,00€~~ 76,90€

MODULO 6 CHIAVI COMBinate

21, 22, 24, 27, 30, 32mm



FG 100/03E

~~75,00€~~ 45,90€

MODULO 8 CHIAVI A DOPPIA FORCHETTA

+ SET CHIAVI MASCHIO CON IMPRONTA ESAGONALE

6x7-20x22 mm + 139C/FS



FG 100/03F

~~79,00€~~ 48,50€

MODULO 5 CHIAVI A DOPPIA FORCHETTA

21x23, 24x26, 25x28, 27x29, 30x32 mm



FG 100/07C

~~85,00€~~ 49,90€

MODULO 7 CHIAVI DOPPIE POLIGONALI

6x7, 8x9, 10x11, 12x13, 14x15, 16x17, 18x19mm



FG 100/08C

~~200,00€~~ 119,00€

MODULO 8 CHIAVI COMBinate A CRICCO

8, 10, 11, 12, 13, 14, 15, 16, 17, 18, 19mm

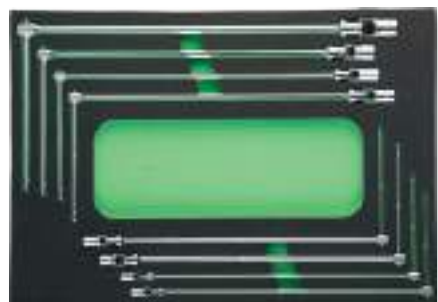

FG 100/10C

MODULO 8 CHIAVI A T SNODATE ESAGONALI

7, 8, 10, 11, 13, 14, 17, 19 mm

~~275,00€~~

169,00€

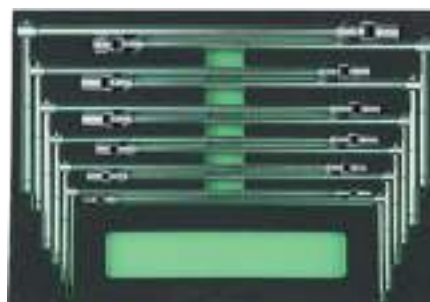

FG 100/10D

MODULO 12 CHIAVI A T SNODATE ESAGONALI

7, 8, 10, 11, 12, 13, 14, 15, 16, 17, 18, 19 mm

~~410,00€~~

249,00€



FG 100/17

~~115,00€~~ 69,90€

MODULO 18 UTENSILI DA 1/4"

4-14mm



FG 100/17E

~~255,00€~~ 152,50€

MODULO 65 UTENSILI DA 1/4"



FG 100/21B

MODULO 25 UTENSILI DA 1/2"
10-32mm ESAGONALI

~~220,00€~~ **129,90€**



FG 100/21C

MODULO 25 UTENSILI DA 1/2"
10-32mm POLIGONALI

~~220,00€~~ **129,90€**



FG 100/21M

MODULO 16 UTENSILI DA 1/2"
10-32mm ESAGONALI

~~150,00€~~ **89,90€**



FG 100/21D

MODULO 16 UTENSILI DA 1/2"
10-32mm POLIGONALI

~~150,00€~~ **89,90€**



FG 100/21H

MODULO 32 CHIAVI A BUSSOLA ESAGONALI 1/2" + ACCESSORI

BUSSOLE CORTE: 8-32mm
(esclusa 25mm)
BUSSOLE LUNGHE: 10-32mm

~~385,00€~~ **229,00€**



FG 100/21TX

MODULO 44 UTENSILI TORX

~~230,00€~~ **139,00€**



FG 100/81F

MODULO INSERTI A BUSSOLA DA 1/2" ESAGONALI XZN

~~320,00€~~ **149,00€**

FG 100/25

MODULO 9 UTENSILI DA 3/4"
34-50mm ESAGONALI

~~375,00€~~
229,00€



FG 100/25B

MODULO 9 UTENSILI DA 3/4"
34-50mm POLIGONALI

~~375,00€~~
229,00€



FG 100/23C

MODULO 20 UTENSILI RINFORZATI DA 1/2"

10, 11, 12, 13, 14, 15, 16, 17, 18, 19, 20, 21, 22, 23, 24, 25, 26, 27, 30, 32mm

~~200,00€~~ **122,50€**



FG 100/39C

MODULO 3 PINZE SOFT-RUN
FG 59SR/180, FG 61SR/160, FG 63SR/160

~~82,50€~~ **49,90€**



FG 100/65B

MODULO PINZA AUTOBLOCCANTE E PINZA REGOLABILE A CERNIERA APERTA

~~62,00€~~ **37,90€**



FG 100/41C

MODULO 4 PINZE PER ANELLI ELASTICI
Capacità: 8-25mm

~~95,00€~~ **57,90€**



FG 100/42C

MODULO 4 PINZE PER ANELLI ELASTICI
Capacità: 19-60mm

~~100,00€~~ **61,50€**



CARRELLI E BANCHI DA LAVORO

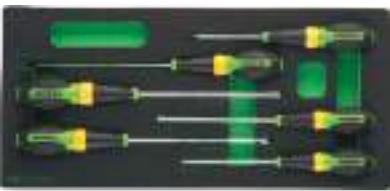

FG 100/45D

~~52,00€~~

31,90€

MODULO 6 GIRAVITI AD INTAGLIO E A CROCE PHILLIPS
3x100, 4x125, 5.5x150, 6.5x150, PH1x80, PH2x150

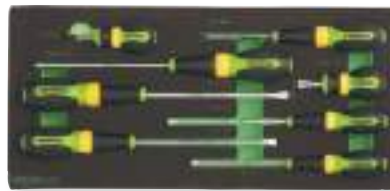

FG 100/45E

~~62,00€~~

37,90€

MODULO 8 GIRAVITI AD INTAGLIO E A CROCE PHILLIPS
3x100, 4x125, 5.5x150, 6.5x150, 6.5x38PH1x80, PH2x150, PH2x38

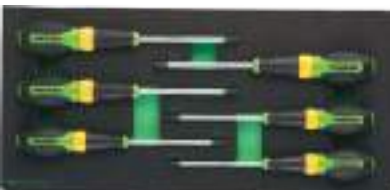

FG 100/45I

~~67,50€~~

39,90€

MODULO 6 GIRAVITI TORX
TX10, TX15, TX20, TX25, TX27, TX30

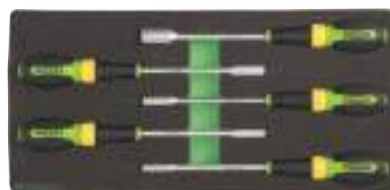

FG 100/45T

~~67,50€~~

39,90€

MODULO 5 GIRAVITI A BUSSOLA ESAGONALI
FX6, FX7, FX8, FX10, FX13



FG 100/48D

~~98,00€~~

59,90€

MODULO 40 INSERTI DA 1/4" + PORTA INSERTI

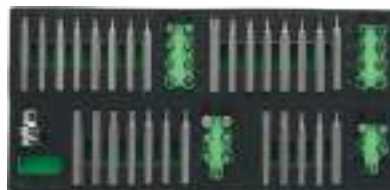

FG 100/48G

~~116,00€~~

69,90€

MODULO 52 INSERTI DA 10MM

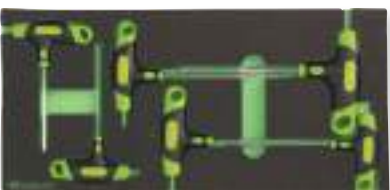

FG 100/50F

~~75,00€~~

45,90€

MODULO 6 CHIAVI MASCHIO ESAGONALI
2, 2.5, 3, 4, 5, 6mm

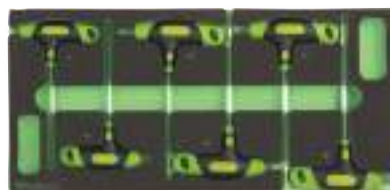

FG 100/50G

~~75,00€~~

45,90€

MODULO 6 CHIAVI MASCHIO TORX
TX10, TX15, TX20, TX25, TX27, TX30



FG 100/56

~~95,00€~~

56,90€

MODULO UTENSILI DA PERCUSSIONE



FG 100/56C

~~110,00€~~

65,90€

MODULO UTENSILI DA PERCUSSIONE
FG 132/500, FG 136/40, FG 126/SN1, FG 126/SN3



FG 107/A

NEW

CARRELLO PORTA ATTREZZI IN LAMIERA D'ACCIAIO

- Dimensione: 380x730x780mm
- 2 ruote fisse e 2 ruote girevoli con freno (Ø 100mm)
- Peso totale: 16.4Kg

~~180,00€~~

89,00€



MANIGLIONE LATERALE
IN LAMIERA D'ACCIAIO



4 RUOTE Ø 100MM
(2 GIREVOLI FRENANTI
E 2 FISSE)



RIPIANO CON BORDO RIALZATO
(PROFONDITA' 75MM)



FG 106/B

CARRELLO PORTA ATTREZZI IN LAMIERA D'ACCIAIO

- Dimensione: 460x930x885mm
- Lamiera d'acciaio 1.5mm
- Ruote montate su supporto rotante a piastra con gruppo rotante realizzato con doppia corona di sfere
- 2 ruote fisse, 1 girevole + 1 girevole con freno (Ø100mm)
- Peso totale: 22.0Kg

~~265,00€~~

159,00€

MADE IN ITALY



FG 106/C

CARRELLO PORTA ATTREZZI IN LAMIERA D'ACCIAIO - MOD. GIGANTE

- Dimensione: 560x1.000x950mm
- Lamiera d'acciaio 2.0mm
- Ruote montate su supporto rotante a piastra con gruppo rotante realizzato con doppia corona di sfere
- 2 ruote fisse, 1 girevole + 1 girevole con freno (Ø125mm)
- Peso totale: 44.0Kg

~~360,00€~~

179,00€

MADE IN ITALY



CARRELLI E BANCHI DA LAVORO

FG 129/1

**BANCO DA LAVORO 1.0MT
- SENZA CASSETTO**

Peso totale: 58Kg

Dimensione: 1.000x745x880 mm

~~437,00€~~

229,00€

MADE IN ITALY



FG 129/1.5

**BANCO DA LAVORO 1.5MT
- SENZA CASSETTO**

Peso totale: 77Kg

Dimensione: 1.500x745x880 mm

~~500,00€~~

269,00€

MADE IN ITALY



FG 129/2

**BANCO DA LAVORO 2.0MT
- SENZA CASSETTI**

Peso totale: 100Kg

Dimensione: 2.000x745x880 mm

~~635,00€~~

359,00€

MADE IN ITALY





MADE IN ITALY

~~520,00€~~

269,00€

FG 129/D1

BANCO DA LAVORO 1.0MT CON CASSETTI DI COLORE GRIGIO DARK

Peso totale: 64,50Kg

Dimensione: 1.000x745x880mm

FG 129/B1



FG 129/R1



MADE IN ITALY

~~625,00€~~

319,00€

FG 129/D1.5

BANCO DA LAVORO 1.5MT CON CASSETTI DI COLORE GRIGIO DARK

Peso totale: 83,50Kg

Dimensione: 1.500x745x880mm

FG 129/B1.5

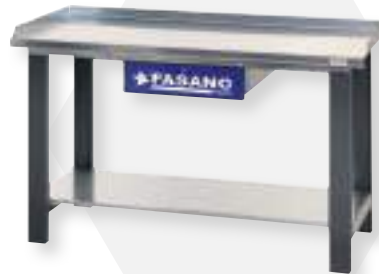

FG 129/R1.5



MADE IN ITALY

FG 129/D2

BANCO DA LAVORO 2MT CON CASSETTI DI COLORE GRIGIO DARK

Peso totale: 106,50Kg

Dimensione: 2.000x745x880mm

~~780,00€~~

429,00€

FG 129/B2



FG 129/R2





CARRELLI E BANCHI DA LAVORO



FG 131/D2

**BANCO DA LAVORO 2.0MT CON RIPIANO
IN ACCIAIO, CASSETTIERA 5 CASSETTI**

~~1.450,00€~~ **879,00€**

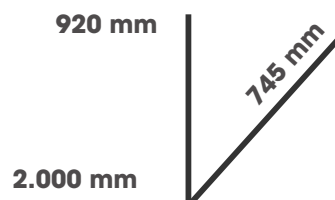

FG 131/R2

FG 131/B2

MADE IN ITALY



FG 132/D2

**BANCO DA LAVORO 2.0MT CON RIPIANO
IN ACCIAIO, 2 CASSETTIERE 5 CASSETTI**

~~2.000,00€~~ **1.199,00€**

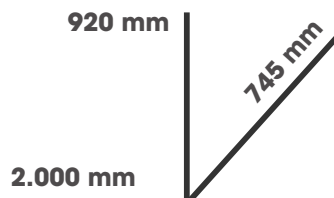

FG 132/R2

FG 132/B2

MADE IN ITALY



FG 134/D2

BANCO DA LAVORO 2.0MT CON RIPIANO IN ACCIAIO, CASSETTIERA 5 CASSETTI E PARETE PORTAUTENSILI

~~2.650,00€~~

1.599,00€

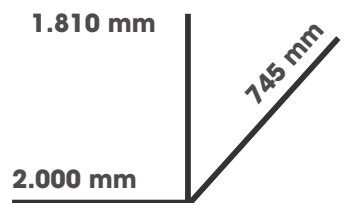

FG 134/R2

FG 134/B2

MADE IN ITALY



FG 135/D2

BANCO DA LAVORO 2.0MT CON RIPIANO IN ACCIAIO, 2 CASSETTIERE 5 CASSETTI E PARETE PORTAUTENSILI

~~3.200,00€~~

1.899,00€

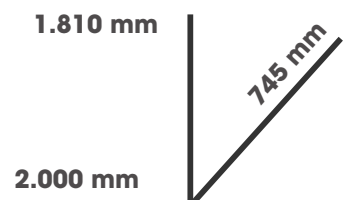

FG 135/R2

FG 135/B2

MADE IN ITALY



FG 133/D2

BANCO DA LAVORO 2.0MT CON CASSETTI E PARETE PORTAUTENSILI DI COLORE GRIGIO DARK

- Ripiano superiore in lamiera d'acciaio 3mm
- Ripiano inferiore in lamiera d'acciaio 3mm fornita di serie
- 2 cassetti dotati di sistema di chiusura con chiave
- Predisposizione per fissaggio a pavimento
- Struttura verniciata con vernice epossidica
- Parete portautensili con tapparella in alluminio e serratura

FG 133/R2

FG 133/B2

~~2.000,00€~~ **1.099,00€**

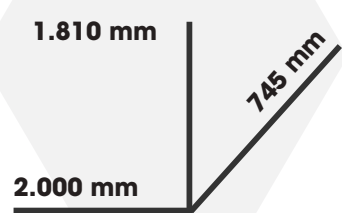
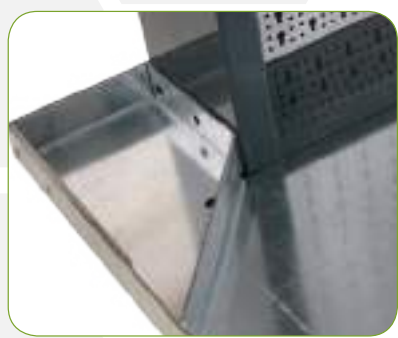

MADE IN ITALY



FG 137/D1.5

**BANCO DA LAVORO 1.5MT
CON VASCA DI RACCOLTA
DI COLORE GRIGIO DARK
E RUOTE GIREVOLI**

Peso totale: 90,00Kg
Dimensione: 1.500x745x880mm

~~1,230,00€~~ **699,00€**

RIPIANO MICRO FORATO



FG 137/R1.5

FG 137/B1.5



FG 131/A1

~~1,180,00€~~ **629,00€**

**BANCO DA LAVORO 1.0MT
- RIPIANO IN ACCIAIO INOX
E RUOTE GIREVOLI (2 FRENANTI)**

Dimensione: 1.000x750x920 mm



FG 131/D1

~~850,00€~~ **499,00€**

**BANCO DA LAVORO 1.0MT
- RIPIANO IN LAMIERA D'ACCIAIO
E RUOTE (2 FRENANTI)**

Dimensione: 1.000x750x920 mm



MODULAR FORMS

LA LINEA DI ARREDAMENTO TECNICO FASANO TOOLS OFFRE LA POSSIBILITÀ DI CREARE UN AMBIENTE DI LAVORO MODERNO, MODELLATO SUI TUOI SPAZI E SULLE TUE NECESSITÀ.

SCEGLI TRA UN'AMPIA GAMMA DI SOLUZIONI TUTTE ACCOMUNATE DA ELEVATI STANDARD QUALITATIVI E STUDIATE CON L'OBIETTIVO DI SFRUTTARE AL MEGLIO IL TUO SPAZIO DI LAVORO.



PERSONALIZZIAMO

IL COLORE DELLE COMPOSIZIONI
SECONDO I TUOI GUSTI
O IN BASE AI TUOI COLORI
AZIENDALI

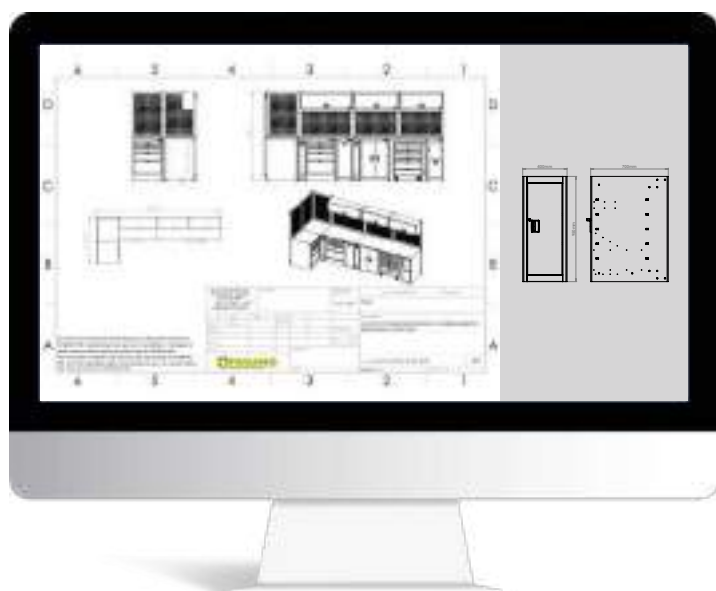

PROGETTIAMO

IL TUO AMBIENTE DI LAVORO IN BASE
AI TUOI SPAZI E ALLE TUE ESIGENZE

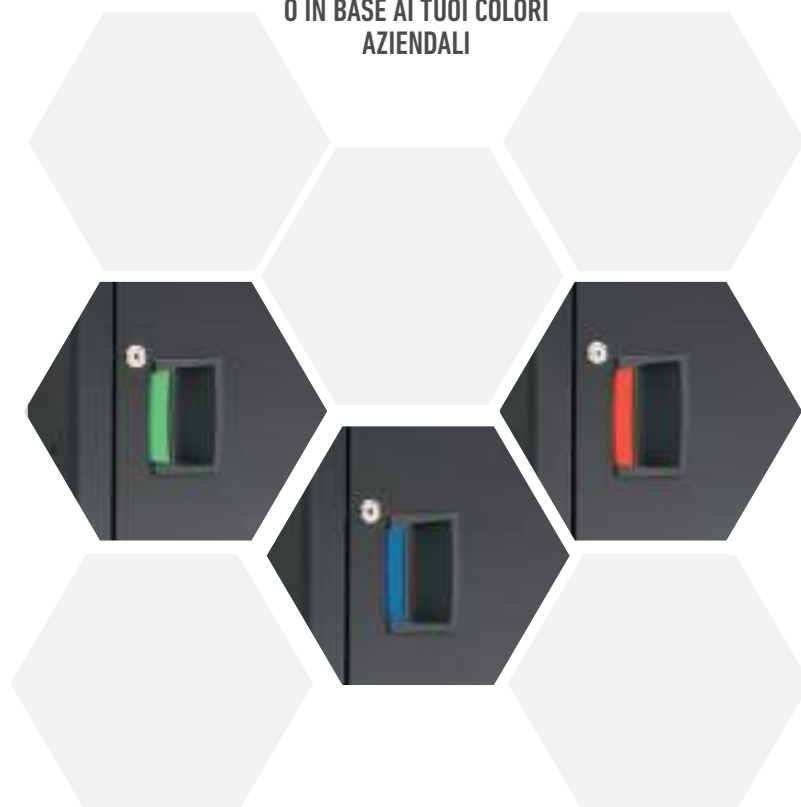



FG 118/AS119V

NEW

CONFIGURAZIONE ARREDAMENTO
TECNICO DA 2.050MM
CON ASSORTIMENTO UTENSILI

~~5.976,00€~~

2.999,00€



FG 118/AS119V



FG 118/AS119B



FG 118/AS119R

MADE IN ITALY

2.000 mm

757 mm

2.050 mm



ASSORTIMENTO 119PZ IN OMAGGIO

COMPOSIZIONE PARETE ATTREZZATA:

- FG 118V/69A: Modulo armadietto a 2 ante
- FG 118V/7T: Cassettiera mobile a 7 cassetti
- FG 118V/40F: Modulo porta carta, con cassetto porta rifiuti
- 02 pensili superiori dotati di pistoni a gas e serratura
- 02 griglie porta utensili
- 01 presa di corrente composta da 1 presa 220V a 2 poli, 1 presa Shuko a 2 poli cadauna, USB

CONTENUTO ASSORTIMENTO 119pz:

- FG 102/03G: Modulo 14 chiavi combinate 6 - 19mm
- FG 102/21E: Modulo chiavi a bussola 1/2" 8-32mm+acc.
- FG 102/17: Modulo chiavi a bussola 1/4" 4-14mm+acc.
- FG 102/39D: Modulo 3 pinze
- FG 102/48G: Modulo INSERTI CON ATTACCO 10mm
- FG 102/45F: Modulo 6 giraviti a taglio
- FG 102/45G: Modulo 6 giraviti a croce
- FG 102/65B: Modulo pinza autobloccante e pinza a cerniera
- FG 102/VA1: Modulo porta minuterie



RISPARMI OLTRE 600,00€ !

FG 118/C03V

CONFIGURAZIONE DI ARREDAMENTO TECNICO DA 2.050M DOTATA DI PENSILI SUPERIORI, GRIGLIE PORTA UTENSILI E ARMADIETTO LATERALE AD 1 ANTINA

Configurazione composta da:

- FG 118V/69A (Modulo armadietto a 2 antine)
- FG 118/69V7 (Cassettiera mobile a 7 cassetti)
- FG 118V/40F (Modulo porta carta dotato di cassetto porta rifiuti)
- FG 118/AR1V (Armadietto ad 1 antina)
- 02 pensili superiori dotati di pistoni a gas e serratura di chiusura
- 02 griglie porta utensili
- 02 prese di corrente composte da 1 presa 220V a 2 poli, 1 presa Shuko a 2 poli cadauna, USB



FG 118/C03B



FG 118/C03R

~~5.925,00€~~

3.199,00€

MADE IN ITALY

FG 118/C08V

CONFIGURAZIONE DI ARREDAMENTO TECNICO DA 1.220M DOTATA DI PENSILE SUPERIORE E GRIGLIA PORTA UTENSILI

Configurazione composta da:

- FG 118/69V7 (Cassettiera fissa a 7 cassetti)
- FG 118M/40F (Modulo porta carta, dotato di cassetto porta rifiuti)
- Pensile superiore dotato di pistoni a gas e serratura di chiusura
- 01 griglia porta utensili semplice
- 02 prese di corrente composte da 1 presa 220V a 2 poli, 1 presa Shuko a 2 poli cadauna, USB



FG 118/C08B



FG 118/C08R

~~3.400,00€~~

1.899,00€



MADE IN ITALY



FG 118/C020V

~~12.930,00€~~ **6.899,00€**

CONFIGURAZIONE DI ARREDAMENTO TECNICO DA 5.600M

Configurazione composta da:

- 04 pensili superiori dotati di pistoni a gas
- FG 118V/69A (Modulo armadietto a 2 antine)
- FG 118V/7T (Cassettiera mobile a 7 cassetti)
- FG 118V/40F (Modulo porta carta dotato di cassetto porta rifiuti)
- FG 118V/69E (Modulo porta rifiuti, dotato di contenitori)
- FG 118M/40D (Modulo distribuzione aria compressa)
- FG 118/69V7 (Cassettiera fissa a 7 cassetti)
- FG 118/AR1V (Armadietto laterale da 500mm)
- FG 118/AR3V (armadietto laterale con cassettiera interna)



FG 118/C020B



FG 118/C020R



FG 118/C021V

~~15.975,00€~~ **8.699,00€**

CONFIGURAZIONE DI ARREDAMENTO TECNICO COMPLETA DA 5.650MM

Configurazione composta da:

- 02 pensili superiori dotati di pistoni a gas
- 01 griglia porta utensili dotata di sistema di chiusura a tapparella
- FG 118V/69A (Modulo armadietto a 2 antine)
- FG 118V/7T (Cassettiera mobile a 7 cassetti)
- FG 118V/40F (Modulo porta carta dotato di cassetto porta rifiuti)
- FG 118M/69B (Modulo distribuzione olio, dotato di 2 pistole digitali conta litri)
- FG 118M/40D (Modulo distribuzione aria compressa)
- FG 118/69V7 (Cassettiera fissa a 7 cassetti)
- FG 118/AR1V (Armadietto laterale da 500mm)
- FG 118/AR3V (armadietto laterale da 1.000mm a 2 antine e cassettiera interna)



FG 118/C021B



FG 118/C021R

FG 118/C09V

CONFIGURAZIONE DI ARREDAMENTO TECNICO DA 2.050M

- Configurazione composta da:
- FG 118V/69E (Modulo porta rifiuti completo di contenitori interni)
 - FG 118M/40D (Modulo distribuzione aria compressa)
 - FG 118/69V7 (Cassettiera fissa a 7 cassetti)
 - 02 prese di corrente composte da 1 presa 220V a 2 poli, 1 presa Shuko a 2 poli cadauna, USB



FG 118/C09B

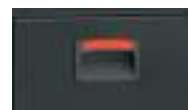

FG 118/C09R

MADE IN ITALY

~~5.025,00€~~

2.699,00€



FG 118/C010V

CONFIGURAZIONE DI ARREDAMENTO TECNICO DA 2.050M

- Configurazione composta da:
- FG 118V/69A (Modulo armadietto a 2 antine)
 - FG 118V/7T (Cassettiera mobile a 7 cassetti)
 - FG 118V/40F (Modulo porta carta, dotato di cassetto porta rifiuti)
 - 02 prese di corrente composte da 1 presa 220V a 2 poli, 1 presa Shuko a 2 poli cadauna, USB



FG 118/C010B



FG 118/C010R

MADE IN ITALY

~~4.805,00€~~

2.599,00€





PROFESSIONAL
EQUIPMENT



EQUIPMENT

NASCE UNA NUOVA GAMMA ALL'INTERNO DEL CATALOGO FASANO TOOLS:
L'EQUIPMENT PROFESSIONALE PER I SETTORI AUTOMOTIVE E
INDUSTRIA, FRUTTO DI UN ACCURATO LAVORO DI RICERCA E SVILUPPO,
CARATTERIZZATO DALLA SOLITA ATTENZIONE ALLA QUALITÀ E AI DETTAGLI.

FG 720/2T

NEW

**SOLLEVATORE IDRAULICO A CARRELLO 2 TON
- MODELLO CORTO E RIBASSATO**

~~440,00€~~

199,00€

Sistema di sollevamento ausiliario a pedale



Ruote in Nylon disponibili di ricambio



Sistema a doppio pistone



Contenitore porta minuterie integrato

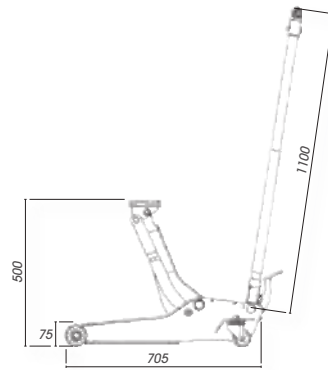

FG 722/2T

NEW

**SOLLEVATORE IDRAULICO A CARRELLO 2 TON
- MODELLO LUNGO E RIBASSATO**

~~530,00€~~

229,00€

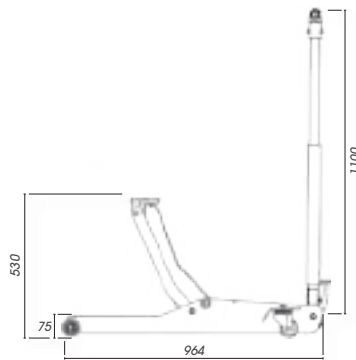

FG 722/5T

NEW

**SOLLEVATORE IDRAULICO A CARRELLO 5 TON
- MODELLO LUNGO PER MEZZI PESANTI**

~~1.190,00€~~

699,00€

Sistema di sollevamento ausiliario a pedale



Ruote in acciaio montate su cuscinetti a sfera

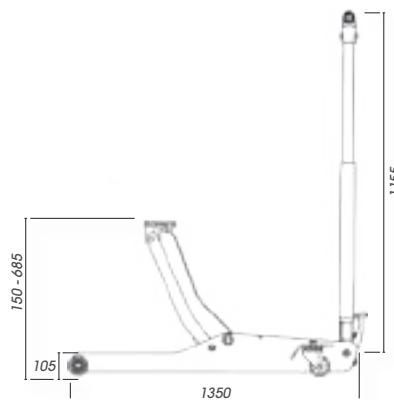

FG 725/...T

NEW

COLONNETTE DI SOSTEGNO



CE

| CODICE | CAPACITA' | H - MIN/MAX | €/PZ | €/PROMO |
|------------|-----------|-------------|--------|---------|
| FG 725/3T | 3 TON | 285-425MM | 76,00 | 39,90 |
| FG 725/6T | 6 TON | 390-605MM | 130,00 | 69,00 |
| FG 725/12T | 12 TON | 495-720MM | 230,00 | 119,00 |

FG 735/...T

NEW

SOLLEVATORI IDRAULICI A BOTTIGLIA



CE

| CODICE | CAPACITA' | H - MIN/MAX | STELO | €/PZ | €/PROMO |
|------------|-----------|-------------|-------|--------|---------|
| FG 735/4T | 4 TON | 193-373MM | 60MM | 70,00 | 39,90 |
| FG 735/6T | 6 TON | 214-416MM | 70MM | 82,00 | 42,90 |
| FG 735/10T | 10 TON | 230-460MM | 80MM | 115,00 | 59,90 |
| FG 735/16T | 16 TON | 230-440MM | 60MM | 130,00 | 69,90 |
| FG 735/20T | 20 TON | 242-452MM | 60MM | 170,00 | 89,90 |

FG 750/A

NEW

CARRELLO MOVIMENTAZIONE VEICOLI
- CAPACITÀ 680KG

~~340,00€~~

179,00€

CE



- Sistema di sollevamento a pedale
- Dotato di 4 ruote girevoli

FG 740/0.5T

NEW

SOLLEVATORE IDRAULICO DA FOSSA E SOTTOPONTE
- CAPACITÀ 500KG

~~530,00€~~

279,00€

- Sistema di sollevamento a pedale
- Dotato di 4 ruote girevoli



FG 748/0.5T

NEW

SUPPORTO SOSTEGNO MOTORE
- CAPACITÀ 500KG

~~210,00€~~

109,00€

CE

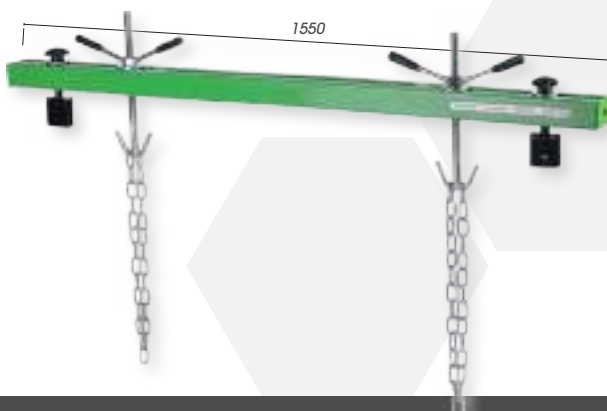



SICUREZZA TOTALE

Display digitale in grado di misurare la forza di compressione applicata



AFFIDABILITA'

Le griffe sono prodotte in acciaio forgiato e sono dotate di un incavo profondo per garantire una presa totale della molla senza rischi di alcun genere per l'utilizzatore



VELOCITA' D'USO

Lo speciale sistema autocentrante permette di posizionare i bracci con una sola mano e in modo rapido



PRECISIONE

La base d'appoggio inferiore, ottenuta in materiale gommoso, è dotata di bloccaggio a volantino e permette un posizionamento preciso dell'ammortizzatore

MADE IN ITALY



FG 750/1P

NEW

**SMONTA AMMORTIZZATORI
DOTATO DI 1 PISTONE**

Potenza spinta: 1.2 ton (10 bar) - 0.9 ton (8 bar)
Corsa di compressione molla: 300mm

~~2.250,00€~~

1.199,00€



FG 750/2P

NEW

**SMONTA AMMORTIZZATORI
DOTATO DI 2 PISTONI**

Potenza spinta: 2.4 ton (10 bar) - 1.9 ton (8 bar)
Corsa di compressione molla: 300mm

~~2.900,00€~~

1.499,00€



FG 752/1P

NEW

**SMONTA AMMORTIZZATORI
DOTATO DI 1 PISTONE E
DISPLAY DIGITALE**

Il display digitale visualizza la pressione applicata durante la fase di utilizzo

~~3.000,00€~~

1.499,00€



FG 752/2P

NEW

**SMONTA AMMORTIZZATORI
DOTATO DI 2 PISTONI E
DISPLAY DIGITALE**

Il display digitale visualizza la pressione applicata durante la fase di utilizzo

~~3.550,00€~~

1.799,00€

Coperture anti polvere rimovibili



Serie di cacciaspine in dotazione



Sistema di regolazione ad argano



Piastre a V, regolabili a 180°



CE

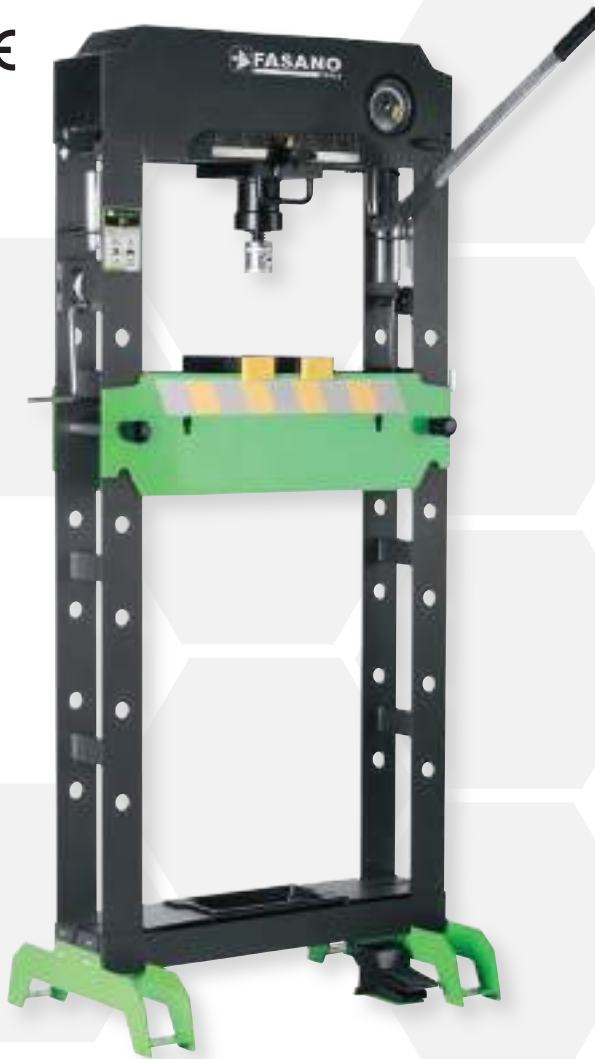

Manometro di facile lettura, integrato



Pistone mobile, con scala di misurazione



Speciale design per una maggiore regolabilità della base



Base d'appoggio rinforzata e dotata di contenitore porta minuterie



PRESSE IDRAULICHE

MANUALE

NEW

PRESSA IDRAULICA
MANUALE CON PISTONE
MOBILE E ARGANO

| CODICE | TON | €/LISTINO | €/PROMO |
|------------|--------|-----------|----------|
| FG 732/20T | 20 TON | 1.915,00 | 990,00 |
| FG 732/30T | 30 TON | 2.280,00 | 1.190,00 |

CE

PNEUMATICA

NEW

PRESSA IDRAULICA MANUALE
E PNEUMATICA CON PISTONE
MOBILE E ARGANO

| CODICE | TON | €/LISTINO | €/PROMO |
|-------------|--------|-----------|----------|
| FG 732/20TP | 20 TON | 2.235,00 | 1.169,00 |
| FG 732/30TP | 30 TON | 2.670,00 | 1.399,00 |
| FG 732/50TP | 50 TON | 3.950,00 | 2.099,00 |

CE



CE

FG 730/20T

NEW



PRESSA IDRAULICA MANUALE CON PISTONE FISSO

- Serie ECONOMY
- Base d'appoggio regolabile manualmente
- Manometro esterno, di facile lettura
- Struttura in acciaio



~~1.150,00€~~ **599,00€**

CE

FG 745/CMR

NEW

Sistema di rotazione a 360° a manovella



CAVALLETTO SOSTEGNO MOTORE RICHIUDIBILE

- Versione richiudibile
- Possibilità di rotazione a 360°
- Ruote in acciaio per una maggiore durata e portata

~~850,00€~~ **459,00€**

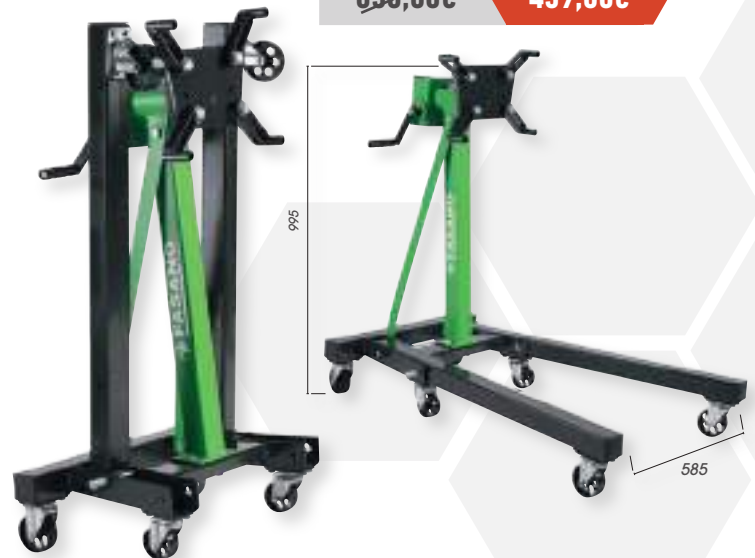

CE

Sistema di rotazione a 360°



FG 745/CMF

NEW

CAVALLETTO SOSTEGNO MOTORE

- Possibilità di rotazione a 360°
- Ruote in acciaio per una maggiore durata e portata

~~370,00€~~ **199,00€**

CE



FG 738/1T

NEW

GRU IDRAULICA PIEGHEVOLE CON POMPA A DOPPIO EFFETTO

- Capacità: 1 Ton
- Versione richiudibile
- Dotata di pompa a doppio effetto
- Ruote in acciaio per una maggiore durata e portata

~~960,00€~~ **499,00€**

FG 710/A



**LETTINO SOTTO MACCHINA
IN PASTICA ANTI-URTO**

Dimensioni: 1.020x450x90mm

**KG
136** PORTATA
STATICA

~~80,00€~~

42,50€

FG 710/B



**LETTINO SOTTO
MACCHINA RICHIUDIBILE**

Dimensioni da aperto: 910x415x120mm
Dimensioni da chiuso: 540x415x150mm

**KG
136** PORTATA
STATICA

~~95,00€~~

49,00€

FG 710/C

NEW

**SEGGIOLINO GIREVOLE,
DOTATO DI ACCESSORI**

~~135,00€~~

69,90€



FG 710/D

NEW

**SEGGIOLINO GIREVOLE,
DOTATO DI ACCESSORI**

~~220,00€~~

109,00€



FG 712/A

NEW

**PORTA MINUTERIE/UTENSILI
DOTATO DI RUOTE GIREVOLI**

- Dotato di 2 scomparti magnetici porta minuterie
- Dotato di 2 ampi scomparti porta utensili
- Dotato di piastra centrale magnetica
- 3 ruote girevoli da 500mm
- Materiale: ABS resistente agli urti

~~70,00€~~

35,90€



FG 700/OZ3.5

OZONIZZATORE 3.5 G/H - SERIE 700

- Sensore di saturazione: Sì
- Filtri a carboni attivi: Sì
- Stampante termica: No
- Case: Acciaio Inox
- Alimentazione: 12V e 220V
- Dimensioni: 335x200x160mm

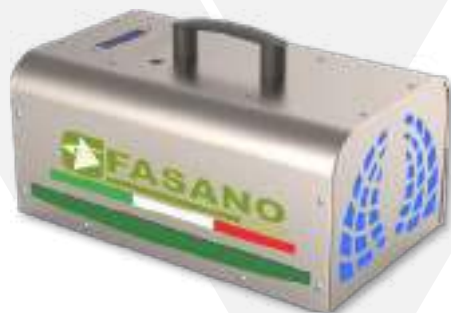

~~800,00€~~

399,00€

MADE IN ITALY

FG 702/OZ3.5

OZONIZZATORE 3.5 G/H - SERIE 702

- Sensore di saturazione: Sì
- Filtri a carboni attivi: Sì
- Stampante termica: Sì
- Case: Acciaio Inox
- Alimentazione: 12V e 220V
- Dimensioni: 335x200x160mm



~~900,00€~~

469,00€

MADE IN ITALY

FG 700/OZ5.0

OZONIZZATORE 5.0 G/H - SERIE 700

- Sensore di saturazione: Sì
- Filtri a carboni attivi: Sì
- Stampante termica: No
- Case: Acciaio Inox
- Alimentazione: 220V
- Dimensioni: 335x200x160mm

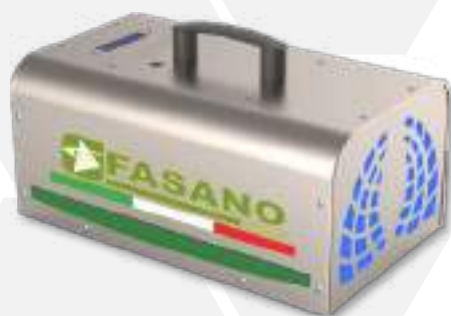

~~850,00€~~

439,00€

MADE IN ITALY

FG 702/OZ5.0

OZONIZZATORE 5.0 G/H - SERIE 702

- Sensore di saturazione: Sì
- Filtri a carboni attivi: Sì
- Stampante termica: Sì
- Case: Acciaio Inox
- Alimentazione: 220V
- Dimensioni: 335x200x160mm



~~950,00€~~

499,00€

MADE IN ITALY

FG 700/OZ10

OZONIZZATORE 10.0 G/H - SERIE 700

- Sensore di saturazione: Sì
- Filtri a carboni attivi: Sì
- Stampante termica: No
- Case: Acciaio Inox
- Alimentazione: 220V
- Dimensioni: 335x350x160mm

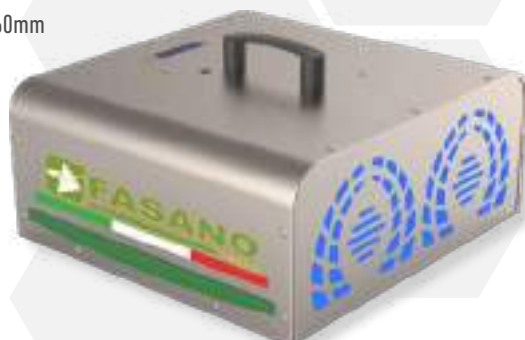

~~1.100,00€~~

579,00€

MADE IN ITALY

FG 702/OZ10

OZONIZZATORE 10.0 G/H - SERIE 702

- Sensore di saturazione: Sì
- Filtri a carboni attivi: Sì
- Stampante termica: Sì
- Case: Acciaio Inox
- Alimentazione: 220V
- Dimensioni: 335x350x160mm

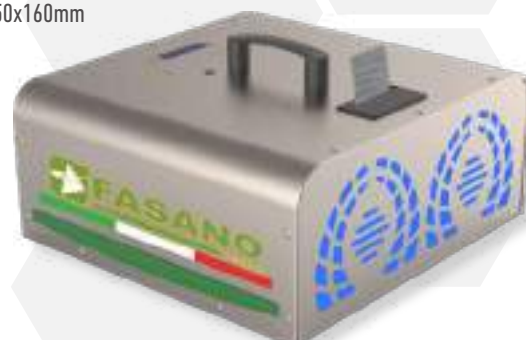

~~1.200,00€~~

639,00€

MADE IN ITALY

INDICE

| CODICE | PAGINA | €/Promo |
|--------------|--------|---------|
| FG 22/S6 | 16 | 17,90 |
| FG 22/S8 | 16 | 23,90 |
| FG 22/S8B | 16 | 25,90 |
| FG 22/S10 | 16 | 32,90 |
| FG 22/S12 | 16 | 45,90 |
| FG 22E/S6 | 21 | 29,90 |
| FG 22E/SZ6 | 21 | 29,90 |
| FG 22TX/S6 | 16 | 33,50 |
| FG 44/MT3 | 26 | 5,50 |
| FG 44/MT5 | 26 | 8,90 |
| FG 44/MT8 | 26 | 12,50 |
| FG 44/MT10 | 26 | 14,90 |
| FG 48/B | 25 | 11,50 |
| FG 48/L | 25 | 4,90 |
| FG 48/L9 | 25 | 3,90 |
| FG 48/LG | 25 | 4,90 |
| FG 49/MU | 25 | 12,50 |
| FG 49/TC | 25 | 19,90 |
| FG 49/TCX | 25 | 25,50 |
| FG 51/S4 | 18 | 48,50 |
| FG 51/S4B | 18 | 52,50 |
| FG 55/S4 | 18 | 69,50 |
| FG 55/S4B | 18 | 72,50 |
| FG 58/A240 | 17 | 19,90 |
| FG 59IS/S3 | 21 | 56,90 |
| FG 59PV/S3 | 18 | 35,90 |
| FG 59SR/S3 | 18 | 41,90 |
| FG 68U/S439 | 21 | 159,00 |
| FG 70/S110 | 24 | 179,00 |
| FG 75CO/S25 | 24 | 119,00 |
| FG 75HSS/S25 | 24 | 69,00 |
| FG 75TIN/S25 | 24 | 99,00 |
| FG 77/PVC4 | 25 | 39,00 |
| FG 78HSS/S12 | 24 | 119,00 |
| FG 86/S56 | 17 | 90,00 |
| FG 92/PF | 27 | 11,90 |
| FG 92/PM | 27 | 9,90 |
| FG 92/PM4 | 27 | 11,90 |
| FG 93/M50 | 27 | 16,90 |
| FG 93/M95 | 27 | 16,90 |
| FG 94/MI | 52 | 21,90 |
| FG 94/MS | 52 | 14,90 |
| FG 94/R | 62 | 10,90 |
| FG 94/T | 62 | 8,90 |
| FG 95/CA | 26 | 24,90 |
| FG 95/DG | 26 | 44,90 |
| FG 96/DG | 21 | 99,00 |
| FG 97/T1 | 26 | 139,00 |
| FG 97/T2 | 26 | 249,00 |
| FG 98/GAS | 30 | 62,90 |
| FG 98/LT | 30 | 139,00 |
| FG 99 | 53 | 259,00 |
| FG 99/B | 53 | 329,00 |
| FG 100/03E | 78 | 45,90 |
| FG 100/03F | 78 | 48,50 |
| FG 100/03G | 78 | 75,00 |
| FG 100/03L | 78 | 76,90 |
| FG 100/07C | 78 | 49,90 |
| FG 100/08C | 78 | 119,00 |
| FG 100/10C | 78 | 169,00 |
| FG 100/10D | 78 | 249,00 |

| CODICE | PAGINA | €/Promo |
|---------------|--------|----------|
| FG 100/17 | 78 | 69,90 |
| FG 100/17E | 78 | 152,50 |
| FG 100/21B | 79 | 129,90 |
| FG 100/21C | 79 | 129,90 |
| FG 100/21D | 79 | 89,90 |
| FG 100/21H | 79 | 229,00 |
| FG 100/21M | 79 | 89,90 |
| FG 100/21TX | 79 | 139,00 |
| FG 100/23C | 79 | 122,50 |
| FG 100/25 | 79 | 229,00 |
| FG 100/25B | 79 | 229,00 |
| FG 100/39C | 79 | 49,90 |
| FG 100/41C | 79 | 57,90 |
| FG 100/42C | 79 | 61,50 |
| FG 100/45D | 80 | 31,90 |
| FG 100/45E | 80 | 37,90 |
| FG 100/45I | 80 | 39,90 |
| FG 100/45T | 80 | 39,90 |
| FG 100/48D | 80 | 59,90 |
| FG 100/48G | 80 | 69,90 |
| FG 100/50F | 80 | 45,90 |
| FG 100/50G | 80 | 45,90 |
| FG 100/56 | 80 | 56,90 |
| FG 100/56C | 80 | 65,90 |
| FG 100/65B | 79 | 37,90 |
| FG 100/81F | 79 | 149,00 |
| FG 100B/5T | 60 | 489,00 |
| FG 100B/6T | 60 | 509,00 |
| FG 100B/7T | 60 | 529,00 |
| FG 100B/AS193 | 66 | 999,00 |
| FG 100B/AS226 | 73 | 1.099,00 |
| FG 100B/AS229 | 67 | 999,00 |
| FG 100B/AS230 | 75 | 1.299,00 |
| FG 100R/5T | 60 | 489,00 |
| FG 100R/6T | 60 | 509,00 |
| FG 100R/7T | 60 | 529,00 |
| FG 100R/AS193 | 66 | 999,00 |
| FG 100R/AS226 | 73 | 1.099,00 |
| FG 100R/AS229 | 67 | 999,00 |
| FG 100R/AS230 | 75 | 1.299,00 |
| FG 100V/5T | 60 | 489,00 |
| FG 100V/6T | 60 | 509,00 |
| FG 100V/7T | 60 | 529,00 |
| FG 100V/AS193 | 66 | 999,00 |
| FG 100V/AS226 | 73 | 1.099,00 |
| FG 100V/AS229 | 67 | 999,00 |
| FG 100V/AS230 | 75 | 1.299,00 |
| FG 101V/5G | 59 | 329,00 |
| FG 101V/6G | 59 | 349,00 |
| FG 101V/7G | 59 | 369,00 |
| FG 101V/AS190 | 63 | 799,00 |
| FG 102/03E | 68 | 39,90 |
| FG 102/03F | 68 | 45,00 |
| FG 102/03G | 68 | 69,90 |
| FG 102/03H | 68 | 129,00 |
| FG 102/03L | 68 | 72,90 |
| FG 102/07C | 68 | 45,90 |
| FG 102/07D | 68 | 66,90 |
| FG 102/08C | 68 | 115,00 |
| FG 102/10C | 68 | 149,00 |
| FG 102/13C | 68 | 85,00 |
| FG 102/17 | 68 | 59,90 |

| CODICE | PAGINA | €/Promo |
|---------------|--------|---------|
| FG 102/17E | 68 | 145,00 |
| FG 102/19 | 69 | 109,00 |
| FG 102/19B | 69 | 98,00 |
| FG 102/21B | 69 | 122,50 |
| FG 102/21C | 69 | 122,50 |
| FG 102/21D | 69 | 82,50 |
| FG 102/21E | 69 | 82,50 |
| FG 102/21H | 69 | 109,00 |
| FG 102/21R | 69 | 119,00 |
| FG 102/21TX | 69 | 125,00 |
| FG 102/23C | 69 | 65,00 |
| FG 102/25 | 69 | 199,00 |
| FG 102/25B | 69 | 199,00 |
| FG 102/39C | 69 | 42,90 |
| FG 102/39D | 69 | 36,90 |
| FG 102/41C | 70 | 49,90 |
| FG 102/42C | 70 | 54,90 |
| FG 102/45D | 70 | 22,90 |
| FG 102/45E | 70 | 29,50 |
| FG 102/45F | 70 | 26,90 |
| FG 102/45G | 70 | 24,90 |
| FG 102/45I | 70 | 32,90 |
| FG 102/45L | 70 | 33,90 |
| FG 102/45T | 70 | 34,50 |
| FG 102/45U | 70 | 43,90 |
| FG 102/48D | 71 | 49,90 |
| FG 102/48G | 71 | 65,50 |
| FG 102/50F | 71 | 39,90 |
| FG 102/50G | 71 | 39,90 |
| FG 102/51H | 69 | 62,50 |
| FG 102/56C | 71 | 58,90 |
| FG 102/60C | 71 | 21,00 |
| FG 102/62B | 71 | 41,50 |
| FG 102/62C | 71 | 41,50 |
| FG 102/65B | 71 | 29,90 |
| FG 102/PL | 62 | 31,50 |
| FG 102/PR | 62 | 33,90 |
| FG 102/VA1 | 71 | 7,90 |
| FG 102B/5G | 59 | 429,00 |
| FG 102B/6G | 59 | 469,00 |
| FG 102B/7G | 59 | 499,00 |
| FG 102B/8G | 59 | 519,00 |
| FG 102B/AS149 | 64 | 899,00 |
| FG 102B/AS158 | 65 | 949,00 |
| FG 102B/AS161 | 72 | 999,00 |
| FG 102D/5G | 59 | 429,00 |
| FG 102D/6G | 59 | 469,00 |
| FG 102D/7G | 59 | 499,00 |
| FG 102D/8G | 59 | 519,00 |
| FG 102D/AS149 | 64 | 899,00 |
| FG 102D/AS158 | 65 | 949,00 |
| FG 102D/AS161 | 72 | 999,00 |
| FG 102R/5G | 59 | 429,00 |
| FG 102R/6G | 59 | 469,00 |
| FG 102R/7G | 59 | 499,00 |
| FG 102R/8G | 59 | 519,00 |
| FG 102R/AS149 | 64 | 899,00 |
| FG 102R/AS158 | 65 | 949,00 |
| FG 102R/AS161 | 72 | 999,00 |
| FG 102V/5G | 59 | 429,00 |
| FG 102V/6G | 59 | 469,00 |
| FG 102V/7G | 59 | 499,00 |

| CODICE | PAGINA | €/Promo |
|---------------|--------|----------|
| FG 102V/8G | 59 | 519,00 |
| FG 102V/AS149 | 64 | 899,00 |
| FG 102V/AS158 | 65 | 949,00 |
| FG 102V/AS161 | 72 | 999,00 |
| FG 104B/6G | 61 | 559,00 |
| FG 104B/7G | 61 | 599,00 |
| FG 104B/AS248 | 76 | 1.499,00 |
| FG 104D/6G | 61 | 559,00 |
| FG 104D/7G | 61 | 599,00 |
| FG 104D/AS248 | 76 | 1.499,00 |
| FG 104R/6G | 61 | 559,00 |
| FG 104R/7G | 61 | 599,00 |
| FG 104R/AS248 | 76 | 1.499,00 |
| FG 104V/6G | 61 | 559,00 |
| FG 104V/7G | 61 | 599,00 |
| FG 104V/AS248 | 76 | 1.499,00 |
| FG 105B/5G | 61 | 599,00 |
| FG 105B/6G | 61 | 649,00 |
| FG 105B/7G | 61 | 679,00 |
| FG 105D/5G | 61 | 599,00 |
| FG 105D/6G | 61 | 649,00 |
| FG 105D/7G | 61 | 679,00 |
| FG 105R/5G | 61 | 599,00 |
| FG 105R/6G | 61 | 649,00 |
| FG 105R/7G | 61 | 679,00 |
| FG 105V/5G | 61 | 599,00 |
| FG 105V/6G | 61 | 649,00 |
| FG 105V/7G | 61 | 679,00 |
| FG 106/B | 81 | 159,00 |
| FG 106/C | 81 | 179,00 |
| FG 107/A | 81 | 89,00 |
| FG 111/A | 30 | 29,90 |
| FG 111/AS104 | 31 | 299,00 |
| FG 111/AS55 | 31 | 199,00 |
| FG 111/B | 30 | 35,90 |
| FG 111/C | 30 | 42,90 |
| FG 118/AS119B | 90 | 2.999,00 |
| FG 118/AS119R | 90 | 2.999,00 |
| FG 118/AS119V | 90 | 2.999,00 |
| FG 118/CO10B | 93 | 2.599,00 |
| FG 118/CO10R | 93 | 2.599,00 |
| FG 118/CO10V | 93 | 2.599,00 |
| FG 118/CO20B | 92 | 6.999,00 |
| FG 118/CO20R | 92 | 6.999,00 |
| FG 118/CO20V | 92 | 6.899,00 |
| FG 118/CO21B | 92 | 8.699,00 |
| FG 118/CO21R | 92 | 8.699,00 |
| FG 118/CO21V | 92 | 8.699,00 |
| FG 118/CO3B | 91 | 3.199,00 |
| FG 118/CO3R | 91 | 3.199,00 |
| FG 118/CO3V | 91 | 3.199,00 |
| FG 118/CO8B | 91 | 1.899,00 |
| FG 118/CO8R | 91 | 1.899,00 |
| FG 118/CO8V | 91 | 1.899,00 |
| FG 118/CO9B | 93 | 2.699,00 |
| FG 118/CO9R | 93 | 2.699,00 |
| FG 118/CO9V | 93 | 2.699,00 |
| FG 125/B400 | 49 | 13,50 |
| FG 126/P500 | 49 | 24,50 |
| FG 127/S1 | 26 | 23,90 |
| FG 128/S11 | 26 | 59,90 |
| FG 129/1 | 82 | 229,00 |

| CODICE | PAGINA | €/Promo |
|---------------|--------|----------|
| FG 129/1.5 | 82 | 269,00 |
| FG 129/2 | 82 | 359,00 |
| FG 129/B1 | 83 | 269,00 |
| FG 129/B1.5 | 83 | 319,00 |
| FG 129/B2 | 83 | 429,00 |
| FG 129/D1 | 83 | 269,00 |
| FG 129/D1.5 | 83 | 319,00 |
| FG 129/D2 | 83 | 429,00 |
| FG 129/R1 | 83 | 269,00 |
| FG 129/R1.5 | 83 | 319,00 |
| FG 129/R2 | 83 | 429,00 |
| FG 130/S10 | 54 | 289,00 |
| FG 131/A1 | 87 | 629,00 |
| FG 131/B2 | 84 | 879,00 |
| FG 131/D1 | 87 | 499,00 |
| FG 131/D2 | 84 | 879,00 |
| FG 131/R2 | 84 | 879,00 |
| FG 132/B2 | 84 | 1.199,00 |
| FG 132/D2 | 84 | 1.199,00 |
| FG 132/R2 | 84 | 1.199,00 |
| FG 133/B2 | 86 | 1.099,00 |
| FG 133/D2 | 86 | 1.099,00 |
| FG 133/R2 | 86 | 1.099,00 |
| FG 134/B2 | 85 | 1.599,00 |
| FG 134/D2 | 85 | 1.599,00 |
| FG 134/R2 | 85 | 1.599,00 |
| FG 135/B2 | 85 | 1.899,00 |
| FG 135/D2 | 85 | 1.899,00 |
| FG 135/R2 | 85 | 1.899,00 |
| FG 137/B1.5 | 87 | 699,00 |
| FG 137/D1.5 | 87 | 699,00 |
| FG 137/R1.5 | 87 | 699,00 |
| FG 138 | 17 | 27,90 |
| FG 138/BP | 17 | 29,90 |
| FG 138/M | 17 | 31,90 |
| FG 139 | 17 | 16,90 |
| FG 139/B | 17 | 7,90 |
| FG 139/C | 17 | 10,90 |
| FG 139/D | 17 | 9,90 |
| FG 139/E | 17 | 16,90 |
| FG 139/L | 17 | 19,90 |
| FG 139/LM | 17 | 25,90 |
| FG 139/S9 | 17 | 19,90 |
| FG 142/S9 | 17 | 59,90 |
| FG 143TX/S6 | 17 | 39,90 |
| FG 147H/S8 | 6 | 29,90 |
| FG 147PT/S6 | 6 | 34,90 |
| FG 147TX/S8 | 6 | 37,90 |
| FG 150D/5G | 60 | 519,00 |
| FG 150D/6G | 60 | 539,00 |
| FG 150D/7G | 60 | 559,00 |
| FG 150D/AS173 | 74 | 1.199,00 |
| FG 150H/S30 | 14 | 109,00 |
| FG 150M/S26 | 14 | 99,00 |
| FG 150R/5G | 60 | 519,00 |
| FG 150R/6G | 60 | 539,00 |
| FG 150R/7G | 60 | 559,00 |
| FG 150R/AS173 | 74 | 1.199,00 |
| FG 150TX/S11 | 13 | 85,00 |
| FG 150TX/S32 | 14 | 99,00 |
| FG 152/RTXS10 | 15 | 89,00 |
| FG 152RH/S9 | 15 | 65,00 |

| CODICE | PAGINA | €/Promo |
|---------------|--------|----------|
| FG 160B/14L | 62 | 1.499,00 |
| FG 160B/AS316 | 77 | 2.699,00 |
| FG 160D/14L | 62 | 1.499,00 |
| FG 160D/AS316 | 77 | 2.699,00 |
| FG 160R/14L | 62 | 1.499,00 |
| FG 160R/AS316 | 77 | 2.699,00 |
| FG 160V/14L | 62 | 1.499,00 |
| FG 160V/AS316 | 77 | 2.699,00 |
| FG 162/S3 | 32 | 169,00 |
| FG 163/S2B | 32 | 129,00 |
| FG 164/S3 | 49 | 89,00 |
| FG 165/1 | 32 | 153,50 |
| FG 165/2 | 32 | 189,00 |
| FG 165/3 | 32 | 279,00 |
| FG 165/HI | 32 | 529,00 |
| FG 165/IE1 | 33 | 169,00 |
| FG 165/IE2 | 33 | 409,00 |
| FG 165/MB1 | 33 | 89,00 |
| FG 165/MB2 | 33 | 175,00 |
| FG 165/S26 | 50 | 349,00 |
| FG 165/S7 | | 98,00 |
| FG 166/S28 | 50 | 229,00 |
| FG 166/S4 | 51 | 349,00 |
| FG 166/S4B | 51 | 399,00 |
| FG 166/S7 | 50 | 309,00 |
| FG 168/FS5 | 33 | 9,90 |
| FG 168/S25 | 33 | 72,50 |
| FG 168EP/S5 | 33 | 15,90 |
| FG 169/A44 | 50 | 29,90 |
| FG 169/BS | 50 | 61,50 |
| FG 169/BS1 | 50 | 57,90 |
| FG 169/BS3 | 50 | 57,90 |
| FG 172/AS2 | 52 | 57,50 |
| FG 172/AS2-A | 52 | 13,90 |
| FG 172/AS2-B | 52 | 27,90 |
| FG 172/AS2-C | 52 | 15,90 |
| FG 172/AS2-D | 52 | 17,90 |
| FG 172/CL | 53 | 26,90 |
| FG 172/PA | 52 | 32,90 |
| FG 172/TC | 53 | 29,90 |
| FG 172/TG | 52 | 27,90 |
| FG 174/F1 | 46 | 39,50 |
| FG 174/F2 | 46 | 39,50 |
| FG 174/SC | 46 | 57,90 |
| FG 175/FO74 | 43 | 24,00 |
| FG 175/FO74.5 | 43 | 24,00 |
| FG 175/FO84 | 43 | 29,90 |
| FG 175/FT3 | 46 | 42,00 |
| FG 175/HI | 43 | 29,90 |
| FG 175/S114 | 43 | 135,00 |
| FG 175/S30 | 43 | 99,00 |
| FG 175/S6 | 43 | 32,90 |
| FG 176/S13 | 44 | 219,00 |
| FG 178/S6 | 48 | 179,00 |
| FG 178/SF | 48 | 769,00 |
| FG 178/UF | 43 | 29,90 |
| FG 178SF/AD13 | 48 | 29,90 |
| FG 178SF/AD14 | 48 | 29,90 |
| FG 179/S16 | 47 | 79,00 |
| FG 180/S17 | 48 | 329,00 |
| FG 180/S38 | 48 | 359,00 |
| FG 181/C14 | 47 | 14,90 |

| CODICE | PAGINA | €/Promo |
|---------------|--------|----------|
| FG 181/S115 | 47 | 189,00 |
| FG 181/S130 | 47 | 149,00 |
| FG 182/S10 | 33 | 399,00 |
| FG 182/S14 | 33 | 119,00 |
| FG 182/S16 | 47 | 249,00 |
| FG 183/S5 | 47 | 58,90 |
| FG 186/AS | 55 | 19,90 |
| FG 186/S11 | 54 | 65,00 |
| FG 186/S3 | 54 | 5,50 |
| FG 186/S3B | 54 | 6,40 |
| FG 186/S5 | 54 | 49,00 |
| FG 186P/S5 | 54 | 16,90 |
| FG 187/K10 | 55 | 12,90 |
| FG 187/K130 | 55 | 149,00 |
| FG 187/PN | 55 | 138,00 |
| FG 187/S7 | 55 | 109,00 |
| FG 190/AD1 | 45 | 29,50 |
| FG 190/AD2 | 45 | 18,90 |
| FG 190/IP | 45 | 26,90 |
| FG 190/S21 | 46 | 169,00 |
| FG 190/S6B | 46 | 84,50 |
| FG 190/S8 | 45 | 79,00 |
| FG 190/VW | 45 | 49,90 |
| FG 191/S22 | 45 | 299,00 |
| FG 198/B9 | 49 | 8,90 |
| FG 198/S11 | 49 | 72,90 |
| FG 199/PF | 49 | 109,00 |
| FG 203/A | 44 | 11,90 |
| FG 203/BW1 | 44 | 17,90 |
| FG 203/FO1 | 44 | 17,90 |
| FG 203/FO2 | 44 | 17,90 |
| FG 203/OP1 | 44 | 17,90 |
| FG 203/S20 | 44 | 195,00 |
| FG 203/S7 | 44 | 83,90 |
| FG 203/TO1 | 44 | 17,90 |
| FG 206 | 28 | 25,90 |
| FG 207 | 28 | 29,90 |
| FG 208 | 28 | 129,00 |
| FG 210/A | 29 | 49,00 |
| FG 211 | 29 | 59,00 |
| FG 212 | 29 | 39,00 |
| FG 215 | 56 | 479,00 |
| FG 215/S40 | 56 | 799,00 |
| FG 219/S | 57 | 1.699,00 |
| FG 491/1500 | 45 | 39,90 |
| FG 491/200 | 45 | 17,90 |
| FG 491/AD1 | 45 | 24,90 |
| FG 491/AD2 | 45 | 27,90 |
| FG 491/AD550 | 44 | 69,00 |
| FG 491/DF1500 | 44 | 72,50 |
| FG 531 | 22 | 99,00 |
| FG 533/2 | 22 | 112,50 |
| FG 536/1 | 22 | 116,00 |
| FG 536/2 | 22 | 119,00 |
| FG 536/3 | 22 | 135,00 |
| FG 538/1 | 23 | 399,00 |
| FG 538/2 | 23 | 449,00 |
| FG 539/1 | 23 | 579,00 |
| FG 543/DG1 | 22 | 349,00 |

| CODICE | PAGINA | €/Promo |
|---------------|--------|---------|
| FG 543/DG2 | 22 | 365,00 |
| FG 544/1 | 23 | 139,00 |
| FG 544/2 | 23 | 119,00 |
| FG 544/3 | 23 | 129,00 |
| FG 544/4 | 23 | 149,00 |
| FG 547/DG | 23 | 92,50 |
| FG 580/A | 23 | 149,00 |
| FG 580/B | 23 | 199,00 |
| FG 600/SC16 | 2 | 109,00 |
| FG 600/SC17 | 2 | 92,50 |
| FG 600/SC25 | 2 | 169,00 |
| FG 600/ST9 | 2 | 49,90 |
| FG 602/ST7 | 2 | 22,90 |
| FG 602C/SP9 | 2 | 39,90 |
| FG 603/S28A | 20 | 439,00 |
| FG 603/S28B | 20 | 439,00 |
| FG 603/TA1 | 20 | 129,00 |
| FG 605/ST11-B | 4 | 109,00 |
| FG 605/ST9-B | 4 | 89,00 |
| FG 606/SP9 | 5 | 62,50 |
| FG 609A/S5 | 3 | 46,50 |
| FG 610FL/SP9 | 5 | 112,50 |
| FG 613/S9 | 3 | 79,00 |
| FG 615A/S6 | 5 | 69,00 |
| FG 617B/S5 | 5 | 64,90 |
| FG 618/S10 | 3 | 199,00 |
| FG 618/S7 | 3 | 129,00 |
| FG 618/S7B | 3 | 119,00 |
| FG 619H/S5 | 3 | 82,90 |
| FG 619TX/S8 | 3 | 156,00 |
| FG 620A/S5 | 5 | 45,00 |
| FG 621H/S8C | 4 | 75,00 |
| FG 621TX/S13 | 4 | 119,00 |
| FG 622A/S2 | 5 | 45,00 |
| FG 622A/S6 | 5 | 72,00 |
| FG 622H/S6 | 4 | 79,90 |
| FG 622H/S7 | 4 | 104,00 |
| FG 624/CR14 | 6 | 19,90 |
| FG 624/CR38 | 8 | 19,90 |
| FG 624/FR14 | 6 | 21,50 |
| FG 624/MCH | 6 | 17,90 |
| FG 624/MCR | 6 | 17,90 |
| FG 624/RT14 | 6 | 29,90 |
| FG 624/S18 | 7 | 59,90 |
| FG 624/S25 | 7 | 39,90 |
| FG 624/S45 | 7 | 99,00 |
| FG 624B/S16 | 8 | 79,90 |
| FG 624B/S80 | 8 | 135,00 |
| FG 624B/TXS10 | 8 | 69,90 |
| FG 625/CR12 | 15 | 24,90 |
| FG 625/FR12 | 15 | 29,90 |
| FG 625/RT12 | 15 | 39,00 |
| FG 625/S109 | 9 | 159,00 |
| FG 625/S110 | 12 | 239,00 |
| FG 625/S27 | 9 | 79,90 |
| FG 625LTX/S9 | 13 | 69,90 |
| FG 625TX/S13 | 13 | 89,90 |
| FG 625TX/S23 | 13 | 99,00 |
| FG 625TX/S9 | 13 | 39,90 |
| FG 627/S3 | 49 | 45,00 |
| FG 628/S10 | 15 | 49,90 |
| FG 629A/S15 | 15 | 289,00 |

WWW.FASANOTOOLS.COM

NEW



| CODICE | PAGINA | €/Promo |
|----------------|--------|----------|
| FG 629B/S15 | 15 | 289,00 |
| FG 700/OZ10 | 101 | 579,00 |
| FG 700/OZ3.5 | 101 | 399,00 |
| FG 700/OZ5.0 | 101 | 439,00 |
| FG 702/OZ10 | 101 | 639,00 |
| FG 702/OZ3.5 | 101 | 469,00 |
| FG 702/OZ5.0 | 101 | 499,00 |
| FG 710/A | 100 | 42,50 |
| FG 710/B | 100 | 49,00 |
| FG 710/C | 100 | 69,90 |
| FG 710/D | 100 | 109,00 |
| FG 712/A | 100 | 35,90 |
| FG 712/L4 | 27 | 79,00 |
| FG 720/2T | 95 | 199,00 |
| FG 722/2T | 95 | 229,00 |
| FG 722/5T | 95 | 699,00 |
| FG 725/12T | 96 | 119,00 |
| FG 725/3T | 96 | 39,90 |
| FG 725/6T | 96 | 69,00 |
| FG 730/20T | 99 | 599,00 |
| FG 732/20T | 98 | 990,00 |
| FG 732/20TP | 98 | 1.169,00 |
| FG 732/30T | 98 | 1.190,00 |
| FG 732/30TP | 98 | 1.399,00 |
| FG 732/50TP | 98 | 2.099,00 |
| FG 735/10T | 96 | 59,90 |
| FG 735/16T | 96 | 69,90 |
| FG 735/20T | 96 | 89,90 |
| FG 735/4T | 96 | 39,90 |
| FG 735/6T | 96 | 42,90 |
| FG 738/1T | 99 | 499,00 |
| FG 740/0.5T | 96 | 279,00 |
| FG 745/CMF | 99 | 199,00 |
| FG 745/CMR | 99 | 459,00 |
| FG 748/0.5T | 96 | 109,00 |
| FG 750/1P | 97 | 1.199,00 |
| FG 750/2P | 97 | 1.499,00 |
| FG 750/A | 96 | 179,00 |
| FG 752/1P | 97 | 1.499,00 |
| FG 752/2P | 97 | 1.799,00 |
| FG 800/9 | 47 | 79,00 |
| FG BEST 108 | 10 | 119,00 |
| FG BEST 171 | 11 | 159,00 |
| FG SERVICE 106 | 53 | 89,00 |
| FGA 291/B | 37 | 59,00 |
| FGA 292/B | 37 | 119,00 |
| FGA 302 | 35 | 119,00 |
| FGA 307 | 35 | 135,00 |
| FGA 307AN/S13 | 37 | 189,00 |
| FGA 309 | 35 | 159,00 |
| FGA 312 | 35 | 199,00 |
| FGA 316 | 36 | 399,00 |
| FGA 316/L | 36 | 449,00 |
| FGA 319 | 36 | 559,00 |
| FGA 319/L | 36 | 619,00 |
| FGA 321 | 36 | 559,00 |
| FGA 321/B | 36 | 589,00 |
| FGA 321/C | 37 | 599,00 |

| CODICE | PAGINA | €/Promo |
|------------------|--------|---------|
| FGA 330 | 39 | 149,00 |
| FGA 332 | 38 | 79,00 |
| FGA 332/AN | 38 | 96,00 |
| FGA 333 | 38 | 99,00 |
| FGA 333/AC | 38 | 119,00 |
| FGA 334 | 40 | 79,00 |
| FGA 334/AN | 40 | 99,00 |
| FGA 334/AN115 | 40 | 99,00 |
| FGA 334/L | 40 | 99,00 |
| FGA 335 | 39 | 99,00 |
| FGA 336 | 39 | 299,00 |
| FGA 337 | 39 | 69,00 |
| FGA 338 | 40 | 62,50 |
| FGA 338/AN | 40 | 92,50 |
| FGA 338/B | 40 | 89,00 |
| FGA 338/L | 40 | 89,00 |
| FGA 339 | 39 | 179,00 |
| FGA 339/B | 39 | 99,00 |
| FGA 339/B50-G120 | 39 | 7,20 |
| FGA 339/B50-G60 | 39 | 5,40 |
| FGA 339/B50-G80 | 39 | 6,00 |
| FGA 340 | 38 | 149,00 |
| FGA 340/B | 38 | 149,00 |
| FGA 342 | 41 | 109,00 |
| FGA 342/B | 38 | 159,00 |
| FGA 343/N10 | 41 | 119,00 |
| FGA 343/N20 | 41 | 149,00 |
| FGA 346/S4 | 41 | 99,00 |
| FGA 382/AR15 | 41 | 109,00 |
| FGA 384/AR15 | 41 | 129,00 |

VISITA IL NOSTRO NUOVO SITO WEB!

DISTRIBUTORE UFFICIALE

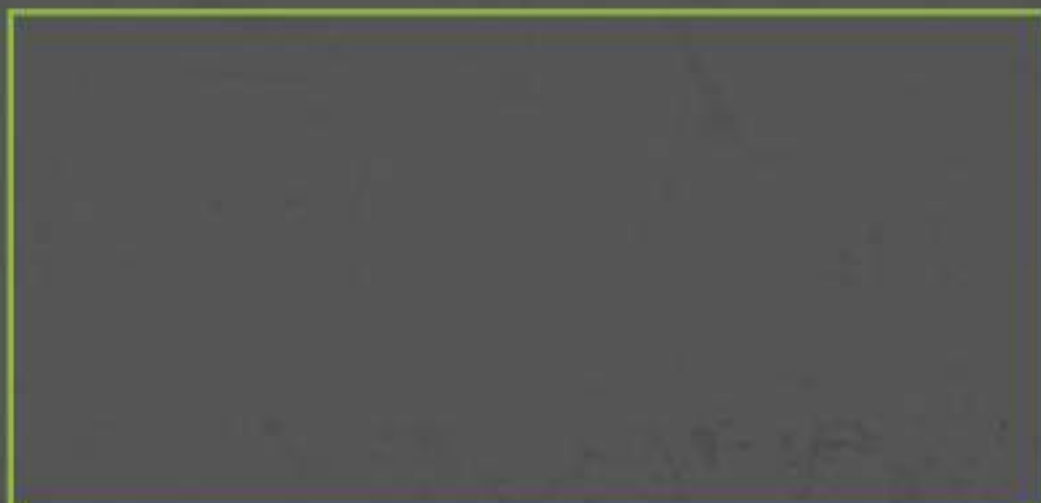

fasanotools.com

