

EMMERRE

spare parts for trucks and trailers



LINEA FRENANTE | BRAKE SYSTEM

2019

TECHNO
BRAKE



**LINEA ROBOTIZZATA PER
L'ASSEMBLAGGIO ED IL CONTROLLO
QUALITA' DEI MOZZI RUOTA COMPLETI
DI CUSCINETTI E RUOTE FONICHE**

Questa linea robotizzata è stata studiata e realizzata per assemblare i mozzi ruota con i relativi componenti in automatico tramite robot e presse di piantaggio.

Il robot con portata al polso di 350 kg gestisce la movimentazione dei mozzi ruota mentre il secondo robot gestisce la movimentazione di tutti i relativi componenti.

Tutta la linea robotizzata opera in completa autonomia tramite uno specifico software dedicato che comunica tutte le informazioni che necessitano (forze e quote di piantaggio). Al montaggio completato, il mozzo viene trasferito sull'unità di collaudo che va a verificare la coppia di rotolamento del mozzo per validare il prodotto.

Tale controllo qualità avviene al 100% dei mozzi assemblati. A qualità confermata il mozzo ruota viene poi marchiato per garantire la tracciabilità del prodotto stesso.

**ROBOTIC LINE TO ASSEMBLE AND
QUALITY TEST THE WHEEL HUBS WITH
BEARING AND ABS RING**

This robotic line has been studied and realized to automatically assemble wheel hubs with relative components by means of robot and pressing process.

The robot, with flow-rate strength 350 kg, manages the wheel hub movements while the second robot is dedicated to all the components movements.

The whole robotic line operates in complete autonomy by means of a specific dedicated software that communicates all the necessary information (power and pressing quota). When assembly is achieved, the hub is transferred to the test unit where the hub rolling torque is checked to validate the product.

This quality test is done on all the assembled hubs (100%)
The compliant hubs are marked in order to guarantee their traceability.

**LIGNE ROBOTISEE POUR
L'ASSEMBLAGE ET LE CONTROLE
QUALITE DES MOYEURS DE ROUE
COMPLETS DE ROULEMENT ET ABS**

Cette ligne robotisée a été étudiée et réalisée pour assembler automatiquement les moyeux de roue avec les différents composants par le biais de robot et de presses d'emboutissage. Le robot, avec force de portée de 350 kg, gère le déplacement des moyeux de roue tandis que le second robot gère le déplacement de tous les composants pertinents.

Toute la ligne robotisée fonctionne en parfaite autonomie grâce à un logiciel spécifique et dédié qui communique toutes les informations nécessaires (force et quota de pression). Al montage fait, le moyeu est transféré sur l'unité de contrôle qui vérifie les couples de frottement afin de valider le produit.

Ce contrôle est fait sur tous les moyeux assemblés (à 100%).
Le moyeu confirmé est marqué afin d'assurer que le produit soit traçable.



ROBOTISIERTE LINIE FÜR DIE MONTAGE UND QUALITÄTSKONTROLLE VON RADNABEN MIT LAGERN UND ABS

Esta robotizada línea fue diseñada para montar automáticamente los cubos de ruedas con los componentes rotacionales mediante robots y prensas eléctricas. El primer robot, con capacidad al pulso de 350 kg., gestiona el movimiento de los cubos de ruedas, mientras que el segundo robot controla el movimiento de todos los componentes ensamblados. Toda la línea robotizada funciona con total autonomía a través de un software específico dedicado que comunica toda la información que necesita (fuerzas impulsoras y cuotas). Una vez que se completa el ensamblaje, el cubo se transfiere a la unidad de prueba, que verifica los giros del cubo para validar el producto.

Diese Qualitätskontrolle erfolgt zu 100% der montierten Radnaben.

Wenn die Qualität konform ist, wird die Radnabe markiert, um die Rückverfolgbarkeit des Produktes selbst zu gewährleisten.

LÍNEA ROBOTIZADA PARA EL MONTAJE Y EL CONTROL DE CALIDAD DE LOS CUBOS DE RUEDA COMPLETOS CON RODAMIENTOS Y ABS RING

Esta línea robotizada ha sido diseñada y construida para ensamblar automáticamente los cubos de ruedas con los componentes rotacionales mediante robots y prensas eléctricas. El primer robot, con capacidad al pulso de 350 kg., gestiona el movimiento de los cubos de ruedas, mientras que el segundo robot controla el movimiento de todos los componentes ensamblados. Toda la línea robotizada funciona con total autonomía a través de un software específico dedicado que comunica toda la información que necesita (fuerzas impulsoras y cuotas). Una vez que se completa el ensamblaje, el cubo se transfiere a la unidad de prueba, que verifica los giros del cubo para validar el producto.

Este control de calidad se realiza al 100% de los cubos de rueda ensamblados. En cumplimiento a los más estrictos estándares de calidad establecidos, el cubo de rueda se marca para garantizar la trazabilidad del producto en el

РОБОТИЗИРОВАННАЯ ЛИНИЯ ПО СБОРКЕ И КОНТРОЛЮ КАЧЕСТВА КОЛЁСНЫХ СТУПИЦ В КОМПЛЕКТЕ С ПОДШИПНИКАМИ И КОЛЕСОМ ABS

Настоящая линия была разработана для автоматической сборки колёсных ступиц с соответствующими компонентами с использованием роботов и электромеханического оборудования. Один робот с пульсовой мощностью 350 кг управляет движением колёсных ступиц, другой робот управляет движением всех комплектующих деталей. Вся роботизированная линия функционирует в полной автономии посредством специальной программы, предназначенной для передачи всей необходимой информации (силы и параметры затрат). После завершения монтажа ступица перемещается в сектор проверки качества, где проверяются технические характеристики ступицы на соответствие установленным требованиям. Данный контроль качества проследит 100% собранных ступиц. Уместность колёсной ступицы затем подтверждается соответствующей маркировкой.

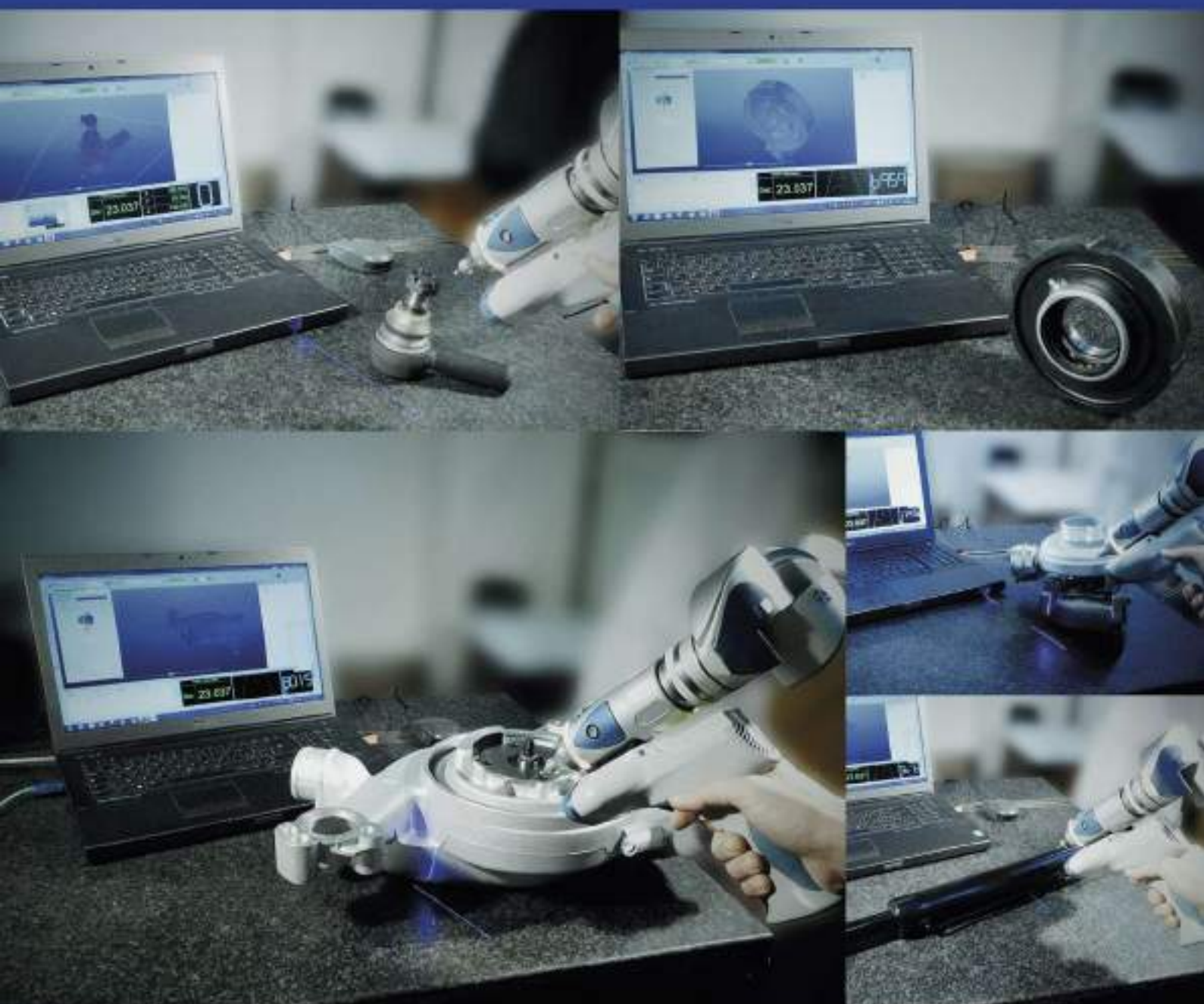

IL NOSTRO CONTROLLO QUALITA'

L'**innovazione tecnologica**, finalizzata al miglioramento continuo della **qualità del prodotto** e del servizio, rappresenta da sempre il tratto distintivo di **EMMERRE**.

I continui investimenti in **apparecchiature di ultima generazione** consentono di sviluppare e realizzare **prodotti innovativi** per soddisfare ogni esigenza del mercato. Molti prodotti sviluppati da **EMMERRE** sono coperti e tutelati da **BREVETTI nazionali ed internazionali**.

Dal 2016 il laboratorio di ricerca e sviluppo di **EMMERRE** è stato dotato della tecnologia avanzata della **scansione laser 3D**. Tramite la tecnologia della scansione laser 3D è possibile **ingegnerizzare** prodotti da "campioni" adottando, nel contempo, soluzioni tecniche innovative atte a migliorarne le caratteristiche. La tecnologia della **scansione laser 3D** consente inoltre di eseguire tutte le attività necessarie a **garantire la qualità del prodotto**: ispezioni, analisi dimensionali, verifiche di conformità, analisi dei quoti, ecc.

OUR QUALITY CONTROL

The **technological innovation** aimed to the continuous improvement of products and service **quality** is **EMMERRE** hallmark.

The continuous investments in **equipment of last generation** allow to develop and manufacture **innovative products** that answers the market requirements. Most of the parts that **EMMERRE** develops are protected by **national and international PATENTS**.

Since 2016 **EMMERRE** Research and Development laboratory has been equipped with a **3D laser scanner**. The 3D laser scanner allows the **reverse engineering** starting from a simple adopting new technical solutions to improve the parts characteristics. In addition the **3D scanner** technology allows to perform all the activities that **guarantee the product quality**: inspections, measurements, conformity, claim analysis and so on.

КОНТРОЛЬ КАЧЕСТВА

Техническая инновация, применяемая для постоянного улучшения качества продукции и сервисного обслуживания, как всегда представляет бренд **EMMERRE**.

Постоянные инвестиции в современное оборудование позволяют создавать и реализовывать новую продукцию, отвечающую требованиям рынка. Многие продукты, реализованные **EMMERRE**, имеют **ПАТЕНТЫ**, национального и международного уровня.

Начиная с 2016 года, отдел развития **EMMERRE** оснащен оборудованием высокой технологии - лазерное сканирование 3D. Благодаря технологии лазерного сканирования 3D возможно проектировать детали из «образцов», дополняя более современными техническими характеристиками. Технология лазерного сканирования 3D позволяет полностью гарантировать качество продукции: геометрическая проверка, контроль на соответствие размерам, поиск дефектов.

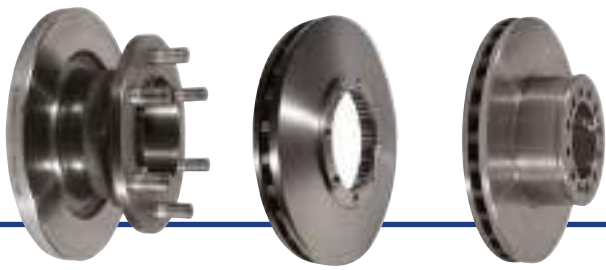

DISCHI FRENO | BRAKE DISCS

Dischi Freno
Brake Discs



TAMBURI FRENO | BRAKE DRUMS

Tamburi Freno
Brake Drums



MOZZI RUOTA | WHEEL HUBS

Mozzi Ruota
Wheel Hubs



PASTIGLIE FRENO | BRAKE PADS

Pastiglie Freno
Brake Pads

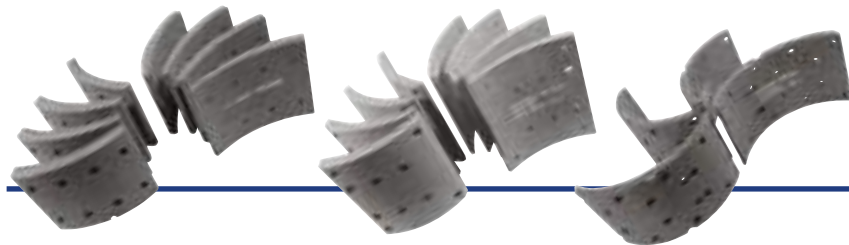

CEPPI FRENO | BRAKE LININGS

Ceppi Freno
Brake Linings

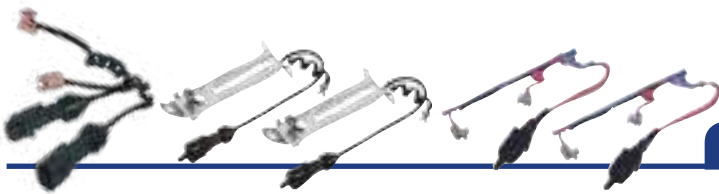

INDICATORI USURA | WEAR INDICATORS

Indicatori Usura
Wear Indicators

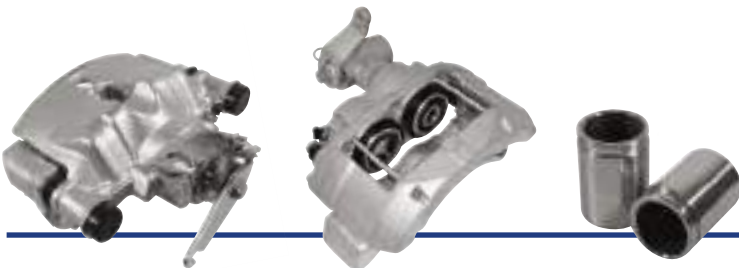

PINZE FRENO | BRAKE CALIPERS

Pinze Freno
Brake Calipers



MASSE FRENO | BRAKE ASSEMBLY

Masse Freno
Brake Assembly

E11

Dischi freno
Brake discs



E11

Ganasce
Brake shoes



E1 | E9

Ceppi freno
Brake linings

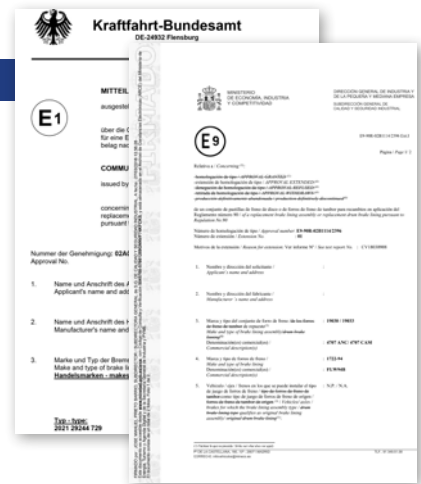

E3 | E1 | E11

Pastiglie freno
Brake pads

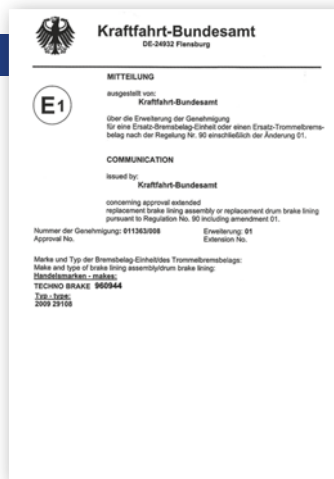

OMOLOGAZIONI

НОМОЛОГАЦИИ
ТРЕБОВАНИЯМ



DISCHI FRENO

BRAKE DISCS
DISQUES DE FREIN
BREMSSCHEIBEN
ТОРМОЗНЫЕ ДИСКИ
DISCOS DE FRENOS

NEWS

| Emmerre | Descrizione/Description | Adattabile/Adaptable to | Pagina/Page |
|---------------|---|-------------------------|--------------|
| 960573 | DISCO FRENO SENZA ABS - NS MODIFICA / BRAKE DISC WITHOUT ABS-OUR MODIFICATION | BPW | 4 |
| 960175 | DISCO FRENO POSTERIORE / REAR BRAKE DISC | FIAT | 11 |
| 960141 | DISCO FRENO POSTERIORE / REAR BRAKE DISC | FORD | 15 |
| 960142 | DISCO FRENO ANTERIORE / FRONT BRAKE DISC | FORD | 15 |
| 960143 | DISCO FRENO POSTERIORE / REAR BRAKE DISC | FORD | 15 |
| 960144 | DISCO FRENO ANTERIORE / FRONT BRAKE DISC | FORD | 16 |
| 960224 | DISCO FRENO POSTERIORE / REAR BRAKE DISC | IVECO-ROR | 32-70 |
| 960483 | DISCO FRENO ANTERIORE / FRONT BRAKE DISC | NISSAN-RENAULT | 49-66 |
| 960140 | DISCO FRENO POSTERIORE / REAR BRAKE DISC | RENAULT | 66 |
| 960579 | DISCO FRENO / BRAKE DISC | ROR | 70 |
| 960581 | DISCO FRENO / BRAKE DISC | ROR | 70 |
| 960608 | KIT FISSAGGIO DISCO FRENO / BRAKE DISC FIXING KIT | VOLVO | 83 |
| 960609 | KIT FISSAGGIO DISCO FRENO / BRAKE DISC FIXING KIT | VOLVO | 83 |

DISCHI FRENO
BRAKE DISCS
DISQUES DE FREIN
BREMSSCHEIBEN
ТОРМОЗНЫЕ ДИСКИ
DISCOS DE FRENOS

EMMERRE
spare parts for trucks and trailers

BPW

| Applicazioni / Applications | Dettagli / Detail | Adattabile a / Adaptable to | Emmerre |
|-----------------------------|---|-----------------------------|--|
| Trailer SK - SB | - Esterno/External Ø mm. 377 | 0308834040 |  960358 |
| SHZF - SKH | - Interno/Internal Ø mm. 290 | 0308834020 | |
| SKHBF-SKHBM | - Altezza fascia/Height band mm. 160 | 0308834060 | |
| SKHBMHLL | - Spessore/Thickness mm. 45 | 0308834047 | |
| SKHSF-SKHSM | - 10 Fori/Holes | 0308834067 | |
| SKHFA | - Con ABS/With ABS | | |
| SKHSMHLL | - Fascia autoventilata/Self-Ventilated Band | | |
| Eco Plus | - E11 90R - 02C01047/21144 | | |
| Eco Plus2 | - E11 90R - 02C01165/30217 | | |
| Eco Maxx | | | |

Connessione / Connected:  960948E3  960523

| | | | |
|-----------------|---|------------|---|
| Trailer SK - SB | - Esterno/External Ø mm. 377 | 0308834030 |  960360 |
| SHZF - SKH | - Interno/Internal Ø mm. 230 | 0308834037 | |
| SKHBF-SKHBM | - Altezza fascia/Height band mm. 160 | 0308834090 | |
| SKHBMHLL | - Spessore/Thickness mm. 45 | 0308834097 | |
| SKHSF-SKHSM | - 8 Fori/Holes | | |
| SKHFA | - Con ABS/With ABS | | |
| SKHSMHLL | - Fascia autoventilata/Self-Ventilated Band | | |
| Eco Plus2 | - E11 90R - 02C01047/21144 | | |
| Eco Maxx | - E11 90R - 02C01165/30217 | | |

Connessione / Connected:  960948E3  960523

| | | | |
|-------------|---|------------|--|
| Axle SKH | - Esterno/External Ø mm. 377 | 0308834010 |  960352 |
| SHZF - SKHB | - Interno/Internal Ø mm. 230 | 0308834017 | |
| SKHBF-SKHBM | - Altezza fascia/Height band mm. 160 | | |
| SKHBMHLL | - Spessore/Thickness mm. 45 | | |
| SKHSKHSF | - 8 Fori/Holes | | |
| SKHSKHSM | - 9/10 ton | | |
| SKHSKHZF | - Senza ABS/Without ABS | | |
| Eco Plus | - Fascia autoventilata/Self-Ventilated Band | | |
| Eco Plus 2 | | | |
| Eco Maxx | | | |

Connessione / Connected:  960948E3  960523

| | | | |
|-------------|--|------------|--|
| Trailer SKH | - Esterno/External Ø mm. 377 | 0308834070 |  960361 |
| Eco Plus | - Interno/Internal Ø mm. 222 | 0308834077 | |
| Eco Maxx | - Altezza fascia/Height band mm. 165 | | |
| | - Spessore/Thickness mm. 45 | | |
| | - 10 Fori/Holes | | |
| | - Senza ABS/Without ABS | | |
| | - Fascia autoventilata/Self-Ventilated Band | | |
| | - Omologazione E11/Homologation E11: E11 90R - 02C01047/21144 | | |

Connessione / Connected:  960948E3  960523

| Emmerre | Adattabile a / Adaptable to | Dettagli / Detail | Applicazioni / Applications |
|--|-----------------------------|---|---|
| 960359  | 0308834080 0308834087 | <ul style="list-style-type: none"> - Esterno/External Ø mm. 377 - Interno/Internal Ø mm. 290 - Altezza fascia/Height band mm. 170 - Spessore/Thickness mm. 45 <ul style="list-style-type: none"> - 10 Fori/Holes - Senza ABS/Without ABS - Fascia autoventilata/Self-Ventilated Band <ul style="list-style-type: none"> - E11 90R - 02C01047/21144 E11 90R - 02C01165/30217 | Trailer SKHB Eco Plus Eco Plus 2 Eco Maxx |
| | | Connessione / Connected:  960948E3  960523 | |
| 960575  | 0308834130 0308834137 | <ul style="list-style-type: none"> - Esterno/External Ø mm. 377 - Interno/Internal Ø mm. 293,80 - Altezza fascia/Height band mm. 159 - Spessore/Thickness mm. 45 <ul style="list-style-type: none"> - 10 Fori/Holes - Con ABS/With ABS - Fascia autoventilata/Self-Ventilated Band <ul style="list-style-type: none"> - E11 90R - 02C01047/21144 E11 90R - 02C01165/30217 | Trailer SK Eco Plus Eco Plus 2 Eco Eco Maxx |
| | | Connessione / Connected:  960994E3  960523-960529 | |
| 960570  | 0308834107 0308834100 | <ul style="list-style-type: none"> - Esterno/External Ø mm. 377 - Interno/Internal Ø mm. 293,50 - Altezza fascia/Height band mm. 160 - Spessore/Thickness mm. 45 <ul style="list-style-type: none"> - 10 Fori/Holes - Senza ABS/Without ABS - 9/10 Ton - Fascia autoventilata/Self-Ventilated Band <ul style="list-style-type: none"> - E11 90R - 02C01047/21144 E11 90R - 02C01165/30217 | Trailer SKH Eco Plus Eco Plus 2 Eco Maxx |
| | | Connessione / Connected:  960994E3  960523-960529 | |
| 960574  | 0308835010 0308835017 | <ul style="list-style-type: none"> - Esterno/External Ø mm. 430 - Interno/Internal Ø mm. 290 - Altezza fascia/Height band mm. 160 - Spessore/Thickness mm. 45 <ul style="list-style-type: none"> - 10 Fori/Holes - Con ABS/With ABS - Fascia autoventilata/Self-Ventilated Band <ul style="list-style-type: none"> - Omologazione E11/Homologation E11: E11 90R - 02C01047/26551 | Trailer SH - SB Eco Plus Eco Plus 2 Eco Maxx |
| | | Connessione / Connected:  960944E1-960944E3  960523 | |

EMMERRE
MODIFICATION

EMMERRE
MODIFICATION

EMMERRE
MODIFICATION

DISCHI FRENO
BRAKE DISCS
DISQUES DE FREIN
BREMSSCHEIBEN
ТОРМОЗНЫЕ ДИСКИ
DISCOS DE FRENOS

EMMERRE
spare parts for trucks and trailers

BPW

| Applicazioni / Applications | Dettagli / Detail | Adattabile a / Adaptable to | Emmerre |
|--|--|-------------------------------------|---------------|
| Trailer SH - SB Eco Plus Eco Plus 2 Eco Eco Maxx | <ul style="list-style-type: none"> - Esterno/External Ø mm. 430 - Interno/Internal Ø mm. 290 - Altezza fascia/Height band mm. 160 - Spessore/Thickness mm. 45 - 10 Fori/Holes - Senza ABS/Without ABS - Fascia autoventilata/Self-Ventilated Band - E11 90R - 02C01047/19596 - E11 90R - 02C01165/24552 | 0308835037 0308835030 MBR5047 | 960356 |



Connessione / Connected: 960944E1-960944E3 960523

| | | | |
|---|---|-------------------------------------|---------------|
| Trailer SB SH - SKH Eco Plus Eco Plus 2 Eco Eco Maxx | <ul style="list-style-type: none"> - Esterno/External Ø mm. 430 - Interno/Internal Ø mm. 293,50 - Altezza fascia/Height band mm. 160 - Spessore/Thickness mm. 45 - 10 Fori/Holes - Senza ABS/Without ABS - Fascia autoventilata/Self-Ventilated Band - E11 90R - 02C01047/19596 - E11 90R - 02C01165/24552 | 0308835050 0308835057 MBR5105 | 960571 |
|---|---|-------------------------------------|---------------|



Connessione / Connected: 960996E1-960996E3-960997E3 960523

| | | | |
|------------------------|--|-----------|---------------|
| 3° Axle Battagliano | <ul style="list-style-type: none"> - Esterno/External Ø mm. 430 - Interno/Internal Ø mm. 203 - Altezza fascia/Height band mm. 133 - Spessore/Thickness mm. 45 - 10 Fori/Holes - Senza ABS/Without ABS - Fascia autoventilata/Self-Ventilated Band - Omologazione E11/Homologation E11: - E11 90R - 02C01047/19596 | 040290000 | 960572 |
|------------------------|--|-----------|---------------|



Connessione / Connected: 960994E3 960523

| | | | |
|-----------------------|--|--------------------------|---------------|
| 3709TSB8-10 ton 8F | <ul style="list-style-type: none"> - Esterno/External Ø mm. 374 - Interno/Internal Ø mm. 230 - Altezza fascia/Height band mm. 159,50 - Spessore/Thickness mm. 45 - 8 Fori/Holes - Senza ABS/Without ABS - Fascia autoventilata/Self-Ventilated Band - Omologazione E11/Homologation E11: - E11 90R - 02C01047/21144 | 0308834167 0308834160 | 960576 |
|-----------------------|--|--------------------------|---------------|



| Emmerre | Adattabile a / <i>Adaptable to</i> | Dettagli / <i>Detail</i> | Applicazioni / <i>Applications</i> |
|--|---|---|---|
| <p>960573</p>  | <p>0308835120 0308835127 0308835128</p> | <p>- Esterno/<i>External</i> Ø mm. 430 - Interno/<i>Internal</i> Ø mm. 293,50 - Altezza fascia/<i>Height band</i> mm. 160 - Spessore/<i>Thickness</i> mm. 45 - 10 Fori/<i>Holes</i> - Senza ABS/<i>Without ABS</i> - Fascia autoventilata/<i>Self-Ventilated Band</i></p> | <p>TB54309 TB54312 SH Eco Plus 3 SKH Eco Plus 3</p> |
| | | | <p>Connessione / <i>Connected:</i>  970025</p> |

DISCHI FRENO
BRAKE DISCS
DISQUES DE FREIN
BREMSSCHEIBEN
ТОРМОЗНЫЕ ДИСКИ
DISCOS DE FRENOS

EMMERRE
spare parts for trucks and trailers

CARDI

| Applicazioni / Applications | Dettagli / Detail | Adattabile a / Adaptable to | Emmerre |
|---|---|-----------------------------|---------------|
| Mercedes Axle | <ul style="list-style-type: none"> - Esterno/External Ø mm. 377 - Interno/Internal Ø mm. 238 - Altezza fascia/Height band mm. 132 - Spessore/Thickness mm. 45 - 10 Fori/Holes - Fascia autoventilata/Self-Ventilated Band - E11 90R - 02C01047/21144 - E11 90R - 02C01165/30217 | 6754210012 | 960600 |
|  | | | |
| Connessione / Connected:  960948E3  960810 | | | |
| Mercedes Axle | <ul style="list-style-type: none"> - Esterno/External Ø mm. 430 - Interno/Internal Ø mm. 211 - Altezza fascia/Height band mm. 133 - Spessore/Thickness mm. 45 - 10 Fori/Holes - Fascia autoventilata/Self-Ventilated Band - Omologazione E11/Homologation E11: - E11 90R - 02C01047/19596 | -- | 960354 |
|  | | | |
| Connessione / Connected:  960944E1-960944E3  960523 | | | |

| Emmerre | Adattabile a / Adaptable to | Dettagli / Detail | Applicazioni / Applications |
|--|--|---|---|
| 960304  | AMPB889 MAK7429 MAK7529 RAK7404 PAK3545 RAK5412 | - Assale anteriore/ Front Axle - Esterno/External Ø mm. 315 - Interno/Internal Ø mm. 119 - Altezza fascia/Height band mm. 122 - Spessore/Thickness mm. 26 - 10 Fori/Holes - Fascia autoventilata/Self-Ventilated Band | FA 45 FA 500 FA 600 FA 700 FA 800 FA 900 FA 1000 FA 1100 |
| | Connessione / Connected:  960904 | | |
| 960303  | AMPB887 PAK3546 PAK5513 MAK2487 | - Assale anteriore/ Front Axle - Esterno/External Ø mm. 312 - Interno/Internal Ø mm. 133,5 - Altezza fascia/Height band mm. 137 - Spessore/Thickness mm. 30 - 12 Fori/Holes - Fascia autoventilata/Self-Ventilated Band - Omologazione E11/Homologation E11: E11 90R - 02C01165/30140 | FA 45 FA 1000 |
| | Connessione / Connected:  960904 | | |
| 960389  | AMPB860 AMPA014 NJK2785 | - Assale anteriore/ Front Axle - Esterno/External Ø mm. 375 - Interno/Internal Ø mm. 155 - Altezza fascia/Height band mm. 128 - Spessore/Thickness mm. 44 - 10 Fori/Holes - Fascia autoventilata/Self-Ventilated Band - Omologazione E11/Homologation E11: E11 90R - 02C01047/21144 E11 90R - 02C01165/30217 | F 50 FA 55 |
| | Connessione / Connected:  960904 | | |
| 960368  | 1408670 1408252 1400163 | - Assale anteriore/ Front Axle - Esterno/External Ø mm. 329 - Interno/Internal Ø mm. 117 - Altezza fascia/Height band mm. 123 - Spessore/Thickness mm. 34 - 12 Fori/Holes - Con ABS/With ABS - Fascia autoventilata/Self-Ventilated Band - Omologazione E11/Homologation E11: E11 90R - 02C01047/21145 | LF 45 |
| | Connessione / Connected:  960969E3  960801 | | |

DISCHI FRENO
BRAKE DISCS
DISQUES DE FREIN
BREMSSCHEIBEN
ТОРМОЗНЫЕ ДИСКИ
DISCOS DE FRENOS

EMMERRE
spare parts for trucks and trailers

Dischi Freno
Brake Discs

DAF

| Applicazioni / Applications | Dettagli / Detail | Adattabile a / Adaptable to | Emmerre |
|---|---|---|---------------|
| LF 45 | <ul style="list-style-type: none"> - Assale posteriore/Rear Axle - Esterno/External Ø mm. 330 - Interno/Internal Ø mm. 150 - Altezza fascia/Height band mm. 119 - Spessore/Thickness mm. 34 - 12 Fori/Holes - Con ABS/With ABS - Fascia autoventilata/Self-Ventilated Band - E11 90R - 02C01047/21145 - E11 90R - 02C01165/29061 | <p>1408672</p> <p>1408254</p> <p>1400273</p> | 960369 |
| Connessione / Connected:  960969E3  960801 | | | |
| LF 45 | <ul style="list-style-type: none"> - Assale anteriore/Front Axle - Esterno/External Ø mm. 330 - Interno/Internal Ø mm. 133 - Altezza fascia/Height band mm. 143 - Spessore/Thickness mm. 34 - 16 Fori/Holes - Con ABS/With ABS - Fascia autoventilata/Self-Ventilated Band - Omologazione E11/Homologation E11: - E11 90R - 02C01047/21145 | <p>1403758</p> <p>1408253</p> <p>1408671</p> | 960375 |
| Connessione / Connected:  960969E3-961041  960801 | | | |
| LF 55 | <ul style="list-style-type: none"> - Assale anteriore/Front Axle - Esterno/External Ø mm. 375 - Interno/Internal Ø mm. 117 - Altezza fascia/Height band mm. 99 - Spessore/Thickness mm. 45 - 10 Fori/Holes - Fascia autoventilata/Self-Ventilated Band - E11 90R - 02C01047/21144 - E11 90R - 02C01165/30217 | <p>1400069</p> <p>13162045</p> <p>NJK3571</p> | 960376 |
| Connessione / Connected:  960272E3  960551 | | | |
| LF 55 | <ul style="list-style-type: none"> - Assale posteriore/Rear Axle - Esterno/External Ø mm. 375 - Interno/Internal Ø mm. 179 - Altezza fascia/Height band mm. 146 - Spessore/Thickness mm. 45 - 10 Fori/Holes - Con ABS/With ABS - Fascia autoventilata/Self-Ventilated Band - E11 90R - 02C01047/21144 - E11 90R - 02C01165/30217 | <p>1400284</p> | 960377 |
| Connessione / Connected:  960272E3  960551 | | | |

I riferimenti indicati non sono originali ma perfettamente intercambiabili. I codici originali e le case costruttrici sono indicati a puro titolo informativo
The details described are not original but perfectly interchangeable. The original references and manufacturer names are given for information purposes only.

| Emmerre | Adattabile a / Adaptable to | Dettagli / Detail | Applicazioni / Applications |
|--|---|--|--|
| 960478 | 1703801 | <ul style="list-style-type: none"> - Assale anteriore/ Front Axle - Esterno/External Ø mm. 330 - Interno/Internal Ø mm. 95 - Altezza fascia/Height band mm. 113 - Spessore/Thickness mm. 34 - 10 Fori/Holes - Fascia autoventilata/Self-Ventilated Band - Omologazione E11/Homologation E11: E11 90R - 02C01047/21145 | LF 45 |
| 960213 | 1812563 1387439 1640561 1739542 1812582 1726138 1783346 | <ul style="list-style-type: none"> - Assale anteriore e posteriore Front and Rear Axle - Esterno/External Ø mm. 432 - Interno/Internal Ø mm. 217 - Spessore/Thickness mm. 45 - Fascia autoventilata/Self-Ventilated Band - Omologazione E11/Homologation E11: E11 90R - 02C01047/26548 E11 90R - 02C01165/27060 | CF 65 CF 75 LF 55 XF 95 XF 105 |
| Connessione / Connected:  960944E1-960944E3-960794E3  960523 | | | |



DISCHI FRENO
BRAKE DISCS
DISQUES DE FREIN
BREMSSCHEIBEN
ТОРМОЗНЫЕ ДИСКИ
DISCOS DE FRENOS

EMMERRE
spare parts for trucks and trailers

FIAT

| Applicazioni / Applications | Dettagli / Detail | Adattabile a / Adaptable to | Emmerre |
|--|--|--|---------------|
| Ducato Talento Peugeot J5 Citroen C25 | - Assale anteriore/ Front Axle - Esterno/External Ø mm. 256 - Interno/Internal Ø mm. 72 - Altezza fascia/Height band mm. 61 - Spessore/Thickness mm. 13 - 5 Fori/Holes - Fascia piena/Full band | 4450931 7568501 424685 424696 4246B3 ZF04450931 ZF07568501 | 960378 |



Connessione / Connected: 960862-960867

| | | | |
|--------------------------|---|----------------------------------|---------------|
| Ducato Citroen JUMPER | - Assale anteriore/ Front Axle - Esterno/External Ø mm. 280 - Interno/Internal Ø mm. 73 - Altezza fascia/Height band mm. 65,50 - Spessore/Thickness mm. 18 - 5 Fori/Holes - Fascia piena/Full band - Omologazione E11/Homologation E11: E11 90R - 02C01165/25155 | 71738910 1300500080 4246J9 | 960380 |
|--------------------------|---|----------------------------------|---------------|



Connessione / Connected: 960929-960935

| | | | | |
|-------------------|---|--|----------------------------------|---------------|
| Ducato Peugeot | - Assale anteriore/ Front Axle - Esterno/External Ø mm. 280 - Interno/Internal Ø mm. 73 - Altezza fascia/Height band mm. 65,50 - Spessore/Thickness mm. 24 - 5 Fori/Holes - Fascia autoventilata/Self-Ventilated Band - Omologazione E11/Homologation E11: E11 90R - 02C01165/36670 E11 90R - 02C01195/38098 | 51728377 1300501080 51848618 4246Y1 424927 4246X9 424926 | 51740244 46806233 71738905 | 960201 |
|-------------------|---|--|----------------------------------|---------------|



Connessione / Connected: 960929-960935

| | | | |
|---|--|---|---------------|
| Ducato Multijet Citroen Jumper Peugeot Boxer | - Assale anteriore/ Front Axle - Esterno/External Ø mm. 300 - Interno/Internal Ø mm. 80 - Altezza fascia/Height band mm. 65,50 - Spessore/Thickness mm. 24 - 5 Fori/Holes - Fascia autoventilata/Self-Ventilated Band - Omologazione E11/Homologation E11: E11 90R - 02C01165/30138 | 1307356080 -1341045080 51858362 - 51858363 51728378 - 51740247 4246K2 - 4246K3 4246Y3 4246Y5 424935 424936 71739637 46806234 | 960202 |
|---|--|---|---------------|



Connessione / Connected: 960929-960935-960428-960181E3-960182E3

| Emmerre | Adattabile a / Adaptable to | Dettagli / Detail | Applicazioni / Applications |
|--|--|---|--|
| 960183  | 51705749 51740246 51848620 51848621 424929 4249K2 424928 | <ul style="list-style-type: none"> - Assale anteriore/ Front Axle - Esterno/External Ø mm. 280 - Interno/Internal Ø mm. 73 - Altezza fascia/Height band mm. 70 - Spessore/Thickness mm. 28 - 5 Fori/Holes - Fascia autoventilata/Self-Ventilated Band - Omologazione E11/Homologation E11: E11 90R - 02C01195/39455 | Ducato 2006 Multijet Citroen Jumper Peugeot Boxer |
| | Connessione / Connected:  960181E3-960428 | | |
| 960185  | 51705758 51740249 424938 424937 | <ul style="list-style-type: none"> - Assale anteriore/ Front Axle - Esterno/External Ø mm. 300 - Interno/Internal Ø mm. 80 - Altezza fascia/Height band mm. 73,50 - Spessore/Thickness mm. 32 - 5 Fori/Holes - Fascia autoventilata/Self-Ventilated Band - Omologazione E11/Homologation E11: E11 90R - 02C01195/26089 | Ducato 2006 Multijet Citroen Jumper Peugeot Boxer |
| | Connessione / Connected:  960186E3-960428 | | |
| 960188  | 71740118 46833806 4246Y7 4246Y9 4249L0 | <ul style="list-style-type: none"> - Assale posteriore/ Rear Axle - Esterno/External Ø mm. 280 - Interno/Internal Ø mm. 72 - Altezza fascia/Height band mm. 82 - Spessore/Thickness mm. 16 - 5 Fori/Holes - Fascia piena/Full band - Omologazione E11/Homologation E11: E11 90R - 02C01165/24893 | Ducato 2008 JTD Citroen Jumper Peugeot Boxer |
| | Connessione / Connected:  960190 | | |
| 960189  | 71740117 46833807 4246Z1 4249E7 4249K9 | <ul style="list-style-type: none"> - Assale posteriore/ Rear Axle - Esterno/External Ø mm. 280 - Interno/Internal Ø mm. 79 - Altezza fascia/Height band mm. 82 - Spessore/Thickness mm. 16 - 5 Fori/Holes - Fascia piena/Full band - Omologazione E11/Homologation E11: E11 90R - 02C01165/24893 | Ducato 2008 JTD Citroen Jumper Peugeot Boxer |
| | Connessione / Connected:  960190 | | |

DISCHI FRENO
BRAKE DISCS
DISQUES DE FREIN
BREMSSCHEIBEN
ТОРМОЗНЫЕ ДИСКИ
DISCOS DE FRENOS

EMMERRE
spare parts for trucks and trailers

Dischi Freno
Brake Discs

FIAT

| Applicazioni / Applications | Dettagli / Detail | Adattabile a / Adaptable to | Emmerre |
|--|---|--|---------------|
| Ducato Multijet Citroen Peugeot | - Assale posteriore/Rear Axle - Esterno/External Ø mm. 280 - Interno/Internal Ø mm. 72 - Altezza fascia/Height band mm. 80 - Spessore/Thickness mm. 16 - 5 Fori/Holes - Fascia piena/Full band - Omologazione E11/Homologation E11: E11 90R - 02C01165/24893 | 51740245 51749274 424931 424930 | 960178 |



Connessione / Connected:  960173

| | | | |
|---|---|--|---------------|
| Ducato Multijet Citroen Jumper Peugeot Boxer | - Assale posteriore/Rear Axle - Esterno/External Ø mm. 280 - Interno/Internal Ø mm. 79 - Altezza fascia/Height band mm. 80 - Spessore/Thickness mm. 16 - 5 Fori/Holes - Fascia piena/Full band - Omologazione E11/Homologation E11: E11 90R - 02C01165/24893 | 51740248 51749275 424940 4246Z3 4246Z1 424939 | 960176 |
|---|---|--|---------------|



Connessione / Connected:  960173

| | | | |
|---|---|--|---------------|
| Ducato Multijet Citroen Jumper Peugeot Boxer | - Assale posteriore/Rear Axle - Esterno/External Ø mm. 300 - Interno/Internal Ø mm. 79 - Altezza fascia/Height band mm. 80 - Spessore/Thickness mm. 16 - 5 Fori/Holes - Fascia piena/Full band | 51740250 51749555 424942 4249K6 424941 | 960174 |
|---|---|--|---------------|



Connessione / Connected:  960173

| | | | |
|--|--|--|---------------|
| Ducato Multijet 130-150-180 Citroen Jumper Peugeot Boxer | - Assale posteriore/Rear Axle - Esterno/External Ø mm. 300 - Interno/Internal Ø mm. 79 - Altezza fascia/Height band mm. 80 - Spessore/Thickness mm. 22 - 5 Fori/Holes - Fascia autoventilata/Self-Ventilated Band | 51957512 51957511 1612435780 1612435880 | 960175 |
|--|--|--|---------------|



I riferimenti indicati non sono originali ma perfettamente intercambiabili. I codici originali e le case costruttrici sono indicati a puro titolo informativo
The details described are not original but perfectly interchangeable. The original references and manufacturer names are given for information purposes only.

Emmerre

Adattabile a / *Adaptable to*

Dettagli / *Detail*

Applicazioni / *Applications*

DISCHI FRENO
BRAKE DISCS
DISQUES DE FREIN
BREMSSCHEIBEN
ТОРМОЗНЫЕ ДИСКИ
DISCOS DE FRENOS

EMMERRE
spare parts for trucks and trailers

FORD

| Applicazioni / Applications | Dettagli / Detail | Adattabile a / Adaptable to | Emmerre |
|---|---|-------------------------------|---------------|
| Transit Wheels 14" - Autobus Van and Flat platform | - Assale anteriore/ Front Axle - Esterno/External Ø mm. 254 - Interno/Internal Ø mm. 78,5 - Altezza fascia/Height band mm. 43 - Spessore/Thickness mm. 24 - 5 Fori/Holes - Fascia autoventilata/Self-Ventilated Band | 5025610 5029815 1514234 | 960382 |



| Connessione / Connected:  960868-960869 | | | |
|--|---|-------------------------------|---------------|
| Transit Wheels 15" - Autobus Van and Flat platform | - Assale anteriore/ Front Axle - Esterno/External Ø mm. 270 - Interno/Internal Ø mm. 78,5 - Altezza fascia/Height band mm. 43 - Spessore/Thickness mm. 24 - 5 Fori/Holes - Fascia autoventilata/Self-Ventilated Band | 5025611 5029816 1514235 | 960383 |







| Connessione / Connected:  960868-960869 | | | |
|--|---|-------------------------------|---------------|
| Transit Autobus Van and Flat platform | - Assale anteriore/ Front Axle - Esterno/External Ø mm. 276 - Interno/Internal Ø mm. 82 - Altezza fascia/Height band mm. 43 - Spessore/Thickness mm. 24 - 5 Fori/Holes - Fascia autoventilata/Self-Ventilated Band | 4041427 4395257 1568654 | 960384 |



| Connessione / Connected:  960870E3 | | | |
|---|---|--|---------------|
| Transit Autobus Van and Flat platform | - Assale anteriore/ Front Axle - Esterno/External Ø mm. 294 - Interno/Internal Ø mm. 82 - Altezza fascia/Height band mm. 43 - Spessore/Thickness mm. 24 - 5 Fori/Holes - Fascia autoventilata/Self-Ventilated Band | 4041428 1387781 1568640 1738815 | 960385 |



| Emmerre | Adattabile a / Adaptable to | Dettagli / Detail | Applicazioni / Applications |
|---|--|---|---|
| 960466 | 1503287 1371393 1546747 | <ul style="list-style-type: none"> - Assale anteriore/ Front Axle - Esterno/External Ø mm. 300 - Interno/Internal Ø mm. 93,10 - Altezza fascia/Height band mm. 54,50 - Spessore/Thickness mm. 28 - 5 Fori/Holes - Fascia autoventilata/Self-Ventilated Band - Omologazione E11/Homologation E11: E11 90R - 02C01165/30138 | Transit Autobus Van and Flat platform |
|  | | | |
| 960386 | 4455980 4457985 4367104 4367106 1361298 1361300 | <ul style="list-style-type: none"> - Assale anteriore e posteriore Front and Rear Axle - Esterno/External Ø mm. 278 - Interno/Internal Ø mm. 63,50 - Altezza fascia/Height band mm. 44,50 - Spessore/Thickness mm. 24 - 5 Fori/Holes - Fascia autoventilata/Self-Ventilated Band - Omologazione E11/Homologation E11: E11 90R - 02C01195/38098 | Tourneo Connect Transit Connect |
|  | | | |
| 960465 | 1371394 1503290 1547061 | <ul style="list-style-type: none"> - Assale anteriore/ Front Axle - Esterno/External Ø mm. 280 - Interno/Internal Ø mm. 93 - Altezza fascia/Height band mm. 54,50 - Spessore/Thickness mm. 28 - 5 Fori/Holes - Fascia autoventilata/Self-Ventilated Band - Omologazione E11/Homologation E11: E11 90R - 02C01195/39455 | Transit Tourneo |
|  | | | |
| 960476 | 1371420 1464031 | <ul style="list-style-type: none"> - Assale posteriore/ Rear Axle - Esterno/External Ø mm. 280 - Interno/Internal Ø mm. 107,50 - Altezza fascia/Height band mm. 16 - Spessore/Thickness mm. 16 - 5 Fori/Holes - Fascia piena/Full band - Omologazione E11/Homologation E11: E11 90R - 02C01165/24893 | Transit Autobus Van and Flat platform |
|  | | | |

DISCHI FRENO
BRAKE DISCS
DISQUES DE FREIN
BREMSSCHEIBEN
ТОРМОЗНЫЕ ДИСКИ
DISCOS DE FRENOS

EMMERRE
spare parts for trucks and trailers

FORD

| Applicazioni / Applications | Dettagli / Detail | Adattabile a / Adaptable to | Emmerre |
|---|--|--|---------------|
| Transit Connect Tourneo Connect | <ul style="list-style-type: none"> - Assale posteriore/Rear Axle - Esterno/External Ø mm. 278 - Interno/Internal Ø mm. 63,50 - Altezza fascia/Height band mm. 54 - Spessore/Thickness mm. 11 - 5 Fori/Holes - Fascia piena/Full band | <ul style="list-style-type: none"> 1362867 1362868 4367107 4367108 4457989 4475316 | 960477 |
| Transit 2.0 TDCi Transit 2.2 TDCi 2012-2016 | <ul style="list-style-type: none"> - Assale posteriore/Rear Axle - Esterno/External Ø mm. 308 - Interno/Internal Ø mm. 96 - Altezza fascia/Height band mm. 69 - Spessore/Thickness mm. 16 - 5 Fori/Holes - Fascia piena/Full band | 1783910 | 960141 |
| Transit 2.0 TDCi Transit 2.2 TDCi 2012-2016 | <ul style="list-style-type: none"> - Assale anteriore/Front Axle - Esterno/External Ø mm. 308 - Interno/Internal Ø mm. 93,10 - Altezza fascia/Height band mm. 55,30 - Spessore/Thickness mm. 33 - 5 Fori/Holes - Fascia autoventilata/Self-Ventilated Band | <ul style="list-style-type: none"> 1842633 1763884 | 960142 |
| Transit 2.0 TDCi Transit 2.2 TDCi 2012-2016 | <ul style="list-style-type: none"> - Assale posteriore/Rear Axle - Esterno/External Ø mm. 288 - Interno/Internal Ø mm. 96 - Altezza fascia/Height band mm. 68,90 - Spessore/Thickness mm. 16 - 5 Fori/Holes - Fascia piena/Full band | 1764283 | 960143 |



| Emmerre | Adattabile a / Adaptable to | Dettagli / Detail | Applicazioni / Applications |
|---------------|-----------------------------|--|---|
| 960144 | 1763885 | <ul style="list-style-type: none"> - Assale anteriore/ Front Axle - Esterno/External Ø mm. 288 - Interno/Internal Ø mm. 93 - Altezza fascia/Height band mm. 55,40 - Spessore/Thickness mm. 33 - Fascia autoventilata/Self-Ventilated Band | Transit 2.0 TDCi Transit 2.2 TDCi 2012-2016 |



GASOLONE

| Emmerre | Adattabile a / Adaptable to | Dettagli / Detail | Applicazioni / Applications |
|---------------|-----------------------------|---|---------------------------------|
| 960243 | 60500015000 | <ul style="list-style-type: none"> - Assale anteriore/ Front Axle - Esterno/External Ø mm. 252 - Interno/Internal Ø mm. 72 - Altezza fascia/Height band mm. 70 - Spessore/Thickness mm. 13,50 - 4 Fori/Holes - Fascia piena/Full band | TS27 TS28 TSH35 TSHT35 |



Connessione / Connected: 960244E3

| | | | |
|---------------|-------------|--|---------------------------------|
| 960256 | 80500001043 | <ul style="list-style-type: none"> - Assale anteriore/ Front Axle - Esterno/External Ø mm. 262 - Interno/Internal Ø mm. 115,50 - Altezza fascia/Height band mm. 169 - Spessore/Thickness mm. 13,50 - 6 Colonnette/Bolts - Fascia piena/Full band - Omologazione E11/Homologation E11: E11 90R - 02C01165/25152 | TS27 TS28 TSH35 TSHT35 |
|---------------|-------------|--|---------------------------------|



Connessione / Connected: 960244E3





DISCHI FRENO
BRAKE DISCS
DISQUES DE FREIN
BREMSSCHEIBEN
ТОРМОЗНЫЕ ДИСКИ
DISCOS DE FRENOS

EMMERRE





spare parts for trucks and trailers

KÄSSBOHRER
BUS

Dischi Freno
Brake Discs

| Applicazioni / Applications | Dettagli / Detail | Adattabile a / Adaptable to | Emmerre |
|--|--|--|---------------|
| Evobus Setra Bus serie 100-200 Neoplan | <ul style="list-style-type: none"> - Assale anteriore/ Front Axle - Esterno/External Ø mm. 396 - Interno/Internal Ø mm. 194 - Altezza fascia/Height band mm. 119 - Spessore/Thickness mm. 48 - 10 Fori/Holes - Fascia autoventilata/Self-Ventilated Band | 056.101-00 179241111307 8284000147 8284000047 | 960313 |
| Connessione / Connected:  960961E3  960975 | | | |
| Setra Bus Kassbohrer Evobus Mercedes | <ul style="list-style-type: none"> - Assale anteriore/ Front Axle - Esterno/External Ø mm. 432 - Interno/Internal Ø mm. 194 - Altezza fascia/Height band mm. 135 - Spessore/Thickness mm. 45 - 10 Fori/Holes - Fascia autoventilata/Self-Ventilated Band - E11 90R - 02C01047/19596 - E11 90R - 02C01165/24552 | 8285390000 6274210012 | 960314 |
| Connessione / Connected:  960960E3  960976 | | | |



| Emmerre | Adattabile a / Adaptable to | Dettagli / Detail | Applicazioni / Applications |
|---|--|--|--|
| 960519 | 8973872290 8973718760 8971686311 | <ul style="list-style-type: none"> - Assale anteriore/ Front Axle - Esterno/External Ø mm. 293 - Interno/Internal Ø mm. 110 - Altezza fascia/Height band mm. 58 - Spessore/Thickness mm. 40 - 12 Fori/Holes - Fascia autoventilata/Self-Ventilated Band | NKR NPR NQR from 06/01 to 11/03 |
| Connessione / Connected:  960410 | | | |
| 960518 | 8970310071 897031007 | <ul style="list-style-type: none"> - Assale anteriore/ Front Axle - Esterno/External Ø mm. 265 - Interno/Internal Ø mm. 104 - Altezza fascia/Height band mm. 80 - Spessore/Thickness mm. 35 - 6 Fori/Holes - Fascia autoventilata/Self-Ventilated Band | NQR from 1994 to 12/98 |
| Connessione / Connected:  960410 | | | |
| 960520 | 8973872280 8981050580 8973718770 8971686321 | <ul style="list-style-type: none"> - Assale anteriore/ Front Axle - Esterno/External Ø mm. 310 - Interno/Internal Ø mm. 110 - Altezza fascia/Height band mm. 55,50 - Spessore/Thickness mm. 42 - 12 Fori/Holes - Fascia autoventilata/Self-Ventilated Band | NQR NPR from 01/2007 |
| Connessione / Connected:  960411-960410-960412 | | | |
| 960521 | 8970158571 8970158870 | <ul style="list-style-type: none"> - Assale anteriore/ Front Axle - Esterno/External Ø mm. 282 - Interno/Internal Ø mm. 110 - Altezza fascia/Height band mm. 62,50 - Spessore/Thickness mm. 35 - 12 Fori/Holes - Fascia autoventilata/Self-Ventilated Band | NQR NPR from 01/99 to 05/2001 |
| Connessione / Connected:  960411 | | | |

DISCHI FRENO
BRAKE DISCS
DISQUES DE FREIN
BREMSSCHEIBEN
ТОРМОЗНЫЕ ДИСКИ
DISCOS DE FRENOS

EMMERRE
spare parts for trucks and trailers

ISUZU

| Applicazioni / Applications | Dettagli / Detail | Adattabile a / Adaptable to | Emmerre |
|---|---|-----------------------------|---------------|
| N NKR NMR NPR | <ul style="list-style-type: none"> - Assale posteriore/Rear Axle - Esterno/External Ø mm. 275 - Interno/Internal Ø mm. 111 - Altezza fascia/Height band mm. 98,50 - Spessore/Thickness mm. 30 - 5 Fori/Holes - Fascia autoventilata/Self-Ventilated Band | 8980240060 | 960545 |
|  | | | |
| Connessione / Connected:  960408 | | | |

| Emmerre | Adattabile a / Adaptable to | Dettagli / Detail | Applicazioni / Applications |
|--|-----------------------------|--|---|
| 960021 960021S*  | 8582290 1904528 | <ul style="list-style-type: none"> - Assale anteriore/ Front Axle - Esterno/External Ø mm. 267 - Interno/Internal Ø mm. 58 - Altezza fascia/Height band mm. 154 - Spessore/Thickness mm. 14,2 <ul style="list-style-type: none"> - 6 Colonnelle/Bolts - Fascia piena/Full band - Omologazione E11/Homologation E11: E11 90R - 02C01165/25152 | Daily Restyling New Daily Turbodaily 30.8 30.10 |
| Connessione / Connected:  960913E3-960995 | | | |
| 960022 960022S*  | 93800492 1904529 | <ul style="list-style-type: none"> - Assale anteriore/ Front Axle - Esterno/External Ø mm. 267 - Interno/Internal Ø mm. 58 - Altezza fascia/Height band mm. 111 - Spessore/Thickness mm. 14,2 <ul style="list-style-type: none"> - 6 Colonnelle/Bolts - Fascia piena/Full band - Omologazione E11/Homologation E11: E11 90R - 02C01165/25152 | Daily Restyling New Daily Turbodaily 30/35/40.8 35/40.10 |
| Connessione / Connected:  960894E3-960898-960893E3-960892 | | | |
| 960023 960023S*  | 8584182 1904531 | <ul style="list-style-type: none"> - Assale anteriore/ Front Axle - Esterno/External Ø mm. 280 - Interno/Internal Ø mm. 58 - Altezza fascia/Height band mm. 142 - Spessore/Thickness mm. 16 <ul style="list-style-type: none"> - 6 Colonnelle/Bolts - Fascia piena/Full band - E11 90R - 02C01165/25155 E11 90R - 02C01165/24893 | Daily Restyling New Daily Turbodaily 35/45/49.10 35/49.12 |
| Connessione / Connected:  960900E3-960941E3 | | | |
| 960039 960039S*  | 98414402 1904693 | <ul style="list-style-type: none"> - Assale anteriore/ Front Axle - Esterno/External Ø mm. 290 - Interno/Internal Ø mm. 80 - Altezza fascia/Height band mm. 160,50 - Spessore/Thickness mm. 25 <ul style="list-style-type: none"> - 6 Colonnelle/Bolts - Fascia autoventilata/Self-Ventilated Band - Omologazione E11/Homologation E11: E11 90R - 02C01195/34315 | Turbodaily 59.12 |
| Connessione / Connected:  960974-960940 | | | |

* I codici Emmerre con finale S sono kit di 2 dischi freno/Emmerre's codes with final S are sets of 2 brake discs

DISCHI FRENO
BRAKE DISCS
DISQUES DE FREIN
BREMSSCHEIBEN
ТОРМОЗНЫЕ ДИСКИ
DISCOS DE FRENOS

EMMERRE
spare parts for trucks and trailers

IVECO

| Applicazioni / Applications | Dettagli / Detail | Adattabile a / Adaptable to | Emmerre |
|--|---|---|----------------------------------|
| Daily City 2000 26L9/L10/L11 L12/L13/L14 35C17 35S17 | - Assale anteriore/ Front Axle - Esterno/External Ø mm. 276 - Interno/Internal Ø mm. 73 - Altezza fascia/Height band mm. 72,5 - Spessore/Thickness mm. 22 - 5 Fori/Holes - Fascia piena/Full band - Omologazione E11/Homologation E11: E11 90R - 02C01165/25154 | 500306590 42470836 | 960923 960923S* |
| Connessione / Connected:  960910E3  960879-960864 | | | |
| Daily City 2000 29L9/10/11/12/13/14 | - Assale posteriore/Rear Axle - Esterno/External Ø mm. 276 - Interno/Internal Ø mm. 73 - Altezza fascia/Height band mm. 69,4 - Spessore/Thickness mm. 16 - 5 Fori/Holes - Fascia piena/Full band - Omologazione E11/Homologation E11: E11 90R - 02C01165/25153 | 7182299 2991646 | 960924 960924S* |
| Connessione / Connected:  960911E3  960979-960863 | | | |
| Daily City 2000 29L9/10/11/12/13/14 | - Assale posteriore/Rear Axle - Esterno/External Ø mm. 276 - Interno/Internal Ø mm. 73 - Altezza fascia/Height band mm. 69,5 - Spessore/Thickness mm. 16 - 5 Fori/Holes - Con ABS/With ABS - Fascia piena/Full band - Omologazione E11/Homologation E11: E11 90R - 02C01165/25153 | 7185410 42471034 2994066 7182300 | 960925 960925S* |
| Connessione / Connected:  960911E3  960979-960863 | | | |
| New Daily 96 Turbodaily 96 Daily City 2000 30/40/45.10 35/40/49/45.12 35.8 - 40C13 35C12/S12-35S9/C9 35S10-35S11/S13 35C10 50C11/C13/C15 | - Assale anteriore/ Front Axle - Esterno/External Ø mm. 290 - Interno/Internal Ø mm. 68 - Altezza fascia/Height band mm. 111 - Spessore/Thickness mm. 22 - 6 Colonnelle/Bolts - Fascia piena/Full band - E11 90R - 02C01165/24386 E11 90R - 02C01195/25347 | 93821918 42470842 1908772 | 960050 960050S* |
| Connessione / Connected:  960909E3-960992E3  960879-960864 | | | |

* I codici Emmerre con finale S sono kit di 2 dischi freno/Emmerre's codes with final S are sets of 2 brake discs

I riferimenti indicati non sono originali ma perfettamente intercambiabili. I codici originali e le case costruttrici sono indicati a puro titolo informativo
The details described are not original but perfectly interchangeable. The original references and manufacturer names are given for information purposes only.

EMMERRE

spare parts for trucks and trailers

IVECO

DISCHI FRENO
BRAKE DISCS
DISQUES DE FREIN
BREMSSCHEIBEN
ТОРМОЗНЫЕ ДИСКИ
DISCOS DE FRENOS

| Emmerre | Adattabile a / Adaptable to | Dettagli / Detail | Applicazioni / Applications |
|---|---|--|--|
| 960051 960051S*  | 7180256 42471111 1908773 500039186 | - Assale posteriore/Rear Axle - Esterno/External Ø mm. 289 - Interno/Internal Ø mm. 84 - Altezza fascia/Height band mm. 84,5 - Spessore/Thickness mm. 22 - 8 Fori/Holes - Fascia piena/Full band - Omologazione E11/Homologation E11: E11 90R - 02C01195/25834 | New Daily 96-Turbodaily 96 Daily City 2000 35/40/45/49.10 35/40/45/49.12 35.8-35C12/S12 35C14/S14/S13/C13 35C17/S17/S15/C15 3559/C9/S10/S11 40C13/15/14/17/18 50C11/13/14/15/17/18 35/40/50/65/70C21 |
| Connessione / Connected:  960909E3-960992E3  960879-960864 | | | |
| 960501 960501S*  | 504079365 42546401 504080994 | - Assale anteriore/Front Axle - Esterno/External Ø mm. 290 - Interno/Internal Ø mm. 64 - Altezza fascia/Height band mm. 110 - Spessore/Thickness mm. 22 - 6 Colonnelle/Bolts - Fascia piena/Full band - E11 90R - 02C01165/24386 E11 90R - 02C01195/25347 | Daily City 2000 35C12/14/17/15/9 35S9/10/11/13/15 40C13/14/15/17-40S17 50C11/15/13/14/17 |
| Connessione / Connected:  960502E3-960503E3-960504E3 | | | |
| 960107 960107S*  | 500322079 42471214 | - Assale anteriore/Front Axle - Esterno/External Ø mm. 290 - Interno/Internal Ø mm. 80 - Altezza fascia/Height band mm. 53 - Spessore/Thickness mm. 26 - 9 Fori/Holes - Fascia autoventilata/Self-Ventilated Band - E11 90R - 02C01165/30136 E11 90R - 02C01195/26088 | Daily City 2000 65C14/15/17 |
| Connessione / Connected:  960973E3  960879-960864 | | | |
| 960108 960108S*  | 7182874 42471150 | - Assale posteriore/Rear Axle - Esterno/External Ø mm. 306 - Interno/Internal Ø mm. 178,20 - Altezza fascia/Height band mm. 136,5 - Spessore/Thickness mm. 22 - 6 Fori/Holes - Fascia piena/Full band | Daily City 2000 65C14/15/17 |
| Connessione / Connected:  960899E3  960879-960864 | | | |

* I codici Emmerre con finale S sono kit di 2 dischi freno/Emmerre's codes with final S are sets of 2 brake discs

DISCHI FRENO
BRAKE DISCS
DISQUES DE FREIN
BREMSSCHEIBEN
ТОРМОЗНЫЕ ДИСКИ
DISCOS DE FRENOS

EMMERRE
spare parts for trucks and trailers

IVECO

| Applicazioni / Applications | Dettagli / Detail | Adattabile a / Adaptable to | Emmerre |
|---|---|-----------------------------|----------------------------------|
| Daily 2006 MY 35S10/S14/S11/S12 S13/S17/S18/S21/15 35C10/11/12/13/14/15/17/18/21 40C11/12/13/14/15/17/18/21 45C15/17/18/21 50C14/15/17/18/21 60C15/17/21 65C15/17/21 70C15/17/21 | - Assale anteriore/ Front Axle - Esterno/External Ø mm. 290 - Interno/Internal Ø mm. 64 - Altezza fascia/Height band mm. 46 - Spessore/Thickness mm. 28 - 9 Fori/Holes - Fascia autoventilata/Self-Ventilated Band - E11 90R - 02C01165/30137 E11 90R - 02C01195/26088 | 504121612 2996121 | 960512 960512S* |



| | | |
|--------------------------|----------|--------|
| Connessione / Connected: | 960513E3 | 960514 |
|--------------------------|----------|--------|

| | | | |
|---|--|----------------------|----------------------------------|
| Daily 2006 MY 35S14/12/13/17/18 35C12/13/14/17/18/11 50C17/40-45C17 60C17 65/70C17/C15/C24 | - Assale anteriore/ Front Axle - Esterno/External Ø mm. 300 - Interno/Internal Ø mm. 78 - Altezza fascia/Height band mm. 74,50 - Spessore/Thickness mm. 28 - 6 Fori/Holes - Fascia autoventilata/Self-Ventilated Band - E11 90R - 02C01165/30138 E11 90R - 02C01195/26089 | 504121605 2996131 | 960696 960696S* |
|---|--|----------------------|----------------------------------|



| | | |
|--------------------------|----------|--------|
| Connessione / Connected: | 960513E3 | 960514 |
|--------------------------|----------|--------|

| | | | |
|--|--|--------------------|----------------------------------|
| Daily 2006 MY 35S/C-10/14/11/12/13/17 S18/21 40C11/12/13/14/15/17/18 50C14/15/17/18 29L11/13/15 | - Assale posteriore/ Rear Axle - Esterno/External Ø mm. 294 - Interno/Internal Ø mm. 84 - Altezza fascia/Height band mm. 87,50 - Spessore/Thickness mm. 24 - 8 Fori/Holes - Con ABS/With ABS - Fascia autoventilata/Self-Ventilated Band - E11 90R - 02C01165/30136 E11 90R - 02C01195/34012 | 7186485 2996043 | 960515 960515S* |
|--|--|--------------------|----------------------------------|



| | | |
|--------------------------|----------|--------|
| Connessione / Connected: | 960516E3 | 960517 |
|--------------------------|----------|--------|

| | | | |
|---|--|--------------------|----------------------------------|
| Daily 2006 MY 35C/S10/14/12/13/15/17/18 40C11/12/13/14/15/17/18 50C14/15/17/18 | - Assale posteriore/ Rear Axle - Esterno/External Ø mm. 294 - Interno/Internal Ø mm. 84 - Altezza fascia/Height band mm. 84 - Spessore/Thickness mm. 24 - 8 Fori/Holes - Senza ABS/Without ABS - Fascia autoventilata/Self-Ventilated Band - Omologazione E11/Homologation E11: E11 90R - 02C01165/30136 | 7188210 2996033 | 960498 960498S* |
|---|--|--------------------|----------------------------------|



| | | |
|--------------------------|----------|--------|
| Connessione / Connected: | 960516E3 | 960517 |
|--------------------------|----------|--------|

* I codici Emmerre con finale S sono kit di 2 dischi freno/Emmerre's codes with final S are sets of 2 brake discs

I riferimenti indicati non sono originali ma perfettamente intercambiabili. I codici originali e le case costruttrici sono indicati a puro titolo informativo
The details described are not original but perfectly interchangeable. The original references and manufacturer names are given for information purposes only.

EMMERRE

spare parts for trucks and trailers

IVECO

DISCHI FRENO
BRAKE DISCS
DISQUES DE FREIN
BREMSSCHEIBEN
ТОРМОЗНЫЕ ДИСКИ
DISCOS DE FRENOS

| Emmerre | Adattabile a / Adaptable to | Dettagli / Detail | Applicazioni / Applications |
|--|-----------------------------|---|---|
| 960695 960695S* | 7186309 2996027 | <ul style="list-style-type: none">- Assale posteriore/Rear Axle- Esterno/External Ø mm. 296- Interno/Internal Ø mm. 76- Altezza fascia/Height band mm. 69,50- Spessore/Thickness mm. 16- 6 Fori/Holes- Con ABS/With ABS- Fascia piena/Full band <p>- Omologazione E11/Homologation E11: E11 90R - 02C01165/25157</p> | Daily 2006 MY 35C/S 11/12/18/10/14/13/15/17 40C10/11/13/14/15/17/21 29L11/13/15 50C15/17/21 65C15/17/21 70C15/17/21 |
| Connessione / Connected:  960516E3  960517 | | | |
| 960694 960694S* | 7188080 2996028 | <ul style="list-style-type: none">- Assale posteriore/Rear Axle- Esterno/External Ø mm. 296- Interno/Internal Ø mm. 76- Altezza fascia/Height band mm. 69,50- Spessore/Thickness mm. 16- 6 Fori/Holes- Senza ABS/Without ABS- Fascia piena/Full band <p>- Omologazione E11/Homologation E11: E11 90R - 02C01165/25157</p> | Daily 2006 MY 35S/C14/10/12/11/17/18 29L10/12/14 40C11/13/14/10 45C17/14 50C14/17 55S17 |
| Connessione / Connected:  960516E3  960517 | | | |
| 960697 960697S* | 504121723 2996122 | <ul style="list-style-type: none">- Assale anteriore/Front Axle- Esterno/External Ø mm. 300,50- Interno/Internal Ø mm. 83- Altezza fascia/Height band mm. 59- Spessore/Thickness mm. 30- 9 Fori/Holes- Fascia autoventilata/Self-Ventilated Band <p>- Omologazione E11/Homologation E11: E11 90R - 02C01165/30139</p> | Daily 2006 MY 60C17/15/18/14 70C14/17/15 65C14/17/18 |
| Connessione / Connected:  961015  960864 | | | |
| 960698 960698S* | 7186848 2996049 | <ul style="list-style-type: none">- Assale posteriore/Rear Axle- Esterno/External Ø mm. 306- Interno/Internal Ø mm. 178- Altezza fascia/Height band mm. 132- Spessore/Thickness mm. 28- 6 Fori/Holes- Fascia autoventilata/Self-Ventilated Band <p>- E11 90R - 02C01165/30216 E11 90R - 02C01047/37683</p> | Daily 2006 MY 60C15/17/18/14 65C14/15/17/18 70C14/17/15 35C/S17/15/21/14 40C17/15/21/14 45C17/15/21 50C17/15/21/14 |
| Connessione / Connected:  960895E3  960514 | | | |

* I codici Emmerre con finale S sono kit di 2 dischi freno/Emmerre's codes with final S are sets of 2 brake discs

DISCHI FRENO
BRAKE DISCS
DISQUES DE FREIN
BREMSSCHEIBEN
ТОРМОЗНЫЕ ДИСКИ
DISCOS DE FRENOS

EMMERRE
spare parts for trucks and trailers

IVECO

| Applicazioni / Applications | Dettagli / Detail | Adattabile a / Adaptable to | Emmerre |
|--|--|-------------------------------|--------------------|
| Turbozeta Zeta 65.12-79.14 | <ul style="list-style-type: none"> - Assale anteriore/ Front Axle - Esterno/External Ø mm. 315 - Interno/Internal Ø mm. 160 - Altezza fascia/Height band mm. 118,50 - Spessore/Thickness mm.26 - 6 Colonnelle/Bolts - Ø mm. 18 x 58 - Fascia autoventilata/Self-Ventilated Band | 7171274 1904532 7168368 | 960024 960024S* |
| Connessione / Connected:  960904-960903 | | | |
| Zeta 69.12/79.12/14 95.14/109.14 | <ul style="list-style-type: none"> - Assale anteriore/ Front Axle - Esterno/External Ø mm. 322 - Interno/Internal Ø mm. 220 - Altezza fascia/Height band mm. 129 - Spessore/Thickness mm. 30 - 8 Colonnelle/Bolts - Ø mm. 20 x 75 - Fascia autoventilata/Self-Ventilated Band - Omologazione E11/Homologation E11: E11 90R - 02C01047/33949 | 7171255 1907765 | 960032 960032S* |
| Connessione / Connected:  960939E3  960932 | | | |
| Eurocargo 60/65/75 Tector | <ul style="list-style-type: none"> - Assale anteriore e posteriore Front and Rear Axle - Esterno/External Ø mm. 304 - Interno/Internal Ø mm. 165 - Altezza fascia/Height band mm. 129 - Spessore/Thickness mm. 30 - 6 Fori/Holes - Fascia autoventilata/Self-Ventilated Band - E11 90R - 02C01165/37304 E11 90R - 02C01195/34523 | 7182681 1908577 1907725 | 960036 960036S* |
| Connessione / Connected:  960912E3-960029E3  960879-960877-960932-960888 | | | |
| Eurocargo 80E15-18 -21 100E15-18-21 Eurocargo Tector | <ul style="list-style-type: none"> - Assale anteriore e posteriore Front and Rear Axle - Esterno/External Ø mm. 322 - Interno/Internal Ø mm. 215 - Altezza fascia/Height band mm. 134 - Spessore/Thickness mm. 30 - 8 Fori/Holes - Fascia autoventilata/Self-Ventilated Band - Omologazione E11/Homologation E11: E11 90R - 02C01047/33949 | 7182682 1908578 1907726 | 960037 960037S* |
| Connessione / Connected:  960939E3-960902E3  960879-960877-960932-960888 | | | |

* I codici Emmerre con finale S sono kit di 2 dischi freno/Emmerre's codes with final S are sets of 2 brake discs

I riferimenti indicati non sono originali ma perfettamente intercambiabili. I codici originali e le case costruttrici sono indicati a puro titolo informativo
The details described are not original but perfectly interchangeable. The original references and manufacturer names are given for information purposes only.

EMMERRE

spare parts for trucks and trailers

IVECO

DISCHI FRENO
BRAKE DISCS
DISQUES DE FREIN
BREMSSCHEIBEN
ТОРМОЗНЫЕ ДИСКИ
DISCOS DE FRENOS

| Emmerre | Adattabile a / Adaptable to | Dettagli / Detail | Applicazioni / Applications |
|---|--|--|---|
| 960048 960048S*  | 7172881 1907568 7172880 7172930 | - Assale anteriore/ Front Axle - Esterno/External Ø mm. 370 - Interno/Internal Ø mm. 215 - Altezza fascia/Height band mm. 150 - Spessore/Thickness mm. 45 - 8 Colonnelle/Bolts - Ø mm. 20 x 75 - Fascia autoventilata/Self-Ventilated Band - Omologazione E11/Homologation E11: E11 90R - 02C01047/29169 | Eurocargo 130/150 280/320 |
| Connessione / Connected:  960938E3  960878-960880 | | | |
| 960049 960049S*  | 7172928 1907569 7172882 | - Assale anteriore/ Front Axle - Esterno/External Ø mm. 370 - Interno/Internal Ø mm. 215 - Altezza fascia/Height band mm. 181,5 - Spessore/Thickness mm. 45 - 8 Colonnelle/Bolts - Ø mm. 22 x 75 - Fascia autoventilata/Self-Ventilated Band - Omologazione E11/Homologation E11: E11 90R - 02C01047/29169 | Eurocargo 120/130/135 150/170/180 Tector 260/280 320 Tector |
| Connessione / Connected:  960938E3  960878-960880 | | | |
| 960409 960409S*  | 42102454 1908179 | - Assale anteriore/ Front Axle - Esterno/External Ø mm. 404,50 - Interno/Internal Ø mm. 170 - Altezza fascia/Height band mm. 60 - Spessore/Thickness mm. 30 - 20 Fori/Holes - Fascia autoventilata/Self-Ventilated Band | Eurocargo Tector Eurocargo Restyling Eurofire Eurofire Tector |
| Connessione / Connected:  960897  960852 | | | |
| 960068 960068S*  | 7187567 2996010 | - Assale posteriore/ Rear Axle - Esterno/External Ø mm. 304 - Interno/Internal Ø mm. 165 - Altezza fascia/Height band mm. 128,50 - Spessore/Thickness mm. 30 - 6 Fori/Holes - Con ABS/With ABS - Fascia autoventilata/Self-Ventilated Band - Omologazione E11/Homologation E11: E11 90R - 02C01047/37683 | Eurocargo 65 Tector 75 Tector |
| Connessione / Connected:  960912E3  960879 | | | |

* I codici Emmerre con finale S sono kit di 2 dischi freno/Emmerre's codes with final S are sets of 2 brake discs

DISCHI FRENO
BRAKE DISCS
DISQUES DE FREIN
BREMSSCHEIBEN
ТОРМОЗНЫЕ ДИСКИ
DISCOS DE FRENOS

EMMERRE
spare parts for trucks and trailers

IVECO

| Applicazioni / Applications | Dettagli / Detail | Adattabile a / Adaptable to | Emmerre |
|-----------------------------|---|---|--|
| Eurocargo Tector 130/150 | <ul style="list-style-type: none"> - Assale anteriore/ Front Axle - Esterno/External Ø mm. 377 - Interno/Internal Ø mm. 113 - Altezza fascia/Height band mm. 106,80 - Spessore/Thickness mm. 45 - 14 Fori/Holes - Fascia autoventilata/Self-Ventilated Band - E11 90R - 02C01047/21144 - E11 90R - 02C01165/30217 | <ul style="list-style-type: none"> 7189976 2996708 2995894 7187541 2995702 | <ul style="list-style-type: none"> 960402 960402S* |



Connessione / Connected:  960970E3  960878-960839



| | | | |
|----------------------|--|---|--|
| Eurocargo Tector 120 | <ul style="list-style-type: none"> - Assale anteriore e posteriore/ Front and Rear Axle - Esterno/External Ø mm. 330 - Interno/Internal Ø mm. 215 - Altezza fascia/Height band mm. 141 - Spessore/Thickness mm. 34 - 8 Fori/Holes - Con ABS/With ABS - Fascia autoventilata/Self-Ventilated Band - E11 90R - 02C01047/21145 - E11 90R - 02C01165/29061 | <ul style="list-style-type: none"> 7183632 1906466 7182199 42549008 | <ul style="list-style-type: none"> 960232 960232S* |
|----------------------|--|---|--|



Connessione / Connected:  960969E3-961041  960881-960805

| | | | |
|----------------------|--|--|--|
| Eurocargo Tector 130 | <ul style="list-style-type: none"> - Assale anteriore/ Front Axle - Esterno/External Ø mm. 377 - Interno/Internal Ø mm. 215 - Altezza fascia/Height band mm. 151,50 - Spessore/Thickness mm. 45 - 8 Colonnelle/Bolts - Ø mm. 20x75 - Fascia autoventilata/Self-Ventilated Band - E11 90R - 02C01047/21144 - E11 90R - 02C01165/30217 | <ul style="list-style-type: none"> 7189859 2996706 2992271 7183804 | <ul style="list-style-type: none"> 960104 960104S* |
|----------------------|--|--|--|



Connessione / Connected:  960970E3  960878-960839

| | | | |
|----------------------|---|--|--|
| Eurocargo Tector 150 | <ul style="list-style-type: none"> - Assale anteriore/ Front Axle - Esterno/External Ø mm. 377 - Interno/Internal Ø mm. 215 - Altezza fascia/Height band mm. 151 - Spessore/Thickness mm. 45 - 8 Colonnelle/Bolts - Ø mm. 22x75 - Fascia autoventilata/Self-Ventilated Band - E11 90R - 02C01047/21144 - E11 90R - 02C01165/30217 | <ul style="list-style-type: none"> 7189858 2992291 7187712 7183805 1908793 2996707 | <ul style="list-style-type: none"> 960020 960020S* |
|----------------------|---|--|--|



Connessione / Connected:  960970E3  960878-960880-960839

* I codici Emmerre con finale S sono kit di 2 dischi freno/Emmerre's codes with final S are sets of 2 brake discs

I riferimenti indicati non sono originali ma perfettamente intercambiabili. I codici originali e le case costruttrici sono indicati a puro titolo informativo
The details described are not original but perfectly interchangeable. The original references and manufacturer names are given for information purposes only.

EMMERRE

spare parts for trucks and trailers

IVECO

DISCHI FRENO
BRAKE DISCS
DISQUES DE FREIN
BREMSSCHEIBEN
ТОРМОЗНЫЕ ДИСКИ
DISCOS DE FRENOS



| Emmerre | Adattabile a / Adaptable to | Dettagli / Detail | Applicazioni / Applications |
|---|---|--|---|
| 960506 960506S*  | 7189864 2992635 7184077 7187713 2996709 | - Assale posteriore/Rear Axle - Esterno/External Ø mm. 377 - Interno/Internal Ø mm. 225 - Altezza fascia/Height band mm. 151 - Spessore/Thickness mm. 45 - 8 Colonnelle/Bolts - Ø mm. 20 x 86 - Con ABS/With ABS - Fascia autoventilata/Self-Ventilated Band - E11 90R - 02C01047/21144 E11 90R - 02C01165/30217 | Eurocargo Tector Tector Restyling 130 |
| Connessione / Connected:  960970E3  960839 | | | |
| 960507 960507S*  | 7189863 2996710 2992636 7184078 | - Assale posteriore/Rear Axle - Esterno/External Ø mm. 377 - Interno/Internal Ø mm. 225 - Altezza fascia/Height band mm. 151 - Spessore/Thickness mm. 45 - 8 Colonnelle/Bolts - Ø mm. 22 x 86 - Con ABS/With ABS - Fascia autoventilata/Self-Ventilated Band - E11 90R - 02C01047/21144 E11 90R - 02C01165/30217 | Eurocargo Tector Tector Restyling 150 |
| Connessione / Connected:  960970E3  960839 | | | |
| 960495 960495S*  | 7189265 2996419 | - Assale anteriore/Front Axle - Esterno/External Ø mm. 330 - Interno/Internal Ø mm. 185 - Altezza fascia/Height band mm. 129,5 - Spessore/Thickness mm. 32 - 6 Fori/Holes - Fascia autoventilata/Self-Ventilated Band - E11 90R - 02C01047/21145 E11 90R - 02C01165/29061 | Eurocargo Tector 65/75/80/90/100 |
| Connessione / Connected:  961033-961034  960864 | | | |
| 960494 960494S*  | 7189456 2996418 | - Assale posteriore/Rear Axle - Esterno/External Ø mm. 330 - Interno/Internal Ø mm. 185 - Altezza fascia/Height band mm. 129,50 - Spessore/Thickness mm. 32 - 6 Fori/Holes - Con ABS/With ABS - Fascia autoventilata/Self-Ventilated Band - E11 90R - 02C01047/21145 E11 90R - 02C01165/29061 | Eurocargo Tector 65/80/90/100 |
| Connessione / Connected:  961033-961034  960864 | | | |

* I codici Emmerre con finale S sono kit di 2 dischi freno/Emmerre's codes with final S are sets of 2 brake discs

DISCHI FRENO
BRAKE DISCS
DISQUES DE FREIN
BREMSSCHEIBEN
ТОРМОЗНЫЕ ДИСКИ
DISCOS DE FRENOS

EMMERRE
spare parts for trucks and trailers

IVECO

| Applicazioni / Applications | Dettagli / Detail | Adattabile a / Adaptable to | Emmerre |
|---|--|---|----------------------------------|
| Eurocargo Tector 100 | <ul style="list-style-type: none"> - Assale anteriore e posteriore/ Front and Rear Axle - Esterno/External Ø mm. 322 - Interno/Internal Ø mm. 215 - Altezza fascia/Height band mm. 134 - Spessore/Thickness mm. 30 - 8 Fori/Holes - Con ABS/With ABS - Fascia autoventilata/Self-Ventilated Band - E11 90R - 02C01195/26552 - E11 90R - 02C01165/30141 | 7187569 2996009 | 960111 960111S* |
| Connessione / Connected:  960912E3  960879 | | | |
| Eurocargo 170 Eurotech 190 260/400/180/240 Eurostar 190/240/260 | <ul style="list-style-type: none"> - Assale anteriore/Front Axle - Esterno/External Ø mm. 430 - Interno/Internal Ø mm. 160 - Altezza fascia/Height band mm. 102 - Spessore/Thickness mm. 50 - 12 Fori/Holes - 12 Colonnelle/Bolts - Ø mm. 16 x 80 - Fascia autoventilata/Self-Ventilated Band | 7173317 2991979 1908729 1907631 1908614 7180111 | 960033 960033S* |
| Connessione / Connected:  960937E3  960878-960880-960908-960839 | | | |
| Eurocargo 170 Eurotech 190 260/400/180/240 Eurostar 190/240/260 | <ul style="list-style-type: none"> - Assale anteriore/Front Axle - Esterno/External Ø mm. 430 - Interno/Internal Ø mm. 160 - Altezza fascia/Height band mm. 102 - Spessore/Thickness mm. 50 - 12 Fori/Holes - Senza Colonnelle/Without Bolts - Fascia autoventilata/Self-Ventilated Band | 7180111 7173317 2991979 1908729 1907631 1908614 | 960034 |
| Connessione / Connected:  960937E3  960878-960880-960908-960839 | | | |
| Eurocargo 180 Eurotrakker 190/260/340/380/410 Eurostar 190/260/440 Eurotech 190/260/400 Cursor Stralis 260/440 | <ul style="list-style-type: none"> - Assale anteriore e posteriore/ Front and Rear Axle - Esterno/External Ø mm. 436 - Interno/Internal Ø mm. 210 - Altezza fascia/Height band mm. 138,50 - Spessore/Thickness mm. 45 - 12 Fori/Holes - Fascia autoventilata/Self-Ventilated Band - E11 90R - 02C01047/19596 - E11 90R - 02C01165/24552 | 7182305 1906461 1906438 42557315 2996329 7184093 2992470 7179778 | 960053 960053S* |
| Connessione / Connected:  960944E1-960944E3-960794E3  960908-960839 | | | |



* I codici Emmerre con finale S sono kit di 2 dischi freno/Emmerre's codes with final S are sets of 2 brake discs





I riferimenti indicati non sono originali ma perfettamente intercambiabili. I codici originali e le case costruttrici sono indicati a puro titolo informativo
The details described are not original but perfectly interchangeable. The original references and manufacturer names are given for information purposes only.

EMMERRE

spare parts for trucks and trailers

IVECO

DISCHI FRENO
BRAKE DISCS
DISQUES DE FREIN
BREMSSCHEIBEN
ТОРМОЗНЫЕ ДИСКИ
DISCOS DE FRENOS

| Emmerre | Adattabile a / Adaptable to | Dettagli / Detail | Applicazioni / Applications |
|---|--|---|--|
| 960038 960038S* | 7184093 2992470 | <ul style="list-style-type: none">- Assale anteriore e posteriore/ Front and Rear Axle- Esterno/External Ø mm. 436- Interno/Internal Ø mm. 210- Altezza fascia/Height band mm. 138,50- Spessore/Thickness mm. 45- 12 Fori/Holes - Con/With Molibdeno- Fascia autoventilata/Self-Ventilated Band- E11 90R - 02C01047/19596- E11 90R - 02C01165/24552 | Stralis 260/440 Eurostar 190/260/440 Eurocargo 180 Eurotech 190/260/400 Eurotrakker 190/260/340 380/410 |
| Connessione / Connected:  960944E1-960944E3-960794E3  960908-960839 | | | |
| 960019 960019S* | 7184136 2992477 | <ul style="list-style-type: none">- Assale anteriore e posteriore/ Front and Rear Axle- Esterno/External Ø mm. 432- Interno/Internal Ø mm. 210- Altezza fascia/Height band mm. 138,50- Spessore/Thickness mm. 45- 12 Fori/Holes- Fascia autoventilata/Self-Ventilated Band- E11 90R - 02C01047/19596- E11 90R - 02C01165/24552 | Stralis 190/260/320/440 Eurocargo Tector 150/170/180 Eurotech 190/260/320/400 Eurotrakker 190/260/340 380/400/410/440/720 Trakker 190/260/340/380 400/410/440/720 |
| Connessione / Connected:  960944E1-960944E3-960794E3  960908-960839 | | | |
| 960404 960404S* | 7189475 2996327 | <ul style="list-style-type: none">- Assale anteriore e posteriore/ Front and Rear Axle- Esterno/External Ø mm. 432- Interno/Internal Ø mm. 210- Altezza fascia/Height band mm. 138,50- Spessore/Thickness mm. 45 - 12 Fori/Holes- Con ventilazione interna modificata /With internal ventilation modified- Fascia autoventilata/Self-Ventilated Band- E11 90R - 02C01047/19596- E11 90R - 02C01165/24552 | Stralis 190/260/440 |
| Connessione / Connected:  960944E1-960944E3-960794E3  960908-960839 | | | |
| 960405 960405S* | 7189476 7185503 2995812 2996328 | <ul style="list-style-type: none">- Assale anteriore e posteriore/ Front and Rear Axle- Esterno/External Ø mm. 432- Interno/Internal Ø mm. 210- Altezza fascia/Height band mm. 154- Spessore/Thickness mm. 45- 12 Fori/Holes - Con ABS/With ABS- Con ventilazione interna modificata /With internal ventilation modified- Fascia autoventilata/Self-Ventilated Band- E11 90R - 02C01047/19596- E11 90R - 02C01165/24552 | Stralis 190/260/440 |
| Connessione / Connected:  960944E1-960944E3-960794E3  960908-960839 | | | |

* I codici Emmerre con finale S sono kit di 2 dischi freno/Emmerre's codes with final S are sets of 2 brake discs

**DISCHI FRENO
BRAKE DISCS
DISQUES DE FREIN
BREMSSCHEIBEN
ТОРМОЗНЫЕ ДИСКИ
DISCOS DE FRENOS**

EMMERRE
spare parts for trucks and trailers

IVECO

| Applicazioni / Applications | Dettagli / Detail | Adattabile a / Adaptable to | Emmerre |
|---|---|--------------------------------|----------------------------------|
| Stralis 260/440 Eurocargo 180 Eurotech 180/190/240/260/400/440 Eurotrakker 190/260/380/410 | <ul style="list-style-type: none"> - Assale anteriore e posteriore/ Front and Rear Axle - Esterno/External Ø mm. 435 - Interno/Internal Ø mm. 210 - Altezza fascia/Height band mm. 138,50 - Spessore/Thickness mm. 45 - 12 Fori/Holes - Con ventilazione interna modificata /With internal ventilation modified - Fascia autoventilata/Self-Ventilated Band - E11 90R - 02C01047/19596 - E11 90R - 02C01165/24552 | 42557315 2996329 | 960406 960406S* |
| Connessione / Connected:  960944E1-960944E3-960794E3  960908-960839 | | | |
| Turbocity City Bus 480/580 | <ul style="list-style-type: none"> - Assale anteriore e posteriore/ Front and Rear Axle - Esterno/External Ø mm. 425 - Interno/Internal Ø mm. 285 - Altezza fascia/Height band mm. 170,50 - Spessore/Thickness mm. 45 - 10 Fori/Holes - Fascia autoventilata/Self-Ventilated Band | 42063700 1907764 | 960007 960007S* |
| Connessione / Connected:  960011E3  960508 | | | |
| Bus 370 | <ul style="list-style-type: none"> - Assale anteriore/Front Axle - Esterno/External Ø mm. 417 - Interno/Internal Ø mm. 157 - Altezza fascia/Height band mm. 80 - Spessore/Thickness mm. 30 - 10 Fori/Holes - Fascia autoventilata/Self-Ventilated Band - Omologazione E11/Homologation E11: E11 90R - 02C01165/33895 - Ref 960002S (Set di 4 pz./Set of 4 pcs.) | 93163055 8124117 1904534 | 960002 960002S* |
| Connessione / Connected:  960952E3  960508 | | | |
| Bus 380 Cityclass 491/591 Euroclass Eurorider | <ul style="list-style-type: none"> - Assale anteriore/Front Axle - Esterno/External Ø mm. 417 - Interno/Internal Ø mm. 159 - Altezza fascia/Height band mm. 67 - Spessore/Thickness mm. 28 - 10 Fori/Holes - Fascia autoventilata/Self-Ventilated Band - Omologazione E11/Homologation E11: E11 90R - 02C01165/33895 - Ref 960003S (Set di 4 pz./Set of 4 pcs.) | 93161407 | 960003 960003S* |
| Connessione / Connected:  960952E3  960508 | | | |

* I codici Emmerre con finale S sono kit di 2 dischi freno/Emmerre's codes with final S are sets of 2 brake discs







I riferimenti indicati non sono originali ma perfettamente intercambiabili. I codici originali e le case costruttrici sono indicati a puro titolo informativo
The details described are not original but perfectly interchangeable. The original references and manufacturer names are given for information purposes only.

EMMERRE

spare parts for trucks and trailers

IVECO





DISCHI FRENO
BRAKE DISCS
DISQUES DE FREIN
BREMSSCHEIBEN
ТОРМОЗНЫЕ ДИСКИ
DISCOS DE FRENOS

| Emmerre | Adattabile a / Adaptable to | Dettagli / Detail | Applicazioni / Applications |
|---|--|--|---------------------------------------|
| 960222 960222S* | 2994031 090390 | <ul style="list-style-type: none">- Assale anteriore/ Front Axle- Esterno/External Ø mm. 436- Interno/Internal Ø mm. 135- Altezza fascia/Height band mm. 131- Spessore/Thickness mm. 45- 12 Fori/Holes- Fascia autoventilata/Self-Ventilated Band- Omologazione E11/Homologation E11: E11 90R - 02C01047/26551 | Europolis Bus Menarini |
| Connessione / Connected:  960901E3  960676 | | | |
| 960224 960224S* | 42542659 2994084 031900 | <ul style="list-style-type: none">- Assale posteriore/Rear Axle- Esterno/External Ø mm. 436- Interno/Internal Ø mm. 210- Altezza fascia/Height band mm. 138,50- Spessore/Thickness mm. 45- 10 Fori/Holes- Fascia autoventilata/Self-Ventilated Band- E11 90R - 02C01047/19596 E11 90R - 02C01165/24552 | Europolis Bus Menarini BMB-M240 |
| Connessione / Connected:  960901E3  960676 | | | |
| 960490 | 503142233 5001860184 | <ul style="list-style-type: none">- Assale anteriore/ Front Axle- Esterno/External Ø mm. 434- Interno/Internal Ø mm. 210- Altezza fascia/Height band mm. 138,50- Spessore/Thickness mm. 45- 12 Fori/Holes - Con ABS/With ABS- Fascia autoventilata/Self-Ventilated Band- Omologazione E11/Homologation E11: E11 90R - 02C01165/24552 | Irisbus |
| Connessione / Connected:  960950E3 | | | |
| 960500 960500S* | 2996353 504134958 503621162 500055596 | <ul style="list-style-type: none">- Assale anteriore/ Front Axle- Esterno/External Ø mm. 434- Interno/Internal Ø mm. 131- Altezza fascia/Height band mm. 97- Spessore/Thickness mm. 45- 10 Fori/Holes- Fascia autoventilata/Self-Ventilated Band- Omologazione E11/Homologation E11: E11 90R - 02C01047/26550 | Bus City Elis Arway |
| Connessione / Connected:  960798E3  960807-960822 | | | |

DISCHI FRENO
BRAKE DISCS
DISQUES DE FREIN
BREMSSCHEIBEN
ТОРМОЗНЫЕ ДИСКИ
DISCOS DE FRENOS

EMMERRE
spare parts for trucks and trailers

IVECO

| Applicazioni / Applications | Dettagli / Detail | Adattabile a / Adaptable to | Emmerre |
|---|---|-----------------------------|---------------|
| Bus Menarini 231/4 | <ul style="list-style-type: none"> - Assale anteriore/ Front Axle - Esterno/External Ø mm. 430 - Interno/Internal Ø mm. 135 - Altezza fascia/Height band mm. 123 - Spessore/Thickness mm. 45 - 12 Fori/Holes - Fascia autoventilata/Self-Ventilated Band | D081944 | 960583 |
|  | | | |
| Connessione / Connected:  960944E1-960944E3 | | | |
| Iveco bus Euroraider Domino New Domino | <ul style="list-style-type: none"> - Assale anteriore e posteriore Front and Rear Axle - Esterno/External Ø mm. 430 - Interno/Internal Ø mm. 203 - Altezza fascia/Height band mm. 131 - Spessore/Thickness mm. 45 - 10 Fori/Holes - Fascia autoventilata/Self-Ventilated Band - Omologazione E11/Homologation E11: E11 90R - 02C01047/19596 | 42541277 | 960693 |
|  | | | |
| Connessione / Connected:  960956E1-960956E3  960914 | | | |

| Emmerre | Adattabile a / Adaptable to | Dettagli / Detail | Applicazioni / Applications |
|---------------|-------------------------------|---|--|
| 960397 | 120015000188 | <ul style="list-style-type: none"> - Esterno/External Ø mm. 430 - Interno/Internal Ø mm. 203 - Altezza fascia/Height band mm. 132,50 - Spessore/Thickness mm. 45 - 10 Fori/Holes - Con ABS/With ABS - Fascia autoventilata/Self-Ventilated Band - Omologazione E11/Homologation E11: E11 90R - 02C01047/19596 E11 90R - 02C01165/24552 | Karosa Bus 6455 FD 22/0 |
| | | | Connessione / Connected:  960944E1-960944E3 |
| 960399 | 120015000005V 12001500000S | <ul style="list-style-type: none"> - Esterno/External Ø mm. 430 - Interno/Internal Ø mm. 131 - Altezza fascia/Height band mm. 140 - Spessore/Thickness mm. 45 - 12 Fori/Holes - Fascia autoventilata/Self-Ventilated Band - Omologazione E11/Homologation E11: E11 90R - 02C01047/19596 E11 90R - 02C01165/24552 | FD 22/120 |
| | | | Connessione / Connected:  960944E1-960944E3 |

**DISCHI FRENO
BRAKE DISCS
DISQUES DE FREIN
BREMSSCHEIBEN
ТОРМОЗНЫЕ ДИСКИ
DISCOS DE FRENOS**

EMMERRE
spare parts for trucks and trailers

MAN

| Applicazioni / Applications | Dettagli / Detail | Adattabile a / Adaptable to | Emmerre |
|--|---|-----------------------------|---------------|
| L 2000 L 2100 | <ul style="list-style-type: none"> - Assale anteriore/ Front Axle - Esterno/External Ø mm. 324 - Interno/Internal Ø mm. 135 - Altezza fascia/Height band mm. 102 - Spessore/Thickness mm. 30 - 10 Fori/Holes - Fascia autoventilata/Self-Ventilated Band - E11 90R - 02C01047/26552 - E11 90R - 02C01165/27061 - E11 90R - 02C01165/30141 | 81508030010 81508030001 | 960320 |
| Connessione / Connected:  960969E3-961041-960955E3  960803-960553 | | | |
| L 2000 | <ul style="list-style-type: none"> - Assale anteriore/ Front Axle - Esterno/External Ø mm. 330 - Interno/Internal Ø mm. 135 - Altezza fascia/Height band mm. 104 - Spessore/Thickness mm. 34 - 10 Fori/Holes - Fascia autoventilata/Self-Ventilated Band - E11 90R - 02C01047/21145 - E11 90R - 02C01165/27061 - E11 90R - 02C01165/29061 | 81508030026 81508030024 | 960328 |
| Connessione / Connected:  960969E3-961041-960955E3  960803-960553 | | | |
| L 2000 | <ul style="list-style-type: none"> - Assale posteriore/ Rear Axle - Esterno/External Ø mm. 330 - Interno/Internal Ø mm. 157 - Altezza fascia/Height band mm. 124 - Spessore/Thickness mm. 34 - 12 Fori/Holes - Con ABS/With ABS - Fascia autoventilata/Self-Ventilated Band - E11 90R - 02C01047/21145 - E11 90R - 02C01165/27061 | 81508030061 81508030022 | 960343 |
| Connessione / Connected:  960969E3-961041-960955E3  960803-960553 | | | |
| L 2000 | <ul style="list-style-type: none"> - Assale posteriore/ Rear Axle - Esterno/External Ø mm. 330 - Interno/Internal Ø mm. 177 - Altezza fascia/Height band mm. 129,50 - Spessore/Thickness mm. 34 - 8 Fori/Holes - Fascia autoventilata/Self-Ventilated Band - E11 90R - 02C01047/21145 - E11 90R - 02C01165/27061 | 81508030039 | 960346 |
| Connessione / Connected:  960969E3-961041-960998E3-960955E3  960803-960553 | | | |

I riferimenti indicati non sono originali ma perfettamente intercambiabili. I codici originali e le case costruttrici sono indicati a puro titolo informativo
The details described are not original but perfectly interchangeable. The original references and manufacturer names are given for information purposes only.

| Emmerre | Adattabile a / Adaptable to | Dettagli / Detail | Applicazioni / Applications |
|--|-----------------------------|--|-----------------------------|
| 960419 | 81508030063 | <ul style="list-style-type: none"> - Assale posteriore/Rear Axle - Esterno/External Ø mm. 335 - Interno/Internal Ø mm. 154 - Altezza fascia/Height band mm. 118 - Spessore/Thickness mm. 34 - 10 Fori/Holes - Fascia autoventilata/Self-Ventilated Band - Omologazione E11/Homologation E11: E11 90R - 02C01047/21145 | TGL |
| | 81508030054 | | TGM |
| | 81508030062 | | |
| Connessione / Connected:  960998E3 | | | |
| 960344 | 81508030042 | <ul style="list-style-type: none"> - Assale anteriore/Front Axle - Esterno/External Ø mm. 335 - Interno/Internal Ø mm. 90 - Altezza fascia/Height band mm. 93 - Spessore/Thickness mm. 34 - 10 Fori/Holes - Fascia autoventilata/Self-Ventilated Band - E11 90R - 02C01047/21145 E11 90R - 02C01165/29061 | TGL |
| | 81508030053 | | TGM |
| | | | M2000 |
| | | | L2000 |
| Connessione / Connected:  960998E3 | | | |
| 960336 | 9704210012 | <ul style="list-style-type: none"> - Assale anteriore/Front Axle - Esterno/External Ø mm. 334,50 - Interno/Internal Ø mm. 91,5 - Altezza fascia/Height band mm. 102,50 - Spessore/Thickness mm. 34 - 10 Fori/Holes - Fascia autoventilata/Self-Ventilated Band - E11 90R - 02C01047/21145 E11 90R - 02C01165/29061 | TGL |
| | 9704210112 | | |
| | 9704210612 | | |
| Connessione / Connected:  960998E3 | | | |
| 960329 | 81508030057 | <ul style="list-style-type: none"> - Assale anteriore/Front Axle - Esterno/External Ø mm. 377 - Interno/Internal Ø mm. 162 - Altezza fascia/Height band mm. 128 - Spessore/Thickness mm.45 - 10 Fori/Holes - Fascia autoventilata/Self-Ventilated Band - E11 90R - 02C01047/21144 E11 90R - 02C01165/30217 | M 2000 |
| | 81508030027 | | |
| | 81508030020 | | |
| Connessione / Connected:  960948E3  960811 | | | |

DISCHI FRENO
BRAKE DISCS
DISQUES DE FREIN
BREMSSCHEIBEN
ТОРМОЗНЫЕ ДИСКИ
DISCOS DE FRENOS

EMMERRE
spare parts for trucks and trailers

MAN

| Applicazioni / Applications | Dettagli / Detail | Adattabile a / Adaptable to | Emmerre |
|--|---|--|---------------|
| F 90 F 2000 M 2000 TGA BUS | <ul style="list-style-type: none"> - Assale anteriore/ Front Axle - Esterno/External Ø mm. 438 - Interno/Internal Ø mm. 200 - Altezza fascia/Height band mm. 135 - Spessore/Thickness mm. 45 - 10 Fori/Holes - Fascia autoventilata/Self-Ventilated Band - Omologazione E11/Homologation E11: E11 90R - 02C01047/26551 | 81508030009 81508030014 | 960322 |
| Connessione / Connected:  960956E1-960956E3  960976 | | | |
| F 2000 M 2000 TGA TGX | <ul style="list-style-type: none"> - Assale anteriore e posteriore Front and Rear Axle - Esterno/External Ø mm. 432 - Interno/Internal Ø mm. 131 - Altezza fascia/Height band mm. 130 - Spessore/Thickness mm. 45 - 12 Fori/Holes - Fascia autoventilata/Self-Ventilated Band - Omologazione E11/Homologation E11: E11 90R - 02C01047/26551 | 81508030040 81508030023 81508030038 81508030031 | 960321 |
| Connessione / Connected:  960956E1-960956E3-960944E1-960944E3-960794E3  960807 | | | |
| F 2000 TGA TGX | <ul style="list-style-type: none"> - Assale anteriore e posteriore/ Front and Rear Axle - Esterno/External Ø mm. 432 - Interno/Internal Ø mm. 208 - Altezza fascia/Height band mm. 135 - Spessore/Thickness 45 - 10 Fori/Holes - Senza ABS/Without ABS - Fascia autoventilata/Self-Ventilated Band - E11 90R - 02C01047/19596 E11 90R - 02C01165/24552 | 81508030041 81508030021 | 960100 |
| Connessione / Connected:  960984E3  960807 | | | |
| TGA Bus | <ul style="list-style-type: none"> - Assale posteriore/Rear Axle - Esterno/External Ø mm. 432 - Interno/Internal Ø mm. 208 - Altezza fascia/Height band mm. 135 - Spessore/Thickness mm. 45 - 10 Fori/Holes - Con ABS/With ABS - Fascia autoventilata/Self-Ventilated Band - Omologazione E11/Homologation E11: E11 90R - 02C01047/26551 | 81508030048 81508030028 | 960393 |
| Connessione / Connected:  960793-960984E3  960807 | | | |

I riferimenti indicati non sono originali ma perfettamente intercambiabili. I codici originali e le case costruttrici sono indicati a puro titolo informativo
The details described are not original but perfectly interchangeable. The original references and manufacturer names are given for information purposes only.

| Emmerre | Adattabile a / <i>Adaptable to</i> | Dettagli / <i>Detail</i> | Applicazioni / <i>Applications</i> |
|---------------|---|--|------------------------------------|
| 960479 | 81508030044 | <ul style="list-style-type: none"> - Assale anteriore/ Front Axle - Esterno/<i>External</i> Ø mm. 377 - Interno/<i>Internal</i> Ø mm. 144 - Altezza fascia/<i>Height band</i> mm. 111 - Spessore/<i>Thickness</i> mm. 45 <ul style="list-style-type: none"> - 12 Fori/<i>Holes</i> - Fascia autoventilata/<i>Self-Ventilated Band</i> - Omologazione E11/Homologation E11: E11 90R - 02C01047/21144 | TGA TGM TGS TGX |
| | | Connessione / <i>Connected:</i>  960944E3 - 960944E1 | |
| 960480 | 81508030064 81508030058 81508030056 | <ul style="list-style-type: none"> - Assale anteriore/ Front Axle - Esterno/<i>External</i> Ø mm. 432 - Interno/<i>Internal</i> Ø mm. 230 - Altezza fascia/<i>Height band</i> mm. 119 - Spessore/<i>Thickness</i> mm. 45 <ul style="list-style-type: none"> - 16 Fori/<i>Holes</i> - Fascia autoventilata/<i>Self-Ventilated Band</i> - Omologazione E11/Homologation E11: E11 90R - 02C01047/19596 | TGA TGS TGX |
| | | Connessione / <i>Connected:</i>  960944E3 - 960944E1-960794E3 | |

DISCHI FRENO
BRAKE DISCS
DISQUES DE FREIN
BREMSSCHEIBEN
ТОРМОЗНЫЕ ДИСКИ
DISCOS DE FRENOS

EMMERRE
spare parts for trucks and trailers

MERCEDES

| Applicazioni / Applications | Dettagli / Detail | Adattabile a / Adaptable to | Emmerre |
|---|---|-----------------------------|---------------|
| Vito | <ul style="list-style-type: none"> - Assale anteriore/ Front Axle - Esterno/External Ø mm. 276 - Interno/Internal Ø mm. 67 - Altezza fascia/Height band mm. 60 - Spessore/Thickness mm. 22 - 5 Fori/Holes - Fascia autoventilata/Self-Ventilated Band | 6384210112 | 960333 |
| Connessione / Connected:  960921  960915 | | | |
| Vito | <ul style="list-style-type: none"> - Assale posteriore/Rear Axle - Esterno/External Ø mm. 280 - Interno/Internal Ø mm. 67 - Altezza fascia/Height band mm. 65 - Spessore/Thickness mm. 10 - 5 Fori/Holes - Fascia piena/Full band | 6384230112 | 960334 |
| Connessione / Connected:  960926-960777  960915 | | | |
| Vito Viano | <ul style="list-style-type: none"> - Assale posteriore/Rear Axle - Esterno/External Ø mm. 296 - Interno/Internal Ø mm. 67 - Altezza fascia/Height band mm. 57,50 - Spessore/Thickness mm. 10 - 5 Fori/Holes - Fascia piena/Full band | 6394230112 | 960450 |
| Connessione / Connected:  960451  960825 | | | |
| Vito Viano | <ul style="list-style-type: none"> - Assale anteriore/ Front Axle - Esterno/External Ø mm. 300 - Interno/Internal Ø mm. 67 - Altezza fascia/Height band mm. 58,50 - Spessore/Thickness mm. 28 - 5 Fori/Holes - Fascia autoventilata/Self-Ventilated Band - Omologazione E11/Homologation E11: E11 90R - 02C01165/30138 | 6394210012 6394210312 | 960421 |
| Connessione / Connected:  960890-960792  960824 | | | |

| Emmerre | Adattabile a / Adaptable to | Dettagli / Detail | Applicazioni / Applications |
|---|--|---|-----------------------------|
| 960686 | 6694210512 6694210712 | <ul style="list-style-type: none"> - Assale anteriore/ Front Axle - Esterno/External Ø mm. 324 - Interno/Internal Ø mm. 184 - Altezza fascia/Height band mm. 112 - Spessore/Thickness mm. 30 <li style="padding-left: 20px;">- 6 Fori/Holes - Fascia autoventilata/Self-Ventilated Band | T2/LN1 Vario |
| Connessione / Connected:  960946E3  960916 | | | |
| 960324 | 9024210612 9024210412 9024210712 9024210312 9024210912 | <ul style="list-style-type: none"> - Assale anteriore/ Front Axle - Esterno/External Ø mm. 276 - Interno/Internal Ø mm. 85 - Altezza fascia/Height band mm. 77 - Spessore/Thickness mm. 22 <li style="padding-left: 20px;">- 5 +2 Fori/Holes - Fascia autoventilata/Self-Ventilated Band - E11 90R - 02C01165/30122 - E11 90R - 02C01195/26087 | Sprinter |
| Connessione / Connected:  960921-960920E3  960915 | | | |
| 960323 | 9044230312 9044230212 2D0615601B | <ul style="list-style-type: none"> - Assale posteriore/Rear Axle - Esterno/External Ø mm. 285 - Interno/Internal Ø mm. 120 - Altezza fascia/Height band mm. 93 - Spessore/Thickness mm. 22 <li style="padding-left: 20px;">- 6 Fori/Holes - Fascia autoventilata/Self-Ventilated Band - Omologazione E11/Homologation E11: - E11 90R - 02C01195/29057 | Sprinter Volkswagen |
| Connessione / Connected:  960920E3  960915 | | | |
| 960390 | 9024230312 9024230112 2D0615601A 9024230512 9024230412 2D0615601D | <ul style="list-style-type: none"> - Assale posteriore/Rear Axle - Esterno/External Ø mm. 272 - Interno/Internal Ø mm. 85 - Altezza fascia/Height band mm. 96,50 - Spessore/Thickness mm. 16 <li style="padding-left: 20px;">- 5 Fori/Holes Ø mm. 17 - Fascia piena/Full band | Sprinter Volkswagen |
| Connessione / Connected:  960922  960915 | | | |

DISCHI FRENO
BRAKE DISCS
DISQUES DE FREIN
BREMSSCHEIBEN
ТОРМОЗНЫЕ ДИСКИ
DISCOS DE FRENOS

EMMERRE
spare parts for trucks and trailers

MERCEDES

| Applicazioni / Applications | Dettagli / Detail | Adattabile a / Adaptable to | Emmerre |
|--|--|--|---------------|
| Sprinter Volkswagen LT | <ul style="list-style-type: none"> - Assale posteriore/Rear Axle - Esterno/External Ø mm. 258 - Interno/Internal Ø mm. 85 - Altezza fascia/Height band mm. 96,50 - Spessore/Thickness mm. 12 - 5 Fori/Holes - Fascia piena/Full band - Omologazione E11/Homologation E11: E11 90R - 02C01195/25833 | 9014230812 2D0615601C 9014231012 | 960391 |
| Connessione / Connected:  960922  960915 | | | |
| Sprinter Volkswagen | <ul style="list-style-type: none"> - Assale anteriore/Front Axle - Esterno/External Ø mm. 300 - Interno/Internal Ø mm. 85 - Altezza fascia/Height band mm. 68,50 - Spessore/Thickness mm. 28 - 6 Fori/Holes - Fascia autoventilata/Self-Ventilated Band - E11 90R - 02C01165/30138 E11 90R - 02C01195/26089 | 9064210012 2E0615301 | 960564 |
| Connessione / Connected:  960890-960427  960824 | | | |
| Sprinter Volkswagen | <ul style="list-style-type: none"> - Assale posteriore/Rear Axle - Esterno/External Ø mm. 298 - Interno/Internal Ø mm. 85 - Altezza fascia/Height band mm. 71 - Spessore/Thickness mm. 16 - 6 Fori/Holes - Fascia piena/Full band | 9064230012 2E0615601A | 960565 |
| Connessione / Connected:  960890-960776  960825-960435 | | | |
| Sprinter Volkswagen | <ul style="list-style-type: none"> - Assale posteriore/Rear Axle - Esterno/External Ø mm. 303 - Interno/Internal Ø mm. 120 - Altezza fascia/Height band mm. 93 - Spessore/Thickness mm. 28 - 6 Fori/Holes - Fascia autoventilata/Self-Ventilated Band - Omologazione E11/Homologation E11: E11 90R - 02C01047/37683 | 9064230112 2E0615601 | 960422 |
| Connessione / Connected:  960896  960825 | | | |

I riferimenti indicati non sono originali ma perfettamente intercambiabili. I codici originali e le case costruttrici sono indicati a puro titolo informativo
The details described are not original but perfectly interchangeable. The original references and manufacturer names are given for information purposes only.

EMMERRE

spare parts for trucks and trailers

MERCEDES

DISCHI FRENO
BRAKE DISCS
DISQUES DE FREIN
BREMSSCHEIBEN
ТОРМОЗНЫЕ ДИСКИ
DISCOS DE FRENOS

| Emmerre | Adattabile a / Adaptable to | Dettagli / Detail | Applicazioni / Applications |
|---|--|--|--|
| 960124  | 9054210012 90541011207 | <ul style="list-style-type: none">- Assale anteriore/ Front Axle- Esterno/External Ø mm. 290- Interno/Internal Ø mm. 70- Altezza fascia/Height band mm. 70- Spessore/Thickness mm. 26- 8 Fori/Holes- Fascia autoventilata/Self-Ventilated Band- Omologazione E11/Homologation E11: E11 90R - 02C01195/26088 | Sprinter Vario |
| Connessione / Connected:  960973E3-960775  960916 | | | |
| 960125  | 9054200072 | <ul style="list-style-type: none">- Assale posteriore/ Rear Axle- Esterno/External Ø mm. 304- Interno/Internal Ø mm. 120- Altezza fascia/Height band mm. 115- Spessore/Thickness mm. 30- 6 Fori/Holes- Con ABS/With ABS- Fascia autoventilata/Self-Ventilated Band- Omologazione E11/Homologation E11: E11 90R - 02C01047/37683 | Sprinter Vario |
| Connessione / Connected:  960946E3  960916 | | | |
| 960335  | 6014200372 6014200172 6014210312 6014210512 | <ul style="list-style-type: none">- Assale anteriore/ Front Axle- Esterno/External Ø mm. 280- Interno/Internal Ø mm. 88- Altezza fascia/Height band mm. 79- Spessore/Thickness mm. 22- 5 Fori/Holes- Fascia piena/Full band- Omologazione E11/Homologation E11: E11 90R - 02C01165/25156 | T2/LN1 508 T2/LN1 510 T2/L 608D T2/L 613D |
| Connessione / Connected:  960967E3  960842 | | | |
| 960319  | 6694210612 6694210112 6684210112 6684210612 | <ul style="list-style-type: none">- Assale anteriore/ Front Axle- Esterno/External Ø mm. 304- Interno/Internal Ø mm. 118- Altezza fascia/Height band mm. 91- Spessore/Thickness mm. 30- 6 Fori/Holes- Fascia autoventilata/Self-Ventilated Band- E11 90R - 02C01165/37304 E11 90R - 02C01195/34523 | T2/LN1 609D T2/LN1 709D T2/LN1 711D |
| Connessione / Connected:  960946E3  960916 | | | |

DISCHI FRENO
BRAKE DISCS
DISQUES DE FREIN
BREMSSCHEIBEN
ТОРМОЗНЫЕ ДИСКИ
DISCOS DE FRENOS

EMMERRE
spare parts for trucks and trailers

Dischi Freno
Brake Discs

MERCEDES

| Applicazioni / Applications | Dettagli / Detail | Adattabile a / Adaptable to | Emmerre |
|--|---|--|---------------|
| 809D 811D T2LN1 Vario | <ul style="list-style-type: none"> - Assale anteriore/ Front Axle - Esterno/External Ø mm. 324 - Interno/Internal Ø mm. 118 - Altezza fascia/Height band mm. 91 - Spessore/Thickness mm. 30 - 6 Fori/Holes - Fascia autoventilata/Self-Ventilated Band - Omologazione E11/Homologation E11: E11 90R - 02C01165/27061 E11 90R - 02C01047/26552 | 6704210312 6704210112 6684210212 | 960318 |
| Connessione / Connected:  960946E3  960916 | | | |
| Vario 512D 612D 812D | <ul style="list-style-type: none"> - Assale posteriore/Rear Axle - Esterno/External Ø mm. 304 - Interno/Internal Ø mm. 157 - Altezza fascia/Height band mm. 120,50 - Spessore/Thickness mm. 30 - 6 Fori/Holes - Fascia autoventilata/Self-Ventilated Band - E11 90R - 02C01165/30139 E11 90R - 02C01047/26552 | 6684230012 | 960446 |
| Connessione / Connected:  960946E3  960916 | | | |
| Vario 512D 615D 812D 814D T2LN1 | <ul style="list-style-type: none"> - Assale posteriore/Rear Axle - Esterno/External Ø mm. 304 - Interno/Internal Ø mm. 120 - Altezza fascia/Height band mm. 121 - Spessore/Thickness mm. 30 - 6 Fori/Holes - Fascia autoventilata/Self-Ventilated Band - Omologazione E11/Homologation E11: E11 90R - 02C01047/37683 | 6684230412 6684230212 | 960447 |
| Connessione / Connected:  960946E3  960916 | | | |
| Vario 512D 812D 814D 0810 0814 | <ul style="list-style-type: none"> - Assale posteriore/Rear Axle - Esterno/External Ø mm. 324 - Interno/Internal Ø mm. 157 - Altezza fascia/Height band mm. 120,50 - Spessore/Thickness mm. 30 - 6 Fori/Holes - Con ABS/With ABS - Fascia autoventilata/Self-Ventilated Band - E11 90R - 02C01165/27061 E11 90R - 02C01047/26552 | 6684230512 | 960073 |
| Connessione / Connected:  960946E3  960916 | | | |

I riferimenti indicati non sono originali ma perfettamente intercambiabili. I codici originali e le case costruttrici sono indicati a puro titolo informativo
The details described are not original but perfectly interchangeable. The original references and manufacturer names are given for information purposes only.

| Emmerre | Adattabile a / Adaptable to | Dettagli / Detail | Applicazioni / Applications |
|--|---|--|--|
| <p>960074</p>  | 6684230112 | <ul style="list-style-type: none"> - Assale posteriore/Rear Axle - Esterno/External Ø mm. 324 - Interno/Internal Ø mm. 157 - Altezza fascia/Height band mm. 120,50 - Spessore/Thickness mm. 30 - 6 Fori/Holes - Fascia autoventilata/Self-Ventilated Band - E11 90R - 02C01047/26552 - E11 90R - 02C01165/27061 | <p>Vario</p> <p>613D</p> <p>614D</p> <p>813D</p> <p>814D</p> |
| Connessione / Connected:  960946E3  960916 | | | |
| <p>960336</p>  | <p>9704210612</p> <p>9704210112</p> <p>9704210212</p> <p>9704210012</p> | <ul style="list-style-type: none"> - Assale anteriore/Front Axle - Esterno/External Ø mm. 334,50 - Interno/Internal Ø mm. 91,60 - Altezza fascia/Height band mm. 102,50 - Spessore/Thickness mm. 34 - 10 Fori/Holes - Fascia autoventilata/Self-Ventilated Band - E11 90R - 02C01047/21145 - E11 90R - 02C01165/29061 | Atego I |
| Connessione / Connected:  960998E3 | | | |
| <p>960337</p>  | <p>9704230612</p> <p>9704230412</p> | <ul style="list-style-type: none"> - Assale posteriore/Rear Axle - Esterno/External Ø mm. 335 - Interno/Internal Ø mm. 145 - Altezza fascia/Height band mm. 111 - Spessore/Thickness mm. 34 - 8 Fori/Holes - Fascia autoventilata/Self-Ventilated Band - E11 90R - 02C01047/21145 - E11 90R - 02C01165/29061 | Atego I |
| Connessione / Connected:  960998E3 | | | |
| <p>960338</p>  | <p>9704230712</p> <p>9704230512</p> | <ul style="list-style-type: none"> - Assale posteriore/Rear Axle - Esterno/External Ø mm. 335 - Interno/Internal Ø mm. 152 - Altezza fascia/Height band mm. 111 - Spessore/Thickness mm. 34 - 8 Fori/Holes - Fascia autoventilata/Self-Ventilated Band - Omologazione E11/Homologation E11: - E11 90R - 02C01047/21145 | <p>Atego I</p> <p>Atego II</p> |
| Connessione / Connected:  960998E3 | | | |



DISCHI FRENO
BRAKE DISCS
DISQUES DE FREIN
BREMSSCHEIBEN
ТОРМОЗНЫЕ ДИСКИ
DISCOS DE FRENOS

EMMERRE
spare parts for trucks and trailers

MERCEDES

| Applicazioni / Applications | Dettagli / Detail | Adattabile a / Adaptable to | Emmerre |
|--|--|--|---------------|
| Atego I Atego II | <ul style="list-style-type: none"> - Assale posteriore/Rear Axle - Esterno/External Ø mm. 330 - Interno/Internal Ø mm. 177 - Altezza fascia/Height band mm. 129,50 - Spessore/Thickness mm. 34 - 8 Fori/Holes - Fascia autoventilata/Self-Ventilated Band - E11 90R - 02C01047/21145 - E11 90R - 02C01165/27061 | 9704230212 | 960346 |
| Connessione / Connected:  960998E3 | | | |
| Atego I Atego II | <ul style="list-style-type: none"> - Assale anteriore/Front Axle - Esterno/External Ø mm. 377 - Interno/Internal Ø mm. 105,60 - Altezza fascia/Height band mm. 134 - Spessore/Thickness mm. 45 - 14 Fori/Holes - Fascia autoventilata/Self-Ventilated Band - E11 90R - 02C01047/21144 - E11 90R - 02C01165/30217 | 9754210112 9754210212 9754210012 6754210112 9754210512 | 960339 |
| Connessione / Connected:  960948E3 | | | |
| Atego I | <ul style="list-style-type: none"> - Assale posteriore/Rear Axle - Esterno/External Ø mm. 377 - Interno/Internal Ø mm. 176 - Altezza fascia/Height band mm. 138,40 - Spessore/Thickness mm. 45 - 8 Fori/Holes - Fascia autoventilata/Self-Ventilated Band - E11 90R - 02C01047/21144 - E11 90R - 02C01165/30217 | 9754230612 9754230312 6754230312 | 960341 |
| Connessione / Connected:  960948E3 | | | |
| Actros 22,5" Atego Axor II Citaro Travego | <ul style="list-style-type: none"> - Assale anteriore e posteriore Front and Rear Axle - Esterno/External Ø mm. 430 - Interno/Internal Ø mm. 211 - Altezza fascia/Height band mm. 132,50 - Spessore/Thickness mm. 45 - 10 Fori/Holes - Fascia autoventilata/Self-Ventilated Band - E11 90R - 02C01047/19596 - E11 90R - 02C01165/24552 | 9424212112 9424230012 9424211212 9424212612 9424211312 | 960316 |
| Connessione / Connected:  960944E1-960944E3-960794E3-960796E3-960797E3-960891 | | | |

I riferimenti indicati non sono originali ma perfettamente intercambiabili. I codici originali e le case costruttrici sono indicati a puro titolo informativo
The details described are not original but perfectly interchangeable. The original references and manufacturer names are given for information purposes only.

| Emmerre | Adattabile a / Adaptable to | Dettagli / Detail | Applicazioni / Applications |
|---|--|---|--|
| 960317 | 9434210312 | <ul style="list-style-type: none"> - Assale anteriore e posteriore <i>Front and Rear Axle</i> - Esterno/External Ø mm. 430 - Interno/Internal Ø mm. 131 - Altezza fascia/Height band mm. 143,50 - Spessore/Thickness mm. 45 - 10 Fori/Holes - Fascia autoventilata/Self-Ventilated Band - E11 90R - 02C01047/19596 - E11 90R - 02C01165/24552 | <ul style="list-style-type: none"> Actros MP2 MP3 Atego Atego II Axor Econic Travego |
| Connessione / Connected:  960944E1-960944E3-960794E3 -960796E3-960797E3 | | | |
| 960693 | 82135830 0004200272 0004210312 0004200172 0004200272 54241277 | <ul style="list-style-type: none"> - Assale anteriore e posteriore <i>Front and Rear Axle</i> - Esterno/External Ø mm. 430 - Interno/Internal Ø mm. 203 - Altezza fascia/Height band mm. 131 - Spessore/Thickness mm. 45 - 10 Fori/Holes - Fascia autoventilata/Self-Ventilated Band - Omologazione E11/Homologation E11: - E11 90R - 02C01047/19596 | <ul style="list-style-type: none"> Evobus Neoplan Menarini Europolis Avancity |
| Connessione / Connected:  960956E1-960956E3  960914 | | | |
| 960315 | 3564210312 3564211012 3564211212 | <ul style="list-style-type: none"> - Assale anteriore e posteriore <i>Front and Rear Axle</i> - Esterno/External Ø mm. 438 - Interno/Internal Ø mm. 195 - Altezza fascia/Height band mm. 135 - Spessore/Thickness mm. 45 - 10 Fori/Holes - Fascia autoventilata/Self-Ventilated Band - E11 90R - 02C01047/19596 - E11 90R - 02C01165/24552 | <ul style="list-style-type: none"> 0303 0305 0404 Neoplan 1991 Tourismo 0340 - 0350 |
| Connessione / Connected:  960956E1-960956E3  960914 | | | |
| 960449 | 9604210312 | <ul style="list-style-type: none"> - Assale anteriore e posteriore <i>Front and Rear Axle</i> - Esterno/External Ø mm. 430 - Interno/Internal Ø mm. 168 - Altezza fascia/Height band mm. 131 - Spessore/Thickness mm. 45 - 10 Fori/Holes - Fascia autoventilata/Self-Ventilated Band - Omologazione E11/Homologation E11: - E11 90R - 02C01047/19596 | <ul style="list-style-type: none"> Actros MP2 Actros MP4 |

DISCHI FRENO
BRAKE DISCS
DISQUES DE FREIN
BREMSSCHEIBEN
ТОРМОЗНЫЕ ДИСКИ
DISCOS DE FRENOS

EMMERRE
spare parts for trucks and trailers

mitsubishi

| Applicazioni / Applications | Dettagli / Detail | Adattabile a / Adaptable to | Emmerre |
|-----------------------------|---|-----------------------------|---------------|
| Canter 35 Q. | <ul style="list-style-type: none"> - Assale anteriore/ Front Axle - Esterno/External Ø mm. 290 - Interno/Internal Ø mm. 104 - Altezza fascia/Height band mm. 73 - Spessore/Thickness mm. 20 - 6 Fori/Holes - Fascia autoventilata/Self-Ventilated Band | QMB295971 | 960539 |
| Canter 63 Q. | <ul style="list-style-type: none"> - Assale anteriore e posteriore Front and Rear Axle - Esterno/External Ø mm. 293 - Interno/Internal Ø mm. 114 - Altezza fascia/Height band mm. 54 - Spessore/Thickness mm. 40 - 6 Fori/Holes - Fascia autoventilata/Self-Ventilated Band | ADC44383 MC894846 | 960540 |
| Canter 75 Q. | <ul style="list-style-type: none"> - Assale anteriore/ Front Axle - Esterno/External Ø mm. 309 - Interno/Internal Ø mm. 114 - Altezza fascia/Height band mm. 54 - Spessore/Thickness mm. 40 - 6 Fori/Holes - Fascia autoventilata/Self-Ventilated Band | QMK326334 | 960541 |
| Canter 3.0/3.0 TDI | <ul style="list-style-type: none"> - Assale anteriore/ Front Axle - Esterno/External Ø mm. 293 - Interno/Internal Ø mm. 110 - Altezza fascia/Height band mm. 54 - Spessore/Thickness mm. 40 - 5 Fori/Holes - Fascia autoventilata/Self-Ventilated Band | MC894847 | 960543 |

| Emmerre | Adattabile a / <i>Adaptable to</i> | Dettagli / <i>Detail</i> | Applicazioni / <i>Applications</i> |
|--|------------------------------------|--|--|
| <p>960546</p>  | <p>MK374048</p> | <ul style="list-style-type: none"> - Assale posteriore/Rear Axle - Esterno/<i>External</i> Ø mm. 310 - Interno/<i>Internal</i> Ø mm. 139 - Altezza fascia/<i>Height band</i> mm. 70,5 - Spessore/<i>Thickness</i> mm. 40 <li style="padding-left: 20px;">- 12 Fori/<i>Holes</i> - Fascia autoventilata/<i>Self-Ventilated Band</i> | <p>Canter 4.9 DiTD Canter 3.9 TDI</p> |
| | | | |
| | | | |
| | | | |

DISCHI FRENO
BRAKE DISCS
DISQUES DE FREIN
BREMSSCHEIBEN
ТОРМОЗНЫЕ ДИСКИ
DISCOS DE FRENOS

EMMERRE
spare parts for trucks and trailers

NISSAN

| Applicazioni / Applications | Dettagli / Detail | Adattabile a / Adaptable to | Emmerre |
|--|---|-----------------------------|---------------|
| Cabstar | <ul style="list-style-type: none"> - Assale anteriore/ Front Axle - Esterno/External Ø mm. 276 - Interno/Internal Ø mm. 120 - Altezza fascia/Height band mm. 45 - Spessore/Thickness mm. 28 - 6 Fori/Holes - Fascia autoventilata/Self-Ventilated Band | 40206-LC60A | 960483 |
|  | | | |
| Connessione / Connected:  960787 | | | |
| Cabstar Atleon 100 Atleon 120 Eco T100 Trade | <ul style="list-style-type: none"> - Assale anteriore/ Front Axle - Esterno/External Ø mm. 263 - Interno/Internal Ø mm. 96 - Altezza fascia/Height band mm. 53 - Spessore/Thickness mm. 24 - 6 Fori/Holes - Fascia autoventilata/Self-Ventilated Band | 40206F3901 | 960056 |
| Connessione / Connected:  960872E3 | | | |
| Cabstar E75/90 Trade 100/75 | <ul style="list-style-type: none"> - Assale anteriore e posteriore Front and Rear Axle - Esterno/External Ø mm. 263 - Interno/Internal Ø mm. 96 - Altezza fascia/Height band mm. 53 - Spessore/Thickness mm. 24 - 5 Fori/Holes - Fascia autoventilata/Self-Ventilated Band | 40206F3902 | 960055 |
| Connessione / Connected:  960872E3 | | | |
| Cabstar 28/35/45 Cabstar E 110/120 | <ul style="list-style-type: none"> - Assale anteriore/ Front Axle - Esterno/External Ø mm. 276 - Interno/Internal Ø mm. 94 - Altezza fascia/Height band mm. 45 - Spessore/Thickness mm. 28 - 5 Fori/Holes - Fascia autoventilata/Self-Ventilated Band - Omologazione E11/Homologation E11: E11 90R - 02C01165/30134 | 40206MB600 | 960462 |
| Connessione / Connected:  960461-960787 | | | |

I riferimenti indicati non sono originali ma perfettamente intercambiabili. I codici originali e le case costruttrici sono indicati a puro titolo informativo
The details described are not original but perfectly interchangeable. The original references and manufacturer names are given for information purposes only.

EMMERRE

spare parts for trucks and trailers

NISSAN

DISCHI FRENO
BRAKE DISCS
DISQUES DE FREIN
BREMSSCHEIBEN
ТОРМОЗНЫЕ ДИСКИ
DISCOS DE FRENOS

| Emmerre | Adattabile a / Adaptable to | Dettagli / Detail | Applicazioni / Applications |
|---|-----------------------------|---|-----------------------------|
| 960458  | 43206MB600 | <ul style="list-style-type: none">- Assale posteriore/Rear Axle- Esterno/External Ø mm. 280- Interno/Internal Ø mm. 108- Altezza fascia/Height band mm. 62- Spessore/Thickness mm. 16<ul style="list-style-type: none">- 6 Fori/Holes- Senza ABS/Without ABS- Fascia piena/Full band- Omologazione E11/Homologation E11: E11 90R - 02C01165/24893 | Cabstar 28/35/45 |
| Connessione / Connected:  960459 | | | |
| 960460  | 43206MB60A | <ul style="list-style-type: none">- Assale posteriore/Rear Axle- Esterno/External Ø mm. 280- Interno/Internal Ø mm. 108- Altezza fascia/Height band mm. 67- Spessore/Thickness mm. 16<ul style="list-style-type: none">- 6 Fori/Holes- Con ABS/With ABS- Fascia piena/Full band | Cabstar |
| Connessione / Connected:  960459 | | | |
| 960059  | 402069X200 402069X500 | <ul style="list-style-type: none">- Assale anteriore/Front Axle- Esterno/External Ø mm. 276- Interno/Internal Ø mm. 96- Altezza fascia/Height band mm. 49,50- Spessore/Thickness mm. 24<ul style="list-style-type: none">- 5 Fori/Holes- Fascia autoventilata/Self-Ventilated Band | Cabstar E 75/90 |
| Connessione / Connected:  960874E3 | | | |
| 960192  | 4020600Q0G | <ul style="list-style-type: none">- Assale anteriore/Front Axle- Esterno/External Ø mm. 302- Interno/Internal Ø mm. 90- Altezza fascia/Height band mm. 70- Spessore/Thickness mm. 28<ul style="list-style-type: none">- 5 Fori/Holes- Fascia autoventilata/Self-Ventilated Band- Omologazione E11/Homologation E11: E11 90R - 02C01195/34523 | BUS NV400 |

DISCHI FRENO
BRAKE DISCS
DISQUES DE FREIN
BREMSSCHEIBEN
ТОРМОЗНЫЕ ДИСКИ
DISCOS DE FRENOS

EMMERRE
spare parts for trucks and trailers

NISSAN

| Applicazioni / Applications | Dettagli / Detail | Adattabile a / Adaptable to | Emmerre |
|-----------------------------|---|-----------------------------|---------------|
| Atleon 120/140 | <ul style="list-style-type: none"> - Assale anteriore/ Front Axle - Esterno/External Ø mm. 282 - Interno/Internal Ø mm. 96 - Altezza fascia/Height band mm. 49 - Spessore/Thickness mm. 24 - 6 Fori/Holes - Fascia autoventilata/Self-Ventilated Band - E11 90R - 02C01165/36670 - E11 90R - 02C01195/38098 | 432069X401 402069X401 | 960057 |



Connessione / Connected:  960875E3  960819

| | | | |
|--|---|--------------------------|---------------|
| Atleon 120/140/165/210 Cabstar 28-35-45 Cabstar E 110/120/75/90 | <ul style="list-style-type: none"> - Assale anteriore/ Front Axle - Esterno/External Ø mm. 290 - Interno/Internal Ø mm. 96 - Altezza fascia/Height band mm. 53 - Spessore/Thickness mm. 26 - 6 Fori/Holes - Fascia autoventilata/Self-Ventilated Band - E11 90R - 02C01165/30136 - E11 90R - 02C01195/26088 | 402069X403 402069X60A | 960522 |
|--|---|--------------------------|---------------|



Connessione / Connected:  960875E3-960459



| | | | |
|---|---|--|---------------|
| Atleon 120 Cabstar 45 Cabstar E 110/120 | <ul style="list-style-type: none"> - Assale posteriore/ Rear Axle - Esterno/External Ø mm. 290 - Interno/Internal Ø mm. 110 - Altezza fascia/Height band mm. 73,50 - Spessore/Thickness mm. 22 - 8 Fori/Holes - Fascia autoventilata/Self-Ventilated Band - Omologazione E11/Homologation E11: - E11 90R - 02C01195/34012 | 432079X100 43206MA50A 402079X100 | 960058 |
|---|---|--|---------------|



Connessione / Connected:  960875E3  960819

| | | | |
|--|--|------------|---------------|
| Interstar DCI 100/120/140/150/80/90 | <ul style="list-style-type: none"> - Assale anteriore/ Front Axle - Esterno/External Ø mm. 305 - Interno/Internal Ø mm. 90 - Altezza fascia/Height band mm. 78 - Spessore/Thickness mm. 28 - 5 Fori/Holes - Fascia autoventilata/Self-Ventilated Band - Omologazione E11/Homologation E11: - E11 90R - 02C01165/37304 - E11 90R - 02C01195/34523 | 4020600QAD | 960233 |
|--|--|------------|---------------|



| Emmerre | Adattabile a / Adaptable to | Dettagli / Detail | Applicazioni / Applications |
|---|-----------------------------|--|--|
| 960231 | 4320600QAA | <ul style="list-style-type: none"> - Assale posteriore/Rear Axle - Esterno/External Ø mm. 305 - Interno/Internal Ø mm. 90 - Altezza fascia/Height band mm. 67 - Spessore/Thickness mm. 12 - 5 Fori/Holes - Fascia piena/Full band <p>- Omologazione E11/Homologation E11: E11 90R - 02C01165/25158</p> | Interstar DCI 100/120/140/150/80/90 |
| Connessione / Connected:  960985E3 | | | |
| 960235 | 06100420-0 | <ul style="list-style-type: none"> - Assale anteriore/Front Axle - Esterno/External Ø mm. 322 - Interno/Internal Ø mm. 160 - Altezza fascia/Height band mm. 115,50 - Spessore/Thickness mm. 30 - 6 Colonnelle/Bolts Ø mm. 18 x 68 - Senza ABS/Without ABS - Fascia autoventilata/Self-Ventilated Band <p>- Omologazione E11/Homologation E11: E11 90R - 02C01047/33949</p> | Atleon 140 Eco L60 Eco L70 Eco T135 |
| 960236 | 06200438-0 | <ul style="list-style-type: none"> - Assale posteriore/Rear Axle - Esterno/External Ø mm. 322 - Interno/Internal Ø mm. 160,20 - Altezza fascia/Height band mm. 115,50 - Spessore/Thickness mm. 30 - 6 Colonnelle/Bolts Ø mm. 18 x 74 - Senza ABS/Without ABS - Fascia autoventilata/Self-Ventilated Band <p>- Omologazione E11/Homologation E11: E11 90R - 02C01047/33949</p> | Atleon 140 Eco L60 Eco L70 Eco T135 |
| Connessione / Connected:  960947E3 | | | |
| 960526 | 402069X407 402069X40A | <ul style="list-style-type: none"> - Assale anteriore e posteriore Front and Rear Axle - Esterno/External Ø mm. 322 - Interno/Internal Ø mm. 160 - Altezza fascia/Height band mm. 115,50 - Spessore/Thickness mm. 30 - 6 Bolts Ø 18x68mm - Con ABS/With ABS - Fascia autoventilata/Self-Ventilated Band <p>- Omologazione E11/Homologation E11: E11 90R - 02C01047/26552</p> | Atleon 140/165 |
| Connessione / Connected:  960947E3 | | | |

DISCHI FRENO
BRAKE DISCS
DISQUES DE FREIN
BREMSSCHEIBEN
ТОРМОЗНЫЕ ДИСКИ
DISCOS DE FRENOS

EMMERRE
spare parts for trucks and trailers

NISSAN

| Applicazioni / Applications | Dettagli / Detail | Adattabile a / Adaptable to | Emmerre |
|---|--|-----------------------------|---------------|
| Atleon 140 (Rear) Atleon 160-165-210 | <ul style="list-style-type: none"> - Assale anteriore e posteriore Front and Rear Axle - Esterno/External Ø mm. 322 - Interno/Internal Ø mm. 160,20 - Altezza fascia/Height band mm. 115,50 - Spessore/Thickness mm. 30 - 6 Colonnelle/Bolts Ø mm. 18 x 74 - Con ABS/With ABS - Fascia autoventilata/Self-Ventilated Band - Omologazione E11/Homologation E11: E11 90R - 02C01047/33949 | 402069X001 402069X405 | 960527 |
| Connessione / Connected:  960947E3 | | | |
| Atleon TK | <ul style="list-style-type: none"> - Assale anteriore/Front Axle - Esterno/External Ø mm. 322 - Interno/Internal Ø mm. 160 - Altezza fascia/Height band mm. 115,50 - Spessore/Thickness mm. 30 - 6 Colonnelle/Bolts Ø mm. 18 x 68 - Con ABS/With ABS - Fascia autoventilata/Self-Ventilated Band - Omologazione E11/Homologation E11: E11 90R - 02C01047/26552 | 402069X000 | 960062 |
| Connessione / Connected:  960947E3 | | | |
| Eco T160 Atleon 165 | <ul style="list-style-type: none"> - Assale anteriore e posteriore Front and Rear Axle - Esterno/External Ø mm. 380 - Interno/Internal Ø mm. 158 - Altezza fascia/Height band mm. 124 - Spessore/Thickness mm. 45 - 12 Fori/Holes - Fascia autoventilata/Self-Ventilated Band - Omologazione E11/Homologation E11: E11 90R - 02C01047/29170 | 40206D9200 | 960054 |
| Connessione / Connected:  960947E3 | | | |
| NV 400 | <ul style="list-style-type: none"> - Assale posteriore/Rear Axle - Esterno/External Ø mm. 302 - Interno/Internal Ø mm. 120 - Altezza fascia/Height band mm. 51 - Spessore/Thickness mm. 18 - 8 Fori/Holes - Fascia piena/Full band | 4320600Q0C | 960472 |

| Emmerre | Adattabile a / <i>Adaptable to</i> | Dettagli / <i>Detail</i> | Applicazioni / <i>Applications</i> |
|--|------------------------------------|---|------------------------------------|
| <p>960473</p>  | <p>4320600Q0A</p> | <ul style="list-style-type: none"> - Assale posteriore/Rear Axle - Esterno/<i>External</i> Ø mm. 305 - Interno/<i>Internal</i> Ø mm. 90 - Altezza fascia/<i>Height band</i> mm. 71,5 - Spessore/<i>Thickness</i> mm. 12 <ul style="list-style-type: none"> - 5 Fori/<i>Holes</i> - Fascia piena/<i>Full band</i> | <p>NV 400</p> |
| | | | |
| | | | |
| | | | |

DISCHI FRENO
BRAKE DISCS
DISQUES DE FREIN
BREMSSCHEIBEN
ТОРМОЗНЫЕ ДИСКИ
DISCOS DE FRENOS

EMMERRE
spare parts for trucks and trailers

OPEL

| Applicazioni / Applications | Dettagli / Detail | Adattabile a / Adaptable to | Emmerre |
|---|--|--|---------------|
| Movano B. Furgone Movano Bus | <ul style="list-style-type: none"> - Assale anteriore/ Front Axle - Esterno/External Ø mm. 302 - Interno/Internal Ø mm. 90 - Altezza fascia/Height band mm. 70 - Spessore/Thickness mm. 28 - 5 Fori/Holes Fascia autoventilata/Self-Ventilated Band - Omologazione E11/Homologation E11: E11 90R - 02C01195/34523 | 4419359 | 960192 |
| | |  | |
| Movano Combi Furgonato Ribaltabile | <ul style="list-style-type: none"> - Assale anteriore/ Front Axle - Esterno/External Ø mm. 280 - Interno/Internal Ø mm. 79,50 - Altezza fascia/Height band mm. 61,50 - Spessore/Thickness mm. 24 - 6 Fori/Holes - Fascia autoventilata/Self-Ventilated Band - Omologazione E11/Homologation E11: E11 90R - 02C01165/36670 E11 90R - 02C01195/38098 | 9160398 4500098 | 960234 |
| | |  | |
| Connessione / Connected:  960947E3 | | | |
| Movano B Furgonato | <ul style="list-style-type: none"> - Assale posteriore/Rear Axle - Esterno/External Ø mm. 302 - Interno/Internal Ø mm. 120 - Altezza fascia/Height band mm. 51 - Spessore/Thickness mm. 18 - 8 Fori/Holes - Fascia piena/Full band | 4421180 | 960472 |
| | |  | |
| Connessione / Connected:  960947E3 | | | |
| Movano Bus Movano B Furgonato | <ul style="list-style-type: none"> - Assale posteriore/Rear Axle - Esterno/External Ø mm. 305 - Interno/Internal Ø mm. 90 - Altezza fascia/Height band mm. 71,50 - Spessore/Thickness mm. 12 - 5 Fori/Holes - Fascia piena/Full band | 4419362 | 960473 |
| | |  | |
| Connessione / Connected:  960947E3 | | | |

| Emmerre | Adattabile a / Adaptable to | Dettagli / Detail | Applicazioni / Applications |
|---|-----------------------------|---|-----------------------------------|
| 960234 | 7700302128 | <ul style="list-style-type: none"> - Assale anteriore/ Front Axle - Esterno/External Ø mm. 280 - Interno/Internal Ø mm. 79,50 - Altezza fascia/Height band mm. 61,50 - Spessore/Thickness mm. 24 <li style="padding-left: 20px;">- 6 Fori/Holes - Fascia autoventilata/Self-Ventilated Band - E11 90R - 02C01165/36670 - E11 90R - 02C01195/38098 | Master Master II |
| Connessione / Connected:  960986 | | | |
| 960472 | 7485124209 432067943R | <ul style="list-style-type: none"> - Assale posteriore/Rear Axle - Esterno/External Ø mm. 302 - Interno/Internal Ø mm. 120 - Altezza fascia/Height band mm. 51 - Spessore/Thickness mm. 18 <li style="padding-left: 20px;">- 8 Fori/Holes - Fascia piena/Full band | Master Master IV |
| Connessione / Connected:  960790 | | | |
| 960233 | 7700314064 5001875373 | <ul style="list-style-type: none"> - Assale anteriore/ Front Axle - Esterno/External Ø mm. 305 - Interno/Internal Ø mm. 90 - Altezza fascia/Height band mm. 78 - Spessore/Thickness mm. 28 <li style="padding-left: 20px;">- 5 Fori/Holes - Fascia autoventilata/Self-Ventilated Band - E11 90R - 02C01165/37304 - E11 90R - 02C01195/34523 | Master Master II Master III |
| Connessione / Connected:  960988E3 | | | |
| 960473 | 7485120668 432000367R | <ul style="list-style-type: none"> - Assale posteriore/Rear Axle - Esterno/External Ø mm. 305 - Interno/Internal Ø mm. 90 - Altezza fascia/Height band mm. 71,50 - Spessore/Thickness mm. 12 <li style="padding-left: 20px;">- 5 Fori/Holes - Fascia piena/Full band | Master III Master IV |
| Connessione / Connected:  960791 | | | |

DISCHI FRENO
BRAKE DISCS
DISQUES DE FREIN
BREMSSCHEIBEN
ТОРМОЗНЫЕ ДИСКИ
DISCOS DE FRENOS

EMMERRE
spare parts for trucks and trailers

Dischi Freno
Brake Discs

RENAULT

| Applicazioni / Applications | Dettagli / Detail | Adattabile a / Adaptable to | Emmerre |
|-----------------------------------|---|-----------------------------|---------------|
| Master Master II Master III | <ul style="list-style-type: none"> - Assale posteriore/Rear Axle - Esterno/External Ø mm. 305 - Interno/Internal Ø mm. 90 - Altezza fascia/Height band mm. 67 - Spessore/Thickness mm. 12 - 5 Fori/Holes - Fascia piena/Full band - Omologazione E11/Homologation E11: E11 90R - 02C01165/25158 | 7700314107 5001875375 | 960231 |



Connessione / Connected:  960985E3

| | | | |
|------------|--|------------|---------------|
| Master III | <ul style="list-style-type: none"> - Assale anteriore/Front Axle - Esterno/External Ø mm. 302 - Interno/Internal Ø mm. 90 - Altezza fascia/Height band mm. 70 - Spessore/Thickness mm. 28 - 5 Fori/Holes - Fascia autoventilata/Self-Ventilated Band - Omologazione E11/Homologation E11: E11 90R - 02C01195/34523 | 8200688880 | 960192 |
|------------|--|------------|---------------|



Connessione / Connected:  960791

| | | | |
|--|--|--------------------------|---------------|
| Master II Phase1 Master II Phase2 Master II Phase3 Maxity 4.5 Ton 130.45 150.45 | <ul style="list-style-type: none"> - Assale posteriore/Rear Axle - Esterno/External Ø mm. 290 - Interno/Internal Ø mm. 110 - Altezza fascia/Height band mm. 73,50 - Spessore/Thickness mm. 22 - 8 Fori/Holes - Fascia autoventilata/Self-Ventilated Band - Omologazione E11/Homologation E11: E11 90R - 02C01195/34012 | 7485115090 5001871282 | 960058 |
|--|--|--------------------------|---------------|



Connessione / Connected:  960786

| | | | |
|----------------|---|------------|---------------|
| Maxity 3.5 Ton | <ul style="list-style-type: none"> - Assale posteriore/Rear Axle - Esterno/External Ø mm. 280 - Interno/Internal Ø mm. 108 - Altezza fascia/Height band mm. 62 - Spessore/Thickness mm. 16 - 6 Fori/Holes - Senza ABS/Without ABS - Fascia piena/Full band - Omologazione E11/Homologation E11: E11 90R - 02C01165/24893 | 5001874635 | 960458 |
|----------------|---|------------|---------------|



Connessione / Connected:  960459

I riferimenti indicati non sono originali ma perfettamente intercambiabili. I codici originali e le case costruttrici sono indicati a puro titolo informativo
The details described are not original but perfectly interchangeable. The original references and manufacturer names are given for information purposes only.

EMMERRE

spare parts for trucks and trailers

RENAULT

DISCHI FRENO
BRAKE DISCS
DISQUES DE FREIN
BREMSSCHEIBEN
ТОРМОЗНЫЕ ДИСКИ
DISCOS DE FRENOS

| Emmerre | Adattabile a / Adaptable to | Dettagli / Detail | Applicazioni / Applications |
|---|-----------------------------|---|-----------------------------|
| 960460  | 5001871281 | <ul style="list-style-type: none">- Assale posteriore/Rear Axle- Esterno/External Ø mm. 280- Interno/Internal Ø mm. 108- Altezza fascia/Height band mm. 67- Spessore/Thickness mm. 16<ul style="list-style-type: none">- 6 Fori/Holes- Con ABS/With ABS- Fascia piena/Full band | Maxity 3.5 Ton |
| Connessione / Connected:  960459 | | | |
| 960462  | 5001871213 | <ul style="list-style-type: none">- Assale anteriore/Front Axle- Esterno/External Ø mm. 276- Interno/Internal Ø mm. 94- Altezza fascia/Height band mm. 45- Spessore/Thickness mm. 28<ul style="list-style-type: none">- 5 Fori/Holes- Fascia autoventilata/Self-Ventilated Band- Omologazione E11/Homologation E11: E11 90R - 02C01165/30134 | Maxity 3.5 Ton |
| Connessione / Connected:  960461 | | | |
| 960522  | 5001871214 | <ul style="list-style-type: none">- Assale anteriore/Front Axle- Esterno/External Ø mm. 290- Interno/Internal Ø mm. 96- Altezza fascia/Height band mm. 53- Spessore/Thickness mm. 26<ul style="list-style-type: none">- 6 Fori/Holes- Fascia autoventilata/Self-Ventilated Band- Omologazione E11/Homologation E11: E11 90R - 02C01165/30136 E11 90R - 02C01195/26088 | Maxity 130/150.45 |
| Connessione / Connected:  960875E3-960459 | | | |
| 960209  | 7420924727 | <ul style="list-style-type: none">- Assale anteriore/Front Axle- Esterno/External Ø mm. 290- Interno/Internal Ø mm. 73- Altezza fascia/Height band mm. 77- Spessore/Thickness mm. 26<ul style="list-style-type: none">- 10 Fori/Holes- Fascia autoventilata/Self-Ventilated Band- Omologazione E11/Homologation E11: E11 90R - 02C01165/30136 | Mascott |
| Connessione / Connected:  960987E3-960972E3  960819 | | | |

DISCHI FRENO
BRAKE DISCS
DISQUES DE FREIN
BREMSSCHEIBEN
ТОРМОЗНЫЕ ДИСКИ
DISCOS DE FRENOS

EMMERRE
spare parts for trucks and trailers

Dischi Freno
Brake Discs

RENAULT

| Applicazioni / Applications | Dettagli / Detail | Adattabile a / Adaptable to | Emmerre |
|---|---|-----------------------------|---------------|
| Mascott | <ul style="list-style-type: none"> - Assale anteriore/ Front Axle - Esterno/External Ø mm. 290 - Interno/Internal Ø mm. 73 - Altezza fascia/Height band mm. 77 - Spessore/Thickness mm. 22 - 10 Fori/Holes - Fascia autoventilata/Self-Ventilated Band - Omologazione E11/Homologation E11: E11 90R - 02C01195/34012 | 7420924728 | 960198 |
| Connessione / Connected:  960987E3 | | | |
| Mascott 110/120/130/140 150/160 90 | <ul style="list-style-type: none"> - Assale anteriore/ Front Axle - Esterno/External Ø mm. 290 - Interno/Internal Ø mm. 102 - Altezza fascia/Height band mm. 42,50 - Spessore/Thickness mm. 22 - 10 Fori/Holes - Fascia autoventilata/Self-Ventilated Band - Omologazione E11/Homologation E11: E11 90R - 02C01165/30136 E11 90R - 02C01195/34012 | 5010260604 | 960230 |
| Connessione / Connected:  960987E3-960972E3  960819 | | | |
| Mascott 110/120/130/140 150/160 90 | <ul style="list-style-type: none"> - Assale posteriore/ Rear Axle - Esterno/External Ø mm. 290 - Interno/Internal Ø mm. 115 - Altezza fascia/Height band mm. 73,50 - Spessore/Thickness mm. 22 - 8 Fori/Holes - Fascia autoventilata/Self-Ventilated Band - Omologazione E11/Homologation E11: E11 90R - 02C01195/34012 | 5010260609 5001864712 | 960229 |
| Connessione / Connected:  960987E3-960972E3  960819 | | | |
| Mascott 110/120/130/140 150/160 90 | <ul style="list-style-type: none"> - Assale anteriore/ Front Axle - Esterno/External Ø mm. 290 - Interno/Internal Ø mm. 102 - Altezza fascia/Height band mm. 42,50 - Spessore/Thickness mm. 26 - 10 Fori/Holes - Fascia autoventilata/Self-Ventilated Band - Omologazione E11/Homologation E11: E11 90R - 02C01165/30136 E11 90R - 02C01195/26088 | 5010260603 | 960392 |
| Connessione / Connected:  960987E3-960972E3  960819 | | | |

I riferimenti indicati non sono originali ma perfettamente intercambiabili. I codici originali e le case costruttrici sono indicati a puro titolo informativo
The details described are not original but perfectly interchangeable. The original references and manufacturer names are given for information purposes only.

| Emmerre | Adattabile a / Adaptable to | Dettagli / Detail | Applicazioni / Applications |
|---------------|-----------------------------|---|-------------------------------------|
| 960342 | 5010216433 | <ul style="list-style-type: none"> - Assale anteriore/ Front Axle - Esterno/External Ø mm. 276 - Interno/Internal Ø mm. 102 - Altezza fascia/Height band mm. 44 - Spessore/Thickness mm. 24 - 10 Fori/Holes - Fascia autoventilata/Self-Ventilated Band | Midliner Messenger Bus |
| | | Connessione / Connected:  960959E3  960919 | |
| 960305 | 5000396612 | <ul style="list-style-type: none"> - Assale anteriore/ Front Axle - Esterno/External Ø mm. 276 - Interno/Internal Ø mm. 95 - Altezza fascia/Height band mm. 44 - Spessore/Thickness mm. 24 - 10 Fori/Holes - Fascia autoventilata/Self-Ventilated Band | Midliner Messenger Bus |
| | | Connessione / Connected:  960959E3  960919 | |
| 960199 | 5010260101 5010216931 | <ul style="list-style-type: none"> - Assale anteriore/ Front Axle - Esterno/External Ø mm. 304 - Interno/Internal Ø mm. 205 - Altezza fascia/Height band mm. 135 - Spessore/Thickness mm. 30 - 6 Fori/Holes - Fascia autoventilata/Self-Ventilated Band | Midliner M/S for axles type E402 |
| | | Connessione / Connected:  960939E3  960918 | |
| 960227 | 5010260102 5010216932 | <ul style="list-style-type: none"> - Assale anteriore/ Front Axle - Esterno/External Ø mm. 322 - Interno/Internal Ø mm. 215 - Altezza fascia/Height band mm. 140 - Spessore/Thickness mm. 30 - 6 Fori/Holes - Fascia autoventilata/Self-Ventilated Band | Midliner M/S for axles type E401 |
| | | Connessione / Connected:  960939E3  960918 | |

DISCHI FRENO
BRAKE DISCS
DISQUES DE FREIN
BREMSSCHEIBEN
ТОРМОЗНЫЕ ДИСКИ
DISCOS DE FRENOS

EMMERRE
spare parts for trucks and trailers

RENAULT

| Applicazioni / Applications | Dettagli / Detail | Adattabile a / Adaptable to | Emmerre |
|---|---|--|---------------|
| Midliner M/S for axles type E400 | <ul style="list-style-type: none"> - Assale anteriore/ Front Axle - Esterno/External Ø mm. 354 - Interno/Internal Ø mm. 128 - Altezza fascia/Height band mm. 82 - Spessore/Thickness mm. 30 - 10 Fori/Holes - Fascia autoventilata/Self-Ventilated Band | 5000450158 5000545242 | 960308 |
| Connessione / Connected:  960918 | | | |
| Midliner Midlum 135/150/180 210/220/250/270 | <ul style="list-style-type: none"> - Assale anteriore/ Front Axle - Esterno/External Ø mm. 380 - Interno/Internal Ø mm. 117 - Altezza fascia/Height band mm. 85 - Spessore/Thickness mm. 45 - 10 Fori/Holes - Fascia autoventilata/Self-Ventilated Band - Omologazione E11/Homologation E11: E11 90R - 02C01165/33910 | 5010260218 | 960228 |
| Connessione / Connected:  960939E3  960918 | | | |
| Midlum 135/150/160/180 190/210/220/240/250 | <ul style="list-style-type: none"> - Assale anteriore/ Front Axle - Esterno/External Ø mm. 330 - Interno/Internal Ø mm. 95 - Altezza fascia/Height band mm. 80 - Spessore/Thickness mm. 34 - 10 Fori/Holes - Fascia autoventilata/Self-Ventilated Band - Omologazione E11/Homologation E11: E11 90R - 02C01165/33946 | 5010525308 5010422262 5010598303 | 960237 |
| Connessione / Connected:  960939E3-960270-960272E3  960806-960440 | | | |
| Midlum 135/150 | <ul style="list-style-type: none"> - Assale posteriore/ Rear Axle - Esterno/External Ø mm. 329,50 - Interno/Internal Ø mm. 194 - Altezza fascia/Height band mm. 137 - Spessore/Thickness mm. 34 - 6 Fori/Holes - Con ABS/With ABS - Fascia autoventilata/Self-Ventilated Band - Omologazione E11/Homologation E11: E11 90R - 02C01165/33946 | 5010422263 7421866443 | 960238 |
| Connessione / Connected:  960939E3-960270-960272E3  960806-960440 | | | |

I riferimenti indicati non sono originali ma perfettamente intercambiabili. I codici originali e le case costruttrici sono indicati a puro titolo informativo
The details described are not original but perfectly interchangeable. The original references and manufacturer names are given for information purposes only.

EMMERRE

spare parts for trucks and trailers

RENAULT

DISCHI FRENO
BRAKE DISCS
DISQUES DE FREIN
BREMSSCHEIBEN
ТОРМОЗНЫЕ ДИСКИ
DISCOS DE FRENOS

| Emmerre | Adattabile a / Adaptable to | Dettagli / Detail | Applicazioni / Applications |
|---|--|--|--|
| 960197  | 5010598304 | <ul style="list-style-type: none">- Assale posteriore/Rear Axle- Esterno/External Ø mm. 330- Interno/Internal Ø mm. 194- Altezza fascia/Height band mm. 137- Spessore/Thickness mm. 34- 6 Fori/Holes- Fascia autoventilata/Self-Ventilated Band- Omologazione E11/Homologation E11: E11 90R - 02C01047/21145 | Midlum 160/190/220/240/280 |
| Connessione / Connected:  960969E3 | | | |
| 960239  | 7421867375 5010525014 | <ul style="list-style-type: none">- Assale anteriore/Front Axle- Esterno/External Ø mm. 375- Interno/Internal Ø mm. 117- Altezza fascia/Height band mm. 99- Spessore/Thickness mm. 45- 10 Fori/Holes- Fascia autoventilata/Self-Ventilated Band- Omologazione E11/Homologation E11: E11 90R - 02C01165/33910 | Midlum 135/150/180/210 220/250/270 |
| Connessione / Connected:  960939E3-960270-960272E3  960806-960440 | | | |
| 960240  | 7482421131 5010598306 5010525362 5010525015 | <ul style="list-style-type: none">- Assale posteriore/Rear Axle- Esterno/External Ø mm. 375- Interno/Internal Ø mm. 222- Altezza fascia/Height band mm. 166,50- Spessore/Thickness mm. 45- 8 Fori/Holes- Fascia autoventilata/Self-Ventilated Band- Omologazione E11/Homologation E11: E11 90R - 02C01165/33910 | Midlum 160/190/220/240/280 |
| Connessione / Connected:  960969E3-960823-960272E3  960806-960440 | | | |
| 960242  | 5010525364 | <ul style="list-style-type: none">- Assale posteriore/Rear Axle- Esterno/External Ø mm. 375- Interno/Internal Ø mm. 262- Altezza fascia/Height band mm. 166,50- Spessore/Thickness mm. 45- 10 Fori/Holes- Fascia autoventilata/Self-Ventilated Band- Omologazione E11/Homologation E11: E11 90R - 02C01165/33910 | Midlum 135/150/180 210/220/250/270/280 |
| Connessione / Connected:  960939E3-960270-960272E3  960806-960440 | | | |

DISCHI FRENO
BRAKE DISCS
DISQUES DE FREIN
BREMSSCHEIBEN
ТОРМОЗНЫЕ ДИСКИ
DISCOS DE FRENOS

EMMERRE
spare parts for trucks and trailers

Dischi Freno
Brake Discs

RENAULT

| Applicazioni / Applications | Dettagli / Detail | Adattabile a / Adaptable to | Emmerre |
|---|---|--|---------------|
| Midlum 160/190/220/240/280 | <ul style="list-style-type: none"> - Assale posteriore/Rear Axle - Esterno/External Ø mm. 375 - Interno/Internal Ø mm. 262 - Altezza fascia/Height band mm. 166,50 - Spessore/Thickness mm. 45 - 10 Fori/Holes - Fascia autoventilata/Self-Ventilated Band - Omologazione E11/Homologation E11: E11 90R - 02C01047/21144 | 5010598307 | 960482 |
| Connessione / Connected:  960272E3-960999E3 | | | |
| Midlum 160.08 -10-12 190.08 -10-12-13-14 220.08 -10-12-13-14 240.12 -13-14-15-16-18 280.12 -13-14-16-18 | <ul style="list-style-type: none"> - Assale posteriore/Rear Axle - Esterno/External Ø mm. 410 - Interno/Internal Ø mm. 262 - Altezza fascia/Height band mm. 166,50 - Spessore/Thickness mm. 45 - 10 Fori/Holes - Fascia autoventilata/Self-Ventilated Band - Omologazione E11/Homologation E11: E11 90R - 02C01047/26554 | 5010598309 | 960475 |
| Connessione / Connected:  960270  960434-960804 | | | |
| Major R340/R350/R380 /R385/R420 Magnum 385/420/520 Manager 200/230/270/280 300/330/340 | <ul style="list-style-type: none"> - Assale anteriore/Front Axle - Esterno/External Ø mm. 440 - Interno/Internal Ø mm. 131 - Altezza fascia/Height band mm. 100 - Spessore/Thickness mm. 45 - 10 Fori/Holes - Fascia autoventilata/Self-Ventilated Band - E11 90R - 02C01195/33250 E11 90R - 02C01165/33263 | 5010216548 5000792539 | 960306 |
| Connessione / Connected:  960958  960917 | | | |
| R310.16 R310.17 R310.22 | <ul style="list-style-type: none"> - Assale anteriore e posteriore Front and Rear Axle - Esterno/External Ø mm. 350 - Interno/Internal Ø mm. 145 - Altezza fascia/Height band mm. 73 - Spessore/Thickness mm. 30 - 16 Fori/Holes - Fascia autoventilata/Self-Ventilated Band | 5010019249 5010207431 5010190865 5010216431 | 960191 |
| Connessione / Connected:  961049 | | | |

I riferimenti indicati non sono originali ma perfettamente intercambiabili. I codici originali e le case costruttrici sono indicati a puro titolo informativo
The details described are not original but perfectly interchangeable. The original references and manufacturer names are given for information purposes only.

| Emmerre | Adattabile a / Adaptable to | Dettagli / Detail | Applicazioni / Applications |
|--|--|---|--|
| 960193 | 5010598308 | <ul style="list-style-type: none"> - Assale anteriore/ Front Axle - Esterno/External Ø mm. 410 - Interno/Internal Ø mm. 131 - Altezza fascia/Height band mm. 93 - Spessore/Thickness mm. 45 <li style="padding-left: 20px;">- 10 Fori/Holes - Fascia autoventilata/Self-Ventilated Band - Omologazione E11/Homologation E11: E11 90R - 02C01047/26553 | Midlum 160.08 -10-12 190.08 -10-12-13-14 220.08 -10-12-13-14 240.12 -13-14-15-16-18 280.12 -13-14-16-18 |
| Connessione / Connected:  960823 | | | |
| 960481 | 5010598305 | <ul style="list-style-type: none"> - Assale anteriore/ Front Axle - Esterno/External Ø mm. 375 - Interno/Internal Ø mm. 142 - Altezza fascia/Height band mm. 119 - Spessore/Thickness mm. 45 <li style="padding-left: 20px;">- 10 Fori/Holes - Fascia autoventilata/Self-Ventilated Band - Omologazione E11/Homologation E11: E11 90R - 02C01047/21144 | Midlum 160/190/220/240/280 |
| Connessione / Connected:  960823 | | | |
| 960307 | 5010216437 | <ul style="list-style-type: none"> - Assale anteriore/ Front Axle - Esterno/External Ø mm. 438 - Interno/Internal Ø mm. 131 - Altezza fascia/Height band mm. 96,60 - Spessore/Thickness mm. 45 <li style="padding-left: 20px;">- 10 Fori/Holes - Fascia autoventilata/Self-Ventilated Band - Omologazione E11/Homologation E11: E11 90R - 02C01195/33250 E11 90R - 02C01165/33263 | Magnum 385/420/520 Premium Distribution Premium Route |
| Connessione / Connected:  960956E1-960956E3-960982E3  960814-960933-960977 | | | |
| 960500 | 7482194787 5010422593 5010422363 | <ul style="list-style-type: none"> - Assale anteriore/ Front Axle - Esterno/External Ø mm. 434 - Interno/Internal Ø mm. 131 - Altezza fascia/Height band mm. 97 - Spessore/Thickness mm. 45 <li style="padding-left: 20px;">- 10 Fori/Holes - Fascia autoventilata/Self-Ventilated Band - Omologazione E11/Homologation E11: E11 90R - 02C01047/26550 | Magnum 400/440/480 Premium Distribution Premium Route |
| Connessione / Connected:  960983E3  960434-960804-960814 | | | |

DISCHI FRENO
BRAKE DISCS
DISQUES DE FREIN
BREMSSCHEIBEN
ТОРМОЗНЫЕ ДИСКИ
DISCOS DE FRENOS

EMMERRE
spare parts for trucks and trailers

Dischi Freno
Brake Discs





RENAULT

| Applicazioni / Applications | Dettagli / Detail | Adattabile a / Adaptable to | Emmerre |
|---|---|-----------------------------|---------------|
| Magnum 400/440/480 E-Tech | <ul style="list-style-type: none"> - Assale posteriore/Rear Axle - Esterno/External Ø mm. 434 - Interno/Internal Ø mm. 224 - Altezza fascia/Height band mm. 160 - Spessore/Thickness mm. 45 - 12 Fori/Holes - Fascia piena/Full band | 5010422364 | 960226 |
| Connessione / Connected:  960983E3  960434-960804-960814 | | | |
| Premium Magnum 400/440/480 | <ul style="list-style-type: none"> - Assale posteriore/Rear Axle - Esterno/External Ø mm. 434 - Interno/Internal Ø mm. 260 - Altezza fascia/Height band mm. 163 - Spessore/Thickness mm. 45 - 10 Fori/Holes - Fascia piena/Full band | 5010525326 | 960464 |
| Connessione / Connected:  960983E3  960804 | | | |
| Magnum DXI 12 Magnum DXI 13 Premium Distribution II Premium Route II | <ul style="list-style-type: none"> - Assale anteriore e posteriore Front and Rear Axle - Esterno/External Ø mm. 434 - Interno/Internal Ø mm. 220 - Altezza fascia/Height band mm. 45 - Spessore/Thickness mm. 45 - 24 Denti/Teeth - Fascia autoventilata/Self-Ventilated Band - Omologazione E11/Homologation E11: E11 90R - 02C01047/26548 | 7421575117 5001864498 | 960225 |
| Connessione / Connected:  960989E1-960989E3-960394E3  960434-960804 | | | |
| Magnum DXI Premium Midlum DXI | <ul style="list-style-type: none"> - Assale posteriore/Rear Axle - Esterno/External Ø mm. 410 - Interno/Internal Ø mm. 220 - Altezza fascia/Height band mm. 45 - Spessore/Thickness mm. 45 - 24 Denti/Teeth - Fascia autoventilata/Self-Ventilated Band - Omologazione E11/Homologation E11: E11 90R - 02C01047/26555 | 5001867798 | 960218 |
| Connessione / Connected:  960989E3 - 960989E1  960434 | | | |

EMMERRE
MODIFICATION

EMMERRE
MODIFICATION

I riferimenti indicati non sono originali ma perfettamente intercambiabili. I codici originali e le case costruttrici sono indicati a puro titolo informativo
The details described are not original but perfectly interchangeable. The original references and manufacturer names are given for information purposes only.

| Emmerre | Adattabile a / Adaptable to | Dettagli / Detail | Applicazioni / Applications |
|---|-----------------------------|---|--|
| 960140  | 5010525508 | <ul style="list-style-type: none"> - Assale posteriore/Rear Axle - Esterno/External Ø mm. 434 - Interno/Internal Ø mm. 264 - Altezza fascia/Height band mm. 170 - Spessore/Thickness mm. 45 <ul style="list-style-type: none"> - 10 Fori/Holes - Fascia piena/Full Band | Midlum |
| | | Connessione / Connected:  960983E3 |  960804 |
| 960483  | 7485141535 | <ul style="list-style-type: none"> - Assale anteriore/Front Axle - Esterno/External Ø mm. 276 - Interno/Internal Ø mm. 120 - Altezza fascia/Height band mm. 45 - Spessore/Thickness mm. 28 <ul style="list-style-type: none"> - 6 Fori/Holes - Fascia autoventilata/Self-Ventilated Band | Maxity |
| | | Connessione / Connected:  960787 | |

DISCHI FRENO
BRAKE DISCS
DISQUES DE FREIN
BREMSSCHEIBEN
ТОРМОЗНЫЕ ДИСКИ
DISCOS DE FRENOS

EMMERRE
spare parts for trucks and trailers

Dischi Freno
Brake Discs

ROR

| Applicazioni / Applications | Dettagli / Detail | Adattabile a / Adaptable to | Emmerre |
|--|--|---------------------------------|---------------|
| C-DUCO | <ul style="list-style-type: none"> - Esterno/External Ø mm. 336 - Interno/Internal Ø mm. 215 - Altezza fascia/Height band mm. 139 - Spessore/Thickness mm. 30 - 8 Fori/Holes - Fascia piena/Full band | MBR9003 | 960474 |
| Connessione / Connected:  960430 | | | |
| ROR Axle | <ul style="list-style-type: none"> - Esterno/External Ø mm. 375 - Interno/Internal Ø mm. 169 - Altezza fascia/Height band mm. 138 - Spessore/Thickness mm. 45 - 8 Fori/Holes - Fascia autoventilata/Self-Ventilated Band - Con ABS/With ABS - Omologazione E11/Homologation E11: E11 90R - 02C01047/21144 | MBR5186 13162047 658622 | 960445 |
| Connessione / Connected:  960430 | | | |
| C-DUCO TA TC | <ul style="list-style-type: none"> - Assale anteriore/Front Axle - Esterno/External Ø mm. 375 - Interno/Internal Ø mm. 105,60 - Altezza fascia/Height band mm. 116 - Spessore/Thickness mm. 45 - 14 Fori/Holes - Fascia piena/Full band | MBR9000 | 960683 |
| Connessione / Connected:  960347 | | | |
| B-DUCO Elsa 195 | <ul style="list-style-type: none"> - Esterno/External Ø mm. 375 - Interno/Internal Ø mm. 225 - Altezza fascia/Height band mm. 157 - Spessore/Thickness mm. 45 - 8 Fori/Holes - Con ABS/With ABS - Fascia piena/Full band - <i>C-DUCO System</i> | MBR9001 68323233 68323210 | 960350 |
| Connessione / Connected:  960394E3  960525 | | | |



| Emmerre | Adattabile a / Adaptable to | Dettagli / Detail | Applicazioni / Applications |
|---------------|--------------------------------------|--|-----------------------------|
| 960351 | MBR9014 68325372 | <ul style="list-style-type: none"> - Esterno/External Ø mm. 376,50 - Interno/Internal Ø mm. 225 - Altezza fascia/Height band mm. 150 - Spessore/Thickness mm. 45 <li style="padding-left: 20px;">- 8 Fori/Holes <li style="padding-left: 20px;">- Con ABS/With ABS - Fascia autoventilata/Self-Ventilated Band B-DUCO System - Omologazione E11/Homologation E11: E11 90R - 02C01047/29169 | ROR Axle Elsa 195 |
| | | Connessione / Connected:  960394E3  960525 | |
| 960110 | MBR9018 MBR5073 21227349 | <ul style="list-style-type: none"> - Esterno/External Ø mm. 378 - Interno/Internal Ø mm. 222 - Altezza fascia/Height band mm. 150 - Spessore/Thickness mm. 45 <li style="padding-left: 20px;">- 10 Fori/Holes <li style="padding-left: 20px;">- Con ABS/With ABS - Fascia autoventilata/Self-Ventilated Band - Omologazione E11/Homologation E11: E11 90R - 02C01047/29169 | LM LMC TM |
| | | Connessione / Connected:  960928E3  960525 | |
| 960301 | MBR9017 21224263 | <ul style="list-style-type: none"> - Esterno/External Ø mm. 378 - Interno/Internal Ø mm. 225 - Altezza fascia/Height band mm. 150 - Spessore/Thickness mm. 45 <li style="padding-left: 20px;">- 8 Fori/Holes <li style="padding-left: 20px;">- Senza ABS/Without ABS - Fascia autoventilata/Self-Ventilated Band - Omologazione E11/Homologation E11: E11 90R - 02C01047/29170 | LM TM |
| | | Connessione / Connected:  960928E3  960525 | |
| 960119 | 21225115 31788700100 3218G1333 | <ul style="list-style-type: none"> - Esterno/External Ø mm. 378 - Interno/Internal Ø mm. 222 - Altezza fascia/Height band mm. 150 - Spessore/Thickness mm. 45 <li style="padding-left: 20px;">- 10 Fori/Holes <li style="padding-left: 20px;">- Senza ABS/Without ABS - Fascia autoventilata/Self-Ventilated Band | LM LMC |
| | | Connessione / Connected:  960928E3  960525 | |

DISCHI FRENO
BRAKE DISCS
DISQUES DE FREIN
BREMSSCHEIBEN
ТОРМОЗНЫЕ ДИСКИ
DISCOS DE FRENOS

EMMERRE
spare parts for trucks and trailers

Dischi Freno
Brake Discs

ROR

| Applicazioni / Applications | Dettagli / Detail | Adattabile a / Adaptable to | Emmerre |
|-----------------------------|--|--------------------------------|---------------|
| LM TA D-DUCO | <ul style="list-style-type: none"> - Esterno/External Ø mm. 434 - Interno/Internal Ø mm. 222 - Altezza fascia/Height band mm. 150 - Spessore/Thickness mm. 45 - 10 Fori/Holes - Con ABS/With ABS - Fascia autoventilata/Self-Ventilated Band Meritor System -D-Elsa 2 - Omologazione E11/Homologation E11: E11 90R - 02C01047/26550 | MBR9004 MBR5124 68323825 | 960300 |



Connessione / Connected: 970007E3-960993E3

| | | | |
|--------------------|--|---------------------|---------------|
| ROR Axle Elsa 2 | <ul style="list-style-type: none"> - Assale posteriore/Rear Axle - Esterno/External Ø mm. 434 - Interno/Internal Ø mm. 260 - Altezza fascia/Height band mm. 163 - Spessore/Thickness mm. 45 - 10 Fori/Holes - Fascia piena/Full band | MBR9011 68323740 | 960464 |
|--------------------|--|---------------------|---------------|



Connessione / Connected: 960983E3 960804

| | | | |
|----------|--|------------------------|---------------|
| ROR Axle | <ul style="list-style-type: none"> - Esterno/External Ø mm. 434 - Interno/Internal Ø mm. 210 - Altezza fascia/Height band mm. 138,50 - Spessore/Thickness mm. 45 - 12 Fori/Holes - Con ABS/With ABS - Fascia autoventilata/Self-Ventilated Band | 3218F1514 3218P1342 | 960490 |
|----------|--|------------------------|---------------|



| | | | |
|--------|---|---------------------|---------------|
| B-DUCO | <ul style="list-style-type: none"> - Esterno/External Ø mm. 336,5 - Interno/Internal Ø mm. 91,5 - Altezza fascia/Height band mm. 100 - Spessore/Thickness mm. 30 - 10 Fori/Holes - Fascia piena/Full band | MBR9002 68323231 | 960417 |
|--------|---|---------------------|---------------|



Connessione / Connected: 960349

| Emmerre | Adattabile a / Adaptable to | Dettagli / Detail | Applicazioni / Applications |
|---|---------------------------------|---|-----------------------------|
| 960578 | MBR5185 | <ul style="list-style-type: none"> - Esterno/External Ø mm. 375 - Interno/Internal Ø mm. 117 - Altezza fascia/Height band mm. 108 - Spessore/Thickness mm. 45 <li style="padding-left: 20px;">- 10 Fori/Holes - Senza ABS/without ABS <p>- Fascia autoventilata/Self-Ventilated Band - Omologazione E11/Homologation E11: E11 90R - 02C01047/21144</p> | Ror Axle |
|  960224 | 3218N1340 | <ul style="list-style-type: none"> - Esterno/External Ø mm. 436 - Interno/Internal Ø mm. 210 - Altezza fascia/Height band mm. 138,50 - Spessore/Thickness mm. 45 <li style="padding-left: 20px;">- 10 Fori/Holes - Fascia autoventilata/Self-Ventilated Band <p>- Omologazione E11/Homologation E11: E11 90R - 02C01047/19596 E11 90R - 02C01165/24552</p> | Ror Axle |
|  960579 | MBR9020 | <ul style="list-style-type: none"> - Esterno/External Ø mm. 434 - Interno/Internal Ø mm. 194 - Altezza fascia/Height band mm. 109 - Spessore/Thickness mm. 45 <li style="padding-left: 20px;">- 10 Fori/Holes - Fascia autoventilata/Self-Ventilated Band <p>- Omologazione E11/Homologation E11: E11 90R - 02C01047/26550</p> | Ror Axle |
|  960581 | MBR9016 68323736 98325977 | <ul style="list-style-type: none"> - Esterno/External Ø mm. 434 - Interno/Internal Ø mm. 194 - Altezza fascia/Height band mm. 135 - Spessore/Thickness mm. 45 <li style="padding-left: 20px;">- 10 Fori/Holes - Fascia autoventilata/Self-Ventilated Band | Ror Axle |

DISCHI FRENO
BRAKE DISCS
DISQUES DE FREIN
BREMSSCHEIBEN
ТОРМОЗНЫЕ ДИСКИ
DISCOS DE FRENOS

EMMERRE
spare parts for trucks and trailers

Dischi Freno
Brake Discs

SAF

| Applicazioni / Applications | Dettagli / Detail | Adattabile a / Adaptable to | Emmerre |
|---|--|--|---------------|
| Saf Axle Trailer SKRB SKRLB - SKRS SKRZ - SK | Esterno/External Ø mm. 377 - Interno/Internal Ø mm. 244 - Altezza fascia/Height band mm. 157,50 - Spessore/Thickness mm. 45 - 8 Fori/Holes - Ruote da/Wheels from 19.5" - Fascia autoventilata/Self-Ventilated Band - Omologazione E11/Homologation E11: E11 90R - 02C01047/21144 E11 90R - 02C01165/30217 | 4079000400 | 960298 |
| Connessione / Connected:  960948E3-960999E3  960523 | | | |
| Saf Axle Trailer SKRZ SK - SKRB SKRLB - SKRS | - Esterno/External Ø mm. 375,50 - Interno/Internal Ø mm. 131 - Altezza fascia/Height band mm. 139,50 - Spessore/Thickness mm. 45 - 12 Fori/Holes - Ruote da/Wheels from 19.5" - Fascia autoventilata/Self-Ventilated Band - Omologazione E11/Homologation E11: E11 90R - 02C01047/21144 E11 90R - 02C01165/30217 | 4079000701 4079000700 | 960371 |
| Connessione / Connected:  960948E3-960999E3 | | | |
| Saf Axle Trailer SK SKRZ - SKRB SKRS | - Esterno/External Ø mm. 430 - Interno/Internal Ø mm. 276 - Altezza fascia/Height band mm. 160,50 - Spessore/Thickness mm. 45 - 10 Fori/Holes - Ruote da/Wheels from 22.5" - Fascia autoventilata/Self-Ventilated Band - Omologazione E11/Homologation E11: E11 90R - 02C01047/19596 E11 90R - 02C01165/24552 | 4079000300 4079000301 | 960353 |
| Connessione / Connected:  960944E1-960944E3-960949E3  960523-960524 | | | |
| Saf Axle Trailer SK SKRB | - Esterno/External Ø mm. 430 - Interno/Internal Ø mm. 131 - Altezza fascia/Height band mm. 130 - Spessore/Thickness mm. 45 - 12 Fori/Holes - Ruote da/Wheels from 22.5" - Con sede lavorata/With machined housing - Fascia autoventilata/Self-Ventilated Band - E11 90R - 02C01047/19596 E11 90R - 02C01165/24552 | 4079000502 4079000501 4079000500 | 960362 |
| Connessione / Connected:  960944E1-960944E3-960949E3  960523-960524 | | | |

I riferimenti indicati non sono originali ma perfettamente intercambiabili. I codici originali e le case costruttrici sono indicati a puro titolo informativo
The details described are not original but perfectly interchangeable. The original references and manufacturer names are given for information purposes only.

| Emmerre | Adattabile a / Adaptable to | Dettagli / Detail | Applicazioni / Applications |
|---------------|---|--|-------------------------------------|
| 960468 | 4079001500 3079001500 | <ul style="list-style-type: none"> - Esterno/External Ø mm. 430 - Interno/Internal Ø mm. 164 - Altezza fascia/Height band mm. 135 - Spessore/Thickness mm. 45 <li style="padding-left: 20px;">- 10 Fori/Holes - Ruote da/Wheels from 19.5" <li style="padding-left: 20px;">- Con ABS/With ABS - Fascia autoventilata/Self-Ventilated Band | SI11-22K01 SI9-22W ZI9-22 K01 |
| | | Connessione / Connected:  960891-960102E3 | |
| 960469 | 4079001701 | <ul style="list-style-type: none"> - Esterno/External Ø mm. 430 - Interno/Internal Ø mm. 189,20 - Altezza fascia/Height band mm. 131 - Spessore/Thickness mm. 45 <li style="padding-left: 20px;">- 10 Fori/Holes - Fascia autoventilata/Self-Ventilated Band - Omologazione E11/Homologation E11: E11 90R - 02C01047/19596 | B9-22K01 B9-22W |
| | | Connessione / Connected:  960102E3-960891 | |
| 960395 | 4079001001 4079001000 4079001003 4079001004 4079001002 MBR5139 | <ul style="list-style-type: none"> - Esterno/External Ø mm. 376 - Interno/Internal Ø mm. 164 - Altezza fascia/Height band mm. 57,50 - Spessore/Thickness mm. 45 <li style="padding-left: 20px;">- 10 Fori/Holes - Ruote da/Wheels from 19.5" - Fascia autoventilata/Self-Ventilated Band - Omologazione E11/Homologation E11: E11 90R - 02C01165/30218 E11 90R - 02C01047/33950 | Saf Axle SN6 SKRB |
| | | Connessione / Connected:  960102E3-960891-960794E3 | |
| 960396 | 4079001300 4079001301 4079001302 4079001303 MBR5125 | <ul style="list-style-type: none"> - Esterno/External Ø mm. 430 - Interno/Internal Ø mm. 164 - Altezza fascia/Height band mm. 48 - Spessore/Thickness mm. 45 <li style="padding-left: 20px;">- 10 Fori/Holes - Ruote da/Wheels from 22.5" - Fascia autoventilata/Self-Ventilated Band - Omologazione E11/Homologation E11: E11 90R - 02C01165/27060 E11 90R - 02C01047/26548 | Saf Axle SN7 SKRB |
| | | Connessione / Connected:  960102E3-960891-960794E3 | |

EMMERRE
MODIFICATION

EMMERRE
MODIFICATION

DISCHI FRENO
BRAKE DISCS
DISQUES DE FREIN
BREMSSCHEIBEN
ТОРМОЗНЫЕ ДИСКИ
DISCOS DE FRENOS

EMMERRE
spare parts for trucks and trailers

SAF

| Applicazioni / Applications | Dettagli / Detail | Adattabile a / Adaptable to | Emmerre |
|---|---|-----------------------------|---------------|
| B9-19K B9-19W | <ul style="list-style-type: none"> - Assale anteriore/ Front Axle - Esterno/External Ø mm. 377 - Interno/Internal Ø mm. 215 - Altezza fascia/Height band mm. 141 - Spessore/Thickness mm. 45 - 10 Fori/Holes - Fascia autoventilata/Self-Ventilated Band - Omologazione E11/Homologation E11: E11 90R - 02C01047/21144 | 4079001801 4079001800 | 960467 |
| Connessione / Connected:  960999E3 | | | |
| SI 11-19K SI 9-19K SI 9-19W ZI 11-19K ZI 9-19K | <ul style="list-style-type: none"> - Assale anteriore/ Front Axle - Esterno/External Ø mm. 376 - Interno/Internal Ø mm. 193 - Altezza fascia/Height band mm. 145 - Spessore/Thickness mm. 45 - 10 Fori/Holes - Fascia autoventilata/Self-Ventilated Band - Con ABS/With ABS | 3079001601 3079001600 | 960484 |
| Saf AXLE | <ul style="list-style-type: none"> - Esterno/External Ø mm. 377 - Interno/Internal Ø mm. 232 - Altezza fascia/Height band mm. 157,50 - Spessore/Thickness mm. 45 - 8 Fori/Holes - Fascia autoventilata/Self-Ventilated Band - Omologazione E11/Homologation E11: E11 90R - 02C01047/21144 | 4079001400 | 960128 |



| Emmerre | Adattabile a / Adaptable to | Dettagli / Detail | Applicazioni / Applications |
|---|-----------------------------|--|-----------------------------|
| 960052 | 1402272 | <ul style="list-style-type: none"> - Assale anteriore e posteriore <i>Front and Rear Axle</i> - Esterno/External Ø mm. 429,50 - Interno/Internal Ø mm. 208 - Altezza fascia/Height band mm. 131 - Spessore/Thickness mm. 45 - 10 Fori/Holes - Fascia autoventilata/Self-Ventilated Band - Omologazione E11/Homologation E11: E11 90R - 02C01047/26551 | 94 |
| | 1852817 | | 114 |
|  | 1386686 | | 124 |
| | 1367735 | | 144 |
| Connessione / Connected:  960944E1-960944E3-960891 | | | |
| 960693 | 1415147 | <ul style="list-style-type: none"> - Assale anteriore e posteriore <i>Front and Rear Axle</i> - Esterno/External Ø mm. 430 - Interno/Internal Ø mm. 203 - Altezza fascia/Height band mm. 131 - Spessore/Thickness mm. 45 - 10 Fori/Holes - Fascia autoventilata/Self-Ventilated Band - Omologazione E11/Homologation E11: E11 90R - 02C01047/19596 | Serie 4 Autobus |
| | | | Serie F-K-N |
|  | | | Autobus |
| | | | |
| Connessione / Connected:  960944E1-960944E3  960914 | | | |

DISCHI FRENO
BRAKE DISCS
DISQUES DE FREIN
BREMSSCHEIBEN
ТОРМОЗНЫЕ ДИСКИ
DISCOS DE FRENOS

EMMERRE
spare parts for trucks and trailers

SCHMITZ





| Applicazioni / Applications | Dettagli / Detail | Adattabile a / Adaptable to | Emmerre |
|---|---|-----------------------------|---------------|
| Trailer Cargo Bull Schmitz SC Rotos | <ul style="list-style-type: none"> - Esterno/External Ø mm. 430 - Interno/Internal Ø mm. 290 - Altezza fascia/Height band mm. 168,50 - Spessore/Thickness mm. 45 - 10 Fori/Holes - Fascia autoventilata/Self-Ventilated Band - Omologazione E11/Homologation E11: E11 90R - 02C01047/19596 E11 90R - 02C01165/24552 | 017870 0520010006 | 960018 |



Connessione / Connected:  960944E1-960944E3-960891

| | | | |
|--------------------|---|---------|---------------|
| Trailer Cargo Bull | <ul style="list-style-type: none"> - Esterno/External Ø mm. 375 - Interno/Internal Ø mm. 335 - Altezza fascia/Height band mm. 168,50 - Spessore/Thickness mm. 45 - 10 Fori/Holes - Fascia autoventilata/Self-Ventilated Band - Omologazione E11/Homologation E11: E11 90R - 02C01047/21144 | 1088133 | 960031 |
|--------------------|---|---------|---------------|



| Emmerre | Adattabile a / Adaptable to | Dettagli / Detail | Applicazioni / Applications |
|---|---|--|-----------------------------|
| 960364 | 449418 M078157 103836 | <ul style="list-style-type: none"> - Esterno/External Ø mm. 377 - Interno/Internal Ø mm. 169 - Altezza fascia/Height band mm. 139 - Spessore/Thickness mm. 45 <li style="padding-left: 20px;">- 8 Fori/Holes - Con ABS/With ABS - Fascia autoventilata/Self-Ventilated Band - Omologazione E11/Homologation E11: E11 90R - 02C01047/21144 E11 90R - 02C01165/30217 | Trailer SMB 9 TON |
| Connessione / Connected:  960948E3  960523 | | | |
| 960363 | 449445 M069018 M200135 MBR5064 | <ul style="list-style-type: none"> - Esterno/External Ø mm. 430 - Interno/Internal Ø mm. 280 - Altezza fascia/Height band mm. 155 - Spessore/Thickness mm. 45 <li style="padding-left: 20px;">- 10 Fori/Holes - Con ABS/With ABS - Fascia autoventilata/Self-Ventilated Band - Omologazione E11/Homologation E11: E11 90R - 02C01047/19596 E11 90R - 02C01165/24552 | Trailer SMB 9 TON |
| Connessione / Connected:  960944E1-960944E3  960523 | | | |

DISCHI FRENO
BRAKE DISCS
DISQUES DE FREIN
BREMSSCHEIBEN
ТОРМОЗНЫЕ ДИСКИ
DISCOS DE FRENOS

EMMERRE
spare parts for trucks and trailers

VOLVO

| Applicazioni / Applications | Dettagli / Detail | Adattabile a / Adaptable to | Emmerre |
|-----------------------------|---|--------------------------------|---------------|
| FL 4 FL 6 | <ul style="list-style-type: none"> - Assale anteriore e posteriore Front and Rear Axle - Esterno/External Ø mm. 322 - Interno/Internal Ø mm. 132 - Altezza fascia/Height band mm. 90 - Spessore/Thickness mm. 30 - 6 Fori/Holes - Fascia autoventilata/Self-Ventilated Band - Omologazione E11/Homologation E11: E11 90R - 02C01047/33949 | 6779208 6779205 67792085 | 960310 |



Connessione / Connected:  960927E3

| | | | |
|------|--|--------------------------------|---------------|
| FL 4 | <ul style="list-style-type: none"> - Assale posteriore/Rear Axle - Esterno/External Ø mm. 322 - Interno/Internal Ø mm. 164 - Altezza fascia/Height band mm. 115 - Spessore/Thickness mm. 30 - 6 Fori/Holes - Fascia autoventilata/Self-Ventilated Band | 6779209 6779203 67792093 | 960312 |
|------|--|--------------------------------|---------------|



Connessione / Connected:  960963E3

| | | | |
|------|--|--------------------------------|---------------|
| FL 6 | <ul style="list-style-type: none"> - Assale anteriore/Front Axle - Esterno/External Ø mm. 322 - Interno/Internal Ø mm. 132 - Altezza fascia/Height band mm. 90 - Spessore/Thickness mm. 30 - 8 Fori/Holes - Fascia autoventilata/Self-Ventilated Band - Omologazione E11/Homologation E11: E11 90R - 02C01047/33949 | 6774686 6774687 67746867 | 960311 |
|------|--|--------------------------------|---------------|



Connessione / Connected:  960927E3-960963E3

| | | | |
|------|---|---------|---------------|
| FL 6 | <ul style="list-style-type: none"> - Assale anteriore/Front Axle - Esterno/External Ø mm. 336,50 - Interno/Internal Ø mm. 91,50 - Altezza fascia/Height band mm. 100 - Spessore/Thickness mm. 30 - 10 Fori/Holes - Fascia piena/Full band | 3095652 | 960417 |
|------|---|---------|---------------|



Connessione / Connected:  960430

EMMERRE

spare parts for trucks and trailers

VOLVO

DISCHI FRENO
BRAKE DISCS
DISQUES DE FREIN
BREMSSCHEIBEN
ТОРМОЗНЫЕ ДИСКИ
DISCOS DE FRENOS

| Emmerre | Adattabile a / Adaptable to | Dettagli / Detail | Applicazioni / Applications |
|--|-------------------------------|---|-----------------------------|
| 960387  | 6775227 6775229 6775229 | <ul style="list-style-type: none">- Assale posteriore/Rear Axle- Esterno/External Ø mm. 322- Interno/Internal Ø mm. 216- Altezza fascia/Height band mm. 138- Spessore/Thickness mm. 30<ul style="list-style-type: none">- 8 Fori/Holes- Fascia autoventilata/Self-Ventilated Band- Omologazione E11/Homologation E11: E11 90R - 02C01047/33949 | FL 6 |
| Connessione / Connected:  960927E3-960963E3 | | | |
| 960474  | 3095653 | <ul style="list-style-type: none">- Assale posteriore/Rear Axle- Esterno/External Ø mm. 336- Interno/Internal Ø mm. 215- Altezza fascia/Height band mm. 139- Spessore/Thickness mm. 30<ul style="list-style-type: none">- 8 Fori/Holes- Fascia piena/Full band | FL 6 |
| Connessione / Connected:  960347 | | | |
| 960407  | 3095673 | <ul style="list-style-type: none">- Assale posteriore/Rear Axle- Esterno/External Ø mm. 375- Interno/Internal Ø mm. 225- Altezza fascia/Height band mm. 157- Spessore/Thickness mm. 45<ul style="list-style-type: none">- 8 Fori/Holes- Con ABS/With ABS- Fascia piena/Full band | FL 6 |
| Connessione / Connected:  960430  960525 | | | |
| 960683  | 3095672 68323232 | <ul style="list-style-type: none">- Assale anteriore/Front Axle- Esterno/External Ø mm. 375- Interno/Internal Ø mm. 105,60- Altezza fascia/Height band mm. 116- Spessore/Thickness mm. 45<ul style="list-style-type: none">- 14 Fori/Holes- Fascia piena/Full band | FL 6 |
| Connessione / Connected:  960347 | | | |

DISCHI FRENO
BRAKE DISCS
DISQUES DE FREIN
BREMSSCHEIBEN
ТОРМОЗНЫЕ ДИСКИ
DISCOS DE FRENOS

EMMERRE
spare parts for trucks and trailers

VOLVO

| Applicazioni / Applications | Dettagli / Detail | Adattabile a / Adaptable to | Emmerre |
|---|--|-----------------------------|---------------|
| FL 240 -12-15-16 280 -12-15-16-18 | <ul style="list-style-type: none"> - Assale posteriore/Rear Axle - Esterno/External Ø mm. 375 - Interno/Internal Ø mm. 222 - Altezza fascia/Height band mm. 166,50 - Spessore/Thickness mm. 45 - 8 Fori/Holes - Fascia autoventilata/Self-Ventilated Band - Omologazione E11/Homologation E11: E11 90R - 02C01165/33910 | 20704423 | 960240 |



Connessione / Connected: 960271-960823

| | | | |
|---|---|----------|---------------|
| FL 240 -12-15-16 280 -12-15-16-18 | <ul style="list-style-type: none"> - Assale posteriore/Rear Axle - Esterno/External Ø mm. 375 - Interno/Internal Ø mm. 262 - Altezza fascia/Height band mm. 166,50 - Spessore/Thickness mm. 45 - 10 Fori/Holes - Fascia autoventilata/Self-Ventilated Band - Omologazione E11/Homologation E11: E11 90R - 02C01047/21144 | 20704422 | 960482 |
|---|---|----------|---------------|



Connessione / Connected: 960271-960823

| | | | |
|---|--|----------|---------------|
| FL 240 -12-15-16 280 -12-15-16-18 | <ul style="list-style-type: none"> - Assale anteriore/Front Axle - Esterno/External Ø mm. 375 - Interno/Internal Ø mm. 142 - Altezza fascia/Height band mm. 119 - Spessore/Thickness mm. 45 - 10 Fori/Holes - Fascia autoventilata/Self-Ventilated Band - Omologazione E11/Homologation E11: E11 90R - 02C01047/21144 | 20700509 | 960481 |
|---|--|----------|---------------|



Connessione / Connected: 960823

| | | | |
|---|---|----------------------|---------------|
| FL 240 -12-15-16 280 -12-15-16-18 | <ul style="list-style-type: none"> - Assale anteriore/Front Axle - Esterno/External Ø mm. 410 - Interno/Internal Ø mm. 131 - Altezza fascia/Height band mm. 93 - Spessore/Thickness mm. 45 - 10 Fori/Holes - Fascia autoventilata/Self-Ventilated Band - Omologazione E11/Homologation E11: E11 90R - 02C01047/26553 | 20700508 20931249 | 960193 |
|---|---|----------------------|---------------|



Connessione / Connected: 960271

EMMERRE

spare parts for trucks and trailers

VOLVO

DISCHI FRENO
BRAKE DISCS
DISQUES DE FREIN
BREMSSCHEIBEN
ТОРМОЗНЫЕ ДИСКИ
DISCOS DE FRENOS

| Emmerre | Adattabile a / Adaptable to | Dettagli / Detail | Applicazioni / Applications |
|---|-----------------------------|---|---|
| 960475  | 20763234 | <ul style="list-style-type: none">- Assale posteriore/Rear Axle- Esterno/External Ø mm. 410- Interno/Internal Ø mm. 262- Altezza fascia/Height band mm. 166,50- Spessore/Thickness mm. 45<ul style="list-style-type: none">- 10 Fori/Holes- Fascia autoventilata/Self-Ventilated Band- Omologazione E11/Homologation E11: E11 90R - 02C01047/26554 | FL 240 -12-15-16 280 -12-15-16-18 |
| Connessione / Connected:  960271 | | | |
| 960129  | 20564467 20995144 | <ul style="list-style-type: none">- Assale posteriore/Rear Axle- Esterno/External Ø mm. 434- Interno/Internal Ø mm. 235- Altezza fascia/Height band mm. 130- Spessore/Thickness mm. 45<ul style="list-style-type: none">- 10 Fori/Holes- Fascia autoventilata/Self-Ventilated Band- Omologazione E11/Homologation E11: E11 90R - 02C01047/19596 | B 9/12 |
| Connessione / Connected:  960984E3 | | | |
| 960424   | 85103805 85110494 | <ul style="list-style-type: none">- Esterno/External Ø mm. 375- Interno/Internal Ø mm. 181- Altezza fascia/Height band mm. 45- Spessore/Thickness mm. 45<ul style="list-style-type: none">- 18 Denti/Teeth- Secondo Assale Sterzante Second steering axle- Fascia autoventilata/Self-Ventilated Band- Omologazione E11/Homologation E11: E11 90R - 02C01047/33950 | FM 9 FM 12 FH 12 FH 16 |
| Connessione / Connected:  960347 | | | |
| 960444   | 85103809 | <ul style="list-style-type: none">- Esterno/External Ø mm. 375- Interno/Internal Ø mm. 181- Altezza fascia/Height band mm. 45- Spessore/Thickness mm. 45<ul style="list-style-type: none">- 18 Denti/Teeth- Secondo Assale Sterzante Second steering axle- Fascia piena/Full band | FM 9 FM 12 FH 12 FH 16 |
| Connessione / Connected:  960347 | | | |

DISCHI FRENO
BRAKE DISCS
DISQUES DE FREIN
BREMSSCHEIBEN
ТОРМОЗНЫЕ ДИСКИ
DISCOS DE FRENOS

EMMERRE
spare parts for trucks and trailers

VOLVO

| Applicazioni / Applications | Dettagli / Detail | Adattabile a / Adaptable to | Emmerre |
|---|---|-----------------------------|---------------|
| FM 12/16 FM 9/12 | <ul style="list-style-type: none"> - Assale anteriore e posteriore Front and Rear Axle - Esterno/External Ø mm. 410 - Interno/Internal Ø mm. 220 - Altezza fascia/Height band mm. 45 - Spessore/Thickness mm. 45 - 24 Denti/Teeth - Fascia autoventilata/Self-Ventilated Band - Omologazione E11/Homologation E11: E11 90R - 02G01047/26555 | 85110495 85103804 | 960218 |
| Connessione / Connected:  960271-960349-970006E3-960394E3 | | | |
| FM 9/12 FH 12/16 | <ul style="list-style-type: none"> - Assale anteriore e posteriore/Front and Rear Axle - Esterno/External Ø mm. 410 - Interno/Internal Ø mm. 220 - Altezza fascia/Height band mm. 45 - Spessore/Thickness mm. 45 - 8 Fori/Holes - 24 Denti/Teeth - Fascia autoventilata/Self-Ventilated Band - Ns. modifica con flangia di fissaggio Our modification with fixing flange - Ns. Brevetto/Our patent | 85110495 85103804 | 960463 |
| Connessione / Connected:  960218  960271-960349-970006E3-960394E3 | | | |
| FH 12/16 FM 9/12 FM FH | <ul style="list-style-type: none"> - Assale anteriore e posteriore Front and Rear Axle - Esterno/External Ø mm. 410 - Interno/Internal Ø mm. 220 - Altezza fascia/Height band mm. 45 - Spessore/Thickness mm. 45 - 24 Denti/Teeth - Fascia piena/Full band | 85103806 | 960486 |
| Connessione / Connected:  960271-960349-970006E3-960394E3 | | | |



EMMERRE
MODIFICATION



PATENT
PENDING

EMMERRE
MODIFICATION



EMMERRE
MODIFICATION

EMMERRE

spare parts for trucks and trailers

VOLVO

DISCHI FRENO
BRAKE DISCS
DISQUES DE FREIN
BREMSSCHEIBEN
ТОРМОЗНЫЕ ДИСКИ
DISCOS DE FRENOS

| Emmerre | Adattabile a / Adaptable to | Dettagli / Detail | Applicazioni / Applications |
|--|--|--|------------------------------|
| 960370  EMMERRE MODIFICATION | 21575071 85103803 85110496 20995144 | - Assale anteriore e posteriore <i>Front and Rear Axle</i> - Esterno/External Ø mm. 434 - Interno/Internal Ø mm. 220 - Altezza fascia/Height band mm. 45 - Spessore/Thickness mm. 45 - 24 Denti/Teeth - Fascia autoventilata/Self-Ventilated Band - Omologazione E11/Homologation E11: E11 90R - 02C01047/26548 | FH 12 FH 16 FL 6 FM |
| Connessione / Connected:  960993E3-960349-970006E3 | | | |
| 960456  EMMERRE MODIFICATION PATENT PENDING | 21575071 85103803 85110496 | - Assale anteriore e posteriore <i>Front and Rear Axle</i> - Esterno/External Ø mm. 434 - Interno/Internal Ø mm. 220 - Altezza fascia/Height band mm. 45 - Spessore/Thickness mm. 45 - 24 Denti/Teeth - Fascia piena/Full band - Ns. modifica con flangia di fissaggio <i>Our modification with fixing flange</i> - Ns. Brevetto / our Patent | FL 6 FM FH 12/16 |
| Connessione / Connected:  960370  960993E3-960349-970006E3 | | | |
| 960374  EMMERRE MODIFICATION | 3092710 | - Assale anteriore e posteriore <i>Front and Rear Axle</i> - Esterno/External Ø mm. 434 - Interno/Internal Ø mm. 220 - Altezza fascia/Height band mm. 45 - Spessore/Thickness mm. 45 - 24 Denti/Teeth - Fascia piena/Full band - Omologazione E11/Homologation E11: E11 90R - 02C01047/26549 | FH 12 FH 16 FL 6 FM |
| Connessione / Connected:  960993E3-960349-970006E3 | | | |
| 960457  EMMERRE MODIFICATION PATENT PENDING | 3092710 | - Assale anteriore e posteriore <i>Front and Rear Axle</i> - Esterno/External Ø mm. 434 - Interno/Internal Ø mm. 220 - Altezza fascia/Height band mm. 45 - Spessore/Thickness mm. 45 - 8 Fori/Holes - 24 Denti/Teeth - Fascia piena/Full band - Ns. modifica con flangia di fissaggio <i>Our modification with fixing flange</i> - Ns. Brevetto/Our Patent | FL 6 FM FH 12/16 |
| Connessione / Connected:  960374  960993E3-960349-970006E3 | | | |

DISCHI FRENO
BRAKE DISCS
DISQUES DE FREIN
BREMSSCHEIBEN
ТОРМОЗНЫЕ ДИСКИ
DISCOS DE FRENOS

EMMERRE
spare parts for trucks and trailers

VOLVO

| Applicazioni / Applications | Dettagli / Detail | Adattabile a / Adaptable to | Emmerre |
|-----------------------------|---|-----------------------------|---------------|
| FH / FL / FM | - Kit fissaggio disco freno/ Brake disc fixing kit | 3092224 | 960608 |



| | | | |
|--|---|----------|---------------|
| Connessione / Connected:  960218-960486-960370-960374 | | | |
| FE / FH / FM FMX | - Kit fissaggio disco freno/ Brake disc fixing kit | 85103814 | 960609 |



| | | | |
|--|--|--|--|
| Connessione / Connected:  960424-960444 | | | |
|--|--|--|--|

Emmerre

Adattabile a / *Adaptable to*

Dettagli / *Detail*

Applicazioni / *Applications*



TAMBURI FRENO

BRAKE DRUMS
TAMBOURS DE FREIN
BREMSTROMMELN
ТОРМОЗНЫЕ БАРАБАНЫ
TAMBORES DE FRENO

NEWS

| Emmerre | Descrizione/Description | Adattabile/Adaptable to | Pagina/Page |
|---------------|---------------------------|-------------------------|-------------|
| 932748 | TAMBURO FRENO /BRAKE DRUM | CALABRESE | 90 |
| 932954 | TAMBURO FRENO /BRAKE DRUM | SAF | 113 |
| 932615 | TAMBURO FRENO /BRAKE DRUM | VOLVO | 122 |



**TAMBURI FRENO
BRAKE DRUMS
TAMBOURS DE FREIN
BREMSTROMMELN
ТОРМОЗНЫЕ БАРАБАНЫ
TAMBORES DE FRENO**

EMMERRE
spare parts for trucks and trailers

BPW

| Applicazioni / Applications | Dettagli / Detail | Adattabile a / Adaptable to | Emmerre |
|---|--|--|---------------|
| Series H Series R 8 Ton Viberti | - Con mozzo/With Hub - Interno/Internal Ø: 420 mm - Altezza fascia/High band: 190 mm - Altezza totale/Total Height: 250 mm - Diametro mozzo/Bore hub: 290 mm - Interasse tra fori/Wheelbase between holes: 335 mm - Fori/Holes: 10 - Fori/Holes Ø: 23 mm | 0310967740 0310667540 | 932800 |
| Series H Series R 9 Ton Viberti | - Con mozzo/With Hub - Interno/Internal Ø: 420 mm - Altezza fascia/High band: 191 mm - Altezza totale/Total Height: 226 mm - Diametro mozzo/Bore hub: 290 mm - Interasse tra fori/Wheelbase between holes: 335 mm - Fori/Holes: 10 - Fori/Holes Ø: 23 mm | 0310667620 0310967130 0310967820 | 932801 |
| 8-9 Ton Viberti | - Con mozzo/With Hub - Interno/Internal Ø: 420 mm - Altezza fascia/High band: 193 mm - Altezza totale/Total Height: 246,50 mm - Diametro mozzo/Bore hub: 290 mm - Interasse tra fori/Wheelbase between holes: 335 mm - Fori/Holes: 10 - Fori/Holes Ø: 23 mm | 0310667120 0310667360 0310667400 0310667430 | 932802 |
| Eco Maxx Eco Plus 8-9 Ton Viberti Meritor | - Con mozzo/With Hub - Interno/Internal Ø: 420 mm - Altezza fascia/High band: 191 mm - Altezza totale/Total Height: 226 mm - Diametro mozzo/Bore hub: 290 mm - Interasse tra fori/Wheelbase between holes: 335 mm - Fori/Holes: 10 - Fori/Holes Ø: 23 mm | 0310967190 MBD1053 0310967790 | 932803 |



| Emmerre | Adattabile a / Adaptable to | Dettagli / Detail | Applicazioni / Applications |
|--|--|---|--|
| 932804  | 0310590020 0310990220 | <ul style="list-style-type: none"> - Interno/Internal Ø: 360 mm - Altezza fascia/High band: 208 mm - Altezza totale/Total Height: 262 mm - Diametro mozzo/Bore hub: 230 mm - Interasse tra fori/Wheelbase between holes: 275 mm - Fori/Holes: 8 - Fori/Holes Ø: 23 mm | Series KH/KR 9-10-12 Ton |
| 932805  | 0310946490 0310546290 | <ul style="list-style-type: none"> - Interno/Internal Ø: 300 mm - Altezza fascia/High band: 211 mm - Altezza totale/Total Height: 260 mm - Diametro mozzo/Bore hub: 190 mm - Interasse tra fori/Wheelbase between holes: 225 mm - Fori/Holes: 10 - Fori/Holes Ø: 23 mm | Series NH/NR 10-12 Ton Viberti |
| 932806  | 0310977720 0310677520 0310977440 | <ul style="list-style-type: none"> - Con mozzo/With Hub - Interno/Internal Ø: 420 mm - Altezza fascia/High band: 219 mm - Altezza totale/Total Height: 287 mm - Diametro mozzo/Bore hub: 290 mm - Interasse tra fori/Wheelbase between holes: 335 mm - Fori/Holes: 10 - Fori/Holes Ø: 23 mm | Series H/R 12 Ton Viberti |
| 932807  | 0310946400 0310546200 | <ul style="list-style-type: none"> - Interno/Internal Ø: 300 mm - Altezza fascia/High band: 218 mm - Altezza totale/Total Height: 295 mm - Diametro mozzo/Bore hub: 190 mm - Interasse tra fori/Wheelbase between holes: 225 mm - Fori/Holes: 10 - Fori/Holes Ø: 23 mm | Series NH/NR 10-12 Ton Viberti Axle 15" |

**TAMBURI FRENO
BRAKE DRUMS
TAMBOURS DE FREIN
BREMSTROMMELN
ТОРМОЗНЫЕ БАРАБАНЫ
TAMBORES DE FRENO**

EMMERRE
spare parts for trucks and trailers

BPW

| Applicazioni / Applications | Dettagli / Detail | Adattabile a / Adaptable to | Emmerre |
|--|--|---|--|
| Series H/R 12 Ton Viberti | <ul style="list-style-type: none"> - Con mozzo/With Hub - Interno/Internal Ø: 420 mm - Altezza fascia/High band: 213 mm - Altezza totale/Total Hight: 259 mm - Diametro mozzo/Bore hub: 290 mm - Interasse tra fori/Wheelbase between holes: 335 mm - Fori/Holes: 10 - Fori/Holes Ø: 23 mm | 0310977160 0310677570 0310977770 MBD1019 | 932808  |
| Series KH/KR Axle 19" 1/2 10-12 Ton Viberti | <ul style="list-style-type: none"> - Con mozzo/With Hub - Interno/Internal Ø: 360 mm - Altezza fascia/High band: 209 mm - Altezza totale/Total Hight: 262 mm - Diametro mozzo/Bore hub: 190 mm - Interasse tra fori/Wheelbase between holes: 225 mm - Fori/Holes: 10 - Fori/Holes Ø: 23 mm | 0310990240 0310590040 | 932809  |
| Axle 15" 10-12 Ton NA - NH - NR - NRS - NRZ | <ul style="list-style-type: none"> - Interno/Internal Ø: 300 mm - Altezza fascia/High band: 213 mm - Altezza totale/Total Hight: 260 mm - Diametro mozzo/Bore hub: 190 mm - Interasse tra fori/Wheelbase between holes: 225 mm - Fori/Holes: 10 - Fori/Holes Ø: 23 mm | 0310946060 | 932817  |
| Series H/R 11-13 Ton Viberti | <ul style="list-style-type: none"> - Con raggera/With rays - Interno/Internal Ø: 420 mm - Altezza fascia/High band: 210 mm - Altezza totale/Total Hight: 238,50 mm - Diametro mozzo/Bore hub: 290 mm - Interasse tra fori/Wheelbase between holes: 335 mm - Fori/Holes: 6 - Fori/Holes Ø: 20,50 mm | 0310667440 0310667290 | 932810  |

| Emmerre | Adattabile a / Adaptable to | Dettagli / Detail | Applicazioni / Applications |
|--|-------------------------------------|---|--|
| 932811  | 0310677560 | <ul style="list-style-type: none"> - Interno/Internal Ø: 420 mm - Altezza fascia/High band: 202 mm - Altezza totale/Total Height: 247 mm - Diametro mozzo/Bore hub: 290 mm - Interasse tra fori/Wheelbase between holes: 335 mm - Fori/Holes: 6 - Fori/Holes Ø: 21 mm | Series H/R 12-14 Ton Viberti |
| 932816  | 0310977170 0310977420 MBD1054 | <ul style="list-style-type: none"> - Con mozzo/With Hub - Interno/Internal Ø: 420 mm - Altezza fascia/High band: 215 mm - Altezza totale/Total Height: 259 mm - Diametro mozzo/Bore hub: 290 mm - Interasse tra fori/Wheelbase between holes: 335 mm - Fori/Holes: 10 - Fori/Holes Ø: 23 mm | Series H/R 12 Ton Meritor |
| 932815  | 0310967290 | <ul style="list-style-type: none"> - Interno/Internal Ø: 420 mm - Altezza fascia/High band: 185 mm - Altezza totale/Total Height: 222 mm - Diametro mozzo/Bore hub: 290 mm - Interasse tra fori/Wheelbase between holes: 335 mm - Fori/Holes: 10 - Fori/Holes Ø: 23 mm | Eco Maxx Series HSF-HZF 10-12 Ton Meritor |
| 932818  | 0310977180 | <ul style="list-style-type: none"> - Interno/Internal Ø: 420 mm - Altezza fascia/High band: 219 mm - Altezza totale/Total Height: 286 mm - Diametro mozzo/Bore hub: 290 mm - Interasse tra fori/Wheelbase between holes: 335 mm - Fori/Holes: 10 - Fori/Holes Ø: 23 mm | Eco Maxx HSF - HZF Eco Plus H / SH |

**TAMBURI FRENO
BRAKE DRUMS
TAMBOURS DE FREIN
BREMSTROMMELN
ТОРМОЗНЫЕ БАРАБАНЫ
TAMBORES DE FRENO**

EMMERRE
spare parts for trucks and trailers

BPW

| Applicazioni / Applications | Dettagli / Detail | Adattabile a / Adaptable to | Emmerre |
|-----------------------------|---|--|---------------|
| Eco | <ul style="list-style-type: none"> - Interno/Internal Ø: 420 mm - Altezza fascia/High band: 198 mm - Altezza totale/Total Height: 237 mm - Diametro mozzo/Bore hub: 290 mm - Interasse tra fori/Wheelbase between holes: 335 mm - Fori/Holes: 10-2-2 - Fori/Holes Ø: 23-M12-13SV | 0310967760 | 932819 |
| Axle 11 Ton Viberti | <ul style="list-style-type: none"> - Interno/Internal Ø: 420 mm - Altezza fascia/High band: 214 mm - Altezza totale/Total Height: 275 mm - Diametro mozzo/Bore hub: 290 mm - Interasse tra fori/Wheelbase between holes: 335 mm - Fori/Holes: 10 - Fori/Holes Ø: 23 mm | 0310677040 0310677410 0310677190 0310677120 | 932814 |
| | | | |
| | | | |



Tamburi Freno
Brake Drums

| Emmerre | Adattabile a / <i>Adaptable to</i> | Dettagli / <i>Detail</i> | Applicazioni / <i>Applications</i> |
|---------------|------------------------------------|--|------------------------------------|
| 932748 | 117242/A | <ul style="list-style-type: none"> - Interno/<i>Internal</i> Ø: 420 mm - Altezza fascia/<i>High band</i>: 210 mm - Altezza totale/<i>Total Height</i>: 242 mm - Diametro mozzo/<i>Bore hub</i>: 290 mm - Interasse tra fori/<i>Wheelbase between holes</i>: 335 mm <li style="padding-left: 20px;">- Fori/<i>Holes</i>: 6 <li style="padding-left: 20px;">- Fori/<i>Holes</i> Ø: 21,50 mm | Axle |



CARDI

| Emmerre | Adattabile a / <i>Adaptable to</i> | Dettagli / <i>Detail</i> | Applicazioni / <i>Applications</i> |
|---------------|------------------------------------|--|------------------------------------|
| 932750 | 87414502 | <ul style="list-style-type: none"> - Interno/<i>Internal</i> Ø: 420 mm - Altezza fascia/<i>High band</i>: 215 mm - Altezza totale/<i>Total Height</i>: 320 mm - Diametro mozzo/<i>Bore hub</i>: 291 mm - Interasse tra fori/<i>Wheelbase between holes</i>: 335 mm <li style="padding-left: 20px;">- Fori/<i>Holes</i>: 10 <li style="padding-left: 20px;">- Fori/<i>Holes</i> Ø: 26 mm | 103 203 503 573 |
| 932751 | 87414402 | <ul style="list-style-type: none"> - Interno/<i>Internal</i> Ø: 420 mm - Altezza fascia/<i>High band</i>: 185 mm - Altezza totale/<i>Total Height</i>: 264 mm - Diametro mozzo/<i>Bore hub</i>: 291 mm - Interasse tra fori/<i>Wheelbase between holes</i>: 335 mm <li style="padding-left: 20px;">- Fori/<i>Holes</i>: 10 <li style="padding-left: 20px;">- Fori/<i>Holes</i> Ø: 26 mm | 103 203 503 573 |



**TAMBURI FRENO
BRAKE DRUMS
TAMBOURS DE FREIN
BREMSTROMMELN
ТОРМОЗНЫЕ БАРАБАНЫ
TAMBORES DE FRENO**

EMMERRE
spare parts for trucks and trailers

DAF

Tamburi Freno
Brake Drums

| Applicazioni / Applications | Dettagli / Detail | Adattabile a / Adaptable to | Emmerre |
|---|---|------------------------------|---------------|
| CF 65 CF 75 CF 85 XF 95 XF 105 | - Posteriore rinforzato/Rear Reinforced - Interno/Internal Ø: 420 mm - Altezza fascia/High band: 215 mm - Altezza totale/Total Height: 287,30 mm - Diametro mozzo/Bore hub: 285 mm - Interasse tra fori/Wheelbase between holes: 335 mm - Fori/Holes: 10/2/2 - Fori/Holes Ø: 24/30-14/30/M12x1,75 | 0754397 0075983 | 932000 |
| CF 65 CF 75 CF 85 XF 95 | - Anteriore/Front - Interno/Internal Ø: 420 mm - Altezza fascia/High band: 167,50 mm - Altezza totale/Total Height: 227 mm - Diametro mozzo/Bore hub: 285 mm - Interasse tra fori/Wheelbase between holes: 335 mm - Fori/Holes: 10/2/2 - Fori/Holes Ø: 24/30-14/30/M12x1,75 | 1233462 0284620 094903 | 932001 |
| CF 65 CF 75 CF 85 XF 95 | - Posteriore/Rear - Interno/Internal Ø: 420 mm - Altezza fascia/High band: 217 mm - Altezza totale/Total Height: 288 mm - Diametro mozzo/Bore hub: 285 mm - Interasse tra fori/Wheelbase between holes: 335 mm - Fori/Holes: 10/2/2 - Fori/Holes Ø: 24/30-14/30/M12x1,75 | 365579 057983 1523681 | 932004 |
| CF 75 CF 85 F 1900 F 2800 F 3300 F 75 F 85 F 95 XF 95 | - Anteriore/Front - Interno/Internal Ø: 420 mm - Altezza fascia/High band: 187 mm - Altezza totale/Total Height: 239 mm - Diametro mozzo/Bore hub: 285 mm - Interasse tra fori/Wheelbase between holes: 335 mm - Fori/Holes: 10/2/2 - Fori/Holes Ø: 24-14/30/M12x1,75 | 0090500 0386563 | 932006 |



| Emmerre | Adattabile a / Adaptable to | Dettagli / Detail | Applicazioni / Applications |
|---|-----------------------------|---|--|
| 960027 | 7165379 7162112 | <p>- Posteriore/Rear</p> <ul style="list-style-type: none"> - Interno/Internal Ø: 254 mm - Altezza fascia/High band: 96,50 mm - Altezza totale/Total Height: 122,50 mm - Diametro mozzo/Bore hub: 129,80 mm - Interasse tra fori/Wheelbase between holes: 170 mm - Fori/Holes: 6/1 - Fori/Holes Ø: 19 - 8,5SV | Daily Restyling New Daily Turbodaily |
|  | | | |
| 960028 | 7165402 503472816 | <p>- Posteriore/Rear</p> <ul style="list-style-type: none"> - Interno/Internal Ø: 270 mm - Altezza fascia/High band: 90,50 mm - Altezza totale/Total Height: 144 mm - Diametro mozzo/Bore hub: 129,80 mm - Interasse tra fori/Wheelbase between holes: 170 mm - Fori/Holes: 6/1 - Fori/Holes Ø: 19 - 8,5SV | Daily Restyling New Daily Turbodaily |
|  | | | |
| 932128 | 7166026 | <p>- Posteriore/Rear</p> <ul style="list-style-type: none"> - Interno/Internal Ø: 254 mm - Altezza fascia/High band: 75 mm - Altezza totale/Total Height: 173,50 mm - Diametro mozzo/Bore hub: 129,80 mm - Interasse tra fori/Wheelbase between holes: 170 mm - Fori/Holes: 6/1 - Fori/Holes Ø: 19 - 8SV | New Daily Turbodaily |
|  | | | |
| 932124 | 7172788 | <p>- Posteriore/Rear</p> <ul style="list-style-type: none"> - Interno/Internal Ø: 310 mm - Altezza fascia/High band: 108 mm - Altezza totale/Total Height: 139,50 mm - Diametro mozzo/Bore hub: 165 mm - Interasse tra fori/Wheelbase between holes: 205 mm - Fori/Holes: 6/2 - Fori/Holes Ø: 18 - M10x1,50 | Turbodaily |
|  | | | |

**TAMBURI FRENO
BRAKE DRUMS
TAMBOURS DE FREIN
BREMSTROMMELN
ТОРМОЗНЫЕ БАРАБАНЫ
TAMBORES DE FRENO**

EMMERRE
spare parts for trucks and trailers

IVECO

| Applicazioni / Applications | Dettagli / Detail | Adattabile a / Adaptable to | Emmerre |
|-----------------------------|---|-----------------------------|---|
| Leoncino Lupetto Om | <ul style="list-style-type: none"> - Anteriore e Posteriore/ Front and Rear - Interno/ Internal Ø: 325 mm - Altezza fascia/ High band: 92 mm - Altezza totale/ Total Hight: 137 mm - Diametro mozzo/ Bore hub: 161 mm - Interasse tra fori/ Wheelbase between holes: 205 mm - Fori/ Holes: 6/2/2 - Fori/ Holes Ø: 18,5 - M10x1,25 - 8,5 SV | 8546957 8546971 | 932100 |
| | | |  |
| Cerbiatto Lupetto Om | <ul style="list-style-type: none"> - Anteriore e Posteriore/ Front and Rear - Interno/ Internal Ø: 325 mm - Altezza fascia/ High band: 92 mm - Altezza totale/ Total Hight: 113 mm - Diametro mozzo/ Bore hub: 248 mm - Interasse tra fori/ Wheelbase between holes: 270 mm - Fori/ Holes: 8/2/1 - Fori/ Holes Ø: 12,5 - M10x1,25 | 8546995 8546956 | 932101 |
| | | |  |
| Gammazeta Turbozeta | <ul style="list-style-type: none"> - Anteriore e Posteriore/ Front and Rear - Interno/ Internal Ø: 325 mm - Altezza fascia/ High band: 109 mm - Altezza totale/ Total Hight: 135 mm - Diametro mozzo/ Bore hub: 255 mm - Interasse tra fori/ Wheelbase between holes: 280 mm - Fori/ Holes: 6/4 - Fori/ Holes Ø: 13 - M12x1,25 | 7165361 7160035 | 932103 |
| | | |  |
| Gammazeta | <ul style="list-style-type: none"> - Anteriore e Posteriore/ Front and Rear - Interno/ Internal Ø: 325 mm - Altezza fascia/ High band: 88,50 mm - Altezza totale/ Total Hight: 116 mm - Diametro mozzo/ Bore hub: 255 mm - Interasse tra fori/ Wheelbase between holes: 280 mm - Fori/ Holes: 6/4 - Fori/ Holes Ø: 13 - M12x1,25 | 7160033 4707533 | 932104 |
| | | |  |

| Emmerre | Adattabile a / Adaptable to | Dettagli / Detail | Applicazioni / Applications |
|---------------|-----------------------------|---|---|
| 932105 | 7165564 7160113 | <ul style="list-style-type: none"> - Anteriore e Posteriore/ Front and Rear <ul style="list-style-type: none"> - Interno/Internal Ø: 325 mm - Altezza fascia/High band: 128 mm - Altezza totale/Total Height: 159 mm - Diametro mozzo/Bore hub: 255 mm - Interasse tra fori/Wheelbase between holes: 280 mm <ul style="list-style-type: none"> - Fori/Holes: 6/4 - Fori/Holes Ø: 13-M12x1,25 | 79.10F10 79.12 Zeta 79.13F13 Turbozeta |
| 932130 | 4646008 | <ul style="list-style-type: none"> - Anteriore/Front <ul style="list-style-type: none"> - Interno/Internal Ø: 420 mm - Altezza fascia/High band: 140,50 mm - Altezza totale/Total Height: 154 mm - Diametro mozzo/Bore hub: 298 mm - Interasse tra fori/Wheelbase between holes: 350 mm <ul style="list-style-type: none"> - Fori/Holes: 5 - Fori/Holes Ø: 15 mm | 100NC 110NC 130NC |
| 932126 | 4608754 4608753 | <ul style="list-style-type: none"> - Posteriore/Rear <ul style="list-style-type: none"> - Interno/Internal Ø: 420 mm - Altezza fascia/High band: 134 mm - Altezza totale/Total Height: 150 mm - Diametro mozzo/Bore hub: 298 mm - Interasse tra fori/Wheelbase between holes: 350 mm <ul style="list-style-type: none"> - Fori/Holes: 5 - Fori/Holes Ø: 15 mm | 100NC 110NC 130NC |
| 932123 | 7164441 | <ul style="list-style-type: none"> - Anteriore e Posteriore/ Front and Rear <ul style="list-style-type: none"> - Interno/Internal Ø: 325 mm - Altezza fascia/High band: 147 mm - Altezza totale/:194 mm - Diametro mozzo/Bore hub: 228 mm - Interasse tra fori/Wheelbase between holes: 275 mm <ul style="list-style-type: none"> - Fori/Holes: 8/2/2 - Fori/Holes Ø: 21,5-11SV-M10x15 | 95.14 109.14 |

**TAMBURI FRENO
BRAKE DRUMS
TAMBOURS DE FREIN
BREMSTROMMELN
ТОРМОЗНЫЕ БАРАБАНЫ
TAMBORES DE FRENO**

EMMERRE
spare parts for trucks and trailers

IVECO

| Applicazioni / Applications | Dettagli / Detail | Adattabile a / Adaptable to | Emmerre |
|--|--|-----------------------------|---------------|
| 690N/T2 691N/TS 180NC/TS OM180 | - Anteriore/Front - Interno/Internal Ø: 420 mm - Altezza fascia/High band: 101 mm - Altezza totale/Total Height: 130 mm - Diametro mozzo/Bore hub: 255 mm - Interasse tra fori/Wheelbase between holes: 290 mm - Fori/Holes: 6 - Fori/Holes Ø: 20,5 mm | 4701068 841609 | 932122 |
| 160-180NC/NT 691N1 682N3/N4/T3/T4 684N/NP 693N1 697 | - Posteriore/Rear - Interno/Internal Ø: 420 mm - Altezza fascia/High band: 192 mm - Altezza totale/ 221 mm - Diametro mozzo/Bore hub: 298 mm - Interasse tra fori/Wheelbase between holes: 350 mm - Fori/Holes: 6 - Fori/Holes Ø: 17 mm | 7160107 4605214 | 932102 |
| Turbostar 190/240 330/260 170/175 180/165 159 | - Con mozzo/With Hub - Anteriore e Posteriore/Front and Rear - Interno/Internal Ø: 381 mm - Altezza fascia/High band: 186,20 mm - Altezza totale/Total Height: 235,50 mm - Diametro mozzo/Bore hub: 285 mm - Interasse tra fori/Wheelbase between holes: 335 mm - Fori/Holes: 10/2/2 - Fori/Holes Ø: 23-11SV-M12x1,75 | 4711888 2475817 | 932109 |
| Turbostar 159/165 170/175 180/190 220/240 260/330 | - Con raggera/With rays - Anteriore e Posteriore/Front and Rear - Interno/Internal Ø: 381 mm - Altezza fascia/High band: 189 mm - Altezza totale/Total Height: 230 mm - Diametro mozzo/Bore hub: 320 mm - Interasse tra fori/Wheelbase between holes: 350 mm - Fori/Holes: 6 - Fori/Holes Ø: 16,5 mm | 42026052 | 932108 |



EMMERRE

spare parts for trucks and trailers

IVECO

TAMBURI FRENO
BRAKE DRUMS
TAMBOURS DE FREIN
BREMSTROMMELN
ТОРМОЗНЫЕ БАРАБАНЫ
TAMBORES DE FRENO

| Emmerre | Adattabile a / Adaptable to | Dettagli / Detail | Applicazioni / Applications |
|--|-----------------------------|--|--|
| 932107  | 2479853 597516 | - Con mozzo/With Hub - Posteriore/Rear - Interno/Internal Ø: 381 mm - Altezza fascia/High band: 191 mm - Altezza totale/Total Height: 272 mm - Diametro mozzo/Bore hub: 285 mm - Interasse tra fori/Wheelbase between holes: 335 mm - Fori/Holes: 10/2/2 - Fori/Holes Ø: 23 - M12x1,75 - 11SV | Turbostar 159/165 170/175 180/190 220/240 260/330 |
| 932106  | 7163802 | - Anteriore e Posteriore/Front and Rear - Interno/Internal Ø: 381 mm - Altezza fascia/High band: 186 mm - Altezza totale/Total Height: 243 mm - Diametro mozzo/Bore hub: 285 mm - Interasse tra fori/Wheelbase between holes: 335 mm - Fori/Holes: 10/2/2 - Fori/Holes Ø: 23-11SV-M12x1,75 | Turbostar 159.17/20 330.36 |
| 932111  | 7172552 7166307 | - Posteriore/Rear - Interno/Internal Ø: 360 mm - Altezza fascia/High band: 180 mm - Altezza totale/Total Height: 231 mm - Diametro mozzo/Bore hub: 228 mm - Interasse tra fori/Wheelbase between holes: 275 mm - Fori/Holes: 8/2/2/2 - Fori/Holes Ø: 21,5-11SV-M10x1,5-11/30 | Eurocargo Eurocargo Tector 120/130 260 |
| 932133  | 42063017 | - Posteriore/Rear - Interno/Internal Ø: 381 mm - Altezza fascia/High band: 185 mm - Altezza totale/Total Height: 275 mm - Diametro mozzo/Bore hub: 285 mm - Interasse tra fori/Wheelbase between holes: 335 mm - Fori/Holes: 10/2/2 - Fori/Holes Ø: 25 - M12x1,75 | Eurocargo Eurocargo Tector 135/150 |

**TAMBURI FRENO
BRAKE DRUMS
TAMBOURS DE FREIN
BREMSTROMMELN
ТОРМОЗНЫЕ БАРАБАНЫ
TAMBORES DE FRENO**

EMMERRE
spare parts for trucks and trailers

IVECO

Tamburi Freno
Brake Drums

| Applicazioni / Applications | Dettagli / Detail | Adattabile a / Adaptable to | Emmerre |
|---|--|-----------------------------|---------------|
| Eurocargo Eurocargo Tector 150/280 320 | - Anteriore e Posteriore/ Front and Rear - Interno/ Internal Ø: 360 mm - Altezza fascia/ High band: 179 mm - Altezza totale/ Total Height: 250,50 mm - Diametro mozzo/ Bore hub: 228 mm - Interasse tra fori/ Wheelbase between holes: 275 mm - Fori/ Holes: 8/2/2 - Fori/ Holes Ø: 23,5-11/30-M10x1,5 | 7173107 7167613 | 932110 |
| Eurocargo Eurocargo Tector Eurotech 150/170 180 | - Posteriore/ Rear - Interno/ Internal Ø: 381 mm - Altezza fascia/ High band: 187 mm - Altezza totale/ Total Height: 254 mm - Diametro mozzo/ Bore hub: 285 mm - Interasse tra fori/ Wheelbase between holes: 335 mm - Fori/ Holes: 10/2/2 - Fori/ Holes Ø: 23-11/30-M12x1,75 | 7173281 | 932112 |
| Eurotech Eurostar | - Posteriore/ Rear - Interno/ Internal Ø: 410 mm - Altezza fascia/ High band: 209 mm - Altezza totale/ Total Height: 258 mm - Diametro mozzo/ Bore hub: 285 mm - Interasse tra fori/ Wheelbase between holes: 335 mm - Fori/ Holes: 10/2/2 - Fori/ Holes Ø: 23-11/30-M12x1,75 | 7172079 | 932113 |
| Eurotech Eurostar Cursor | - Posteriore/ Rear - Interno/ Internal Ø: 410 mm - Altezza fascia/ High band: 203 mm - Altezza totale/ Total Height: 250 mm - Diametro mozzo/ Bore hub: 285 mm - Interasse tra fori/ Wheelbase between holes: 335 mm - Fori/ Holes: 10/2/2 - Fori/ Holes Ø: 23-11/30-M12x1,75 | 7180996 | 932114 |



EMMERRE

spare parts for trucks and trailers

IVECO

TAMBURI FRENO
BRAKE DRUMS
TAMBOURS DE FREIN
BREMSTROMMELN
ТОРМОЗНЫЕ БАРАБАНЫ
TAMBORES DE FRENO

| Emmerre | Adattabile a / Adaptable to | Dettagli / Detail | Applicazioni / Applications |
|--|-----------------------------|---|---|
| 932116  | 7172329 | <ul style="list-style-type: none">- Anteriore e Posteriore/ Front and Rear- Interno/Internal Ø: 410 mm- Altezza fascia/High band: 190 mm- Altezza totale/Total Height: 250 mm- Diametro mozzo/Bore hub: 285 mm- Interasse tra fori/Wheelbase between holes: 335 mm- Fori/Holes: 10/2/2- Fori/Holes Ø: 23-11/30-M12x1,75 | Eutotech Eurostar Eurotrakker Cursor |
| 932115  | 42118427 42102583 | <ul style="list-style-type: none">- Posteriore/Rear- Interno/Internal Ø: 410 mm- Altezza fascia/High band: 213 mm- Altezza totale/Total Height: 282,50 mm- Diametro mozzo/Bore hub: 285 mm- Interasse tra fori/Wheelbase between holes: 335 mm- Fori/Holes: 10/2/2- Fori/Holes Ø: 23-11SV-M12x1,75 | Eurotech Eurostar Eurotrakker Cursor |
| 932134  | 42118426 | <ul style="list-style-type: none">- Posteriore/Rear- Interno/Internal Ø: 410 mm- Altezza fascia/High band: 198 mm- Altezza totale/Total Height: 272,50 mm- Diametro mozzo/Bore hub: 285 mm- Interasse tra fori/Wheelbase between holes: 335 mm- Fori/Holes: 10/2/2- Fori/Holes Ø: 23-11SV-M12x1,75 | Eurotrakker Eurotrakker Cursor |
| 932132  | 7183049 | <ul style="list-style-type: none">- Anteriore/Front- Interno/Internal Ø: 410 mm- Altezza fascia/High band: 190 mm- Altezza totale/Total Height: 244 mm- Diametro mozzo/Bore hub: 285 mm- Interasse tra fori/Wheelbase between holes: 335 mm- Fori/Holes: 10/2/2- Fori/Holes Ø: 23-11SV-M12x1,75 | Eurotrakker Cursor |

**TAMBURI FRENO
BRAKE DRUMS
TAMBOURS DE FREIN
BREMSTROMMELN
ТОРМОЗНЫЕ БАРАБАНЫ
TAMBORES DE FRENO**

EMMERRE
spare parts for trucks and trailers

IVECO

| Applicazioni / Applications | Dettagli / Detail | Adattabile a / Adaptable to | Emmerre |
|---|---|-----------------------------|---------------|
| Eurotrakker Eurotrakker Cursor HD/C-HD7 (Astra) | - Posteriore/Rear - Interno/Internal Ø: 410 mm - Altezza fascia/High band: 213 mm - Altezza totale/Total Height: 289 mm - Diametro mozzo/Bore hub: 285 mm - Interasse tra fori/Wheelbase between holes: 335 mm - Fori/Holes: 10/1/2 - Fori/Holes Ø: 23-11/30-M12x1,75 | 7183050 115070 (Astra) | 932117 |
| Eurotech Eurostar Cursor | - Posteriore/Rear - Interno/Internal Ø: 410 mm - Altezza fascia/High band: 206 mm - Altezza totale/Total Height: 255 mm - Diametro mozzo/Bore hub: 285 mm - Interasse tra fori/Wheelbase between holes: 335 mm - Fori/Holes: 10/2/2 - Fori/Holes Ø: 23-11/30-M12x1,75 | 7183046 | 932119 |
| Eurotech Eurostar Eurotrakker Cursor | - Posteriore/Rear - Interno/Internal Ø: 410 mm - Altezza fascia/High band: 208 mm - Altezza totale/Total Height: 263 mm - Diametro mozzo/Bore hub: 285 mm - Interasse tra fori/Wheelbase between holes: 335 mm - Fori/Holes: 10/2/2 - Fori/Holes Ø: 23-11/30-M12x1,75 | 7183047 | 932120 |
| Eurotrakker Cursor Stralis | - Anteriore/Front - Interno/Internal Ø: 410 mm - Altezza fascia/High band: 190 mm - Altezza totale/Total Height: 257 mm - Diametro mozzo/Bore hub: 285 mm - Interasse tra fori/Wheelbase between holes: 335 mm - Fori/Holes: 10/2/2 - Fori/Holes Ø: 23-11/30-M12x1,75 | 7183048 | 932121 |

Tamburi Freno
Brake Drums

| Emmerre | Adattabile a / <i>Adaptable to</i> | Dettagli / <i>Detail</i> | Applicazioni / <i>Applications</i> |
|---|------------------------------------|---|------------------------------------|
| 932118 | 7177560 7165358 | <p>- Posteriore/Rear</p> <ul style="list-style-type: none"> - Interno/<i>Internal</i> Ø: 410 mm - Altezza fascia/<i>High band</i>: 230 mm - Altezza totale/<i>Total Height</i>: 275 mm - Diametro mozzo/<i>Bore hub</i>: 285 mm - Interasse tra fori/<i>Wheelbase between holes</i>: 335 mm - Fori/<i>Holes</i>: 10/2/2/2 - Fori/<i>Holes</i> Ø: 23-11/30-M12x1,75 - 11SV | 370 Bus Euroclass |
|  | | | |
| | | | |
| | | | |
| | | | |

**TAMBURI FRENO
BRAKE DRUMS
TAMBOURS DE FREIN
BREMSTROMMELN
ТОРМОЗНЫЕ БАРАБАНЫ
TAMBORES DE FRENO**

EMMERRE
spare parts for trucks and trailers

MAN

Tamburi Freno
Brake Drums

| Applicazioni / Applications | Dettagli / Detail | Adattabile a / Adaptable to | Emmerre |
|---|---|--|---------------|
| E 2000 F 90 F 2000 M 2000 M 90 TGA TGS TGX | - Anteriore/Front - Interno/Internal Ø: 410 mm - Altezza fascia/High band: 188 mm - Altezza totale/Total Hight: 232 mm - Diametro mozzo/Bore hub: 298 mm - Interasse tra fori/Wheelbase between holes: 335 mm - Fori/Holes: 10/2/3 - Fori/Holes Ø: 23-13/22-M12x1,5 | 81501100239 81501100232 81501100214 81501100227 | 932200 |
| E 2000 F 90 F 2000 M 2000 M 90 TGA TGS TGX | - Posteriore/Rear - Interno/Internal Ø: 410 mm - Altezza fascia/High band: 195 mm - Altezza totale/Total Hight: 280 mm - Diametro mozzo/Bore hub: 298 mm - Interasse tra fori/Wheelbase between holes: 335 mm - Fori/Holes: 10/5/3 - Fori/Holes Ø: 23-24-M12x1,5 | 81501100101 81501100241 | 932201 |
| E 2000 F 90 F 2000 M 2000 SG SL SR TGA TGS TGX | - Posteriore/Rear - Interno/Internal Ø: 410 mm - Altezza fascia/High band: 232 mm - Altezza totale/Total Hight: 300 mm - Diametro mozzo/Bore hub: 298 mm - Interasse tra fori/Wheelbase between holes: 335 mm - Fori/Holes: 10/5/3 - Fori/Holes Ø: 23-24/M12x1,5 | 81501100144 81501100104 81501100107 | 932203 |
| Series 19 22.240 Series 26 190.30 30.240/320 32.230/240 | - Posteriore/Rear - Interno/Internal Ø: 410 mm - Altezza fascia/High band: 173 mm - Altezza totale/Total Hight: 270 mm - Diametro mozzo/Bore hub: 298 mm - Interasse tra fori/Wheelbase between holes: 335 mm - Fori/Holes: 10/5/3 - Fori/Holes Ø: 23-24/M12x1,5 | 81501100102 | 932308 |



| Emmerre | Adattabile a / Adaptable to | Dettagli / Detail | Applicazioni / Applications |
|---------------|---|--|---|
| 932305 | 81501100213 81501100242 81501100118 | <p>- Anteriore/Front</p> <ul style="list-style-type: none"> - Interno/Internal Ø: 410 mm - Altezza fascia/High band: 171 mm - Altezza totale/Total Height: 249,50 mm - Diametro mozzo/Bore hub: 298 mm - Interasse tra fori/Wheelbase between holes: 335 mm - Fori/Holes: 10/5/3 - Fori/Holes Ø: 23-24/M12x1,5 | E 2000 F 90 F 2000 M 90 M 2000 TGA TGM TGS |
| 932303 | 81501100231 81501100108 81501100147 81501100223 81501100226 | <p>- Anteriore/Front</p> <ul style="list-style-type: none"> - Interno/Internal Ø: 410 mm - Altezza fascia/High band: 168 mm - Altezza totale/Total Height: 212 mm - Diametro mozzo/Bore hub: 298 mm - Interasse tra fori/Wheelbase between holes: 335 mm - Fori/Holes: 10/2/3 - Fori/Holes Ø: 23-13/22-M12x1,5 | E 2000 F 90 F 2000 M 90 M 2000 |
| | | | |
| | | | |



**TAMBURI FRENO
BRAKE DRUMS
TAMBOURS DE FREIN
BREMSTROMMELN
ТОРМОЗНЫЕ БАРАБАНЫ
TAMBORES DE FRENO**

EMMERRE
spare parts for trucks and trailers

MERCEDES

| Applicazioni / Applications | Dettagli / Detail | Adattabile a / Adaptable to | Emmerre |
|---|--|--|---------------|
| LK LN2 | - Posteriore/Rear - Interno/Internal Ø: 308 mm - Altezza fascia/High band: 130 mm - Altezza totale/Total Height: 293 mm - Diametro mozzo/Bore hub: 92 mm - Interasse tra fori/Wheelbase between holes: 112/205 mm - Fori/Holes: 8/6 - Fori/Holes Ø: M12-18 | 6733561202 6733560302 | 932300 |
| Atego Atego II LK LN2 0301 0309 0402 T2L | - Anteriore e Posteriore/Front and Rear - Interno/Internal Ø: 364 mm - Altezza fascia/High band: 173,50 mm - Altezza totale/Total Height: 210 mm - Diametro mozzo/Bore hub: 238 mm - Interasse tra fori/Wheelbase between holes: 275 mm - Fori/Holes: 8/3 - Fori/Holes Ø: 21-M12x1,5 | 6774210501 6774230501 6774230001 6774210101 | 932301 |
| Actros Actros MP2 Actros MP3 Atego Axor Axor II MK NG SK T2L | - Posteriore/Rear - Interno/Internal Ø: 410 mm - Altezza fascia/High band: 192 mm - Altezza totale/Total Height: 280 mm - Diametro mozzo/Bore hub: 298 mm - Interasse tra fori/Wheelbase between holes: 335 mm - Fori/Holes: 10/5/3 - Fori/Holes Ø: 23-24/M12x1,5 | 3464230501 3464230101 | 932302 |
| MK NG SK 0303 0305 0307 0404 0405 0408 | - Anteriore/Front - Interno/Internal Ø: 410 mm - Altezza fascia/High band: 168 mm - Altezza totale/Total Height: 212 mm - Diametro mozzo/Bore hub: 298 mm - Interasse tra fori/Wheelbase between holes: 335 mm - Fori/Holes: 10/2/3 - Fori/Holes Ø: 23-13/22-M12x1,5 | 3054210101 3054210401 3054230601 3564210001 | 932303 |



| Emmerre | Adattabile a / Adaptable to | Dettagli / Detail | Applicazioni / Applications |
|---------------|--|--|--|
| 932304 | 6244210201 | <p>- Anteriore/Front</p> <ul style="list-style-type: none"> - Interno/Internal Ø: 410 mm - Altezza fascia/High band: 191 mm - Altezza totale/Total Height: 237 mm - Diametro mozzo/Bore hub: 298 mm - Interasse tra fori/Wheelbase between holes: 335 mm - Fori/Holes: 10/3 - Fori/Holes Ø: 23-M12x1,5 | <ul style="list-style-type: none"> Actros MP2 Actros MP3 Axor II Econic MK NG OF/OH Series SK |
| 932305 | 3874210001 3464210301 | <p>- Anteriore/Front</p> <ul style="list-style-type: none"> - Interno/Internal Ø: 410 mm - Altezza fascia/High band: 171 mm - Altezza totale/Total Height: 249,50 mm - Diametro mozzo/Bore hub: 298 mm - Interasse tra fori/Wheelbase between holes: 335 mm - Fori/Holes: 10/5/3 - Fori/Holes Ø: 23-24-M12x1,5 | <ul style="list-style-type: none"> NG SK |
| 932306 | 3054230401 3054230301 | <p>- Posteriore/Rear</p> <ul style="list-style-type: none"> - Interno/Internal Ø: 410 mm - Altezza fascia/High band: 238 mm - Altezza totale/Total Height: 306 mm - Diametro mozzo/Bore hub: 298 mm - Interasse tra fori/Wheelbase between holes: 335 mm - Fori/Holes: 10/5/3 - Fori/Holes Ø: 23-24-M12x1,5 | <ul style="list-style-type: none"> Actros Actros MP2 Actros MP3 Atego Axor Axor II MK - NG - SK T2L Conecto |
| 932307 | 3014230801 3014230001 3014230901 3074230101 | <p>- Posteriore/Rear</p> <ul style="list-style-type: none"> - Interno/Internal Ø: 410 mm - Altezza fascia/: 238,50 mm - Altezza totale/Total Height: 306 mm - Diametro mozzo/Bore hub: 298 mm - Interasse tra fori/Wheelbase between holes: 335 mm - Fori/Holes: 10/3 - Fori/Holes Ø: 23-M12x1,5 | <ul style="list-style-type: none"> MK NG LK LN2 0303 0404 OF/OH Series |

TAMBURI FRENO
BRAKE DRUMS
TAMBOURS DE FREIN
BREMSTROMMELN
ТОРМОЗНЫЕ БАРАБАНЫ
TAMBORES DE FRENO

EMMERRE
spare parts for trucks and trailers

MERCEDES

| Applicazioni / Applications | Dettagli / Detail | Adattabile a / Adaptable to | Emmerre |
|--|---|-----------------------------|---------------|
| MK NG SK T2L | <ul style="list-style-type: none"> - Posteriore/Rear - Interno/Internal Ø: 410 mm - Altezza fascia/High band: 173 mm - Altezza totale/ 270 mm - Diametro mozzo/Bore hub: 298 mm - Interasse tra fori/Wheelbase between holes: 335 mm - Fori/Holes: 10/5/3 - Fori/Holes Ø: 23-24-M12x1,5 | 3464230601 3464230001 | 932308 |
| Actros Actros MP2 Actros MP3 Atego Axor Axor II MK - NG LK - LN2 - SK | <ul style="list-style-type: none"> - Anteriore/Front - Interno/Internal Ø: 410 mm - Altezza fascia/High band: 190 mm - Altezza totale/ Total Height: 237 mm - Diametro mozzo/Bore hub: 298 mm - Interasse tra fori/Wheelbase between holes: 335 mm - Fori/Holes: 10/3 - Fori/Holes Ø: 23-M12x1,5 | 6584210001 | 932309 |
| | | | |
| | | | |



Tamburi Freno
Brake Drums

| Emmerre | Adattabile a / Adaptable to | Dettagli / Detail | Applicazioni / Applications |
|---|-----------------------------|--|------------------------------|
| 960203 | 43206F3600 | <p>- Posteriore/Rear</p> <ul style="list-style-type: none"> - Interno/Internal Ø: 253 mm - Altezza fascia/High band: 65,50 mm - Altezza totale/Total Height: 88 mm - Diametro mozzo/Bore hub: 110 mm - Interasse tra fori/Wheelbase between holes: 160 mm - Fori/Holes: 5/2/2 - Fori/Holes Ø: 19-7/16-M6x1 | Cabstar Trade |
|  | | | |
| 960220 | 432069X201 43206F3901 | <p>- Posteriore/Rear</p> <ul style="list-style-type: none"> - Interno/Internal Ø: 280 mm - Altezza fascia/High band: 77 mm - Altezza totale/Total Height: 113,50 mm - Diametro mozzo/Bore hub: 110 mm - Interasse tra fori/Wheelbase between holes: 160 mm - Fori/Holes: 5/2/2 - Fori/Holes Ø: 19-7/16,5-M6x1 | Cabstar 120 |
|  | | | |
| 960204 | -06200387-0 | <p>- Posteriore/Rear</p> <ul style="list-style-type: none"> - Interno/Internal Ø: 308 mm - Altezza fascia/High band: 114 mm - Altezza totale/Total Height: 161,50 mm - Diametro mozzo/Bore hub: 130 mm - Interasse tra fori/Wheelbase between holes: 170 mm - Fori/Holes: 6/2/2 - Fori/Holes Ø: 21,5-9/18,5-M8 | Atleon 100 - 120 Eco T100 |
|  | | | |

**TAMBURI FRENO
BRAKE DRUMS
TAMBOURS DE FREIN
BREMSTROMMELN
ТОРМОЗНЫЕ БАРАБАНЫ
TAMBORES DE FRENO**

EMMERRE
spare parts for trucks and trailers

RENAULT

| Applicazioni / Applications | Dettagli / Detail | Adattabile a / Adaptable to | Emmerre |
|--|--|---|---------------|
| Magnum AE385 AE420 AE520 | - Posteriore/Rear - Interno/Internal Ø: 414 mm - Altezza fascia/: 234 mm - Altezza totale/Total Height: 277 mm - Diametro mozzo/Bore hub: 281 mm - Interasse tra fori/Wheelbase between holes: 335 mm - Fori/Holes: 10/2/2 - Fori/Holes Ø: 26,2-13/22-M14 | 5010098949 0000189923 | 932400 |
| GR350 TNR350 TR305 | - Anteriore/Front - Interno/Internal Ø: 414 mm - Altezza fascia/High band: 185 mm - Altezza totale/Total Height: 235 mm - Diametro mozzo/Bore hub: 281 mm - Interasse tra fori/Wheelbase between holes: 335 mm - Fori/Holes: 10/2/2 - Fori/Holes Ø: 26-13/22-M14 | 194435 189937 192371 5000737768 MBD1001 | 932401 |
| SM12 - 170 - 240 SM280 - 260 - 300 Turbo | - Anteriore/Front - Interno/Internal Ø: 410 mm - Altezza fascia/High band: 168 mm - Altezza totale/ 212 mm - Diametro mozzo/Bore hub: 298 mm - Interasse tra fori/Wheelbase between holes: 335 mm - Fori/Holes: 10/2/3 - Fori/Holes Ø: 23-13/22-M12x1,5 | 5000284413 | 932303 |
| SM300 | - Anteriore/Front - Interno/Internal Ø: 410 mm - Altezza fascia/High band: 171 mm - Altezza totale/Total Height: 249,50 mm - Diametro mozzo/Bore hub: 298 mm - Interasse tra fori/Wheelbase between holes: 335 mm - Fori/Holes: 10/5/3 - Fori/Holes Ø: 23-24-M12x1,5 | 5000281230 | 932305 |

| Emmerre | Adattabile a / Adaptable to | Dettagli / Detail | Applicazioni / Applications |
|---------------|-----------------------------|---|--|
| 932302 | 5000273586 5000285473 | <ul style="list-style-type: none"> - Posteriore/Rear - Interno/Internal Ø: 410 mm - Altezza fascia/High band: 192 mm - Altezza totale/Total Height: 280 mm - Diametro mozzo/Bore hub: 298 mm - Interasse tra fori/Wheelbase between holes: 335 mm - Fori/Holes: 10/5/3 - Fori/Holes Ø: 23-24-M12x1,5 | SM12 SM170 SM240 SM300 SM340 |
| 932308 | 5000280766 | <ul style="list-style-type: none"> - Posteriore/Rear - Interno/Internal Ø: 410 mm - Altezza fascia/High band: 173 mm - Altezza totale/Total Height: 270 mm - Diametro mozzo/Bore hub: 298 mm - Interasse tra fori/Wheelbase between holes: 335 mm - Fori/Holes: 10/5/3 - Fori/Holes Ø: 23-24-M12x1,5 | SM260 EPG176 |
| 932601 | 7420713926 7421451969 | <ul style="list-style-type: none"> - Anteriore/Front - Interno/Internal Ø: 410 mm - Altezza fascia/High band: 199 mm - Altezza totale/Total Height: 260 mm - Diametro mozzo/Bore hub: 282 mm - Interasse tra fori/Wheelbase between holes: 335 mm - Fori/Holes: 10/2/2 - Fori/Holes Ø: 28-M20/18 | Premium Kerax |
| 932402 | 5010260663 | <ul style="list-style-type: none"> - Anteriore e Posteriore/Front and Rear - Interno/Internal Ø: 414 mm - Altezza fascia/High band: 181 mm - Altezza totale/Total Height: 231 mm - Diametro mozzo/Bore hub: 280,80 mm - Interasse tra fori/Wheelbase between holes: 335 mm - Fori/Holes: 10 - Fori/Holes Ø: 25 | Kerax Magnum |

TAMBURI FRENO
BRAKE DRUMS
TAMBOURS DE FREIN
BREMSTROMMELN
ТОРМОЗНЫЕ БАРАБАНЫ
TAMBORES DE FRENO

EMMERRE
spare parts for trucks and trailers

RENAULT

| Applicazioni / Applications | Dettagli / Detail | Adattabile a / Adaptable to | Emmerre |
|--|---|-----------------------------|---------------|
| Kerax Manager Maxter Major Premium | <ul style="list-style-type: none"> - Anteriore/Front - Interno/Internal Ø: 414 mm - Altezza fascia/High band: 187 mm - Altezza totale/Total Hight: 233 mm - Diametro mozzo/Bore hub: 280,8 mm - Interasse tra fori/Wheelbase between holes: 335 mm - Fori/Holes: 10/2/2 - Fori/Holes Ø: 25-M14-13/22 | 5010136148 | 932404 |



Tamburi Freno
Brake Drums

| Emmerre | Adattabile a / Adaptable to | Dettagli / Detail | Applicazioni / Applications |
|---|---|---|-----------------------------|
| 932900 | 21220183V 21220183 21219028 | <ul style="list-style-type: none"> - Interno/Internal Ø: 419 mm - Altezza fascia/High band: 192 mm - Altezza totale/Total Height: 238 mm - Diametro mozzo/Bore hub: 282,60 mm - Interasse tra fori/Wheelbase between holes: 335 mm - Fori/Holes: 10/2/2 - Fori/Holes Ø: 24,2-14SV-M12x1,75 | Axle 9 ton Axle TM |
|  | | | |
| 932901 | 21211030S 21211030 | <ul style="list-style-type: none"> - Interno/Internal Ø: 350 mm - Altezza fascia/High band: 212 mm - Altezza totale/Total Height: 264 mm - Diametro mozzo/Bore hub: 182,90 mm - Interasse tra fori/Wheelbase between holes: 225 mm - Fori/Holes: 10/6 - Fori/Holes Ø: 24,2-M6 | Axle TM |
|  | | | |
| 932902 | 21209723S 21209723 21218963S | <ul style="list-style-type: none"> - Interno/Internal Ø: 311 mm - Altezza fascia/High band: 199 mm - Altezza totale/Total Height: 260,50 mm - Diametro mozzo/Bore hub: 183 mm - Interasse tra fori/Wheelbase between holes: 225 mm - Fori/Holes: 10/6 - Fori/Holes Ø: 24,5-M6 | Axle TM (ABS) |
|  | | | |
| 932903 | 21018986V 21018986 21021284 21021163 | <ul style="list-style-type: none"> - Interno/Internal Ø: 419 mm - Altezza fascia/High band: 203 mm - Altezza totale/Total Height: 248 mm - Diametro mozzo/Bore hub: 282,60 mm - Interasse tra fori/Wheelbase between holes: 335 mm - Fori/Holes: 10 - Fori/Holes Ø: 24,2 mm | Axle TA Axle TM |
|  | | | |

TAMBURI FRENO
BRAKE DRUMS
TAMBOURS DE FREIN
BREMSTROMMELN
ТОРМОЗНЫЕ БАРАБАНЫ
TAMBORES DE FRENO

EMMERRE
spare parts for trucks and trailers

ROR

| Applicazioni / Applications | Dettagli / Detail | Adattabile a / Adaptable to | Emmerre |
|-----------------------------|---|-----------------------------|---------------|
| Axle TA | - Interno/Internal Ø: 419 mm | 21021114AV | 932904 |
| Axle TM | - Altezza fascia/High band: 229,50 mm - Altezza totale/Total Height: 272 mm - Diametro mozzo/Bore hub: 282,60 mm - Interasse tra fori/Wheelbase between holes: 335 mm - Fori/Holes: 10 - Fori/Holes Ø: 24,2 mm | 21021114 | |
| | | | |
| | | | |
| | | | |



Tamburi Freno
Brake Drums

| Emmerre | Adattabile a / <i>Adaptable to</i> | Dettagli / <i>Detail</i> | Applicazioni / <i>Applications</i> |
|---------------|------------------------------------|--|------------------------------------|
| 932950 | 1064026002 1064026001 | <ul style="list-style-type: none"> - Interno/<i>Internal</i> Ø: 420 mm - Altezza fascia/<i>High band</i>: 195 mm - Altezza totale/<i>Total Height</i>: 227,50 mm - Bore hub: 300 mm - Interasse tra fori/<i>Wheelbase between holes</i>: 335 mm - Fori/<i>Holes</i>: 10 - Fori/<i>Holes</i> Ø: 23 mm | Axle SKRS 9020/9042 |
| 932951 | 1064023601 1064023600 | <ul style="list-style-type: none"> - Interno/<i>Internal</i> Ø: 420 mm - Altezza fascia/<i>High band</i>: 192,50 mm - Altezza totale/<i>Total Height</i>: 227,50 mm - Diametro mozzo/<i>Bore hub</i>: 290 mm - Interasse tra fori/<i>Wheelbase between holes</i>: 335 mm - Fori/<i>Holes</i>: 10/4 - Fori/<i>Holes</i> Ø: 23-M10 | Axle RSM |
| 932952 | 1064010801 1064012800 | <ul style="list-style-type: none"> - Interno/<i>Internal</i> Ø: 420 mm - Altezza fascia/<i>High band</i>: 212 mm - Altezza totale/<i>Total Height</i>: 256 mm - Diametro mozzo/<i>Bore hub</i>: 290 mm - Interasse tra fori/<i>Wheelbase between holes</i>: 335 mm - Fori/<i>Holes</i>: 10 - Fori/<i>Holes</i> Ø: 23 mm | Axle RSM RS |
| 932802 | 1064005705 1064005706 | <ul style="list-style-type: none"> - Interno/<i>Internal</i> Ø: 420 mm - Altezza fascia/<i>High band</i>: 193 mm - Altezza totale/<i>Total Height</i>: 246,50 mm - Diametro mozzo/<i>Bore hub</i>: 290 mm - Interasse tra fori/<i>Wheelbase between holes</i>: 335 mm - Fori/<i>Holes</i>: 10 - Fori/<i>Holes</i> Ø: 23 mm - Con mozzo/<i>With Hub</i> | Axle 8-9 ton |

**TAMBURI FRENO
BRAKE DRUMS
TAMBOURS DE FREIN
BREMSTROMMELN
ТОРМОЗНЫЕ БАРАБАНЫ
TAMBORES DE FRENO**

EMMERRE
spare parts for trucks and trailers

SAF

| Applicazioni / Applications | Dettagli / Detail | Adattabile a / Adaptable to | Emmerre |
|-----------------------------|---|-----------------------------|---------------|
| Axle SKRS- RZ9042-11242 | <ul style="list-style-type: none"> - Interno/Internal Ø: 420 mm - Altezza fascia/High band: 213 mm - Altezza totale/Total Hight: 255 mm - Diametro mozzo/Bore hub: 300 mm - Interasse tra fori/Wheelbase between holes: 335 mm - Fori/Holes: 10 - Fori/Holes Ø: 23 mm | 1064027000 1064027001 | 932953 |
| Axle 419x178 | <ul style="list-style-type: none"> - Interno/Internal Ø: 419 mm - Altezza fascia/High band: 188 mm - Altezza totale/Total Hight: 225 mm - Diametro mozzo/Bore hub: 290 mm - Interasse tra fori/Wheelbase between holes: 335 mm - Fori/Holes: 10/2/2 - Fori/Holes Ø: 27-10,5/15-M14 | 1064016500 1064018500 | 932850 |
| Axle SNK 300x200 10F | <ul style="list-style-type: none"> - Interno/Internal Ø: 300 mm - Altezza fascia/High band: 200 mm - Altezza totale/Total Hight: 280 mm - Diametro mozzo/Bore hub: 190 mm - Fori/Holes: 10 - Fori/Holes Ø: 23 mm | 1064027300 | 932954 |



EMMERRE

spare parts for trucks and trailers

SCANIA

TAMBURI FRENO
BRAKE DRUMS
TAMBOURS DE FREIN
BREMSTROMMELN
ТОРМОЗНЫЕ БАРАБАНЫ
TAMBORES DE FRENO

| Emmerre | Adattabile a / Adaptable to | Dettagli / Detail | Applicazioni / Applications |
|--|--|---|--|
| 932500  | 1414435 342880 1385893 293543 305438 360573 | - Anteriore e Posteriore/ Front and Rear - Interno/ Internal Ø: 413 mm - Altezza fascia/ High band: 266 mm - Altezza totale/ Total Height: 320 mm - Diametro mozzo/ Bore hub: 295 mm - Interasse tra fori/ Wheelbase between holes: 335 mm - Fori/ Holes: 10/2/3 - Fori/ Holes Ø: 23,5-13SV-M12x1,75 | R94 L94 112H K113 114 144 Series P/G/R/T |
| 932501  | 392390 | - Anteriore/ Front - Interno/ Internal Ø: 413 mm - Altezza fascia/ High band: 189 mm - Altezza totale/ Total Height: 254 mm - Diametro mozzo/ Bore hub: 295 mm - Interasse tra fori/ Wheelbase between holes: 335 mm - Fori/ Holes: 10/3/2 - Fori/ Holes Ø: 23,5-M12x1,75-13SV | L113 M143 |
| 932502  | 360572 277308 305406 | - Con mozzo/ With Hub - Posteriore/ Rear - Interno/ Internal Ø: 413 mm - Altezza fascia/ High band: 216 mm - Altezza totale/ Total Height: 296 mm - Diametro mozzo/ Bore hub: 295 mm - Interasse tra fori/ Wheelbase between holes: 335 mm - Fori/ Holes: 10/2/3 - Fori/ Holes Ø: 23,5-13SV-M12x1,75 | LB 140 - 142 SB 104 - 142 |
| 932503  | 1414152 1334075 | - Anteriore/ Front - Interno/ Internal Ø: 413 mm - Altezza fascia/ High band: 189 mm - Altezza totale/ Total Height: 263 mm - Diametro mozzo/ Bore hub: 295 mm - Interasse tra fori/ Wheelbase between holes: 335 mm - Fori/ Holes: 10/2/3/2 - Fori/ Holes Ø: 23,5-13SV-M12x1,75-9/23,50 | Series 113 - 143 - 144 Series P/G/R/T Series 4 |

TAMBURI FRENO
BRAKE DRUMS
TAMBOURS DE FREIN
BREMSTROMMELN
ТОРМОЗНЫЕ БАРАБАНЫ
TAMBORES DE FRENO

EMMERRE
spare parts for trucks and trailers

SCANIA

| Applicazioni / Applications | Dettagli / Detail | Adattabile a / Adaptable to | Emmerre |
|--|--|-----------------------------|---------------|
| Series 143 - 144 Series P/G/R/T Series 4 | <ul style="list-style-type: none"> - Anteriore e Posteriore/ Front and Rear - Interno/ Internal Ø: 413 mm - Altezza fascia/ High band: 214 mm - Altezza totale/ Total Height: 275 mm - Diametro mozzo/ Bore hub: 295 mm - Interasse tra fori/ Wheelbase between holes: 335 mm - Fori/ Holes: 10/3 - Fori/ Holes Ø: 24-9/24-M12x1,75 | 1414153 1361331 | 932504 |



Tamburi Freno
Brake Drums

| Emmerre | Adattabile a / Adaptable to | Dettagli / Detail | Applicazioni / Applications |
|---------------|---------------------------------|---|-----------------------------|
| 932700 | 449555 AJB0465001 M006166 | - Interno/ <i>Internal</i> Ø: 419 mm - Altezza fascia/ <i>High band</i> : 198 mm - Altezza totale/ <i>Total Height</i> : 244 mm - Diametro mozzo/ <i>Bore hub</i> : 288 mm - Interasse tra fori/ <i>Wheelbase between holes</i> : 335 mm - Fori/ <i>Holes</i> : 10/2/2 - Fori/ <i>Holes</i> Ø: 26,5-10/15-M14x2 | Axle 9-10 ton 419 x 178 |
| 932701 | 449628 AJB0465002 M003176 | - Interno/ <i>Internal</i> Ø: 419 mm - Altezza fascia/ <i>High band</i> : 211 mm - Altezza totale/ <i>Total Height</i> : 256 mm - Diametro mozzo/ <i>Bore hub</i> : 288 mm - Interasse tra fori/ <i>Wheelbase between holes</i> : 335 mm - Fori/ <i>Holes</i> : 10/2/2 - Fori/ <i>Holes</i> Ø: 26,5-9/15-M14x2 | Axle 12 ton 419 x 203 |
| | | | |
| | | | |



TAMBURI FRENO
BRAKE DRUMS
TAMBOURS DE FREIN
BREMSTROMMELN
ТОРМОЗНЫЕ БАРАБАНЫ
TAMBORES DE FRENO

EMMERRE
spare parts for trucks and trailers

TRAILOR

| Applicazioni / Applications | Dettagli / Detail | Adattabile a / Adaptable to | Emmerre |
|-----------------------------|---|---|---------------|
| Trailor S32 417x178 | <ul style="list-style-type: none"> - Interno/Internal Ø: 419 mm - Altezza fascia/High band: 188 mm - Altezza totale/Total Height: 225 mm - Diametro mozzo/Bore hub: 290 mm - Interasse tra fori/Wheelbase between holes: 335 mm - Fori/Holes: 10/2/2 - Fori/Holes Ø: 27-10,50/15-M14 | <ul style="list-style-type: none"> 6502796E 6050055 6502781X | 932850 |



EMMERRE

spare parts for trucks and trailers

VIBERTI

TAMBURI FRENO
BRAKE DRUMS
TAMBOURS DE FREIN
BREMSTROMMELN
ТОРМОЗНЫЕ БАРАБАНЫ
TAMBORES DE FRENO

| Emmerre | Adattabile a / Adaptable to | Dettagli / Detail | Applicazioni / Applications |
|---|-----------------------------|---|---------------------------------|
| 932800  EMMERRE MODIFICATION | 125779411 | <ul style="list-style-type: none">- Interno/Internal Ø: 420 mm- Altezza fascia/High band: 190 mm- Altezza totale/Total Height: 250 mm- Diametro mozzo/Bore hub: 290 mm- Interasse tra fori/Wheelbase between holes: 335 mm- Fori/Holes: 10- Fori/Holes Ø: 23 mm- Con mozzo/With Hub | Series H/R 8 ton BPW |
| 932801  EMMERRE MODIFICATION | 125779417 | <ul style="list-style-type: none">- Interno/Internal Ø: 420 mm- Altezza fascia/High band: 191 mm- Altezza totale/Total Height: 226 mm- Diametro mozzo/Bore hub: 290 mm- Interasse tra fori/Wheelbase between holes: 335 mm- Fori/Holes: 10- Fori/Holes Ø: 23 mm- Con mozzo/With Hub | Series H/R 9 ton BPW |
| 932802  EMMERRE MODIFICATION | 125779404 | <ul style="list-style-type: none">- Interno/Internal Ø: 420 mm- Altezza fascia/High band: 193 mm- Altezza totale/Total Height: 246,50 mm- Diametro mozzo/Bore hub: 290 mm- Interasse tra fori/Wheelbase between holes: 335 mm- Fori/Holes: 10- Fori/Holes Ø: 23 mm- Con mozzo/With Hub | 1° Series 8-9 ton BPW SAF |
| 932803  EMMERRE MODIFICATION | 125779416 | <ul style="list-style-type: none">- Interno/Internal Ø: 420 mm- Altezza fascia/High band: 191 mm- Altezza totale/Total Height: 226 mm- Diametro mozzo/Bore hub: 290 mm- Interasse tra fori/Wheelbase between holes: 335 mm- Fori/Holes: 10- Fori/Holes Ø: 23 mm | System Eco Maxx BPW |

**TAMBURI FRENO
BRAKE DRUMS
TAMBOURS DE FREIN
BREMSTROMMELN
ТОРМОЗНЫЕ БАРАБАНЫ
TAMBORES DE FRENO**

EMMERRE
spare parts for trucks and trailers

VIBERTI

| Applicazioni / Applications | Dettagli / Detail | Adattabile a / Adaptable to | Emmerre |
|--|---|-----------------------------|---------------|
| Series NH/NR - Axle 15" 10-12 ton BPW | <ul style="list-style-type: none"> - Interno/Internal Ø: 300 mm - Altezza fascia/High band: 211 mm - Altezza totale/Total Height: 260 mm - Diametro mozzo/Bore hub: 190 mm - Interasse tra fori/Wheelbase between holes: 225 mm - Fori/Holes: 10 - Fori/Holes Ø: 23 mm | -- | 932805 |
| Series H/R 12 ton BPW | <ul style="list-style-type: none"> - Interno/Internal Ø: 420 mm - Altezza fascia/High band: 219 mm - Altezza totale/Total Height: 287 mm - Diametro mozzo/Bore hub: 290 mm - Interasse tra fori/Wheelbase between holes: 335 mm - Fori/Holes: 10 - Fori/Holes Ø: 23 mm - Con mozzo/With Hub | 125779408 125779419 | 932806 |
| Series NH/NR 10-12 ton BPW | <ul style="list-style-type: none"> - Interno/Internal Ø: 300 mm - Altezza fascia/High band: 218 mm - Altezza totale/Total Height: 295 mm - Diametro mozzo/Bore hub: 190 mm - Interasse tra fori/Wheelbase between holes: 225 mm - Fori/Holes: 10 - Fori/Holes Ø: 23 mm | 125779902 | 932807 |
| Serie H/R last type BPW 12 ton | <ul style="list-style-type: none"> - Interno/Internal Ø: 420 mm - Altezza fascia/High band: 213 mm - Altezza totale/Total Height: 259 mm - Diametro mozzo/Bore hub: 290 mm - Interasse tra fori/Wheelbase between holes: 335 mm - Fori/Holes: 10 - Fori/Holes Ø: 23 mm - Con mozzo/With Hub | -- | 932808 |

Tamburi Freno
Brake Drums

EMMERRE

spare parts for trucks and trailers

VIBERTI

TAMBURI FRENO
BRAKE DRUMS
TAMBOURS DE FREIN
BREMSTROMMELN
ТОРМОЗНЫЕ БАРАБАНЫ
TAMBORES DE FRENO

| Emmerre | Adattabile a / Adaptable to | Dettagli / Detail | Applicazioni / Applications |
|---|-----------------------------|---|--|
| 932809  EMMERRE MODIFICATION | 125779905 | <ul style="list-style-type: none">- Interno/<i>Internal</i> Ø: 360 mm- Altezza fascia/<i>High band</i>: 209 mm- Altezza totale/<i>Total Height</i>: 262 mm- Diametro mozzo/<i>Bore hub</i>: 190 mm- Interasse tra fori/<i>Wheelbase between holes</i>: 225 mm- Fori/<i>Holes</i>: 10- Fori/<i>Holes</i> Ø: 23 mm | Series KH/KR Axle 19" 1/2 10-12 ton BPW |
| 932810  | 125779401 | <ul style="list-style-type: none">- Interno/<i>Internal</i> Ø: 420 mm- Altezza fascia/<i>High band</i>: 210 mm- Altezza totale/<i>Total Height</i>: 238,50 mm- Diametro mozzo/<i>Bore hub</i>: 290 mm- Interasse tra fori/<i>Wheelbase between holes</i>: 335 mm- Fori/<i>Holes</i>: 6- Fori/<i>Holes</i> Ø: 20,50 mm- Con raggera/<i>With ray</i> | Series H/R 11-13 ton BPW |
| 932811  | 125779409 | <ul style="list-style-type: none">- Interno/<i>Internal</i> Ø: 420 mm- Altezza fascia/<i>High band</i>: 202 mm- Altezza totale/<i>Total Height</i>: 247 mm- Diametro mozzo/<i>Bore hub</i>: 290 mm- Interasse tra fori/<i>Wheelbase between holes</i>: 335 mm- Fori/<i>Holes</i>: 6- Fori/<i>Holes</i> Ø: 21 mm- Con raggera/<i>With ray</i> | Series H/R 12-14 ton BPW |
| 932818  EMMERRE MODIFICATION | 125779418 | <ul style="list-style-type: none">- Interno/<i>Internal</i> Ø: 420 mm- Altezza fascia/<i>High band</i>: 225 mm- Altezza totale/<i>Total Height</i>: 286 mm- Diametro mozzo/<i>Bore hub</i>: 290 mm- Interasse tra fori/<i>Wheelbase between holes</i>: 335 mm- Fori/<i>Holes</i>: 10- Fori/<i>Holes</i> Ø: 23 mm | Eco - Maxx 12-14 ton BPW |

TAMBURI FRENO
BRAKE DRUMS
TAMBOURS DE FREIN
BREMSTROMMELN
ТОРМОЗНЫЕ БАРАБАНЫ
TAMBORES DE FRENO

EMMERRE
spare parts for trucks and trailers

VIBERTI

| Applicazioni / Applications | Dettagli / Detail | Adattabile a / Adaptable to | Emmerre |
|-----------------------------|---|-----------------------------|---------------|
| Axle 11 ton BPW | <ul style="list-style-type: none"> - Interno/Internal Ø: 420 mm - Altezza fascia/High band: 214 mm - Altezza totale/Total Height: 275 mm - Diametro mozzo/Bore hub: 290 mm - Interasse tra fori/Wheelbase between holes: 335 mm - Fori/Holes: 10 - Fori/Holes Ø: 23 mm | 125779405 | 932814 |



EMMERRE

spare parts for trucks and trailers

VOLVO

TAMBURI FRENO
BRAKE DRUMS
TAMBOURS DE FREIN
BREMSTROMMELN
ТОРМОЗНЫЕ БАРАБАНЫ
TAMBORES DE FRENO

| Emmerre | Adattabile a / Adaptable to | Dettagli / Detail | Applicazioni / Applications |
|--|--------------------------------|--|--|
| 932615  | 1075312 1599014 | <ul style="list-style-type: none">- Interno/Internal Ø: 410 mm- Altezza fascia/High band: 173 mm- Altezza totale/Total Height: 235 mm- Diametro mozzo/Bore hub: 282 mm- Interasse tra fori/Wheelbase between holes: 335 mm- Fori/Holes: 10- Fori/Holes Ø: 28 | FH 12 FH 16 FL 10/12/7 FM 10/12/7/9 |
| 932600  | 1599012 | <ul style="list-style-type: none">- Posteriore/Rear- Interno/Internal Ø: 410 mm- Altezza fascia/High band: 230 mm- Altezza totale/Total Height: 307 mm- Diametro mozzo/Bore hub: 282 mm- Interasse tra fori/Wheelbase between holes: 335 mm- Fori/Holes: 10/2/2- Fori/Holes Ø: 28-M20-14SV | F 12 N 12 FH 12 FH 16 FL 7 FL 10 FL 12 |
| 932601  | 3171744 1075306 21094122 | <ul style="list-style-type: none">- Anteriore/Front- Interno/Internal Ø: 410 mm- Altezza fascia/High band: 199 mm- Altezza totale/Total Height: 260 mm- Diametro mozzo/Bore hub: 282 mm- Interasse tra fori/Wheelbase between holes: 335 mm- Fori/Holes: 10/2/2- Fori/Holes Ø: 28-M20/18 | F 10/12 FH FL FM N 10/12 |
| 932602  | 6772133 | <ul style="list-style-type: none">- Anteriore e Posteriore/Front and Rear- Interno/Internal Ø: 360 mm- Altezza fascia/High band: 184 mm- Altezza totale/Total Height: 247 mm- Diametro mozzo/Bore hub: 228 mm- Interasse tra fori/Wheelbase between holes: 275 mm- Fori/Holes: 8/2- Fori/Holes Ø: 21,5-M12 | FL6 |

**TAMBURI FRENO
BRAKE DRUMS
TAMBOURS DE FREIN
BREMSTROMMELN
ТОРМОЗНЫЕ БАРАБАНЫ
TAMBORES DE FRENO**

EMMERRE
spare parts for trucks and trailers

VOLVO

| Applicazioni / Applications | Dettagli / Detail | Adattabile a / Adaptable to | Emmerre |
|---|---|-----------------------------|---------------|
| FL6 | <ul style="list-style-type: none"> - Anteriore e Posteriore/ Front and Rear - Interno/ Internal Ø: 360 mm - Altezza fascia/ High band: 151,50 mm - Altezza totale/ Total Height: 232 mm - Diametro mozzo/ Bore hub: 228 mm - Interasse tra fori/ Wheelbase between holes: 275 mm - Fori/ Holes: 8/2 - Fori/ Holes Ø: 21,50-M12 | 1071112 | 932610 |
| FH FL FM NH | <ul style="list-style-type: none"> - Anteriore/ Front - Interno/ Internal Ø: 410 mm - Altezza fascia/ High band: 195 mm - Altezza totale/ Total Height: 261 mm - Diametro mozzo/ Bore hub: 282 mm - Interasse tra fori/ Wheelbase between holes: 335 mm - Fori/ Holes: 10/2/2 - Fori/ Holes Ø: 28-M20/14SV | 1599009 | 932603 |
| F 10 F 12 F 165 FH FL FM | <ul style="list-style-type: none"> - Posteriore/ Rear - Interno/ Internal Ø: 410 mm - Altezza fascia/ High band: 215 mm - Altezza totale/ Total Height: 295 mm - Diametro mozzo/ Bore hub: 282 mm - Interasse tra fori/ Wheelbase between holes: 335 mm - Fori/ Holes: 10/2/2 - Fori/ Holes Ø: 28-M20/14SV | 1599011 | 932604 |
| F 12 F 16 FH FL 10/7 | <ul style="list-style-type: none"> - Anteriore/ Front - Interno/ Internal Ø: 410 mm - Altezza fascia/ High band: 205 mm - Altezza totale/ Total Height: 274 mm - Diametro mozzo/ Bore hub: 282 mm - Interasse tra fori/ Wheelbase between holes: 335 mm - Fori/ Holes: 10/2/2 - Fori/ Holes Ø: 28-M20x14SV | 1599010 15990104 | 932605 |

EMMERRE

spare parts for trucks and trailers

VOLVO

TAMBURI FRENO
BRAKE DRUMS
TAMBOURS DE FREIN
BREMSTROMMELN
ТОРМОЗНЫЕ БАРАБАНЫ
TAMBORES DE FRENO

| Emmerre | Adattabile a / Adaptable to | Dettagli / Detail | Applicazioni / Applications |
|--|--|---|---|
| 932606  | 3171748 1075310 21094124 21451968 21508813 | - Posteriore/Rear - Interno/Internal Ø: 410 mm - Altezza fascia/High band: 232 mm - Altezza totale/Total Height: 306 mm - Diametro mozzo/Bore hub: 282 mm - Interasse tra fori/Wheelbase between holes: 335 mm - Fori/Holes: 10/2/2 - Fori/Holes Ø: 28-M20/18SV | F 12 FH FL FM N 12 |
| 932608  | 1075309 3171747 21094123 21508812 7420713927 7421359819 7421451973 | - Posteriore/Rear - Interno/Internal Ø: 410 mm - Altezza fascia/High band: 218 mm - Altezza totale/Total Height: 294 mm - Diametro mozzo/Bore hub: 282 mm - Interasse tra fori/Wheelbase between holes: 335 mm - Fori/Holes: 10/2/2 - Fori/Holes Ø: 28-M20x18SV | FH 12 - 16 FL 7 - 10 - 12 FL 16 FM 7 - 9 FM 10-12 NH |
| 932609  | 1075307 3171745 | - Anteriore/Front - Interno/Internal Ø: 410 mm - Altezza fascia/High band: 218 mm - Altezza totale/Total Height: 273 mm - Diametro mozzo/Bore hub: 282 mm - Interasse tra fori/Wheelbase between holes: 335 mm - Fori/Holes: 10/2/2 - Fori/Holes Ø: 28/18-M20x2,5 | F 12 - 13 (3° Axle) FH FL FM |
| 932607  | 1134817 | - Anteriore/Front - Interno/Internal Ø: 394 mm - Altezza fascia/High band: 219,50 mm - Altezza totale/Total Height: 269 mm - Diametro mozzo/Bore hub: 282 mm - Interasse tra fori/Wheelbase between holes: 335 mm - Fori/Holes: 10/2 - Fori/Holes Ø: 28-M12 | BUS B10 |

TAMBURI FRENO
BRAKE DRUMS
TAMBOURS DE FREIN
BREMSTROMMELN
ТОРМОЗНЫЕ БАРАБАНЫ
TAMBORES DE FRENO

EMMERRE
spare parts for trucks and trailers

VOLVO

| Applicazioni / Applications | Dettagli / Detail | Adattabile a / Adaptable to | Emmerre |
|-----------------------------|---|-----------------------------|---------------|
| Bus B10M - BOR | <ul style="list-style-type: none"> - Posteriore/Rear - Interno/Internal Ø: 394 mm - Altezza fascia/High band: 266 mm - Altezza totale/Total Hight: 314 mm - Diametro mozzo/Bore hub: 282 mm - Interasse tra fori/Wheelbase between holes: 335 mm - Fori/Holes: 10/2 - Fori/Holes Ø: 28-M12 | 1590313 | 932614 |



Tamburi Freno
Brake Drums

Emmerre

Adattabile a / *Adaptable to*

Dettagli / *Detail*

Applicazioni / *Applications*



MOZZI RUOTA

WHEEL HUBS
MOYEURS DE ROUE
RADNABEN
СТУПІЦЫ КОЛЕС
BUJES DE RUEDA

NEWS

| Emmerre | Descrizione/Description | Adattabile/Adaptable to | Pagina/Page |
|---------------|---|-------------------------|----------------|
| 931458 | Mozzo Ruota con Cuscinetti Skf, Abs e Calotta OE / Wheel Hub with Skf Bearings, Abs and OE Cover | BPW | 127 |
| 931464 | Mozzo Ruota con Cuscinetti Skf e Calotta OE / Wheel Hub with Skf Bearings and OE Cover | BPW | 128 |
| 931459 | Mozzo Ruota con Cuscinetti Skf e Calotta OE / Wheel Hub with Skf Bearings and OE Cover | BPW | 129 |
| 931460 | Mozzo Ruota con Cuscinetti Skf, Abs e Calotta OE / Wheel Hub with Skf Bearings, Abs and OE Cover | BPW | 130 |
| 931461 | Mozzo Ruota con Cuscinetti Skf e Calotta OE / Wheel Hub with Skf Bearings and OE Cover | BPW | 131 |
| 931375 | Mozzo Ruota con Cuscinetti Skf e Calotta OE / Wheel Hub with Skf Bearings and OE Cover | BPW | 132 |
| 931376 | Mozzo Ruota con Cuscinetti Skf e Calotta OE / Wheel Hub with Skf Bearings and OE Cover | BPW | 133 |
| 931377 | Mozzo Ruota con Cuscinetti Skf e Calotta OE / Wheel Hub with Skf Bearings and OE Cover | BPW | 134 |
| 931463 | Mozzo Ruota con Cuscinetti Skf, Abs e Calotta OE-Nostra Modifica / Wheel Hub with Skf Bearings, Abs and OE Cover-Our Modification | BPW | 135 |
| 931381 | Mozzo Ruota con Cuscinetti Skf, Abs e Calotta OE-Nostra Modifica / Wheel Hub with Skf Bearings, Abs and OE Cover-Our Modification | BPW | 136 |
| 931373 | Mozzo Ruota / Wheel Hub | BPW | 137 |
| 931462 | Mozzo Ruota con Cuscinetti Skf e Calotta OE / Wheel Hub with Skf Bearings and OE Cover | BPW | 137 |
| 931369 | Mozzo Ruota con Abs / Wheel Hub with Abs | BPW | 138 |
| 931393 | Mozzo Ruota con Cuscinetti, Abs e Calotta / Wheel Hub with Bearings, Abs and Cover | BPW | 138 |
| 931465 | Mozzo Ruota con Cuscinetti Skf, Abs e Calotta OE / Wheel Hub with Skf Bearings, Abs and OE Cover | BPW | 138 |
| 931382 | Mozzo Ruota / Wheel Hub | BPW | 139 |
| 931383 | Mozzo Ruota con Cuscinetti e Calotta / Wheel Hub with Bearings and Cover | BPW | 139 |
| 931492 | Mozzo Ruota con Cuscinetti Skf e Calotta OE / Wheel Hub with Skf Bearings and OE Cover | BPW | 139 |
| 931374 | Mozzo Ruota con Cuscinetti Skf, Abs e Calotta OE / Wheel Hub with Skf Bearings, Abs and OE Cover | BPW | 140 |
| 931386 | Mozzo Ruota / Wheel Hub | BPW | 140 |
| 931392 | Mozzo Ruota con Cuscinetti, Abs e Calotta / Wheel Hub with Bearings, Abs and Cover | BPW | 140 |
| 931370 | Mozzo Ruota con Cuscinetti Skf, Abs e Calotta OE / Wheel Hub with Skf Bearings, Abs and OE Cover | BPW | 141 |
| 931371 | Mozzo Ruota con Cuscinetti, Abs e Calotta / Wheel Hub with Bearings, Abs and Cover | BPW | 141 |
| 931372 | Mozzo Ruota / Wheel Hub | BPW | 141 |
| 931481 | Mozzo Ruota / Wheel Hub | BPW | 142 |
| 931482 | Mozzo Ruota con Cuscinetti, Abs e Calotta / Wheel Hub with Bearings, Abs and Cover | BPW | 142 |
| 931484 | Mozzo Ruota con Cuscinetti Skf, Abs e Calotta OE / Wheel Hub with Skf Bearings, Abs and OE Cover | BPW | 142 |
| 931385 | Mozzo Ruota con Abs / Wheel Hub with Abs | BPW | 143 |
| 931391 | Mozzo Ruota con Cuscinetti, Abs e Calotta / Wheel Hub with Bearings, Abs and Cover | BPW | 143 |
| 931466 | Mozzo Ruota con Cuscinetti Skf, Abs e Calotta OE / Wheel Hub with Skf Bearings, Abs and OE Cover | BPW | 143 |
| 931483 | Mozzo Ruota / Wheel Hub | BPW | 143 |
| 931479 | Mozzo Ruota / Wheel Hub | BPW | 144 |
| 931480 | Mozzo Ruota / Wheel Hub | BPW | 144 |
| 931485 | Mozzo Ruota / Wheel Hub | BPW | 144 |
| 931750 | Mozzo Ruota con Cuscinetti, Abs e Calotta / Wheel Hub with Bearings, Abs and Cover | DAF | 145 |
| 931753 | Mozzo Ruota con Cuscinetti e Abs / Wheel Hub with Bearings and Abs | DAF | 145 |
| 931850 | Mozzo Ruota con Cuscinetti Fag e Abs / Wheel Hub with Fag Bearings and Abs | DAF | 145 |
| 931853 | Mozzo Ruota con Cuscinetti Fag e Abs / Wheel Hub with Fag Bearings and Abs | DAF | 145 |
| 931749 | Mozzo Ruota Posteriore con Cuscinetti Fag e Abs / Rear Wheel Hub with Fag Bearings and Abs | DAF | 146 |
| 931754 | Mozzo Ruota Posteriore con Cuscinetti e Abs / Rear Wheel Hub with Bearings and Abs | DAF | 146 |
| 931755 | Mozzo Ruota con Cuscinetti e Abs / Wheel Hub with Bearings and Abs | DAF | 146 |
| 931855 | Mozzo Ruota con Cuscinetti Fag e Abs / Wheel Hub with Fag Bearings and Abs | DAF | 146 |
| 931751 | Mozzo Ruota con Cuscinetti e Abs / Wheel Hub with Bearings and Abs | DAF | 147 |
| 931752 | Mozzo Ruota con Cuscinetti e Abs / Wheel Hub with Bearings and Abs | DAF | 147 |
| 931851 | Mozzo Ruota con Cuscinetti Fag e Abs / Wheel Hub with Fag Bearings and Abs | DAF | 147 |
| 931852 | Mozzo Ruota con Cuscinetti Fag e Abs / Wheel Hub with Fag Bearings and Abs | DAF | 147 |
| 931487 | Mozzo Ruota Anteriore con Cuscinetti e Abs / Front Wheel Hub with Bearings and Abs | DAF-RENAULT | 148-179 |
| 931139 | Mozzo Ruota Posteriore con Cuscinetto Skf e Colonneta / Rear Wheel Hub with Skf Bearing and Bolts | IVECO | 151 |
| 931142 | Mozzo Ruota Posteriore con Cuscinetto e Colonneta / Rear Wheel Hub with Bearing and Bolts | IVECO | 151 |
| 931143 | Mozzo Ruota Posteriore con Cuscinetto e Colonneta / Rear Wheel Hub with Bearing and Bolts | IVECO | 151 |

| Emmerre | Descrizione/Description | Adattabile/Adaptable to | Pagina/Page |
|-----------------|--|-------------------------|----------------|
| 931116 | Mozzo Ruota Anteriore con Cuscinetto Skf / Front Wheel Hub with Skf Bearing | IVECO | 152 |
| 931138 | Mozzo Ruota Posteriore con Cuscinetto Skf e Colonnette / Rear Wheel Hub with Skf Bearing and Bolts | IVECO | 152 |
| 931115 | Mozzo Ruota Anteriore con Cuscinetto Skf e Abs / Front Wheel Hub with Skf Bearing and Abs | IVECO | 153 |
| 931137 | Mozzo Ruota Posteriore con Cuscinetto Skf e Colonnette / Rear Wheel Hub with Skf Bearing and Bolts | IVECO | 153 |
| 931144 | Mozzo Ruota Posteriore con Cuscinetti e Colonnette / Rear Wheel Hub with Bearings and Bolts | IVECO | 153 |
| 931117 | Mozzo Ruota Anteriore con Cuscinetto Skf / Front Wheel Hub with Skf Bearing | IVECO | 154 |
| 931168 | Mozzo Ruota Anteriore con Cuscinetto Skf / Front Wheel Hub with Skf Bearing | IVECO | 154 |
| 931118 | Mozzo Ruota Anteriore con Cuscinetto Skf e Abs / Front Wheel Hub with Skf Bearing and Abs | IVECO | 155 |
| 931119 | Mozzo Ruota Anteriore con Cuscinetto Skf e Abs / Front Wheel Hub with Skf Bearing and Abs | IVECO | 156 |
| 931140 | Mozzo Ruota Anteriore con Cuscinetto Skf e Abs / Front Wheel Hub with Skf Bearing and Abs | IVECO | 157 |
| 931141 | Mozzo Ruota Anteriore con Cuscinetto Skf e Abs / Front Wheel Hub with Skf Bearing and Abs | IVECO | 157 |
| 931145 | Mozzo Ruota Anteriore con Cuscinetto Skf / Front Wheel Hub with Skf Bearing | IVECO | 158 |
| 931172 | Mozzo Ruota Posteriore con Cuscinetti Skf / Rear Wheel Hub with Skf Bearings | IVECO | 159 |
| 931146 | Mozzo Ruota Anteriore con Colonnette / Front Wheel Hub with Bolts | IVECO | 162 |
| 931153 | Mozzo Ruota Anteriore / Front Wheel Hub | MAN | 169 |
| 931156 | Mozzo Ruota Anteriore / Front Wheel Hub | MAN | 169 |
| 931154 | Mozzo Ruota Posteriore / Rear Wheel Hub | MAN | 171 |
| 931155 | Mozzo Ruota Posteriore / Rear Wheel Hub | MAN | 171 |
| 931810 | Mozzo Ruota Anteriore con Cuscinetto Skf / Front Wheel Hub with Skf Bearing | MERCEDES | 173 |
| 931807 | Mozzo Ruota Posteriore / Rear Wheel Hub | MERCEDES | 175 |
| 931868 | Mozzo Ruota Posteriore / Rear Wheel Hub | MERCEDES | 175 |
| 931836 | Mozzo Ruota Posteriore / Rear Wheel Hub | MERCEDES | 176 |
| 931422 | Mozzo Ruota Anteriore con Cuscinetto e Abs / Front Wheel Hub with Bearing and Abs | RENAULT | 181 |
| 931471 | Mozzo Ruota Posteriore con Cuscinetti Fag e Abs / Rear Wheel Hub with Fag Bearings and Abs | RENAULT-VOLVO | 181-215 |
| 931486 | Mozzo Ruota Posteriore con Cuscinetti Fag e Abs / Rear Wheel Hub with Fag Bearings and Abs | RENAULT-VOLVO | 182-215 |
| 931107 | Mozzo Ruota Posteriore con Cuscinetti / Rear Wheel Hub with Bearings | RENAULT-VOLVO | 183-217 |
| 931472 | Mozzo Ruota Posteriore con Cuscinetti Fag e Abs / Rear Wheel Hub with Fag Bearings and Abs | RENAULT-VOLVO | 183-217 |
| 931521 | Mozzo Ruota con Cuscinetti Skf e Calotta OE / Wheel Hub with Skf Bearings and OE Cover | ROR | 184 |
| 931522 | Mozzo Ruota con Cuscinetti Skf e Calotta OE / Wheel Hub with Skf Bearings and OE Cover | ROR | 185 |
| 931525 | Mozzo Ruota con Cuscinetti Skf e Calotta OE / Wheel Hub with Skf Bearings and OE Cover | ROR | 186 |
| 931526 | Mozzo Ruota con Cuscinetti Skf e Calotta OE / Wheel Hub with Skf Bearings and OE Cover | ROR | 187 |
| 931523 | Mozzo Ruota con Cuscinetti Skf e Calotta OE / Wheel Hub with Skf Bearings and OE Cover | ROR | 188 |
| 931524 | Mozzo Ruota con Cuscinetti Skf e Calotta OE / Wheel Hub with Skf Bearings and OE Cover | ROR | 189 |
| 931528 | Mozzo Ruota con Cuscinetti Skf e Calotta OE / Wheel Hub with Skf Bearings and OE Cover | ROR | 190 |
| 931530 | Mozzo Ruota con Cuscinetti e Calotta / Wheel Hub with Bearings and Cover | ROR | 191 |
| 931530/N | Mozzo Ruota / Wheel Hub | ROR | 191 |
| 931531 | Mozzo Ruota con Cuscinetti FAG e Calotta OE / Wheel Hub with FAG Bearings and OE Cover | ROR | 191 |
| 931532 | Mozzo Ruota con Cuscinetti Skf e Calotta OE / Wheel Hub with Skf Bearings and OE Cover | ROR | 192 |
| 931527 | Mozzo Ruota con Cuscinetti Skf e Calotta OE / Wheel Hub with Skf Bearings and OE Cover | ROR | 193 |
| 931616 | Mozzo Ruota con Cuscinetti Skf e Calotta OE / Wheel Hub with Skf Bearings and OE Cover | SAF | 195 |
| 931630 | Mozzo Ruota con Cuscinetti Fag, Abs e Calotta / Wheel Hub with Fag Bearings, Abs and Cover | SAF | 196 |
| 931631 | Mozzo Ruota con Cuscinetti Fag, Abs e Calotta / Wheel Hub with Fag Bearings, Abs and Cover | SAF | 196 |
| 931633 | Mozzo Ruota con Cuscinetti Fag, Abs e Calotta / Wheel Hub with Fag Bearings, Abs and Cover | SAF | 197 |
| 931632 | Mozzo Ruota con Cuscinetti Fag, Abs e Calotta / Wheel Hub with Fag Bearings, Abs and Cover | SAF | 198 |
| 931635 | Mozzo Ruota con Cuscinetti Fag, Abs e Calotta / Wheel Hub with Fag Bearings, Abs and Cover | SAF | 199 |
| 931634 | Mozzo Ruota con Cuscinetti Fag, Abs e Calotta / Wheel Hub with Fag Bearings, Abs and Cover | SAF | 200 |
| 931636 | Mozzo Ruota con Cuscinetti Fag, Abs e Calotta OE / Wheel Hub with Fag Bearings, Abs and OE Cover | SAF | 200 |
| 931637 | Mozzo Ruota con Cuscinetti Fag e Calotta / Wheel Hub with Fag Bearings and Cover | SAF | 201 |
| 931638 | Mozzo Ruota con Cuscinetti Fag, Abs e Calotta OE / Wheel Hub with Fag Bearings, Abs and OE Cover | SAF | 201 |
| 931869 | Mozzo Ruota con Cuscinetti e Calotta / Wheel Hub with Bearings and Cover | SAF | 201 |

NEWS

| Emmerre | Descrizione/Description | Adattabile/Adaptable to | Pagina/Page |
|---------------|---|-------------------------|----------------|
| 931870 | Mozzo Ruota con Cuscinetti e Calotta / Wheel Hub with Bearings and Cover | SAF | 201 |
| 931838 | Mozzo Ruota Anteriore con Cuscinetto Skf e Abs / Front Wheel Hub with Skf Bearing and Abs | SCANIA | 202 |
| 931843 | Mozzo Ruota Posteriore con Cuscinetto Skf / Rear Wheel Hub with Skf Bearing | SCANIA | 203 |
| 931839 | Mozzo Ruota Anteriore-Posteriore con Cuscinetto Skf / Front and Rear Wheel Hub with Bearing Skf | SCANIA | 204 |
| 931844 | Mozzo Ruota Posteriore con Cuscinetti Skf / Rear Wheel Hub with Skf Bearings | SCANIA | 205 |
| 931806 | Mozzo Ruota Anteriore / Front Wheel Hub | SCANIA | 206 |
| 931842 | Mozzo Ruota Anteriore con Cuscinetto / Front Wheel Hub with Bearing | SCANIA | 206 |
| 931847 | Mozzo Ruota Anteriore con Cuscinetto Skf / Front Wheel Hub with Skf Bearing | SCANIA | 206 |
| 931841 | Mozzo Ruota Posteriore con Cuscinetti Skf / Rear Wheel Hub with Skf Bearings | SCANIA | 207 |
| 931845 | Mozzo Ruota Posteriore / Rear Wheel Hub | SCANIA | 207 |
| 931846 | Mozzo Ruota Posteriore con Cuscinetti Skf / Rear Wheel Hub with Skf Bearings | SCANIA | 207 |
| 931621 | Mozzo Ruota / Wheel Hub | SMB | 209 |
| 931475 | Mozzo Ruota Posteriore con Cuscinetti Fag e Abs / Rear Wheel Hub with Fag Bearings and Abs | VOLVO | 216 |
| 931011 | Cuscinetto Mozzo Ruota / Brake Wheel Hub Bearing | BPW-DAF | 219-225 |
| 931099 | Cuscinetto Mozzo Ruota / Brake Wheel Hub Bearing | BPW-MAN | 219-241 |
| 931489 | Cuscinetto Mozzo Ruota / Brake Wheel Hub Bearing | BPW | 219 |
| 931388 | Kit Cuscinetti Mozzo Ruota / Brake Wheel Hub Bearings Kit | BPW | 220 |
| 931387 | Kit Cuscinetti Mozzo Ruota / Brake Wheel Hub Bearings Kit | BPW | 221 |
| 931389 | Kit Cuscinetti Mozzo Ruota / Brake Wheel Hub Bearings Kit | BPW | 221 |
| 931390 | Kit Cuscinetti Mozzo Ruota / Brake Wheel Hub Bearings Kit | BPW | 221 |
| 930996 | Cuscinetto Mozzo Ruota / Brake Wheel Hub Bearing | DAF-MAN | 225-240 |
| 931091 | Cuscinetto Mozzo Ruota / Brake Wheel Hub Bearing | DAF-MAN | 225-240 |
| 930994 | Cuscinetto Mozzo Ruota / Brake Wheel Hub Bearing | DAF-MERCEDES | 225-245 |
| 931083 | Cuscinetto Mozzo Ruota / Brake Wheel Hub Bearing | DAF-MAN | 226-241 |
| 931086 | Cuscinetto Mozzo Ruota / Brake Wheel Hub Bearing | DAF | 226 |
| 931394 | Cuscinetto Mozzo Ruota / Brake Wheel Hub Bearing | DAF-IVECO | 226-237 |
| 931609 | Kit Cuscinetti Mozzo Ruota / Brake Wheel Hub Bearings Kit | DAF | 226 |
| 931162 | Cuscinetto Mozzo Ruota / Brake Wheel Hub Bearing | DAF-IVECO | 227-236 |
| 931378 | Cuscinetto Mozzo Ruota / Brake Wheel Hub Bearing | DAF-MAN | 227-242 |
| 931160 | Cuscinetto Mozzo Ruota Posteriore / Rear Brake Wheel Hub Bearing | IVECO | 231 |
| 931174 | Cuscinetto Mozzo Ruota Posteriore / Rear Brake Wheel Hub Bearing | IVECO | 237 |
| 931488 | Cuscinetto Mozzo Ruota Iveco con Sensore Magnetico / Brake Wheel Hub Bearing with Magnetic Sensor | IVECO | 237 |
| 931087 | Cuscinetto Mozzo Ruota / Brake Wheel Hub Bearing | MAN-MERCEDES | 240-246 |
| 931108 | Cuscinetto Mozzo Ruota / Brake Wheel Hub Bearing | MAN-MERCEDES | 241-247 |
| 931380 | Cuscinetto Mozzo Ruota / Brake Wheel Hub Bearing | MAN-MERCEDES | 242-247 |
| 931979 | Cuscinetto Mozzo Ruota / Brake Wheel Hub Bearing | MAN-MERCEDES | 242-248 |
| 930995 | Cuscinetto Mozzo Ruota / Brake Wheel Hub Bearing | MERCEDES | 245 |
| 931056 | Cuscinetto Mozzo Ruota / Brake Wheel Hub Bearing | MERCEDES-RENAULT | 246-252 |
| 931089 | Cuscinetto Mozzo Ruota / Brake Wheel Hub Bearing | MERCEDES | 246 |
| 931397 | Cuscinetto Mozzo Ruota / Brake Wheel Hub Bearing | MERCEDES | 247 |
| 931053 | Cuscinetto Mozzo Ruota / Brake Wheel Hub Bearing | RENAULT | 252 |
| 931812 | Cuscinetto Mozzo Ruota / Brake Wheel Hub Bearing | RENAULT-SAF | 253-261 |
| 931396 | Cuscinetto Mozzo Ruota / Brake Wheel Hub Bearing | ROR | 256 |
| 931420 | Cuscinetto Mozzo Ruota / Brake Wheel Hub Bearing | ROR | 257 |
| 931594 | Cuscinetto Mozzo Ruota / Brake Wheel Hub Bearing | SAF | 261 |
| 931012 | Cuscinetto Mozzo Ruota / Brake Wheel Hub Bearing | SCANIA | 264 |

| Emmerre | Descrizione/Description | Adattabile/Adaptable to | Pagina/Page |
|-----------------|--|-------------------------|----------------|
| 931061 | Kit Cuscinetti Mozzo Ruota / Brake Wheel Hub Bearings Kit | SCANIA | 264 |
| 931813 | Cuscinetto Mozzo Ruota / Brake Wheel Hub Bearing | VOLVO | 274 |
| 951120 | Colonna Disco Freno / Brake Disc Bolt | IVECO | 285 |
| 951130 | Colonna Disco Freno / Brake Disc Bolt | MAN | 288 |
| 951131 | Colonna Disco Freno / Brake Disc Bolt | MAN | 288 |
| 951140 | Colonna Disco Freno / Brake Disc Bolt | MERCEDES | 289 |
| 951141 | Colonna Disco Freno / Brake Disc Bolt | MERCEDES | 289 |
| 931827.1 | Colonna Disco Freno / Brake Disc Bolt | MERCEDES | 290 |
| 951073 | Dado Mozzo Ruota / Brake Wheel Hub Nut | RENAULT-VOLVO | 293-301 |
| 933119 | Dado Mozzo Ruota / Brake Wheel Hub Nut | ROR-SAF | 294-295 |
| 933140 | Colonna Ruota / Brake Wheel Hub Bolt | ROR | 294 |
| 951100 | Colonna Disco Freno / Brake Disc Bolt | SAF | 295 |
| 951150 | Kit Viti Disco Freno / Brake Disc Bolts Kit | SAF | 295 |
| 951151 | Kit Viti Disco Freno / Brake Disc Bolts Kit | SAF | 295 |
| 951089 | Colonna Mozzo Ruota Posteriore / Rear Brake Wheel Hub Bolt | SCANIA | 297 |
| 951090 | Colonna Mozzo Ruota Anteriore / Front Brake Wheel Hub Bolt | SCANIA | 298 |
| 951072 | Dado Mozzo Ruota con Rondella / Brake Wheel Hub Nut with Washer | VOLVO | 301 |
| 101589 | Anello Scorrimento Mozzo Ruota / Sliding Ring For Wheel Hub | MERCEDES | 323 |
| 101590 | Anello Paraolio Per Mozzo Ruota Nbr / Brake Wheel Hub Oil Seal Nbr | SMB | 331 |
| 961368 | Sensore Abs con Boccola e Grasso / Abs Sensor with Bush and Grease | DAF | 337 |
| 961318 | Sensore Abs con Boccola e Grasso / Abs Sensor with Bush and Grease | DAF-SAF | 337-353 |
| 961366 | Sensore Abs con Boccola e Grasso / Abs Sensor with Bush and Grease | DAF-IVECO | 338-342 |
| 961367 | Sensore Abs con Boccola e Grasso / Abs Sensor with Bush and Grease | DAF-IVECO | 338-341 |
| 961362 | Sensore Abs / Abs Sensor | IVECO | 339 |
| 961363 | Sensore Abs / Abs Sensor | IVECO | 339 |
| 961377 | Sensore Abs con Boccola e Grasso / Abs Sensor with Bush and Grease | IVECO | 341 |
| 961378 | Sensore Abs con Boccola e Grasso / Abs Sensor with Bush and Grease | IVECO | 341 |
| 961383 | Sensore Abs con Boccola e Grasso / Abs Sensor with Bush and Grease | MAN | 344 |
| 961387 | Sensore Abs con Boccola e Grasso / Abs Sensor with Bush and Grease | MAN | 344 |
| 961393 | Sensore Abs con Boccola e Grasso / Abs Sensor with Bush and Grease | MAN-MERCEDES | 344-347 |
| 961384 | Sensore Abs con Boccola e Grasso / Abs Sensor with Bush and Grease | MAN | 345 |
| 961390 | Sensore Abs con Boccola e Grasso / Abs Sensor with Bush and Grease | MAN | 345 |
| 961391 | Sensore Abs con Boccola e Grasso / Abs Sensor with Bush and Grease | MAN | 345 |
| 961386 | Sensore Abs con Boccola e Grasso / Abs Sensor with Bush and Grease | MAN | 346 |
| 961389 | Sensore Abs con Boccola e Grasso / Abs Sensor with Bush and Grease | MAN | 346 |
| 961392 | Sensore Abs con Boccola e Grasso / Abs Sensor with Bush and Grease | MERCEDES | 347 |
| 961395 | Sensore Abs con Boccola e Grasso / Abs Sensor with Bush and Grease | MERCEDES | 348 |
| 961396 | Sensore Abs con Boccola e Grasso / Abs Sensor with Bush and Grease | MERCEDES | 348 |
| 961397 | Sensore Abs con Boccola e Grasso / Abs Sensor with Bush and Grease | MERCEDES | 348 |
| 961398 | Sensore Abs con Boccola e Grasso / Abs Sensor with Bush and Grease | MERCEDES | 348 |
| 961399 | Sensore Abs con Boccola e Grasso / Abs Sensor with Bush and Grease | MERCEDES | 349 |
| 961311 | Sensore Abs con Boccola e Grasso / Abs Sensor with Bush and Grease | RENAULT-VOLVO | 350-359 |
| 961312 | Sensore Abs con Boccola e Grasso / Abs Sensor with Bush and Grease | RENAULT-VOLVO | 350-357 |
| 961310 | Sensore Abs con Boccola e Grasso / Abs Sensor with Bush and Grease | RENAULT-VOLVO | 351-358 |
| 961313 | Sensore Abs con Boccola e Grasso / Abs Sensor with Bush and Grease | RENAULT-VOLVO | 351-357 |
| 961370 | Sensore Abs con Boccola e Grasso / Abs Sensor with Bush and Grease | SAF | 353 |
| 961371 | Sensore Abs con Boccola e Grasso / Abs Sensor with Bush and Grease | SAF-SCHMITZ | 353-356 |











NEWS

| Emmerre | Descrizione/Description | Adattabile/Adaptable to | Pagina/Page |
|-----------------|--|-------------------------|----------------|
| 961322 | Sensore Abs Con Boccola e Grasso / Abs Sensor with Bush and Grease | SCANIA | 354 |
| 961323 | Sensore Abs Con Boccola e Grasso / Abs Sensor with Bush and Grease | SCANIA | 354 |
| 961330 | Sensore Abs Con Boccola e Grasso / Abs Sensor with Bush and Grease | VOLVO | 357 |
| 961328 | Sensore Abs Con Boccola e Grasso / Abs Sensor with Bush and Grease | VOLVO | 358 |
| 961329 | Sensore Abs Con Boccola e Grasso / Abs Sensor with Bush and Grease | VOLVO | 358 |
| 930935 | Calotta Mozzo Ruota / Brake Wheel Hub Cover | BPW | 361 |
| 930943 | Anello Abs Mozzo Ruota / Brake Wheel Hub Abs Ring | BPW | 361 |
| 930944 | Anello Abs Mozzo Ruota / Brake Wheel Hub Abs Ring | BPW | 361 |
| 930962 | Anello Abs Mozzo Ruota / Brake Wheel Hub Abs Ring | BPW | 361 |
| 930936 | Calotta Mozzo Ruota / Brake Wheel Hub Cover | BPW | 362 |
| 930937 | Calotta Mozzo Ruota / Brake Wheel Hub Cover | BPW | 362 |
| 930938 | Calotta Mozzo Ruota / Brake Wheel Hub Cover | BPW | 362 |
| 930939 | Calotta Mozzo Ruota / Brake Wheel Hub Cover | BPW | 362 |
| 930960 | Anello Abs Mozzo Ruota / Brake Wheel Hub Abs Ring | BPW | 363 |
| 930961 | Anello Abs Mozzo Ruota / Brake Wheel Hub Abs Ring | BPW | 363 |
| 931114 | Anello Abs Mozzo Ruota / Brake Wheel Hub Abs Ring | BPW | 363 |
| 931147 | Anello Abs Mozzo Ruota / Brake Wheel Hub Abs Ring | DAF | 365 |
| 931750.3 | Calotta Mozzo Ruota / Brake Wheel Hub Cover | DAF | 365 |
| 930967 | Anello Abs Mozzo Ruota / Brake Wheel Hub Abs Ring | IVECO | 370 |
| 930968 | Anello Abs Mozzo Ruota / Brake Wheel Hub Abs Ring | IVECO | 370 |
| 930971 | Anello Abs Mozzo Ruota Magnetico / Magnetic Brake Wheel Hub Abs Ring | IVECO | 370 |
| 931157 | Anello Abs Mozzo Ruota / Brake Wheel Hub Abs Ring | MAN | 371 |
| 931158 | Anello Abs Mozzo Ruota / Brake Wheel Hub Abs Ring | MAN-MERCEDES | 371-373 |
| 931136 | Anello Abs Mozzo Ruota / Brake Wheel Hub Abs Ring | MERCEDES | 373 |
| 931148 | Calotta Mozzo Ruota / Brake Wheel Hub Cover | MERCEDES | 373 |
| 931534 | Calotta Mozzo Ruota / Brake Wheel Hub Cover | ROR | 375 |
| 931535 | Calotta Mozzo Ruota / Brake Wheel Hub Cover | ROR | 375 |
| 931536 | Calotta Mozzo Ruota / Brake Wheel Hub Cover | ROR | 375 |
| 931537 | Calotta Mozzo Ruota / Brake Wheel Hub Cover | ROR | 375 |
| 931159 | Anello Abs Mozzo Ruota / Brake Wheel Hub Abs Ring | SAF | 376 |
| 931161 | Anello Abs Mozzo Ruota / Brake Wheel Hub Abs Ring | SAF | 376 |
| 931607 | Calotta Mozzo Ruota / Brake Wheel Hub Cover | SAF | 376 |
| 931624 | Calotta Mozzo Ruota / Brake Wheel Hub Cover | SAF | 376 |
| 931622 | Calotta Mozzo Ruota / Brake Wheel Hub Cover | SAF | 377 |
| 931623 | Calotta Mozzo Ruota / Brake Wheel Hub Cover | SAF | 377 |
| 931625 | Calotta Mozzo Ruota / Brake Wheel Hub Cover | SAF | 377 |
| 931149 | Anello Abs Mozzo Ruota / Brake Wheel Hub Abs Ring | SAF | 378 |
| 931152 | Anello Abs Mozzo Ruota / Brake Wheel Hub Abs Ring | SAF | 378 |
| 931180 | Dado Mozzo Ruota / Brake Wheel Hub Nut | SAF | 378 |
| 931181 | Dado Mozzo Ruota / Brake Wheel Hub Nut | SAF | 379 |
| 931163 | Anello Abs Mozzo Ruota / Brake Wheel Hub Abs Ring | SCANIA | 380 |
| 931164 | Anello Abs Mozzo Ruota / Brake Wheel Hub Abs Ring | SCANIA | 380 |
| 931165 | Anello Abs Mozzo Ruota / Brake Wheel Hub Abs Ring | SCANIA | 380 |
| 931626 | Calotta Mozzo Ruota / Brake Wheel Hub Cover | SCANIA | 381 |





MOZZI RUOTA
WHEEL HUBS
MOYEURS DE ROUE
RADNABEN
СТУПИЦЫ КОЛЕС
BUJES DE RUEDA

EMMERRE
spare parts for trucks and trailers

BPW

| Applicazioni / Applications | Dettagli / Detail | Adattabile a / Adaptable to | Emmerre |
|--|--|-----------------------------|---------------|
| Axle Eco Plus H 8/9 ton SKHS SKHZ | - Mozzo Ruota Technobrake/ <i>Technobrake wheel hub</i> - Senza cuscinetti/ <i>Without bearings</i> | 0327243102 0327243100 | 931406 |
|  | | | |
| Connessione / Connected:  931074-931395 | | | |
| Axle Eco Plus H 8/9 ton SKHS SKHZ | - Mozzo Ruota Technobrake/ <i>Technobrake wheel hub</i> - Con cuscinetti/ <i>With bearings</i> - Con calotta/ <i>With cover</i> - Con ABS/ <i>With ABS</i> | 0980106070 | 931408 |
|  | | | |
| Connessione / Connected:  931074-931395  931131  101544  930935 | | | |
| Axle Eco Plus H 8/9 ton SKHS SKHZ | - Mozzo Ruota Technobrake/ <i>Technobrake wheel hub</i> - Con cuscinetti SKF/<i>With SKF bearings</i> - Con calotta O.E./<i>With O.E. cover</i> - Con ABS/ <i>With ABS</i> | 0980106070 | 931458 |
|  | | | |
| Connessione / Connected:  931131  101544 | | | |







Mozzi Ruota
Wheel Hubs







| Emmerre | Adattabile a / Adaptable to | Dettagli / Detail | Applicazioni / Applications |
|--|--|---|--|
| 931401  | 0327230410 0327230620 0327230350 8241999457 | <ul style="list-style-type: none"> - Mozzo Ruota Technobrake/ <i>Technobrake wheel hub</i> - Senza cuscinetti/<i>Without bearings</i> | Axle H-R 8-9 ton Kassbohrer |
| Connessione / Connected:  | | | 931394-931396 |
| 931410   | 0327230410 0327230620 0327230350 8241999457 | <ul style="list-style-type: none"> - Mozzo Ruota Technobrake/ <i>Technobrake wheel hub</i> - Con cuscinetti/<i>With bearings</i> - Con calotta/<i>With cover</i> | Axle H-R 8-9 ton Kassbohrer |
| Connessione / Connected:  | | | 931394-931396 |
| | | |  930936 |
| 931464    | 0327230410 0327230620 0327230350 8241999457 | <ul style="list-style-type: none"> - Mozzo Ruota Technobrake/ <i>Technobrake wheel hub</i> - <u>Con cuscinetti SKF/With SKF bearings</u> - <u>Con calotta O.E./With O.E. cover</u> | Axle H-R 8-9 ton Kassbohrer |

MOZZI RUOTA
WHEEL HUBS
MOYEURS DE ROUE
RADNABEN
СТУПИЦЫ КОЛЕС
BUJES DE RUEDA

EMMERRE
spare parts for trucks and trailers

BPW



| Applicazioni / Applications | Dettagli / Detail | Adattabile a / Adaptable to | Emmerre |
|---|--|-----------------------------|---------------|
| Axle Eco Maxx 8/9 ton HSF HZF Axle Eco Maxx 8010 SK | - Mozzo Ruota Technobrake/ <i>Technobrake wheel hub</i> - Senza cuscinetti/ <i>Without bearings</i> | 0327230970 0327230950 | 931411 |
|  | | | |
| Connessione / Connected:  931394-931396 | | | |
| Axle Eco Maxx 8/9 ton HSF HZF Axle Eco Maxx 8010 SK | - Mozzo Ruota Technobrake/ <i>Technobrake wheel hub</i> - Con cuscinetti/ <i>With bearings</i> - Con calotta/ <i>With cover</i> | 0980106050 | 931402 |
|  | | | |
| Connessione / Connected:  931394-931396  930937 | | | |
| Axle Eco Maxx 8/9 ton HSF HZF Axle Eco Maxx 8010 SK | - Mozzo Ruota Technobrake/ <i>Technobrake wheel hub</i> - Con cuscinetti SKF/<i>With SKF bearings</i> - Con calotta O.E./<i>With O.E. cover</i> | 0980106050 | 931459 |
|  | | | |

| Emmerre | Adattabile a / Adaptable to | Dettagli / Detail | Applicazioni / Applications |
|--|-----------------------------|--|----------------------------------|
| 931412 | 0327243142 0327243140 | - Mozzo Ruota Technobrake/ <i>Technobrake wheel hub</i> - Senza cuscinetti/ <i>Without bearings</i> | Axle Eco Plus 8/9 ton SKHB |
| Connessione / Connected:  931074-931395 | | | |
| 931403 | 0980106580 | - Mozzo Ruota Technobrake/ <i>Technobrake wheel hub</i> - Con cuscinetti/ <i>With bearings</i> - Con ABS/ <i>With ABS</i> - Con calotta/ <i>With cover</i> | Axle Eco Plus 8/9 ton SKHB |
| Connessione / Connected:  931074-931395  930935  931131  101544 | | | |
| 931460 | 0980106580 | - Mozzo Ruota Technobrake/ <i>Technobrake wheel hub</i> - Con cuscinetti SKF/<i>With SKF bearings</i> - Con calotta O.E./<i>With O.E. cover</i> - Con ABS/ <i>With ABS</i> | Axle Eco Plus 8/9 ton SKHB |
| Connessione / Connected:  931131  101544 | | | |

MOZZI RUOTA
WHEEL HUBS
MOYEURS DE ROUE
RADNABEN
СТУПИЦЫ КОЛЕС
BUJES DE RUEDA

EMMERRE
spare parts for trucks and trailers

BPW

| Applicazioni / Applications | Dettagli / Detail | Adattabile a / Adaptable to | Emmerre |
|---|--|-----------------------------|---------------|
| Axle Eco 8/9 ton HS HZ | - Mozzo Ruota Technobrake/ <i>Technobrake wheel hub</i> - Senza cuscinetti/ <i>Without bearings</i> | 0327230870 0327230810 | 931413 |
|  | | | |
| Connessione / Connected:  931394-931396 | | | |
| Axle Eco 8/9 ton HS HZ | - Mozzo Ruota Technobrake/ <i>Technobrake wheel hub</i> - Con cuscinetti/ <i>With bearings</i> - Con calotta/ <i>With cover</i> | 0980106030 | 931404 |
|  | | | |
| Connessione / Connected:  931394-931396  930937 | | | |
| Axle Eco 8/9 ton HS HZ | - Mozzo Ruota Technobrake/ <i>Technobrake wheel hub</i> - Con cuscinetti SKF/<i>With SKF bearings</i> - Con calotta O.E./<i>With O.E. cover</i> | 0980106030 | 931461 |
|  | | | |









Mozzi Ruota
Wheel Hubs

EMMERRE

spare parts for trucks and trailers

BPW







MOZZI RUOTA
WHEEL HUBS
MOYEURS DE ROUE
RADNABEN
СТУПИЦЫ КОЛЕС
BUJES DE RUEDA

| Emmerre | Adattabile a / Adaptable to | Dettagli / Detail | Applicazioni / Applications |
|---|--|--|-----------------------------|
| 931414  | 0327244240 0327244220 0327244210 0327244300 | - Mozzo Ruota Technobrake/ <i>Technobrake wheel hub</i> - Senza cuscinetti/ <i>Without bearings</i> | Axle 9 ton KH HR |
| Connessione / Connected:  931074-931395 | | | |
| 931418   | 0327244240 0327244220 0327244210 0327244300 | - Mozzo Ruota Technobrake/ <i>Technobrake wheel hub</i> - Con cuscinetti/ <i>With bearings</i> - Con calotta/ <i>With cover</i> | Axle 9 ton KH HR |
| Connessione / Connected:  931074-931395  930938 | | | |
| 931375   | 0327244240 0327244220 0327244210 0327244300 | - Mozzo Ruota Technobrake/ <i>Technobrake wheel hub</i> - Con cuscinetti SKF/With SKF bearings - Con calotta O.E./With O.E. cover | Axle 9 ton KH/HR |

MOZZI RUOTA
WHEEL HUBS
MOYEURS DE ROUE
RADNABEN
СТУПИЦЫ КОЛЕС
BUJES DE RUEDA

EMMERRE
spare parts for trucks and trailers

BPW

| Applicazioni / Applications | Dettagli / Detail | Adattabile a / Adaptable to | Emmerre |
|---|--|-----------------------------|---------------|
| HS HZ Ecomaxx 12 ton | - Mozzo Ruota Technobrake/ <i>Technobrake wheel hub</i> - Senza cuscinetti/ <i>Without bearings</i> | 0327248970 | 931415 |
|  | | | |
| Connessione / Connected:  931074-931395 | | | |
| HS HZ Ecomaxx 12 ton | - Mozzo Ruota Technobrake/ <i>Technobrake wheel hub</i> - Con cuscinetti/ <i>With bearings</i> - Con calotta/ <i>With cover</i> | 0980106060 | 931405 |
|  | | | |
| Connessione / Connected:  931074-931395  930935 | | | |
| Assale HS/HZ Eco Maxx 12 ton | - Mozzo Ruota Technobrake/ <i>Technobrake wheel hub</i> - Con cuscinetti SKF/<i>With SKF bearings</i> - Con calotta O.E./<i>With O.E. cover</i> | 0980106060 | 931376 |
|  | | | |

Mozzi Ruota
Wheel Hubs















| Emmerre | Adattabile a / Adaptable to | Dettagli / Detail | Applicazioni / Applications |
|---|--|--|-----------------------------|
| 931400  | 0327248460 0327248400 0327248450 0327248390 0327248620 | - Mozzo Ruota Technobrake/ <i>Technobrake wheel hub</i> - Senza cuscinetti/ <i>Without bearings</i> | Axle H-R 12 ton |
| Connessione / Connected:  931074-931395 | | | |
| 931409   | 0327248460 0327248400 0327248450 0327248390 0327248620 | - Mozzo Ruota Technobrake/ <i>Technobrake wheel hub</i> - Con cuscinetti/ <i>With bearings</i> - Con calotta/ <i>With cover</i> | Axle H-R 12 ton |
| Connessione / Connected:  931074-931395  930938 | | | |
| 931377   | 0327248460 0327248400 0327248450 0327248390 0327248620 | - Mozzo Ruota Technobrake/ <i>Technobrake wheel hub</i> - <u>Con cuscinetti SKF/With SKF bearings</u> - <u>Con calotta O.E./With O.E. cover</u> | Assale H/R 12 ton |

MOZZI RUOTA
WHEEL HUBS
MOYEURS DE ROUE
RADNABEN
СТУПИЦЫ КОЛЕС
BUJES DE RUEDA

EMMERRE
spare parts for trucks and trailers

BPW

| Applicazioni / Applications | Dettagli / Detail | Adattabile a / Adaptable to | Emmerre |
|--|--|-----------------------------|---------------|
| Axle Eco Plus 2 8/9 ton HS HZ | - Mozzo Ruota Technobrake/ <i>Technobrake wheel hub</i> - Senza cuscinetti/ <i>Without bearings</i> - Con calotta/ <i>With cover</i> | 0327243280 | 931421 |
|  | | | |
| Connessione / Connected:  931074-931395 | | | |
| Axle Eco Plus 2 8/9 ton HS HZ | - Mozzo Ruota Technobrake/ <i>Technobrake wheel hub</i> - Con cuscinetti/ <i>With bearings</i> - Con ABS/ <i>With ABS</i> - Con calotta/ <i>With cover</i> | 0980107320 | 931398 |
|  | | | |
| Connessione / Connected:  931074-931395  930935  931131  101544 | | | |
| Axle Eco Plus 2 8/9 ton HS/HZ | - Mozzo Ruota Technobrake/ <i>Technobrake wheel hub</i> - Con cuscinetti SKF/<i>With SKF bearings</i> - Con calotta O.E./<i>With O.E. cover</i> - Con ABS/ <i>With ABS</i> | 0980107320 | 931463 |
|   | | | |
| Connessione / Connected:  931131  101544 | | | |

| Emmerre | Adattabile a / Adaptable to | Dettagli / Detail | Applicazioni / Applications |
|--|-----------------------------|--|-----------------------------|
| 931434   | 0327243290 | <ul style="list-style-type: none"> - Mozzo Ruota Technobrake/ <i>Technobrake wheel hub</i> - Senza cuscinetti/<i>Without bearings</i> - Con calotta/<i>With cover</i> | Axle Eco Plus 2 HS HZ |
| Connessione / Connected:  931074-931395 | | | |
| 931437   | 0980107350 | <ul style="list-style-type: none"> - Mozzo Ruota Technobrake/ <i>Technobrake wheel hub</i> - Con cuscinetti/<i>With bearings</i> - Con ABS/<i>With ABS</i> - Con calotta/<i>With cover</i> | Axle Eco Plus 2 HS HZ |
| Connessione / Connected:  931074-931395  930935  931131  101544 | | | |
| 931381    | 0980107350 | <ul style="list-style-type: none"> - Mozzo Ruota Technobrake/ <i>Technobrake wheel hub</i> - <u>Con cuscinetti SKF/<i>With SKF bearings</i></u> - <u>Con calotta O.E./<i>With O.E. cover</i></u> - Con ABS/<i>With ABS</i> | Axle Eco Plus 2 HS HZ |
| Connessione / Connected:  931131  101544 | | | |









MOZZI RUOTA
WHEEL HUBS
MOYEURS DE ROUE
RADNABEN
СТУПИЦЫ КОЛЕС
BUJES DE RUEDA

EMMERRE
spare parts for trucks and trailers

BPW

| Applicazioni / Applications | Dettagli / Detail | Adattabile a / Adaptable to | Emmerre |
|---|--|-----------------------------|---------------|
| Axle Eco Plus 3 | - Mozzo Ruota Technobrake/ <i>Technobrake wheel hub</i> - Senza cuscinetti/ <i>Without bearings</i> | 0327243410 | 931373 |
|  | | | |
| Connessione / Connected:  931074-931395 | | | |
| Axle Eco Plus 3 | - Mozzo Ruota Technobrake/ <i>Technobrake wheel hub</i> - Con cuscinetti/ <i>With bearings</i> - Con calotta/ <i>With cover</i> | 0980108360 | 931399 |
|  | | | |
| Connessione / Connected:  931074-931395  930939 | | | |
| Axle Eco Plus 3 | - Mozzo Ruota Technobrake/ <i>Technobrake wheel hub</i> - Con cuscinetti SKF/<i>With SKF bearings</i> - Con calotta O.E./<i>With O.E. cover</i> | 0980108360 | 931462 |
|  | | | |

Mozzi Ruota
Wheel Hubs













| Emmerre | Adattabile a / Adaptable to | Dettagli / Detail | Applicazioni / Applications |
|--|-----------------------------|--|--|
| 931369  | 0327232030 | <ul style="list-style-type: none"> - Mozzo Ruota Technobrake/ <i>Technobrake wheel hub</i> - Senza cuscinetti/<i>Without bearings</i> - Con ABS/<i>With ABS</i> | Axle Eco Maxx 8/9 ton HSF HZF Axle Eco Maxx 8010 SK |
| Connessione / Connected:  931394-931396 | | | |
| 931393  | 0980106640 | <ul style="list-style-type: none"> - Mozzo Ruota Technobrake/ <i>Technobrake wheel hub</i> - Con cuscinetti/<i>With bearings</i> - Con ABS/<i>With ABS</i> - Con calotta/<i>With cover</i> | Axle Eco Maxx 8/9 ton HSF HZF Axle Eco Maxx 8010 SK |
| Connessione / Connected:  931394-931396  931114  930937 | | | |
| 931465  | 0980106640 | <ul style="list-style-type: none"> - Mozzo Ruota Technobrake/ <i>Technobrake wheel hub</i> - <u>Con cuscinetti SKF/<i>With SKF bearings</i></u> - <u>Con calotta O.E./<i>With O.E. cover</i></u> - Con ABS/<i>With ABS</i> | Axle Eco Maxx 8/9 ton HSF HZF Axle Eco Maxx 8010 SK |
| Connessione / Connected:  931114 | | | |

MOZZI RUOTA
WHEEL HUBS
MOYEURS DE ROUE
RADNABEN
СТУПИЦЫ КОЛЕС
BUJES DE RUEDA

EMMERRE
spare parts for trucks and trailers

BPW

| Applicazioni / Applications | Dettagli / Detail | Adattabile a / Adaptable to | Emmerre |
|---|--|-----------------------------|---------------|
| Axle Eco Plus 3 RS | - Mozzo Ruota Technobrake/ <i>Technobrake wheel hub</i> - Senza cuscinetti/ <i>Without bearings</i> | 0327243420 | 931382 |
|  | | | |
| Connessione / Connected:  931074-931395 | | | |
| Axle Eco Plus 3 RS | - Mozzo Ruota Technobrake/ <i>Technobrake wheel hub</i> - Con cuscinetti/ <i>With bearings</i> - Con calotta/ <i>With cover</i> | 0980108390 | 931383 |
|  | | | |
| Connessione / Connected:  931074-931395  930939 | | | |
| Axle Eco Plus 3 RS | - Mozzo Ruota Technobrake/ <i>Technobrake wheel hub</i> - Con cuscinetti SKF/With SKF bearings - Con calotta O.E./With O.E. cover | 0980108390 | 931492 |
|  | | | |

| Emmerre | Adattabile a / Adaptable to | Dettagli / Detail | Applicazioni / Applications |
|--|-----------------------------|--|-----------------------------|
| 931386  | 0327243232 | - Mozzo Ruota Technobrake/ <i>Technobrake wheel hub</i> - Senza cuscinetti/ <i>Without bearings</i> | Axle Eco Seal H |
| Connessione / Connected:  931074-931395 | | | |
| 931392   | 0980106082 | - Mozzo Ruota Technobrake/ <i>Technobrake wheel hub</i> - Con cuscinetti/ <i>With bearings</i> - Con ABS/ <i>With ABS</i> - Con calotta/ <i>With cover</i> | Axle Eco Seal H |
| Connessione / Connected:  931074-931395  930935  930960  101544 | | | |
| 931374   | 0980106082 | - Mozzo Ruota Technobrake/ <i>Technobrake wheel hub</i> - Con cuscinetti SKF/<i>With SKF bearings</i> - Con calotta O.E./<i>With O.E. cover</i> - Con ABS/ <i>With ABS</i> | Axle Eco Seal H |
| Connessione / Connected:  930960  101544 | | | |

MOZZI RUOTA
WHEEL HUBS
MOYEURS DE ROUE
RADNABEN
СТУПИЦЫ КОЛЕС
BUJES DE RUEDA

EMMERRE
spare parts for trucks and trailers

BPW

| Applicazioni / Applications | Dettagli / Detail | Adattabile a / Adaptable to | Emmerre |
|--|--|--|--|
| Axle NK.F Eco 8010 | - Mozzo Ruota Technobrake/ <i>Technobrake wheel hub</i> - Senza cuscinetti/ <i>Without bearings</i> | 0327227410 | 931372  |
| Connessione / Connected:  931394-931396 | | | |
| Axle NK.F Eco 8010 | - Mozzo Ruota Technobrake/ <i>Technobrake wheel hub</i> - Con cuscinetti/ <i>With bearings</i> - Con ABS/ <i>With ABS</i> - Con calotta/ <i>With cover</i> | 0980106500  | 931371  |
| Connessione / Connected:  931394-931396  930937  930962 | | | |
| Axle NK.F Eco 8010 | - Mozzo Ruota Technobrake/ <i>Technobrake wheel hub</i> - Con cuscinetti SKF/<i>With SKF bearings</i> - Con calotta O.E./<i>With O.E. cover</i> - Con ABS/ <i>With ABS</i> | 0980106500  | 931370  |
| Connessione / Connected:  930962 | | | |

| Emmerre | Adattabile a / Adaptable to | Dettagli / Detail | Applicazioni / Applications |
|--|-----------------------------|--|-----------------------------|
| 931481  | 0327227480 | - Mozzo Ruota Technobrake/ <i>Technobrake wheel hub</i> - Senza cuscinetti/ <i>Without bearings</i> | Axle NK.F Eco L 8010 |
| Connessione / Connected:  | | | 931394-931396 |
| 931482   | 0980106540 | - Mozzo Ruota Technobrake/ <i>Technobrake wheel hub</i> - Con cuscinetti/ <i>With bearings</i> - Con ABS/ <i>With ABS</i> - Con calotta/ <i>With cover</i> | Axle NK.F Eco L 8010 |
| Connessione / Connected:    | | | 931394-931396 930937 930962 |
| 931484   | 0980106540 | - Mozzo Ruota Technobrake/ <i>Technobrake wheel hub</i> - Con cuscinetti SKF/<i>With SKF bearings</i> - Con calotta O.E./<i>With O.E. cover</i> - Con ABS/ <i>With ABS</i> | Axle NK.F Eco L 8010 |
| Connessione / Connected:  | | | 930962 |

MOZZI RUOTA
WHEEL HUBS
MOYEURS DE ROUE
RADNABEN
СТУПИЦЫ КОЛЕС
BUJES DE RUEDA

EMMERRE
spare parts for trucks and trailers

BPW

| Applicazioni / Applications | Dettagli / Detail | Adattabile a / Adaptable to | Emmerre |
|--|--|-----------------------------|---------|
| Axle Eco M/K | <ul style="list-style-type: none"> - Mozzo Ruota Technobrake/ <i>Technobrake wheel hub</i> - Senza cuscinetti/<i>Without bearings</i> - Con ABS/<i>With ABS</i> | 0327244400 | 931385 |
|  | | | |
| Connessione / Connected:  931074-931395 | | | |
| Axle Eco M/K | <ul style="list-style-type: none"> - Mozzo Ruota Technobrake/ <i>Technobrake wheel hub</i> - Con cuscinetti/<i>With bearings</i> - Con ABS/<i>With ABS</i> - Con calotta/<i>With cover</i> | 0980106560 | 931391 |
|  | | | |
| Connessione / Connected:  931074-931395  930935  930961 | | | |
| Axle Eco M/K | <ul style="list-style-type: none"> - Mozzo Ruota Technobrake/ <i>Technobrake wheel hub</i> - Con cuscinetti SKF/<i>With SKF bearings</i> - Con calotta O.E./<i>With O.E. cover</i> - Con ABS/<i>With ABS</i> | 0980106560 | 931466 |
|  | | | |
| Connessione / Connected:  930961 | | | |
| Axle K/F 10008 | <ul style="list-style-type: none"> - Mozzo Ruota Technobrake/ <i>Technobrake wheel hub</i> - Senza cuscinetti/<i>Without bearings</i> | 0327246110 | 931483 |
|  | | | |

Mozzi Ruota
Wheel Hubs

| Emmerre | Adattabile a / <i>Adaptable to</i> | Dettagli / <i>Detail</i> | Applicazioni / <i>Applications</i> |
|---|------------------------------------|---|------------------------------------|
| 931485   | 0327227200 | - Mozzo Ruota Technobrake/ <i>Technobrake wheel hub</i> - Senza cuscinetti/ <i>Without bearings</i> | Axle N.F 6410 8/9 ton |
| 931480   | 0327246282 | - Mozzo Ruota Technobrake/ <i>Technobrake wheel hub</i> - Senza cuscinetti/ <i>Without bearings</i> | Axle HZF Eco P 8008 |
| 931479   | 0327246150 | - Mozzo Ruota Technobrake/ <i>Technobrake wheel hub</i> - Senza cuscinetti/ <i>Without bearings</i> | Axle KH.F Eco 10008 |
| 931200  | 59520004 | - Per freno ruota/ <i>For wheel hub</i> - mm. 180-200 - Ruote gemellate/ <i>Twin wheels</i> | Trucks |

MOZZI RUOTA
WHEEL HUBS
MOYEURS DE ROUE
RADNABEN
СТУПИЦЫ КОЛЕС
BUJES DE RUEDA

EMMERRE
spare parts for trucks and trailers

DAF

| Applicazioni / Applications | Dettagli / Detail | Adattabile a / Adaptable to | Emmerre |
|--|---|--|--|
| XF 95 95 XF Euro 3 | - Mozzo ruota anteriore/ <i>Front wheel hub</i> - Con cuscinetti/ <i>With bearings</i> - Con ABS/ <i>With ABS</i> - 1° Tipo/ <i>Type</i> | 1391615 1388905 1697346 | 931753     |
| Connessione / Connected:  960213  931093-951076  931123 | | | |
| XF95 95XF Euro 3 | - Mozzo ruota anteriore/ <i>Front wheel hub</i> - Con ABS/ <i>With ABS</i> - 1° Tipo/ <i>Type</i> - Con cuscinetti FAG/<i>With bearings FAG</i> | 1391615 1388905 1697346 | 931853     |
| Connessione / Connected:  960213  931123 | | | |
| CF XF Euro 3 Euro 5 | - Mozzo ruota anteriore/ <i>Front wheel hub</i> - Con cuscinetti/ <i>With bearings</i> - Con calotta/ <i>With cover</i> - Con ABS/ <i>With ABS</i> | 2019789 1818004 1699327 1691621 | 931750     |
| Connessione / Connected:  960213  931051-951076  931123 | | | |
| CF XF Euro 3 Euro 5 | - Mozzo ruota anteriore/ <i>Front wheel hub</i> - Con cuscinetti FAG/<i>With bearings FAG</i> - Con calotta/ <i>With cover</i> - Con ABS/ <i>With ABS</i> | 2019789 1818004 1699327 1691621 | 931850     |
| Connessione / Connected:  960213  931123 | | | |

| Emmerre | Adattabile a / Adaptable to | Dettagli / Detail | Applicazioni / Applications |
|--|--|--|--|
| 931755  | 2019833 1812160 1428396 1613331 | - Mozzo ruota anteriore/ <i>Front wheel hub</i> - Con cuscinetti/ <i>With bearings</i> - 1° e 2° assale - <i>Axle</i> - Con ABS/ <i>With ABS</i> | CF 75 / 85 XF 105 |
| | | Connessione / Connected:  960213  931077  931134 | |
| 931855  | 2019833 1812160 1428396 1613331 | - Mozzo ruota anteriore/ <i>Front wheel hub</i> - Con ABS/ <i>With ABS</i> - 1° e 2° assale - <i>Axle</i> - Con cuscinetti FAG/<i>With bearings FAG</i> | CF 75 / 85 XF 105 |
| | | Connessione / Connected:  931134  960213 | |
| 931754  | 1275024 1348432 0538444 | - Mozzo ruota posteriore/ <i>Rear wheel hub</i> - Con cuscinetti/ <i>With bearings</i> - Con ABS/ <i>With ABS</i> | 65/65 CF 75/75 CF 85/85 CF 95/95 XF |
| | | Connessione / Connected:  931147  931397-930996  951092 | |
| 931749  | 1275024 1348432 0538444 | - Mozzo ruota posteriore/ <i>Rear wheel hub</i> - Con cuscinetti FAG/<i>With bearings FAG</i> - Con ABS/ <i>With ABS</i> | 65/65 CF 75/75 CF 85/85 CF 95/95 XF |
| | | Connessione / Connected:  931147  951092 | |

MOZZI RUOTA
WHEEL HUBS
MOYEURS DE ROUE
RADNABEN
СТУПИЦЫ КОЛЕС
BUJES DE RUEDA

EMMERRE
spare parts for trucks and trailers

DAF



| Applicazioni / Applications | Dettagli / Detail | Adattabile a / Adaptable to | Emmerre |
|--|--|---|--|
| CF XF Euro 3 | - Mozzo ruota posteriore/Rear wheel hub - Con cuscinetti/With bearings - Con ABS/With ABS | 1818003 1956105 1388906 1391617 2019853 | 931751   EMMERRE MODIFICATION NEWS |
| Connessione / Connected:  960213  931052  951077  931127 | | | |
| CF XF Euro 3 | - Mozzo ruota posteriore/Rear wheel hub - Con ABS/With ABS - Con cuscinetti FAG/With bearings FAG | 1818003 1956105 1388906 1391617 2019853 | 931851   EMMERRE MODIFICATION NEWS |
| Connessione / Connected:  960213  931127 | | | |
| CF XF Euro 5 | - Mozzo ruota posteriore/Rear wheel hub - Con cuscinetti/With bearings - Con ABS/With ABS | 1812161 1956100 1657637 2019802 | 931752   EMMERRE MODIFICATION NEWS |
| Connessione / Connected:  960213  931052  931125 | | | |
| CF XF Euro 5 | - Mozzo ruota posteriore/Rear wheel hub - Con ABS/With ABS - Con cuscinetti FAG/With bearings FAG | 1812161 1956100 1657637 2019802 | 931852   EMMERRE MODIFICATION NEWS |
| Connessione / Connected:  960213  931125 | | | |

| Emmerre | Adattabile a / Adaptable to | Dettagli / Detail | Applicazioni / Applications |
|---|-----------------------------|---|-----------------------------|
| 931487  | 1400061 | - Mozzo ruota anteriore/ <i>Front wheel hub</i> - Con cuscinetti/ <i>With bearings</i> - Con ABS/ <i>With ABS</i> | 45 - LF45 LF55 |
| 931619  | 1359555 | - Senza cuscinetti / <i>Without bearings</i> | Trucks |













MOZZI RUOTA
WHEEL HUBS
MOYEURS DE ROUE
RADNABEN
СТУПИЦЫ КОЛЕС
BUJES DE RUEDA

EMMERRE
spare parts for trucks and trailers

FRUEHAUF

| Applicazioni / Applications | Dettagli / Detail | Adattabile a / Adaptable to | Emmerre |
|-----------------------------|--|---|---------------|
| Axles | - Mozzo Ruota / Wheel hub - Senza cuscinetti / Without bearings | 0018321C 6502795D | 931617 |
| | |  | |
| Axles | - Mozzo Ruota / Wheel hub - Senza cuscinetti / Without bearings | M006050 M007851 | 931618 |
| | |  | |
| Axles | - Mozzo Ruota / Wheel hub - Senza cuscinetti / Without bearings | AJB0038001 31225 AJA00381 AJB0038D ASL0710 CF1014228 | 931619 |
| | |  | |





Mozzi Ruota
Wheel Hubs









| Emmerre | Adattabile a / Adaptable to | Dettagli / Detail | Applicazioni / Applications |
|---|-----------------------------|---|--|
| 931005 | 93813627 | - Mozzo ruota anteriore/ <i>Front wheel hub</i> - Con cuscinetti/ <i>With bearings</i> - Con distanziale/ <i>With spacer</i> | New Daily 35.10 |
|  | | Connessione / Connected:  931009-931010  931512 | |
| 931003 | 93804574 | - Mozzo ruota anteriore/ <i>Front wheel hub</i> - Senza cuscinetti/ <i>Without bearings</i> | New Daily 35.10 |
|  | | Connessione / Connected:  931009-931010  931512 | |
| 931006 | 93813628 | - Mozzo ruota anteriore/ <i>Front wheel hub</i> - Con cuscinetti/ <i>With bearings</i> - Con distanziale/ <i>With spacer</i> | New Daily 45/49.10 Turbodaily 35/45/49.12 |
|  | | Connessione / Connected:  931011-931012  931510 | |
| 931007 | 7169265 7168256 | - Mozzo ruota posteriore/ <i>Rear wheel hub</i> - Senza cuscinetto/ <i>Without bearing</i> - Con colonnette/ <i>With bolts</i> | New Daily 35/49.12 35.8 35.10 |
|  | | Connessione / Connected:  931174  951060 | |

MOZZI RUOTA
WHEEL HUBS
MOYEURS DE ROUE
RADNABEN
СТУПИЦЫ КОЛЕС
BUJES DE RUEDA

EMMERRE
spare parts for trucks and trailers

IVECO

| Applicazioni / Applications | Dettagli / Detail | Adattabile a / Adaptable to | Emmerre |
|--|--|-----------------------------|---------------|
| New Daily 35/49.12 35.8 35.10 | - Mozzo ruota posteriore/Rear wheel hub - Con cuscinetto/With bearing - Con colonnette/With bolts | 7169265 7168256 | 931142 |
|  | | | |
| Connessione / Connected:  931174  951060 | | | |
| New Daily 35/49.12 35.8 35.10 | - Mozzo ruota posteriore/Rear wheel hub - Con cuscinetto SKF/With SKF bearing - Con colonnette/With bolts | 7169265 7168256 | 931139 |
|  | | | |
| Connessione / Connected:  951060 | | | |
| New Daily 49.10 Turbodaily 35/49/59.12 35/40/45/50/65C15 29L10/11/12/13/14 35/40/45/50/65 C14 35S12/13/14/15/16/17 | - Mozzo ruota posteriore/Rear wheel hub - Senza cuscinetto/Without bearing - Con colonnette/With bolts | 7180049 | 931008 |
|  | | | |
| Connessione / Connected:  931014  951063 | | | |
| New Daily 49.10 Turbodaily 35/49/59.12 35/40/45/50/65C15 29L10/11/12/13/14 35/40/45/50/65 C14 35S12/13/14/15/16/17 | - Mozzo ruota posteriore/Rear wheel hub - Con cuscinetto/With bearing - Con colonnette/With bolts | 7180049 | 931143 |
|  | | | |
| Connessione / Connected:  931014  951063 | | | |







| Emmerre | Adattabile a / Adaptable to | Dettagli / Detail | Applicazioni / Applications |
|--|-----------------------------|---|--|
| 931138  | 7180049 | - Mozzo ruota posteriore/ <i>Rear wheel hub</i> - Con cuscinetti SKF/With SKF bearings - Con colonnette/ <i>With bolts</i> | New Daily 49.10 Turbodaily 35/49/59.12 35/40/45/50/65C15 29L10/11/12/13/14 35/40/45/50/65 C14 35S12/13/14/15/16/17 |
| Connessione / Connected:  | | | 951063 |
| 931000  | 93824579 42470845 | - Mozzo ruota anteriore/ <i>Front wheel hub</i> - Con cuscinetto/ <i>With bearing</i> | Daily City 2000 35/45/49.10/49.12 35.8/35C12/40C12 35/40/50/45C14 35/40/50/45C15/C11 C10/C17/C18 |
| Connessione / Connected:  | | | 931015 |
| 931116  | 93824579 42470845 | - Mozzo ruota anteriore/ <i>Front wheel hub</i> - Con cuscinetti SKF/With SKF bearings | Daily City 2000 35/45/49.10/49.12 35.8/35C12/40C12 35/40/50/45C14 35/40/50/45C15/C11 C10/C17/C18 |
| 931001  | 93824580 | - Mozzo ruota anteriore/ <i>Front wheel hub</i> - Con cuscinetto/ <i>With bearing</i> - Con/ <i>With ABS</i> | Daily City 2000 35/45/49.10/49.12 35.8/35C12/40C12 35/40/50/45C14 35/40/50/45C15/C11 C10/C17/C18 |
| Connessione / Connected:   | | | 931015 931013 |

MOZZI RUOTA
WHEEL HUBS
MOYEURS DE ROUE
RADNABEN
СТУПИЦЫ КОЛЕС
BUJES DE RUEDA

EMMERRE
spare parts for trucks and trailers

IVECO

| Applicazioni / Applications | Dettagli / Detail | Adattabile a / Adaptable to | Emmerre |
|--|---|-----------------------------|---------------|
| Daily City 2000 35/45/49.10/49.12 35.8/35C12 35/40/45/50C14 35/40/45/50C10/11 C15/17/18 | - Mozzo ruota anteriore/ <i>Front wheel hub</i> - Con cuscinetti SKF/With SKF bearings - Con ABS/ <i>With ABS</i> | 93824580 | 931115 |
|  | | | |
| Connessione / Connected:  931013 | | | |
| Daily City 2000 65C11/13/15 | - Mozzo ruota posteriore/ <i>Rear wheel hub</i> - Senza cuscinetto/ <i>Without bearing</i> - Con colonnette/ <i>With bolts</i> | 7181957 | 931017 |
|  | | | |
| Connessione / Connected:  931018  951060  933122  101559 | | | |
| Daily City 2000 65C11/13/15 | - Mozzo ruota posteriore/ <i>Rear wheel hub</i> - Con cuscinetto/ <i>With bearing</i> - Con colonnette/ <i>With bolts</i> | 7181957 | 931144 |
|  | | | |
| Connessione / Connected:  931018  951060  933122  101559 | | | |
| Daily City 2000 65C11/13/15 | - Mozzo ruota posteriore/ <i>Rear wheel hub</i> - Con cuscinetti SKF/With SKF bearings - Con colonnette/ <i>With bolts</i> | 7181957 | 931137 |
|  | | | |
| Connessione / Connected:  951060  933122  101559 | | | |

| Emmerre | Adattabile a / Adaptable to | Dettagli / Detail | Applicazioni / Applications |
|---|-----------------------------|---|--------------------------------|
| 931019 | 42471216 | - Mozzo ruota anteriore/ <i>Front wheel hub</i> - Con cuscinetti/ <i>With bearings</i> - Con predisposizione ABS/ <i>With ABS possibility</i> | Daily City 2000 65C14/15/17 |
|  | | Connessione / Connected:  931021 | |
| 931168 | 42471216 | - Mozzo ruota anteriore/ <i>Front wheel hub</i> - Con cuscinetti SKF/<i>With SKF bearings</i> - Con predisposizione ABS/ <i>With ABS possibility</i> | Daily City 2000 65C14/15/17 |
|  | | Connessione / Connected:  931021 | |
| 931511 | 504166122 | - Mozzo ruota anteriore/ <i>Front wheel hub</i> - Con cuscinetto/ <i>With bearing</i> | Daily City 2000 65C11/13/15 |
|  | | Connessione / Connected:  931022 | |
| 931117 | 504166122 | - Mozzo ruota anteriore/ <i>Front wheel hub</i> - Con cuscinetti SKF/<i>With SKF bearings</i> | Daily City 2000 65C11/13/15 |
|  | | | |

MOZZI RUOTA
WHEEL HUBS
MOYEURS DE ROUE
RADNABEN
СТУПИЦЫ КОЛЕС
BUJES DE RUEDA

EMMERRE
spare parts for trucks and trailers

IVECO

| Applicazioni / Applications | Dettagli / Detail | Adattabile a / Adaptable to | Emmerre |
|--|---|-----------------------------|---------------|
| Daily City 2000 35C12 MY2006 | - Kit mozzo ruota anteriore/ <i>Front kit wheel hub</i> - Con cuscinetto/ <i>With bearing</i> - Con ABS/ <i>With ABS</i> | 504166117 | 931025 |
|  | | | |
| Connessione / Connected:  931022  931013 | | | |
| Daily City 2000 35C12 MY2006 | - Mozzo ruota anteriore/ <i>Front wheel hub</i> - Con cuscinetti SKF/<i>With SKF bearings</i> - Con ABS/ <i>With ABS</i> | 504166117 | 931118 |
|  | | | |
| Connessione / Connected:  931013 | | | |
| Daily City 2000 Daily '96 29/35 L10/12 C10/12 S10/11/13/15 | - Mozzo ruota anteriore/ <i>Front wheel hub</i> - Con cuscinetti/ <i>With bearings</i> | 42470834 | 931002 |
|  | | | |
| Connessione / Connected:  931020 | | | |

Mozzi Ruota
Wheel Hubs

| Emmerre | Adattabile a / Adaptable to | Dettagli / Detail | Applicazioni / Applications |
|--|-----------------------------|---|---|
| 931050 | 93810034 | - Mozzo ruota anteriore/ <i>Front wheel hub</i> - Con cuscinetti/ <i>With bearings</i> | Daily City 2000 New Daily '96 Turbodayly 59.12 |
|   | | | |
| 931082 | 5801341526 | - Mozzo ruota anteriore/ <i>Front wheel hub</i> - Con cuscinetto/ <i>With bearing</i> - Con ABS/ <i>With ABS</i> | Daily 2012 |
|   | | | |
| 931119 | 5801341526 | - Mozzo ruota anteriore/ <i>Front wheel hub</i> - <u>Con cuscinetti SKF/<i>With SKF bearings</i></u> - Con ABS/ <i>With ABS</i> | Daily 2012 |
|   | | | |
| 930999 | 5801341551 | - Mozzo ruota anteriore/ <i>Front wheel hub</i> - Con cuscinetti/ <i>With bearings</i> - Con ABS/ <i>With ABS</i> | Daily 2012 |
|   | | | |

Connessione / Connected:  930971  931014

MOZZI RUOTA
WHEEL HUBS
MOYEURS DE ROUE
RADNABEN
СТУПИЦЫ КОЛЕС
BUJES DE RUEDA





EMMERRE
spare parts for trucks and trailers

IVECO

| Applicazioni / Applications | Dettagli / Detail | Adattabile a / Adaptable to | Emmerre |
|--|--|-----------------------------|---------------|
| Daily 2012 | <ul style="list-style-type: none"> - Mozzo ruota anteriore/<i>Front wheel hub</i> - Con cuscinetti SKF/With SKF bearings - Con ABS/<i>With ABS</i> | 5801341551 | 931140 |
|   | | | |
| Connessione / Connected:  930971 | | | |
| Daily 2012 | <ul style="list-style-type: none"> - Mozzo ruota anteriore/<i>Front wheel hub</i> - Con cuscinetto/<i>With bearing</i> - Con ABS/<i>With ABS</i> | 504207325 | 931071 |
|   | | | |
| Connessione / Connected:  931013  931014 | | | |
| Daily 2012 | <ul style="list-style-type: none"> - Mozzo ruota anteriore/<i>Front wheel hub</i> - Con cuscinetti SKF/With SKF bearings - Con ABS/<i>With ABS</i> | 504207325 | 931141 |
|   | | | |
| Connessione / Connected:  931013 | | | |
| Daily 35S11 MY 2009 | <ul style="list-style-type: none"> - Mozzo ruota anteriore/<i>Front wheel hub</i> - Con cuscinetto/<i>With bearing</i> | 5801341424 | 931109 |
|   | | | |
| Connessione / Connected:  931022 | | | |

Mozzi Ruota
Wheel Hubs

I riferimenti indicati non sono originali ma perfettamente intercambiabili. I codici originali e le case costruttrici sono indicati a puro titolo informativo
The details described are not original but perfectly interchangeable. The original references and manufacturer names are given for information purposes only.

| Emmerre | Adattabile a / Adaptable to | Dettagli / Detail | Applicazioni / Applications |
|--|-----------------------------|--|------------------------------------|
| 931145  | 5801341424 | - Mozzo ruota anteriore/ <i>Front wheel hub</i> - Con cuscinetto SKF/With SKF bearing | Daily 35S11 MY 2009 |
| 931073  | 7168364 | - Mozzo ruota anteriore/ <i>Front wheel hub</i> - Senza colonnette/ <i>Without bolts</i> | Gammazeta Turbozeta |
| Connessione / Connected:  | | | 933012 |
| 931106  | 7185473 | - Mozzo ruota anteriore/ <i>Front wheel hub</i> - Con cuscinetti/ <i>With bearings</i> - Ruota fonica ABS/ <i>ABS ring</i> | Eurocargo 120/140/160 Tector |
| 931105  | 7187043 | - Mozzo ruota anteriore/ <i>Front wheel hub</i> - Con cuscinetti/ <i>With bearings</i> - Ruota fonica ABS/ <i>ABS ring</i> | Eurocargo 120/140/160 Tector |

**MOZZI RUOTA
WHEEL HUBS
MOYEURS DE ROUE
RADNABEN
СТУПИЦЫ КОЛЕС
BUJES DE RUEDA**

EMMERRE
spare parts for trucks and trailers

IVECO

| Applicazioni / Applications | Dettagli / Detail | Adattabile a / Adaptable to | Emmerre |
|--|--|-------------------------------|---|
| Eurocargo 60E10/12/14 65E10/12/14 75E12/14/15 | - Mozzo ruota anteriore/ <i>Front wheel hub</i> - Con cuscinetti/ <i>With bearings</i> - Con distanziale/ <i>With spacer</i> - Senza colonnette/ <i>Without bolts</i> - Con ABS/ <i>With ABS</i> | 7173047 7173046 7173048 | 931029  |
| Connessione / Connected:  931054  951060  931515  931098 | | | |
| Eurocargo 60/65E12/14 Tector Daily 59.12 | - Mozzo ruota posteriore/ <i>Rear wheel hub</i> - Senza colonnette/ <i>Without bolts</i> | 7172993 | 931039  |
| Connessione / Connected:  931018  951066  101559 | | | |
| Eurocargo 60/65E12/14 Tector Daily 59.12 | - Mozzo ruota posteriore/ <i>Rear wheel hub</i> - Senza colonnette/ <i>Without bolts</i> - Con cuscinetti/ <i>With bearings</i> | 7172993 | 930979  |
| Connessione / Connected:  931018  951066  101559 | | | |
| Eurocargo 60/65E12/14 Tector Daily 59.12 | - Mozzo ruota posteriore/ <i>Rear wheel hub</i> - Senza colonnette/ <i>Without bolts</i> - Con cuscinetti SKF/<i>With SKF bearings</i> | 7172993 | 931172  |
| Connessione / Connected:  951066  101559 | | | |



















Mozzi Ruota
Wheel Hubs

EMMERRE

spare parts for trucks and trailers

IVECO











MOZZI RUOTA
WHEEL HUBS
MOYEURS DE ROUE
RADNABEN
СТУПИЦЫ КОЛЕС
BUJES DE RUEDA

| Emmerre | Adattabile a / Adaptable to | Dettagli / Detail | Applicazioni / Applications |
|---|-----------------------------|--|---|
| 931046  | 7177134 | - Mozzo ruota anteriore/ <i>Front wheel hub</i> - Con cuscinetti/ <i>With bearings</i> - Con distanziale/ <i>With spacer</i> - Senza colonnette/ <i>Without bolts</i> | Eurocargo Tector Eurocargo Tector Restyling 65E14 75E12/14/15/13/17/18 |
| Connessione / Connected:  931054-931055  951060  931513 | | | |
| 931033  | 7173747 | - Mozzo ruota anteriore/ <i>Front wheel hub</i> - Con cuscinetti/ <i>With bearings</i> - Con distanziale/ <i>With spacer</i> - Senza colonnette/ <i>Without bolts</i> - Con ABS/ <i>With ABS</i> | Eurocargo Eurocargo Tector 80E15/18/21 100E15/18/21/17 85/95E18 180E21 |
| Connessione / Connected:  931054-931055  951059  931513  931098 | | | |
| 931035  | 7173696 | - Mozzo ruota posteriore/ <i>Rear wheel hub</i> - Senza colonnette/ <i>Without bolts</i> | Eurocargo 80/85 E15/18 80/E18/21 100E15/18/17/21 95E18 180E21 |
| Connessione / Connected:  933115  931091  931516  101559 | | | |
| 930993  | 7173696 | - Mozzo ruota posteriore/ <i>Rear wheel hub</i> - Senza colonnette/ <i>Without bolts</i> - Con cuscinetti/ <i>With bearings</i> | Eurocargo 80/85 E15/18 80/E18/21 100E15/18/17/21 95E18 180E21 |
| Connessione / Connected:  933115  931091  931516  101559 | | | |

**MOZZI RUOTA
WHEEL HUBS
MOYEURS DE ROUE
RADNABEN
СТУПИЦЫ КОЛЕС
BUJES DE RUEDA**

EMMERRE
spare parts for trucks and trailers

IVECO

| Applicazioni / Applications | Dettagli / Detail | Adattabile a / Adaptable to | Emmerre |
|---|--|-------------------------------|---------------|
| Eurocargo Tector Eurotech 120E15/18/23 130E15/18/23/24 | - Mozzo ruota anteriore/ <i>Front wheel hub</i> - Con cuscinetti/ <i>With bearings</i> - Con distanziale/ <i>With spacer</i> - Senza colonnette/ <i>Without bolts</i> | 7182046 7172885 7182048 | 931048 |
|  | | | |
| Connessione / Connected:  931056  933021  931514 | | | |
| Eurocargo 180E21/24 28-260 E28 Tector Euro rider Eurostar 260/Cursor Eurotech 190/440/260 Stralis 440/260 Tector Restyling Eurotrakker Cursor 190/440/260/380/340 | - Mozzo ruota anteriore/ <i>Front wheel hub</i> - Con colonnette/ <i>With bolts</i> | 7188706 7183906 7180797 | 931041 |
|  | | | |
| Connessione / Connected:  931064  933020  931517 | | | |
| Eurocargo 180E21/24 28-260 E28 Tector Euro rider Eurostar 260/Cursor Eurotech 190/440/260 Stralis 440/260 Tector Restyling Eurotrakker Cursor 190/440/260/380/340 | - Mozzo ruota anteriore/ <i>Front wheel hub</i> - Con colonnette/ <i>With bolts</i> - Con cuscinetti/ <i>With bearings</i> | 7188706 7183906 7180797 | 930977 |
|  | | | |
| Connessione / Connected:  931064  933020  931517 | | | |
| Eurocargo Tector 180/260 Eurotech 400/190 Eurostar 180/400/440/190/240/260 Eurotrakker 190/400/260/ 440/380/720/340/410 Stralis 440/260 Cursor Eurocargo 170 Eurocargo Restyling 180 | - Mozzo Ruota anteriore/ <i>Front wheel hub</i> - Con colonnette/ <i>With bolts</i> - Con cuscinetti/ <i>With bearings</i> | 7180797 | 931084 |
|  | | | |
| Connessione / Connected:  931064  951065  931517 | | | |

Mozzi Ruota
Wheel Hubs

















I riferimenti indicati non sono originali ma perfettamente intercambiabili. I codici originali e le case costruttrici sono indicati a puro titolo informativo
The details described are not original but perfectly interchangeable. The original references and manufacturer names are given for information purposes only.

EMMERRE

spare parts for trucks and trailers

IVECO















MOZZI RUOTA
WHEEL HUBS
MOYEURS DE ROUE
RADNABEN
СТУПИЦЫ КОЛЕС
BUJES DE RUEDA

| Emmerre | Adattabile a / Adaptable to | Dettagli / Detail | Applicazioni / Applications |
|---|-----------------------------|--|--|
| 931043 | 7179777 42551244 | - Mozzo ruota posteriore/Rear wheel hub - Con colonnette/With bolts | Eurocargo Tector Restyling 180 Eurorider Eurostar Cursor 440 Eurotech 440 Cursor Stralis 440/260/190 Tector Restyling |
|  | | Connessione / Connected:  931057  951068 | |
| 930986 | 7179777 42551244 | - Mozzo ruota posteriore/Rear wheel hub - Con colonnette/With bolts - Con cuscinetti/With bearings | Eurocargo Tector Restyling 180 Eurorider Eurostar Cursor 440 Eurotech 440 Cursor Stralis 440/260/190 Tector Restyling |
|   | | Connessione / Connected:  931057  951068 | |
| 931215 | 7179777 42551244 | - Mozzo ruota posteriore/Rear wheel hub - Con colonnette/With bolts - Con cuscinetti SKF/With SKF bearings | Eurocargo Tector Restyling 180 Eurorider Eurostar Cursor 440 Eurotech 440 Cursor Stralis 440/260/190 Tector Restyling |
|   | | Connessione / Connected:  931078  951068 | |
| 931146 | 7183908 | - Mozzo Ruota anteriore/Front wheel hub - Con colonnette/With bolts - 3° assale/3° axle | Stralis 440/260 Cursor |
|   | | Connessione / Connected:  931064  951065  931517 | |



**MOZZI RUOTA
WHEEL HUBS
MOYEURS DE ROUE
RADNABEN
СТУПИЦЫ КОЛЕС
BUJES DE RUEDA**

EMMERRE
spare parts for trucks and trailers

IVECO

| Applicazioni / Applications | Dettagli / Detail | Adattabile a / Adaptable to | Emmerre |
|--|--|-----------------------------|---------------|
| Eurocargo 150E18 E24/28 | <ul style="list-style-type: none"> - Mozzo ruota anteriore/<i>Front wheel hub</i> - Con cuscinetti/<i>With bearings</i> - Con distanziale/<i>With spacer</i> - Senza colonnette/<i>Without bolts</i> | 7182040 | 931036 |
|  | | | |
| Connessione / Connected:  931056  951068  931514 | | | |
| Eurocargo 65/80E14/15/21 | <ul style="list-style-type: none"> - Mozzo ruota anteriore/<i>Front wheel hub</i> - Senza colonnette/<i>Without bolts</i> | 7189266 | 931095 |
|  | | | |
| Connessione / Connected:  931054-931055  931098  931513 | | | |
| Eurocargo 65/80E14/15/21 | <ul style="list-style-type: none"> - Mozzo ruota anteriore/<i>Front wheel hub</i> - Senza colonnette/<i>Without bolts</i> - Con cuscinetti/<i>With bearings</i> | 7189266 7189272 | 931104 |
|  | | | |
| Connessione / Connected:  931054-931055  931098  931513 | | | |
| Eurocargo 135/150/140 Cursor Eurotrakker 190/180/400/260 380/720/410 | <ul style="list-style-type: none"> - Mozzo ruota anteriore/<i>Front wheel hub</i> - Senza colonnette/<i>Without bolts</i> | 42115016 | 931037 |
|  | | | |
| Connessione / Connected:  931087-930996  951064  101567 | | | |

Mozzi Ruota
Wheel Hubs

| Emmerre | Adattabile a / Adaptable to | Dettagli / Detail | Applicazioni / Applications |
|---|-----------------------------|---|---|
| 931049 | 7186804 | - Mozzo ruota posteriore/Rear wheel hub - Con colonnette/With bolts | Stralis 440/260 Cursor 190 Eurocargo Tector 180 |
|  | | | |
| Connessione / Connected:  931057  951068 | | | |
| 930976 | 7186804 | - Mozzo ruota posteriore/Rear wheel hub - Con colonnette/With bolts - Con cuscinetti/With bearings | Stralis 440/260 Cursor 190 Eurocargo Tector 180 |
|   | | | |
| Connessione / Connected:  931057  951068 | | | |
| 931216 | 7186804 | - Mozzo ruota posteriore/Rear wheel hub - Con colonnette/With bolts - Con cuscinetti SKF/With SKF bearings | Stralis 440/260 Cursor 190 Eurocargo Tector 180 |
|   | | | |
| Connessione / Connected:  931078  951068 | | | |
| 931034 | 7173314 7173315 | - Mozzo ruota anteriore/Front wheel hub - Con colonnette/With bolts | Eurocargo 170 Eurotech 180/325 400/190 |
|  | | | |
| Connessione / Connected:  931064  951068  931517 | | | |

**MOZZI RUOTA
WHEEL HUBS
MOYEURS DE ROUE
RADNABEN
СТУПИЦЫ КОЛЕС
BUJES DE RUEDA**

















EMMERRE
spare parts for trucks and trailers

IVECO

| Applicazioni / Applications | Dettagli / Detail | Adattabile a / Adaptable to | Emmerre |
|---|---|----------------------------------|---------------|
| Turbostar 190.42 Turbotech 220.36/32 190.26/30 330.26/30/35/36 | - Mozzo ruota anteriore/ <i>Front wheel hub</i> - Con colonnette/ <i>With bolts</i> | 7168586 7168588 | 931030 |
| Connessione / Connected:  931058  930995-930994  101406 | | | |
| Turbostar 190.42/48 Turbotech 190.26/32/30 220.36 240/260.36 190.36 | - Mozzo ruota posteriore/ <i>Rear wheel hub</i> - Con colonnette/ <i>With bolts</i> | 7168464 7168589 | 931031 |
| Connessione / Connected:  933017  931090-931094  101507-101519 | | | |
| 330 All types 190.26/30 Turbocity | - Mozzo ruota posteriore/ <i>Rear wheel hub</i> - Con colonnette/ <i>With bolts</i> | 42101362 42101959 42037491 | 931040 |
| Connessione / Connected:  933016  931083-930997  101507-101519 | | | |
| Eurotech Eurotrakker Cursor 190/260 400/440/330/380/720 330.30 AP 160 | - Mozzo ruota posteriore/ <i>Rear wheel hub</i> - Senza colonnette/ <i>Without bolts</i> | 42104691 | 931032 |
| Connessione / Connected:  931083-930997  933016  103640 | | | |

Mozzi Ruota
Wheel Hubs













I riferimenti indicati non sono originali ma perfettamente intercambiabili. I codici originali e le case costruttrici sono indicati a puro titolo informativo
The details described are not original but perfectly interchangeable. The original references and manufacturer names are given for information purposes only.





| Emmerre | Adattabile a / Adaptable to | Dettagli / Detail | Applicazioni / Applications |
|---|-----------------------------|---|---|
| 930982 | 42104691 | - Mozzo ruota posteriore/Rear wheel hub - Senza colonnette/Without bolts - Con cuscinetti/With bearings | Eurotech Eurotrakker Cursor 190/260 400/440/330/380/720 330.30 AP 160 |
|  | | | |
| Connessione / Connected:  931083-930997  933016  103640 | | | |
| 931070 | 7182031 7173326 | - Mozzo ruota anteriore/Front wheel hub - Con colonnette/With bolts | Eurotech Eurotrakker Cursor |
|  | | | |
| Connessione / Connected:  931064  951069  931517 | | | |
| 931044 | 42101918 | - Mozzo ruota posteriore/Rear wheel hub - Senza colonnette/Without bolts | Eurotech Eurotech Cursor Eurotrakker Eurotrakker Cursor |
|  | | | |
| Connessione / Connected:  931083-930997  933016  103635  101519-101587 | | | |
| 931023 | 7182032 | - Mozzo ruota anteriore/Front wheel hub - Con colonnette/With bolts | Eurotech Eurostar Eurotrakker Cursor |
|  | | | |
| Connessione / Connected:  931064  951069  931517 | | | |

MOZZI RUOTA
WHEEL HUBS
MOYEURS DE ROUE
RADNABEN
СТУПИЦЫ КОЛЕС
BUJES DE RUEDA

EMMERRE
spare parts for trucks and trailers

IVECO

| Applicazioni / Applications | Dettagli / Detail | Adattabile a / Adaptable to | Emmerre |
|---|--|-----------------------------|---------------|
| Eurotech Eurostar Eurotrakker Cursor | - Mozzo ruota anteriore/ <i>Front wheel hub</i> - Con colonnette/ <i>With bolts</i> - Con cuscinetti/ <i>With bearings</i> | 7182032 | 930989 |
|  | | | |
| Connessione / Connected:  931064  951069  931517 | | | |
| Eurotech Eurostar Cursor Stralis | - Mozzo ruota posteriore/ <i>Rear wheel hub</i> - Con colonnette/ <i>With bolts</i> | 7180909 | 931038 |
|  | | | |
| Connessione / Connected:  931057  951064 | | | |
| Eurotech Eurostar Cursor Stralis | - Mozzo ruota posteriore/ <i>Rear wheel hub</i> - Con colonnette/ <i>With bolts</i> - Con cuscinetti/ <i>With bearings</i> | 7180909 | 930980 |
|  | | | |
| Connessione / Connected:  931057  951064 | | | |
| Eurotech Eurostar Cursor Stralis | - Mozzo ruota posteriore/ <i>Rear wheel hub</i> - Con colonnette/ <i>With bolts</i> - Con cuscinetti SKF/<i>With SKF bearings</i> | 7180909 | 930974 |
|  | | | |
| Connessione / Connected:  931078  951064 | | | |

| Emmerre | Adattabile a / <i>Adaptable to</i> | Dettagli / <i>Detail</i> | Applicazioni / <i>Applications</i> |
|--|---|---|---|
| <p>931042</p>  | <p>7181782 7179929 42551247</p> | <p>- Mozzo ruota posteriore/<i>Rear wheel hub</i> - Con colonnette/<i>With bolts</i></p> | <p>Eurostar 440/190/400/240 Eurotech 190/440/240</p> |
| <p>Connessione / <i>Connected</i>:  931094-931090  951067  101511</p> | | | |



**MOZZI RUOTA
WHEEL HUBS
MOYEURS DE ROUE
RADNABEN
СТУПИЦЫ КОЛЕС
BUJES DE RUEDA**

EMMERRE
spare parts for trucks and trailers

MAN

| Applicazioni / Applications | Dettagli / Detail | Adattabile a / Adaptable to | Emmerre |
|-----------------------------|--|---|--|
| F 2000 TGA TGS TGX | - Mozzo ruota anteriore-posteriore/ <i>Front and rear wheel hub</i> - Con cuscinetti/ <i>With bearings</i> - Con ABS/ <i>With ABS</i> | 81934200288 81934200330 81934200349 | 931062  |
| TGL TGM L2000 | - Mozzo ruota anteriore/ <i>Front wheel hub</i> - Con cuscinetti/ <i>With bearings</i> - Con ABS/ <i>With ABS</i> | 81934200337 | 931100  |
| TGA TGS TGX | - Mozzo ruota anteriore/ <i>Front wheel hub</i> | 81934200353 | 931153  |
| V9-40L | - Mozzo ruota anteriore/ <i>Front wheel hub</i> | 81443010169 | 931156  |

Mozzi Ruota
Wheel Hubs

| Emmerre | Adattabile a / Adaptable to | Dettagli / Detail | Applicazioni / Applications |
|---------------|-----------------------------|---|---|
| 931110 | 81357006136 | - Mozzo ruota posteriore/Rear wheel hub - Senza cuscinetti/Without bearings | TGA |
| | | | Connessione / Connected:  931060 |
| 931112 | 81357006150 | - Mozzo ruota posteriore/Rear wheel hub - Con cuscinetti/With bearings | TGA |
| | | | Connessione / Connected:  931060 |
| 931072 | 81357010155 | - Mozzo ruota posteriore/Rear wheel hub - Senza cuscinetti/Without bearings | TGA TGM TGS TGX |
| | | | Connessione / Connected:  931061 |
| 931101 | 81357010155 | - Mozzo ruota posteriore/Rear wheel hub - Con cuscinetti/With bearings - Con ABS/With ABS | TGA TGM TGS TGX |
| | | | Connessione / Connected:  931061  101552-101556 |

MOZZI RUOTA
WHEEL HUBS
MOYEURS DE ROUE
RADNABEN
СТУПИЦЫ КОЛЕС
BUJES DE RUEDA

EMMERRE
spare parts for trucks and trailers

MAN

| Applicazioni / Applications | Dettagli / Detail | Adattabile a / Adaptable to | Emmerre |
|-----------------------------|---|-----------------------------|---------------|
| TGA TGS TGX | - Mozzo ruota posteriore/Rear wheel hub | 81357010128 | 931154 |



| | | | |
|--------------------|---|----------------------------|---------------|
| HY-1175HY 13110 | - Mozzo ruota posteriore/Rear wheel hub | 81357010159 81357010142 | 931155 |
|--------------------|---|----------------------------|---------------|









Mozzi Ruota
Wheel Hubs

EMMERRE

spare parts for trucks and trailers

MERCEDES











MOZZI RUOTA
WHEEL HUBS
MOYEURS DE ROUE
RADNABEN
СТУПИЦЫ КОЛЕС
BUJES DE RUEDA











| Emmerre | Adattabile a / Adaptable to | Dettagli / Detail | Applicazioni / Applications |
|---|--|---|---|
| 931817  | 9753300825 9753300425 | - Mozzo ruota anteriore/ <i>Front wheel hub</i> - Con cuscinetti/ <i>With bearings</i> - Con ABS/ <i>With ABS</i> | Atego |
| Connessione / Connected:  931086 | | | |
| 931824  | 9723300525 9723300125 | - Mozzo ruota anteriore/ <i>Front wheel hub</i> - Con cuscinetti/ <i>With bearings</i> - Con ABS/ <i>With ABS</i> | Atego |
| 931831  | 972330042505 972330042527 | - Mozzo ruota anteriore/ <i>Front wheel hub</i> - Con cuscinetti/ <i>With bearings</i> - Con colonnette/ <i>With bolt</i> - Con ABS/ <i>With ABS</i> | Atego |
| 931815  | 9433301225 9433301125 0003300725 | - Mozzo ruota anteriore/ <i>Front wheel hub</i> - Con cuscinetti/ <i>With bearings</i> | Atego Actros MP2/MP3 Axor Axor 2 Econic |
| Connessione / Connected:  931816 | | | |

MOZZI RUOTA
WHEEL HUBS
MOYEURS DE ROUE
RADNABEN
СТУПИЦЫ КОЛЕС
BUJES DE RUEDA

EMMERRE
spare parts for trucks and trailers

MERCEDES

| Applicazioni / Applications | Dettagli / Detail | Adattabile a / Adaptable to | Emmerre |
|---|---|---|--|
| Atego Actros MP2/MP3 Axor Axor 2 Econic | - Mozzo ruota anteriore/ <i>Front wheel hub</i> - Con cuscinetti SKF/With SKF bearings | 9433301225 9433301125 0003300725 | 931810  |
| | |  |  |
| Actros | - Mozzo ruota anteriore/ <i>Front wheel hub</i> - Senza cuscinetti/ <i>Without bearings</i> | 9423341501 9423341201 9423340701 | 931825 |
| | | |  |
| Connessione / Connected:  931813-931812 | | | |
| Actros | - Mozzo ruota anteriore/ <i>Front wheel hub</i> - Con cuscinetti/ <i>With bearings</i> - Con ABS/ <i>With ABS</i> | 9423341501 9423341201 9423340701 | 931829 |
| | |  |  |
| Connessione / Connected:  931813-931812  931133 | | | |
| Actros | - Mozzo ruota anteriore/ <i>Front wheel hub</i> - Senza cuscinetti/ <i>Without bearings</i> | 9423341401 9423340301 | 931828 |
| | | |  |
| Connessione / Connected:  931108-930994 | | | |

| Emmerre | Adattabile a / Adaptable to | Dettagli / Detail | Applicazioni / Applications |
|---|---|---|-----------------------------|
| 931840 | 9423341401 9423340301 | - Mozzo ruota anteriore/ <i>Front wheel hub</i> - Con cuscinetti/ <i>With bearings</i> - Con ABS/ <i>With ABS</i> | Actros |
|  |  | Connessione / Connected:  931108-930994  931135 | |
| 931823 | 9703560301 9703500335 | - Mozzo ruota posteriore/ <i>Rear wheel hub</i> - Senza cuscinetti/ <i>Without bearings</i> | Atego |
|  | Connessione / Connected:  931086 | | |
| 931835 | 9703500335 9703560301 | - Mozzo ruota posteriore/ <i>Rear wheel hub</i> - Con cuscinetti/ <i>With bearings</i> | Atego |
|  |  | Connessione / Connected:  931086 | |
| 931814 | 9763561801 9763561101 | - Mozzo ruota posteriore/ <i>Rear wheel hub</i> - Senza cuscinetti/ <i>Without bearings</i> | Atego |
|  | | | |



MOZZI RUOTA
WHEEL HUBS
MOYEURS DE ROUE
RADNABEN
СТУПИЦЫ КОЛЕС
BUJES DE RUEDA

EMMERRE
spare parts for trucks and trailers

MERCEDES

| Applicazioni / Applications | Dettagli / Detail | Adattabile a / Adaptable to | Emmerre |
|---|---|-----------------------------|---------------|
| Atego | <ul style="list-style-type: none"> - Mozzo ruota posteriore/Rear wheel hub - Con cuscinetti/With bearings - Con ABS/With ABS | 9763561801 9763561101 | 931811 |
|  | | | |
| Connessione / Connected:  931394-931397  931136 | | | |
| Actros Axor | <ul style="list-style-type: none"> - Mozzo ruota posteriore/Rear wheel hub - Senza cuscinetti/Without bearings | 9463560701 | 931833 |
|  | | | |
| 0403/0404 0350 BUS Truck | <ul style="list-style-type: none"> - Mozzo ruota posteriore/Rear wheel hub - Senza cuscinetti/Without bearings | 3563560001 | 931807 |
|  | | | |
| Bus/Truck 302/303/304 | <ul style="list-style-type: none"> - Mozzo ruota posteriore/Rear wheel hub - Senza cuscinetti/Without bearings | 3853561401 3853560601 | 931868 |
|  | | | |

Mozzi Ruota
Wheel Hubs

| Emmerre | Adattabile a / Adaptable to | Dettagli / Detail | Applicazioni / Applications |
|--|--|--|--|
| 931832  <p>x10 pcs</p> | 0003502335 0003500535 | - Con cuscinetti/With bearings Emmerre - Con ABS/With ABS - Con bulloni/With bolts | Axles Mercedes TE4 TE5 VT |
| | | Connessione / Connected:  931816  931130 | |
| 931827  <p>x10 pcs</p> | 0003502335 0003500535 | - <u>Con cuscinetti SKF/With SKF bearings</u> - Con ABS/With ABS - Con bulloni/With bolts | Axles Mercedes TE4 TE5 VT |
| | | Connessione / Connected:  931130 | |
| 931836  | 9463561901 9463561801 9463560901 9463560201 | - Mozzo ruota posteriore/Rear wheel hub - Senza cuscinetti/Without bearings | Atego MP3 Actros Axor Travego |

MOZZI RUOTA
WHEEL HUBS
MOYEURS DE ROUE
RADNABEN
СТУПИЦЫ КОЛЕС
BUJES DE RUEDA

EMMERRE
spare parts for trucks and trailers

NISSAN

| Applicazioni / Applications | Dettagli / Detail | Adattabile a / Adaptable to | Emmerre |
|--|--|-----------------------------|---------------|
| Cabstar | <ul style="list-style-type: none"> - Mozzo ruota posteriore/Rear wheel hub - Con cuscinetti/With bearings - Con colonnette/With bolts | 43202F3903 | 931701 |
|  | | | |
| Connessione / Connected:  931701.10 | | | |

Mozzi Ruota
Wheel Hubs

Emmerre

Adattabile a / *Adaptable to*

Dettagli / *Detail*

Applicazioni / *Applications*

931251

23115100

- Senza cuscinetti/*Without bearings*



Axles 14 ton



MOZZI RUOTA
WHEEL HUBS
MOYEURS DE ROUE
RADNABEN
СТУПИЦЫ КОЛЕС
BUJES DE RUEDA

EMMERRE
spare parts for trucks and trailers

RENAULT































| Applicazioni / Applications | Dettagli / Detail | Adattabile a / Adaptable to | Emmerre |
|--------------------------------------|---|--|---|
| Kerax Magnum Midlum Premium | - Mozzo ruota anteriore/ <i>Front wheel hub</i> - Con ABS/ <i>with ABS</i> - Con cuscinetto/ <i>With bearing</i> | 5010439770 | 931068 |
| | |  |  |
| Kerax Midlum | - Mozzo ruota anteriore/ <i>Front wheel hub</i> - Con cuscinetti/ <i>With bearings</i> - Con ABS/ <i>with ABS</i> | 7421190412 5010566154 | 931096 |
| | |  |  |
| Magnum Premium Kerax Major | - Mozzo ruota anteriore/ <i>Front wheel hub</i> - Con cuscinetti/ <i>With bearings</i> - Con ABS/ <i>with ABS</i> | 7420879770 5010216920 | 931097 |
| | |  |  |
| Midlum | - Mozzo ruota anteriore/ <i>Front wheel hub</i> - Con cuscinetti/ <i>With bearings</i> - Con ABS/ <i>with ABS</i> | 5010587029 | 931487 |
| | |  |  |

EMMERRE

spare parts for trucks and trailers

RENAULT

MOZZI RUOTA
WHEEL HUBS
MOYEURS DE ROUE
RADNABEN
СТУПИЦЫ КОЛЕС
BUJES DE RUEDA

| Emmerre | Adattabile a / Adaptable to | Dettagli / Detail | Applicazioni / Applications |
|--|-----------------------------|--|-----------------------------|
| 931427    x10 pcs  | 7485114470 7420535202 | - Mozzo ruota anteriore/ <i>Front wheel hub</i> - Con cuscinetti/ <i>With bearings</i> - Con colonnette/ <i>With bolts</i> - Con ABS/ <i>with ABS</i> | Kerax Premium |
| Connessione / Connected:  960456  931423  951074  931122 | | | |
| 931440    x10 pcs  | 7485114470 7420535202 | - Mozzo ruota anteriore/ <i>Front wheel hub</i> - Con colonnette/ <i>With bolts</i> - Con ABS/ <i>with ABS</i> - Con cuscinetti FAG/<i>With FAG bearings</i> | Kerax Premium |
| Connessione / Connected:  960456  951074  931122 | | | |
| 931433    x10 pcs  | 7421022433 | - Mozzo ruota anteriore/ <i>Front wheel hub</i> - Con cuscinetti/ <i>With bearings</i> - Con colonnette/ <i>With bolts</i> - Con ABS/ <i>with ABS</i> | Kerax Magnum Premium |
| Connessione / Connected:  960456  931424  951074  931120 | | | |
| 931443    x10 pcs  | 7421022433 | - Mozzo ruota anteriore/ <i>Front wheel hub</i> - Con colonnette/ <i>With bolts</i> - Con ABS/ <i>with ABS</i> - Con cuscinetti FAG/<i>With FAG bearings</i> | Kerax Magnum Premium |
| Connessione / Connected:  960456  951074  931120 | | | |

MOZZI RUOTA
WHEEL HUBS
MOYEURS DE ROUE
RADNABEN
СТУПИЦЫ КОЛЕС
BUJES DE RUEDA

EMMERRE
spare parts for trucks and trailers

RENAULT

| Applicazioni / Applications | Dettagli / Detail | Adattabile a / Adaptable to | Emmerre |
|--|---|--|---|
| Kerax Premium | - Mozzo ruota anteriore/ <i>Front wheel hub</i> - Con cuscinetti/ <i>With bearings</i> - Con ABS/ <i>with ABS</i> | 7421024160 | 931422 |
| Connessione / Connected:  931423  931129 | |  |   |
| Kerax Premium | - Mozzo ruota posteriore/ <i>Rear wheel hub</i> - Senza cuscinetti/ <i>Without bearings</i> | -- | 931435 |
| Connessione / Connected:  931425 | | |  |
| Kerax Premium | - Mozzo ruota posteriore/ <i>Rear wheel hub</i> - Con cuscinetti/ <i>With bearings</i> - Con ABS/ <i>with ABS</i> | 7421328181 7420820402 | 931436 |
| Connessione / Connected:  931425  931121 | |  |  |
| Kerax Premium | - Mozzo ruota posteriore/ <i>Rear wheel hub</i> - Con ABS/ <i>with ABS</i> - Con cuscinetti FAG/<i>With FAG bearings</i> | 7421328181 7420820402 | 931471 |
| Connessione / Connected:  931121 | |  |   |

EMMERRE

spare parts for trucks and trailers

RENAULT

MOZZI RUOTA
WHEEL HUBS
MOYEURS DE ROUE
RADNABEN
СТУПИЦЫ КОЛЕС
BUJES DE RUEDA

| Emmerre | Adattabile a / Adaptable to | Dettagli / Detail | Applicazioni / Applications |
|--|--|---|-----------------------------|
| 931426   | 7420535263 7485107753  x12 pcs  x10 pcs  | - Mozzo ruota posteriore/Rear wheel hub - Con cuscinetti/With bearings - Con colonnette/With bolts - Con ABS/with ABS | Kerax Magnum Premium |
| Connessione / Connected:  960456  931425  951071  931121 | | | |
| 931438   | 7420535263 7485107753  x10 pcs  x12 pcs  | - Mozzo ruota posteriore/Rear wheel hub - Con colonnette/With bolts - Con ABS/with ABS - Con cuscinetti FAG/With FAG bearings | Kerax Magnum Premium |
| Connessione / Connected:  960456  951071  931121 | | | |
| 931448  | 7485109244 7420819826  | - Mozzo ruota posteriore/Rear wheel hub - Con cuscinetti/With bearings - Con ABS/with ABS | Magnum Premium |
| Connessione / Connected:  960456  931425  951071  931121 | | | |
| 931486   | 7485109244 7420819826  | - Mozzo ruota posteriore/Rear wheel hub - Con cuscinetti FAG/With FAG bearings - Con ABS/with ABS | Magnum Premium |
| Connessione / Connected:  960456  951071  931121 | | | |

MOZZI RUOTA
WHEEL HUBS
MOYEURS DE ROUE
RADNABEN
СТУПИЦЫ КОЛЕС
BUJES DE RUEDA

EMMERRE
spare parts for trucks and trailers

RENAULT

| Applicazioni / Applications | Dettagli / Detail | Adattabile a / Adaptable to | Emmerre |
|-----------------------------|---|-----------------------------|---------------|
| Kerax Premium | - Mozzo ruota posteriore/Rear wheel hub - Con cuscinetti/With bearings - Con ABS/with ABS | 7420820420 7420819822 | 931107 |









| | | |
|--------------------------|--|--|
| Connessione / Connected: |  931425 |  931121 |
|--------------------------|--|--|

| | | | |
|------------------|--|--------------------------|---------------|
| Kerax Premium | - Mozzo ruota posteriore/Rear wheel hub - Con ABS/with ABS - Con cuscinetti FAG/With FAG bearings | 7420820420 7420819822 | 931472 |
|------------------|--|--------------------------|---------------|











| | |
|--------------------------|--|
| Connessione / Connected: |  931121 |
|--------------------------|--|

| Emmerre | Adattabile a / Adaptable to | Dettagli / Detail | Applicazioni / Applications |
|--|-----------------------------|---|-----------------------------|
| 931501/N | 1422545 | <ul style="list-style-type: none"> - Mozzo Ruota Technobrake/ Technobrake wheel hub - Mozzo ruota/Wheel hub - Senza cuscinetti/Without bearings | Axle LM |
| Connessione / Connected:  931076  101537 | | | |
| 931501 | 14225425 | <ul style="list-style-type: none"> - Mozzo Ruota Technobrake/ Technobrake wheel hub - Mozzo ruota/Wheel hub - Con cuscinetti/With bearings - Con calotta/With cover | Axle LM |
| Connessione / Connected:  931076  101537  931534 | | | |
| 931521 | 14225425 | <ul style="list-style-type: none"> - Mozzo Ruota Technobrake/ Technobrake wheel hub - Mozzo ruota/Wheel hub - Con cuscinetti SKF/With SKF bearings - Con calotta O.E./With O.E. cover | Axle LM |
| Connessione / Connected:  101537 | | | |







MOZZI RUOTA
WHEEL HUBS
MOYEURS DE ROUE
RADNABEN
СТУПИЦЫ КОЛЕС
BUJES DE RUEDA

EMMERRE
spare parts for trucks and trailers

ROR

| Applicazioni / Applications | Dettagli / Detail | Adattabile a / Adaptable to | Emmerre |
|---|---|-----------------------------|-----------------|
| Axle LM | - Mozzo Ruota Technobrake/ <i>Technobrake wheel hub</i> - Senza cuscinetti/ <i>Without bearings</i> | 14224748 | 931502/N |
|  | | | |
| Connessione / Connected:  931076  101537 | | | |
| Axle LM | - Mozzo Ruota Technobrake/ <i>Technobrake wheel hub</i> - Con cuscinetti/ <i>With bearings</i> | 14224748 | 931502 |
|  | | | |
| Connessione / Connected:  931076  101537  931534 | | | |
| Axle LM | - Mozzo Ruota Technobrake/ <i>Technobrake wheel hub</i> - Mozzo ruota/ <i>Wheel hub</i> - Con cuscinetti SKF/<i>With SKF bearings</i> - Con calotta O.E./<i>With O.E. cover</i> | 14224748 | 931522 |
|  | | | |
| Connessione / Connected:  101537 | | | |



Mozzi Ruota
Wheel Hubs





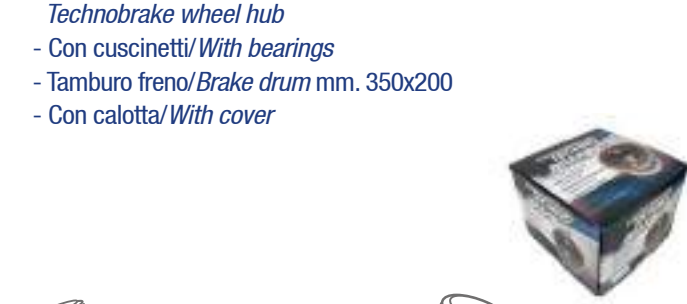

| Emmerre | Adattabile a / Adaptable to | Dettagli / Detail | Applicazioni / Applications |
|--|-----------------------------|---|-----------------------------|
| 931500/N | 21204561 21204562 | - Mozzo Ruota Technobrake/ Technobrake wheel hub - Senza cuscinetti/Without bearings - Ruote gemellate/Twin wheels | Axle TM 33000 |
| Connessione / Connected:  931075-931074  101548 | | | |
| 931500 | 14204562 14204561 | - Mozzo Ruota Technobrake/ Technobrake wheel hub - Con cuscinetti/With bearings - Ruote gemellate/Twin wheels - Con calotta/With cover | Axle TM 33000 |
| Connessione / Connected:  931075-931074  101548  931536 | | | |
| 931525 | 14204562 14204561 | - Mozzo Ruota Technobrake/ Technobrake wheel hub - Mozzo ruota/Wheel hub - Con cuscinetti SKF/With SKF bearings - Ruote gemellate/Twin wheels - Con calotta O.E./With O.E. cover | Axle TM 33000 |
| Connessione / Connected:  101548 | | | |

MOZZI RUOTA
WHEEL HUBS
MOYEURS DE ROUE
RADNABEN
СТУПИЦЫ КОЛЕС
BUJES DE RUEDA

EMMERRE
spare parts for trucks and trailers

ROR







| Applicazioni / Applications | Dettagli / Detail | Adattabile a / Adaptable to | Emmerre |
|--|---|-----------------------------|-----------------|
| Axle TM 15" 10 holes | - Mozzo Ruota Technobrake/ <i>Technobrake wheel hub</i> - Senza cuscinetti/ <i>Without bearings</i> - Tamburo freno/ <i>Brake drum mm. 350x200</i> | 21203219 | 931504/N |
|  | | | |
| Connessione / Connected: 931075-931074 101548 | | | |
| Axle TM 15" 10 holes | - Mozzo Ruota Technobrake/ <i>Technobrake wheel hub</i> - Con cuscinetti/ <i>With bearings</i> - Tamburo freno/ <i>Brake drum mm. 350x200</i> - Con calotta/ <i>With cover</i> | 14203219 | 931504 |
|  | | | |
| Connessione / Connected: 931075-931074 101548 931536 | | | |
| Axle TM 15" 10 holes | - Mozzo Ruota Technobrake/ <i>Technobrake wheel hub</i> - Mozzo ruota/ <i>Wheel hub</i> - Con cuscinetti SKF/<i>With SKF bearings</i> - Tamburo freno/ <i>Brake drum mm. 350x200</i> - Con calotta O.E./<i>With O.E. cover</i> | 14203219 | 931526 |
|  | | | |
| Connessione / Connected: 101548 | | | |

| Emmerre | Adattabile a / Adaptable to | Dettagli / Detail | Applicazioni / Applications |
|--|-----------------------------|--|-----------------------------|
| 931507/N | 14227483 | <ul style="list-style-type: none"> - Mozzo Ruota Technobrake/ Technobrake wheel hub - Mozzo ruota/Wheel hub - Senza cuscinetti/Without bearings - Ruote gemellate/Twin wheels | Axle LM |
| Connessione / Connected:  931076  101537 | | | |
| 931507 | 14227483 | <ul style="list-style-type: none"> - Mozzo Ruota Technobrake/ Technobrake wheel hub - Mozzo ruota/Wheel hub - Con cuscinetti/With bearings - Ruote gemellate/Twin wheels - Con calotta/With cover | Axle LM |
| Connessione / Connected:  931076  101537  931534 | | | |
| 931523 | 14227483 | <ul style="list-style-type: none"> - Mozzo Ruota Technobrake/ Technobrake wheel hub - Mozzo ruota/Wheel hub - Con cuscinetti SKF/With SKF bearings - Con calotta O.E./With O.E. cover | Axle LM |
| Connessione / Connected:  101537 | | | |

MOZZI RUOTA
WHEEL HUBS
MOYEURS DE ROUE
RADNABEN
СТУПИЦЫ КОЛЕС
BUJES DE RUEDA









EMMERRE
spare parts for trucks and trailers

ROR

| Applicazioni / Applications | Dettagli / Detail | Adattabile a / Adaptable to | Emmerre |
|--|---|-----------------------------|-----------------|
| TE 9000 9 ton | <ul style="list-style-type: none"> - Mozzo Ruota Technobrake/ <i>Technobrake wheel hub</i> - Mozzo ruota/<i>Wheel hub</i> - Senza cuscinetti/<i>Without bearings</i> | 21219784 212211625 | 931503/N |
| Connessione / Connected:  931396-931394  101538 | | | |
| TE 9000 9 ton | <ul style="list-style-type: none"> - Mozzo Ruota Technobrake/ <i>Technobrake wheel hub</i> - Mozzo ruota/<i>Wheel hub</i> - Con cuscinetti/<i>With bearings</i> - Con calotta/<i>With cover</i> | 14219784 | 931503 |
| Connessione / Connected:  931396-931394  101538  931535 | | | |
| Axle TE 9000 9 Ton | <ul style="list-style-type: none"> - Mozzo Ruota Technobrake/ <i>Technobrake wheel hub</i> - Mozzo ruota/<i>Wheel hub</i> - Con cuscinetti SKF/<i>With SKF bearings</i> - Con calotta O.E./<i>With O.E. cover</i> | 14219784 | 931524 |
| Connessione / Connected:  101538 | | | |



Mozzi Ruota
Wheel Hubs

| Emmerre | Adattabile a / Adaptable to | Dettagli / Detail | Applicazioni / Applications |
|---|-----------------------------|--|-----------------------------|
| 931508/N | 21226120 | <ul style="list-style-type: none"> - Mozzo Ruota Technobrake/ Technobrake wheel hub - Mozzo ruota/Wheel hub - Senza cuscinetti/Without bearings | Axle TA |
|  | | Connessione / Connected:  931075  101537 | |
| 931508 | 14226120 | <ul style="list-style-type: none"> - Mozzo Ruota Technobrake/ Technobrake wheel hub - Mozzo ruota/Wheel hub - Con cuscinetti/With bearings - Con calotta/With cover | Axle TA |
|  | | Connessione / Connected:  931075  101537  931537 | |
| 931528 | 14226120 | <ul style="list-style-type: none"> - Mozzo Ruota Technobrake/ Technobrake wheel hub - Mozzo ruota/Wheel hub - Con cuscinetti SKF/With SKF bearings - Con calotta O.E./With O.E. cover | Axle TA |
|  | | Connessione / Connected:  101537 | |





MOZZI RUOTA
WHEEL HUBS
MOYEURS DE ROUE
RADNABEN
СТУПИЦЫ КОЛЕС
BUJES DE RUEDA

EMMERRE
spare parts for trucks and trailers

ROR

| Applicazioni / Applications | Dettagli / Detail | Adattabile a / Adaptable to | Emmerre |
|---|---|-----------------------------|-----------------|
| Axle LM/LC | <ul style="list-style-type: none"> - Mozzo Ruota Technobrake/ <i>Technobrake wheel hub</i> - Mozzo ruota/<i>Wheel hub</i> - Senza cuscinetto/<i>Without bearing</i> | 14225494 | 931530/N |
| Connessione / Connected:  931420  101537 | | | |
| Axle LM/LC | <ul style="list-style-type: none"> - Mozzo Ruota Technobrake/ <i>Technobrake wheel hub</i> - Mozzo ruota/<i>Wheel hub</i> - Con cuscinetto/<i>With bearing</i> - Con calotta/<i>With cover</i> | 14225494 | 931530 |
| Connessione / Connected:  931534  101537  931420 | | | |
| Axle LM/LC | <ul style="list-style-type: none"> - Mozzo Ruota Technobrake/ <i>Technobrake wheel hub</i> - Mozzo ruota/<i>Wheel hub</i> - Con cuscinetti FAG/<i>With FAG bearings</i> - Con calotta O.E./<i>With O.E. cover</i> | 14225494 | 931531 |
| Connessione / Connected:  101537 | | | |











| Emmerre | Adattabile a / Adaptable to | Dettagli / Detail | Applicazioni / Applications |
|--|-----------------------------|---|-----------------------------|
| 931505/N | 21210885 | - Mozzo Ruota Technobrake/ <i>Technobrake wheel hub</i> - Senza cuscinetti/ <i>Without bearings</i> - Tamburo freno/ <i>Brake drum</i> mm. 420x180 | Axle TM |
| Connessione / Connected:  931075-931074  101537  931536 | | | |
| 931505 | 14210885 | - Mozzo Ruota Technobrake/ <i>Technobrake wheel hub</i> - Con cuscinetti/ <i>With bearings</i> - Tamburo freno/ <i>Brake drum</i> mm. 420x180 - Con calotta/ <i>With cover</i> | Axle TM |
| Connessione / Connected:  931075-931074  101537  931536 | | | |
| 931532 | 14210885 | - Mozzo Ruota Technobrake/ <i>Technobrake wheel hub</i> - Mozzo ruota/ <i>Wheel hub</i> - Con cuscinetti SKF/<i>With SKF bearings</i> - Con calotta O.E./<i>With O.E. cover</i> | Axle TM |
| Connessione / Connected:  101537 | | | |

MOZZI RUOTA
WHEEL HUBS
MOYEURS DE ROUE
RADNABEN
СТУПИЦЫ КОЛЕС
BUJES DE RUEDA

EMMERRE
spare parts for trucks and trailers

ROR

| Applicazioni / Applications | Dettagli / Detail | Adattabile a / Adaptable to | Emmerre |
|---|---|-----------------------------|-----------------|
| Axle TA | <ul style="list-style-type: none"> - Mozzo Ruota Technobrake/ <i>Technobrake wheel hub</i> - Senza cuscinetti/<i>Without bearings</i> - Ruote gemellate/<i>Twin wheels</i> | 21226121 | 931506/N |
|  | | | |
| Connessione / Connected:  931075  101537 | | | |
| Axle TA | <ul style="list-style-type: none"> - Mozzo Ruota Technobrake/ <i>Technobrake wheel hub</i> - Con cuscinetti/<i>With bearings</i> - Ruote gemellate/<i>Twin wheels</i> - Con calotta/<i>With cover</i> | 14226121 | 931506 |
|  | | | |
| Connessione / Connected:  931075  101537  931537 | | | |
| Axle TA | <ul style="list-style-type: none"> - Mozzo Ruota Technobrake/ <i>Technobrake wheel hub</i> - Mozzo ruota/<i>Wheel hub</i> - Con cuscinetti SKF/<i>With SKF bearings</i> - Con calotta O.E./<i>With O.E. cover</i> | 14226121 | 931527 |
|  | | | |
| Connessione / Connected:  101537 | | | |

Mozzi Ruota
Wheel Hubs





| Emmerre | Adattabile a / Adaptable to | Dettagli / Detail | Applicazioni / Applications |
|--|--|--|-------------------------------------|
| 931600   x12 pcs  | 100167600 3434365000 100167601 3200200151 4200200101 4200800100 | <ul style="list-style-type: none"> - Mozzo Ruota Technobrake/ Technobrake wheel hub - Mozzo ruota/Wheel hub - Con cuscinetti/With bearings - In acciaio/Steel material - Con colonnette/With bolts - Con ABS/With ABS | Axle SKRB 9019/9022 |
| Connessione / Connected:  960371-960362  931600.5  931600.4 | | | |
| 931605  | 1146200402 | <ul style="list-style-type: none"> - Mozzo Ruota Technobrake/ Technobrake wheel hub - Flangia fissaggio mozzo ruota/ Wheel hub fixing flange | Axle SKRB 9019/9022 |
| Connessione / Connected:  931600 | | | |
| 931617  | 1307106800 | <ul style="list-style-type: none"> - Mozzo Ruota Technobrake/ Technobrake wheel hub - Mozzo ruota/Wheel hub - Senza cuscinetti/Without bearings | Axles |
| 931599  | 1307112901 1307112900 | <ul style="list-style-type: none"> - Mozzo Ruota Technobrake/ Technobrake wheel hub - Mozzo ruota/Wheel hub - Senza cuscinetti/Without bearings | Axles RSM/10RLSM 9042-9042/20 |

MOZZI RUOTA
WHEEL HUBS
MOYEURS DE ROUE
RADNABEN
СТУПИЦЫ КОЛЕС
BUJES DE RUEDA

EMMERRE
spare parts for trucks and trailers

SAF

| Applicazioni / Applications | Dettagli / Detail | Adattabile a / Adaptable to | Emmerre |
|--|---|-----------------------------|-----------------|
| Axle JKRS JKRZ9042 | - Mozzo Ruota Technobrake/ <i>Technobrake wheel hub</i> - Mozzo ruota/ <i>Wheel hub</i> - Senza cuscinetti/ <i>Without bearings</i> | 3307300600 3307300300 | 931606/N |
|  | | | |
| Connessione / Connected:  931609 | | | |
| Axle JKRS JKRZ9042 | - Mozzo Ruota Technobrake/ <i>Technobrake wheel hub</i> - Mozzo ruota/ <i>Wheel hub</i> - Con cuscinetti/ <i>With bearings</i> - Con calotta/ <i>With cover</i> | 3307300600 3307300300 | 931606 |
|  | | | |
| Connessione / Connected:  931609  931607 | | | |
| Axle JKRS JKRZ9042 | - Mozzo Ruota Technobrake/ <i>Technobrake wheel hub</i> - Mozzo ruota/ <i>Wheel hub</i> - Con cuscinetti FAG/<i>With FAG bearings</i> - Con calotta/ <i>With cover</i> | 3307300600 3307300300 | 931616 |
|  | | | |
| Connessione / Connected:  931607 | | | |

| Emmerre | Adattabile a / Adaptable to | Dettagli / Detail | Applicazioni / Applications |
|--|--|---|--|
| 931612   | 3307303001 3307303000 3307303002 3307303003 | <ul style="list-style-type: none"> - Mozzo Ruota Technobrake/ <i>Technobrake wheel hub</i> - Mozzo ruota/<i>Wheel hub</i> - Con cuscinetti/<i>With bearings</i> - Con ABS/<i>With ABS</i> - Con calotta/<i>With cover</i> | Axle SKRB 9019/9022 Integral 19" 1/2 |
| | | Connessione / Connected:  931610  931624 | |
| 931630    | 3307303001 3307303000 3307303002 3307303003 | <ul style="list-style-type: none"> - Mozzo Ruota Technobrake/ <i>Technobrake wheel hub</i> - Mozzo ruota/<i>Wheel hub</i> - Con cuscinetti FAG/<i>With FAG bearings</i> - Con calotta/<i>With cover</i> - Con ABS/<i>With ABS</i> | Axle SKRB 9019/9022 Integral 19" 1/2 |
| | | Connessione / Connected:  931624 | |
| 931613   | 3307304500 3307304501 | <ul style="list-style-type: none"> - Mozzo Ruota Technobrake/ <i>Technobrake wheel hub</i> - Mozzo ruota/<i>Wheel hub</i> - Con cuscinetti/<i>With bearings</i> - Con ABS/<i>With ABS</i> - Con calotta/<i>With cover</i> | Axles BA9/B19 Generazione 6 |
| | | Connessione / Connected:  931608  931624 | |
| 931631    | 3307304500 3307304501 | <ul style="list-style-type: none"> - Mozzo Ruota Technobrake/ <i>Technobrake wheel hub</i> - Mozzo ruota/<i>Wheel hub</i> - Con cuscinetti FAG/<i>With FAG bearings</i> - Con calotta/<i>With cover</i> - Con ABS/<i>With ABS</i> | Axle Generazione 6 BA9/B19 |
| | | Connessione / Connected:  931624 | |

MOZZI RUOTA
WHEEL HUBS
MOYEURS DE ROUE
RADNABEN
СТУПИЦЫ КОЛЕС
BUJES DE RUEDA

EMMERRE
spare parts for trucks and trailers

SAF

| Applicazioni / Applications | Dettagli / Detail | Adattabile a / Adaptable to | Emmerre |
|---|--|-----------------------------|---------------|
| Axle SKRZ 11037-10 Axles S9/S11 Z9/Z11 | - Mozzo Ruota Technobrake/ <i>Technobrake wheel hub</i> - Mozzo ruota/ <i>Wheel hub</i> - Senza cuscinetti/ <i>Without bearings</i> | 3307304300 3307304301 | 931604 |



| | |
|--------------------------|--|
| Connessione / Connected: |  931608 |
|--------------------------|--|

| | | | |
|--|---|--------------------------|---------------|
| Axle Generazione 6 S9/S11/Z9/Z11 | - Mozzo Ruota Technobrake/ <i>Technobrake wheel hub</i> - Mozzo ruota/ <i>Wheel hub</i> - Con cuscinetti/ <i>With bearings</i> - Con ABS/ <i>With ABS</i> - Con calotta/ <i>With cover</i> | 3307304300 3307304301 | 931615 |
|--|---|--------------------------|---------------|







| | | | |
|--------------------------|--|--|--|
| Connessione / Connected: |  931608 |  931132 |  931624 |
|--------------------------|--|--|--|

| | | | |
|--|---|--------------------------|---------------|
| Axle Generazione 6 S9/S11/Z9/Z11 | - Mozzo Ruota Technobrake/ <i>Technobrake wheel hub</i> - Mozzo ruota/ <i>Wheel hub</i> - Con cuscinetti FAG/<i>With FAG bearings</i> - Con calotta/ <i>With cover</i> - Con ABS/ <i>With ABS</i> | 3307304300 3307304301 | 931633 |
|--|---|--------------------------|---------------|



| | | |
|--------------------------|--|--|
| Connessione / Connected: |  931132 |  931624 |
|--------------------------|--|--|

| Emmerre | Adattabile a / Adaptable to | Dettagli / Detail | Applicazioni / Applications |
|--|--|---|--------------------------------|
| 931614 | 3307305600 3307305601 3307305602 3307305603 | - Mozzo Ruota Technobrake/ <i>Technobrake wheel hub</i> - Mozzo ruota/ <i>Wheel hub</i> - Con cuscinetti/ <i>With bearings</i> - Con ABS/ <i>With ABS</i> - Con calotta/ <i>With cover</i> | Axle SKRZ 11242 TK335/10 |
|  | | Connessione / Connected:  931608  931624 | |
| 931632 | 3307305600 3307305601 3307305602 3307305603 | - Mozzo Ruota Technobrake/ <i>Technobrake wheel hub</i> - Mozzo ruota/ <i>Wheel hub</i> - Con cuscinetti FAG/<i>With FAG bearings</i> - Con calotta/ <i>With cover</i> - Con ABS/ <i>With ABS</i> | Axle SKRZ 11242 TK335/10 |
|  | | Connessione / Connected:  931624 | |

MOZZI RUOTA
WHEEL HUBS
MOYEURS DE ROUE
RADNABEN
СТУПИЦЫ КОЛЕС
BUJES DE RUEDA

EMMERRE
spare parts for trucks and trailers

SAF

| Applicazioni / Applications | Dettagli / Detail | Adattabile a / Adaptable to | Emmerre |
|-----------------------------|--|-----------------------------|---------------|
| Axles SKRS 9030 | <ul style="list-style-type: none"> - Mozzo Ruota Technobrake/ <i>Technobrake wheel hub</i> - Mozzo ruota/<i>Wheel hub</i> - Con cuscinetti/<i>With bearings</i> - Con ABS/<i>With ABS</i> - Con calotta/<i>With cover</i> | 3307205600 | 931597 |











| | | |
|--------------------------|--|--|
| Connessione / Connected: |  931611 |  931623 |
|--------------------------|--|--|

| | | | |
|-------------------|---|------------|---------------|
| Axle SKRS 9030 | <ul style="list-style-type: none"> - Mozzo Ruota Technobrake/ <i>Technobrake wheel hub</i> - Mozzo ruota/<i>Wheel hub</i> - Con cuscinetti FAG/<i>With FAG bearings</i> - Con calotta/<i>With cover</i> - Con ABS/<i>With ABS</i> | 3307205600 | 931635 |
|-------------------|---|------------|---------------|



| | |
|--------------------------|--|
| Connessione / Connected: |  931623 |
|--------------------------|--|







Mozzi Ruota
Wheel Hubs

| Emmerre | Adattabile a / Adaptable to | Dettagli / Detail | Applicazioni / Applications |
|--|-----------------------------|--|-----------------------------|
| 931596 | 3307304600 3307304601 | <ul style="list-style-type: none"> - Mozzo Ruota Technobrake/ <i>Technobrake wheel hub</i> - Mozzo ruota/<i>Wheel hub</i> - Con cuscinetti/<i>With bearings</i> - Con ABS/<i>With ABS</i> - Con calotta/<i>With cover</i> | Axle SKRZ11037-10 |
| Connessione / Connected:  931595  931624  931152 | | | |
| 931636 | 3307304600 3307304601 | <ul style="list-style-type: none"> - Mozzo Ruota Technobrake/ <i>Technobrake wheel hub</i> - Mozzo ruota/<i>Wheel hub</i> - Con cuscinetti FAG/<i>With FAG bearings</i> - Con calotta O.E./<i>With O.E. cover</i> - Con ABS/<i>With ABS</i> | Axle SKRZ11037-10 |
| Connessione / Connected:  931152 | | | |
| 931598 | 3307116600 3307116601 | <ul style="list-style-type: none"> - Mozzo Ruota Technobrake/ <i>Technobrake wheel hub</i> - Mozzo ruota/<i>Wheel hub</i> - Con cuscinetti/<i>With bearings</i> - Con ABS/<i>With ABS</i> - Con calotta/<i>With cover</i> | Axle SK500 PLUS |
| Connessione / Connected:  931623  931075-931074  931161 | | | |
| 931634 | 3307116600 3307116601 | <ul style="list-style-type: none"> - Mozzo Ruota Technobrake/ <i>Technobrake wheel hub</i> - Mozzo ruota/<i>Wheel hub</i> - Con cuscinetti FAG/<i>With FAG bearings</i> - Con calotta/<i>With cover</i> - Con ABS/<i>With ABS</i> | Axle SK500 PLUS |
| Connessione / Connected:  931623  931161 | | | |

MOZZI RUOTA
WHEEL HUBS
MOYEURS DE ROUE
RADNABEN
СТУПИЦЫ КОЛЕС
BUJES DE RUEDA

EMMERRE
spare parts for trucks and trailers

SAF













| Applicazioni / Applications | Dettagli / Detail | Adattabile a / Adaptable to | Emmerre |
|--|---|-----------------------------|---------|
| Axle SKRS/Z90 110378F | <ul style="list-style-type: none"> - Mozzo Ruota Technobrake/ <i>Technobrake wheel hub</i> - Mozzo ruota/<i>Wheel hub</i> - Con cuscinetti/<i>With bearings</i> - Con calotta/<i>With cover</i> | 3307301000 | 931869 |
| Connessione / Connected:  931594  931625 | | | |
| Axle SKRS/790 110378F | <ul style="list-style-type: none"> - Mozzo Ruota Technobrake/ <i>Technobrake wheel hub</i> - Mozzo ruota/<i>Wheel hub</i> - Con cuscinetti FAG/<i>With FAG bearings</i> - Con calotta/<i>With cover</i> | 3307301000 | 931637 |
| Connessione / Connected:  931625 | | | |
| Axle SK500 | <ul style="list-style-type: none"> - Mozzo Ruota Technobrake/ <i>Technobrake wheel hub</i> - Mozzo ruota/<i>Wheel hub</i> - Con cuscinetti/<i>With bearings</i> - Con ABS/<i>With ABS</i> - Con calotta/<i>With cover</i> | 3307115900 | 931870 |
| Connessione / Connected:  931611  931623 | | | |
| Axle SK500 | <ul style="list-style-type: none"> - Mozzo Ruota Technobrake/ <i>Technobrake wheel hub</i> - Mozzo ruota/<i>Wheel hub</i> - Con cuscinetti FAG/<i>With FAG bearings</i> - Con calotta/<i>With cover</i> - Con ABS/<i>With ABS</i> | 3307115900 | 931638 |
| Connessione / Connected:  931623 | | | |

EMMERRE

spare parts for trucks and trailers

SCANIA

MOZZI RUOTA
WHEEL HUBS
MOYEURS DE ROUE
RADNABEN
СТУПИЦЫ КОЛЕС
BUJES DE RUEDA

| Emmerre | Adattabile a / Adaptable to | Dettagli / Detail | Applicazioni / Applications |
|--|--|--|-----------------------------|
| 931801  | 1480933 1724406 1868663 1864430 | - Mozzo ruota anteriore/ <i>Front wheel hub</i> - Senza cuscinetto/ <i>Without bearing</i> | Serie 4 |
| Connessione / Connected:  960052  931818 | | | |
| 931808   | 1480933 1724406 1868663 1864430 | - Mozzo ruota anteriore/ <i>Front wheel hub</i> - Con cuscinetto/ <i>With bearing</i> - Con ABS/ <i>With ABS</i> | Serie 4 |
| Connessione / Connected:  960052  931818  931126 | | | |
| 931838    | 1480933 1724406 1868663 1864430 | - Mozzo ruota anteriore/ <i>Front wheel hub</i> - Con cuscinetto SKF/<i>With SKF bearing</i> - Con ABS/ <i>With ABS</i> | Serie 4 |
| Connessione / Connected:  960052  931126 | | | |

MOZZI RUOTA
WHEEL HUBS
MOYEURS DE ROUE
RADNABEN
СТУПИЦЫ КОЛЕС
BUJES DE RUEDA

EMMERRE
spare parts for trucks and trailers

SCANIA

| Applicazioni / Applications | Dettagli / Detail | Adattabile a / Adaptable to | Emmerre |
|--|---|-----------------------------|---------------|
| Serie 4 | - Mozzo ruota posteriore/Rear wheel hub - Senza cuscinetti/Without bearings | 1382884 | 931800 |
|  | | | |
| Connessione / Connected:  960052  931075 | | | |
| Serie 4 | - Mozzo ruota posteriore/Rear wheel hub - Con cuscinetti/With bearings | 1382884 | 931804 |
|  | | | |
| Connessione / Connected:  960052  931075 | | | |
| Serie 4 | - Mozzo ruota posteriore/Rear wheel hub - Con cuscinetti SKF/ With SKF bearings | 1382884 | 931843 |
|  | | | |
| Connessione / Connected:  960052 | | | |



Mozzi Ruota
Wheel Hubs

| Emmerre | Adattabile a / Adaptable to | Dettagli / Detail | Applicazioni / Applications |
|--|--|---|-----------------------------|
| 931802  | 1414154 1371596 1382774 1403040 1724407 1868674 | - Mozzo ruota anteriore - posteriore/ <i>Front - Rear wheel hub</i> - Senza cuscinetto/ <i>Without bearing</i> | Serie 4 |
| Connessione / Connected:  931818 | | | |
| 931809   | 1414154 1371596 1382774 1403040 1724407 1868674 | - Mozzo ruota anteriore - posteriore/ <i>Front - Rear wheel hub</i> - Con cuscinetto/ <i>With bearing</i> | Serie 4 |
| Connessione / Connected:  931818 | | | |
| 931839    | 1414154 1371596 1382774 1403040 1724407 1868674 | - Mozzo ruota anteriore - posteriore/ <i>Front - Rear wheel hub</i> - Con cuscinetti SKF/ <i>With SKF bearings</i> | Serie 4 |

MOZZI RUOTA
WHEEL HUBS
MOYEURS DE ROUE
RADNABEN
СТУПИЦЫ КОЛЕС
BUJES DE RUEDA

EMMERRE
spare parts for trucks and trailers

SCANIA

| Applicazioni / Applications | Dettagli / Detail | Adattabile a / Adaptable to | Emmerre |
|---|---|-----------------------------|---------------|
| Serie 93 - 94 - 113 - 114 - 124 - 143 - 144 - 164 | - Mozzo ruota posteriore/Rear wheel hub - Senza cuscinetti/Without bearings | 1724788 | 931803 |
|  | | | |
| Connessione / Connected:  931075 | | | |
| Serie 93 - 94 - 113 - 114 - 124 - 143 - 144 - 164 | - Mozzo ruota posteriore/Rear wheel hub - Con cuscinetti/With bearings | 1724788 | 931805 |
|  | | | |
| Connessione / Connected:  931075 | | | |
| Serie 93 - 94 - 113 - 114 - 124 - 143 - 144 - 164 | - Mozzo ruota posteriore/Rear wheel hub - Con cuscinetti SKF/ With SKF bearings | 1724788 | 931844 |
|  | | | |

EMMERRE

spare parts for trucks and trailers

SCANIA





MOZZI RUOTA
WHEEL HUBS
MOYEURS DE ROUE
RADNABEN
СТУПИЦЫ КОЛЕС
BUJES DE RUEDA

| Emmerre | Adattabile a / Adaptable to | Dettagli / Detail | Applicazioni / Applications |
|---|-----------------------------|--|-----------------------------|
| 931806  | 2085471 2290532 | - Mozzo ruota anteriore/ <i>Front wheel hub</i> - Senza cuscinetto/ <i>Without bearing</i> | Serie 5 |
| Connessione / Connected:  931818 | | | |
| 931842  | 2085471 2290532 | - Mozzo ruota anteriore/ <i>Front wheel hub</i> - Con cuscinetto/ <i>With bearing</i> | Serie 5 |
| Connessione / Connected:  931818 | | | |
| 931847  | 2085471 2290532 | - Mozzo ruota anteriore/ <i>Front wheel hub</i> - Con cuscinetti SKF/ <i>With SKF bearings</i> | Serie 5 |

MOZZI RUOTA
WHEEL HUBS
MOYEURS DE ROUE
RADNABEN
СТУПИЦЫ КОЛЕС
BUJES DE RUEDA

EMMERRE
spare parts for trucks and trailers

SCANIA

| Applicazioni / Applications | Dettagli / Detail | Adattabile a / Adaptable to | Emmerre |
|---|---|-----------------------------|---------------|
| Trucks | - Mozzo ruota posteriore/Rear wheel hub - Senza cuscinetti/Without bearings | 1800283 2290542 | 931845 |
|  | | | |
| Connessione / Connected:  931075 | | | |
| Trucks | - Mozzo ruota posteriore/Rear wheel hub - Con cuscinetti/With bearings | 1800283 2290542 | 931841 |
|  | | | |
| Connessione / Connected:  931075 | | | |
| Trucks | - Mozzo ruota posteriore/Rear wheel hub - Con cuscinetti SKF/ With SKF bearings | 1800283 2290542 | 931846 |
|  | | | |

| Emmerre | Adattabile a / <i>Adaptable to</i> | Dettagli / <i>Detail</i> | Applicazioni / <i>Applications</i> |
|---|---|---|------------------------------------|
| <p>931600</p>  <p>x12 pcs</p> | <p>1002689 1003457</p> | <p>- Con cuscinetti/<i>With bearings</i> - In acciaio/Steel material - Con colonnette/<i>With bolts</i> - Con ABS/<i>With ABS</i></p> | <p>CargoBull</p> |
| | | <p>Connessione / <i>Connected:</i>  960371-960362-931600.5-931600.4</p> | |

MOZZI RUOTA
WHEEL HUBS
MOYEURS DE ROUE
RADNABEN
СТУПИЦЫ КОЛЕС
BUJES DE RUEDA

EMMERRE
spare parts for trucks and trailers

SMB

| Applicazioni / Applications | Dettagli / Detail | Adattabile a / Adaptable to | Emmerre |
|-----------------------------|---------------------------------------|-----------------------------|---------------|
| Acerbi Viberti | - Senza cuscinetti / Without bearings | 449444 M069034 | 931621 |



Mozzi Ruota
Wheel Hubs

Emmerre

Adattabile a / *Adaptable to*

Dettagli / *Detail*

Applicazioni / *Applications*

931300

125699112





- Mozzo ruota/*Wheel hub*
- Senza cuscinetti/*Without bearings*
- Assale sterzante/*Steering axle*
- Freno/*Brake* mm. 160
- Con colonnette/*With bolts*



MOZZI RUOTA
WHEEL HUBS
MOYEURS DE ROUE
RADNABEN
СТУПИЦЫ КОЛЕС
BUJES DE RUEDA

EMMERRE
spare parts for trucks and trailers

VOLVO























| Applicazioni / Applications | Dettagli / Detail | Adattabile a / Adaptable to | Emmerre |
|---|---|--|---------------|
| FL FE | - Mozzo ruota anteriore/ <i>Front wheel hub</i> - Con cuscinetti/ <i>With bearings</i> - Con ABS/ <i>With ABS</i> | 20764313 | 931068 |
| B10 - B12 B6 - B7 - B9 F10 - F12 - F16 FE - FH12 - FH16 FH16 II FL6 - FL10 - FL12 FM7 - FM9 - FM12 N10 - NH12 | - Mozzo ruota anteriore/ <i>Front wheel hub</i> - Con cuscinetti/ <i>With bearings</i> - Con ABS/ <i>With ABS</i> | 20550678 | 931487 |
| FH 12 FH 16 FL 6 FL 7 FM 10 FM 12 | - Mozzo ruota anteriore/ <i>Front wheel hub</i> - Con cuscinetti/ <i>With bearings</i> - Con ABS/ <i>With ABS</i> | 21024160 21024166 20534904 21024155 20518092 | 931422 |
| Connessione / Connected:  931423  951032  931129 | | | |
| FH 12 FH 16 FL 6 FL 7 FM 10 FM 12 | - Mozzo ruota anteriore/ <i>Front wheel hub</i> - Con cuscinetti FAG/<i>With FAG bearings</i> - Con ABS/ <i>With ABS</i> | 21024160 21024166 20534904 21024155 20518092 | 931455 |
| Connessione / Connected:  931129  951032 | | | |

EMMERRE

spare parts for trucks and trailers

VOLVO

MOZZI RUOTA
WHEEL HUBS
MOYEURS DE ROUE
RADNABEN
СТУПИЦЫ КОЛЕС
BUJES DE RUEDA

| Emmerre | Adattabile a / Adaptable to | Dettagli / Detail | Applicazioni / Applications |
|--|-----------------------------|--|-----------------------------|
| 931427   x10 pcs | 85114470 85111791 | - Mozzo ruota anteriore/ <i>Front wheel hub</i> - Con cuscinetti/ <i>With bearings</i> - Con colonnette/ <i>With bolts</i> - Con ABS/ <i>With ABS</i> | FM FH |
| Connessione / Connected:  960456-960370  951074  931423  931122 | | | |
| 931440   x10 pcs | 85114470 85111791 | - Mozzo ruota anteriore/ <i>Front wheel hub</i> - Con ABS/ <i>With ABS</i> - Con colonnette/ <i>With bolts</i> - Con cuscinetti FAG/<i>With FAG bearings</i> | FM FH |
| Connessione / Connected:  960456-960370  951074  931122 | | | |
| 931429   x10 pcs | 85111792 | - Mozzo ruota anteriore/ <i>Front wheel hub</i> - Con cuscinetti/ <i>With bearings</i> - Con ABS/ <i>With ABS</i> - Con colonnette/ <i>With bolts</i> | FM 9 FH 12 FH 16 |
| Connessione / Connected:  960456-960370  951075  931424  931120 | | | |
| 931441   x10 pcs | 85111792 | - Mozzo ruota anteriore/ <i>Front wheel hub</i> - Con ABS/ <i>With ABS</i> - Con colonnette/ <i>With bolts</i> - Con cuscinetti FAG/<i>With FAG bearings</i> | FM 9 FH 12 FH 16 |
| Connessione / Connected:  960456-960370  951075  931120 | | | |

MOZZI RUOTA
WHEEL HUBS
MOYEURS DE ROUE
RADNABEN
СТУПИЦЫ КОЛЕС
BUJES DE RUEDA

EMMERRE
spare parts for trucks and trailers

VOLVO

| Applicazioni / Applications | Dettagli / Detail | Adattabile a / Adaptable to | Emmerre |
|--|--|---|---|
| FM 9/12/7/10 FL 7 FH 12/16 | - Mozzo ruota anteriore/ <i>Front wheel hub</i> - Con cuscinetti/ <i>With bearings</i> - Con ABS/ <i>With ABS</i> - Con colonnette/ <i>With bolts</i> | 85111794 85105693 85114471 85101818 3092719 3988831 | 931432  EMMERRE MODIFICATION |
| Connessione / Connected:  960456-960370  951075  931423  931122 | | | |
| FM 9/12/7/10 FL 7 FH 12/16 | - Mozzo ruota anteriore/ <i>Front wheel hub</i> - Con ABS/ <i>With ABS</i> - Con colonnette/ <i>With bolts</i> - Con cuscinetti FAG/<i>With FAG bearings</i> | 85111794 85101818 85114471 3092719 3988831 85105693 | 931442  EMMERRE MODIFICATION |
| Connessione / Connected:  960456-960370  951075  933122 | | | |
| FH FM | - Mozzo ruota anteriore/ <i>Front wheel hub</i> - Con cuscinetti/ <i>With bearings</i> - Con ABS/ <i>With ABS</i> - Con colonnette/ <i>With bolts</i> | 85107749 85111789 21022433 20534900 | 931433  EMMERRE MODIFICATION |
| Connessione / Connected:  960456-960370  951074  931424  931120 | | | |
| FH FM | - Mozzo ruota anteriore/ <i>Front wheel hub</i> - Con ABS/ <i>With ABS</i> - Con cuscinetti FAG/<i>With FAG bearings</i> | 85107749 85111789 21022433 20534900 | 931443  EMMERRE MODIFICATION |
| Connessione / Connected:  960456-960370  951074  931120 | | | |

EMMERRE

spare parts for trucks and trailers

VOLVO

MOZZI RUOTA
WHEEL HUBS
MOYEURS DE ROUE
RADNABEN
СТУПИЦЫ КОЛЕС
BUJES DE RUEDA

| Emmerre | Adattabile a / Adaptable to | Dettagli / Detail | Applicazioni / Applications |
|---|-----------------------------|--|--------------------------------|
| 931426 x10 pcs x12 pcs | 85107753 | - Mozzo ruota posteriore/Rear wheel hub - Con cuscinetti/With bearings - Con ABS/With ABS - Con colonnette/With bolts | FM 9 FL 6 FH 12 FH 16 |
| Connessione / Connected: 960456-960370 951071 931425 931121 | | | |
| 931438 x10 pcs x12 pcs | 85107753 | - Mozzo ruota posteriore/Rear wheel hub - Con ABS/With ABS - Con colonnette/With bolts - Con cuscinetti FAG/ With FAG bearings | FM 9 FL 6 FH 12 FH 16 |
| Connessione / Connected: 960456-960370 951071 931121 | | | |
| 931431 x10 pcs x12 pcs | 85105696 85101841 | - Mozzo ruota posteriore/Rear wheel hub - Con cuscinetti/With bearings - Con ABS/With ABS - Con colonnette/With bolts | FM 9/12 FH 12/16 |
| Connessione / Connected: 960456-960370 951078 931425 931121 | | | |
| 931439 x10 pcs x12 pcs | 85105696 85101841 | - Mozzo ruota posteriore/Rear wheel hub - Con ABS/With ABS - Con colonnette/With bolts - Con cuscinetti FAG/ With FAG bearings | FM 9/12 FH 12/16 |
| Connessione / Connected: 960456-960370 951078 931121 | | | |

MOZZI RUOTA
WHEEL HUBS
MOYEURS DE ROUE
RADNABEN
СТУПИЦЫ КОЛЕС
BUJES DE RUEDA

EMMERRE
spare parts for trucks and trailers

VOLVO

| Applicazioni / Applications | Dettagli / Detail | Adattabile a / Adaptable to | Emmerre |
|--|---|--|---|
| FH 12 FH 16 FH FM | - Mozzo ruota posteriore/Rear wheel hub - Con cuscinetti/With bearings - Con ABS/With ABS | 21328181 20819804 20535207 21328177 20820402 | 931436 |
| Connessione / Connected:  931425  931121 | |  |  |

| | | | |
|---|--|--|--|
| FH 12 FH 16 FH FM | - Mozzo ruota posteriore/Rear wheel hub - Con cuscinetti FAG/With FAG bearings - Con ABS/With ABS | 21328181 20819804 20535207 21328177 20820402 | 931471 |
| Connessione / Connected:  931121 | |  |  NEWS |

| | | | |
|--|--|--|---|
| FE/FH FH12/16 FL10/12 FL6/7 FM FM 10/12/7/9 NH12 | - Mozzo ruota posteriore/Rear wheel hub - Con cuscinetti/With bearings - 24 Denti / 24 Teeth - Con ABS/With ABS | 85109244 85107752 | 931448 |
| Connessione / Connected:  931425  931121 | |  |  |

| | | | |
|---|--|--|---|
| FE/FH/FM FH12/16 FL10/12 FL6/7 FM 10/12/7/9 NH12 | - Mozzo ruota posteriore/Rear wheel hub - Con cuscinetti FAG/With FAG bearings - Con ABS/With ABS | 85109244 85107752 | 931486 |
| Connessione / Connected:  931121 | |  |  NEWS |



















I riferimenti indicati non sono originali ma perfettamente intercambiabili. I codici originali e le case costruttrici sono indicati a puro titolo informativo
The details described are not original but perfectly interchangeable. The original references and manufacturer names are given for information purposes only.

EMMERRE

spare parts for trucks and trailers

VOLVO

MOZZI RUOTA
WHEEL HUBS
MOYEURS DE ROUE
RADNABEN
СТУПИЦЫ КОЛЕС
BUJES DE RUEDA

| Emmerre | Adattabile a / Adaptable to | Dettagli / Detail | Applicazioni / Applications |
|--|----------------------------------|--|-----------------------------|
| 931449   | 20535244 20518053 21336856 | - Mozzo ruota/Wheel hub - Con cuscinetti/With bearings - Con ABS/With ABS | FM FMX |
| Connessione / Connected:  931425  931121 | | | |
| 931475   | 20535244 20518053 20535245 | - Mozzo ruota posteriore/Rear wheel hub - Con cuscinetti FAG/With FAG bearings - Con ABS/With ABS | FM FMX |
| Connessione / Connected:  931121 | | | |
| 931452   | 20517164 85104301 1078053 | - Mozzo ruota posteriore/Rear wheel hub - Con cuscinetti/With bearings - Con ABS/With ABS | FE FH FL FM NH |
| Connessione / Connected:  931425  951078  931121  960456 | | | |
| 931453   | 20517164 85104301 1078053 | - Mozzo ruota posteriore/Rear wheel hub - Con cuscinetti FAG/With FAG bearings - Con ABS/With ABS | FE FH FL FM NH |
| Connessione / Connected:  960456  951078  931121 | | | |

MOZZI RUOTA
WHEEL HUBS
MOYEURS DE ROUE
RADNABEN
СТУПИЦЫ КОЛЕС
BUJES DE RUEDA

EMMERRE
spare parts for trucks and trailers

VOLVO

| Applicazioni / Applications | Dettagli / Detail | Adattabile a / Adaptable to | | Emmerre |
|-----------------------------|---|---------------------------------|---------------------------------|---------------|
| FE FH FL FM NH | - Mozzo ruota posteriore/Rear wheel hub - Con cuscinetti/With bearings - Con ABS/With ABS | 20517952 20535231 3943982 | 20476519 20518054 3989896 | 931450 |



Connessione / Connected:  931425  931121

| | | | | |
|----------------------------|--|---------------------------------|---------------------------------|---------------|
| FE FH FL FM NH | - Mozzo ruota posteriore/Rear wheel hub - Con cuscinetti FAG/With FAG bearings - Con ABS/With ABS | 20517952 20535231 3943982 | 20476519 20518054 3989896 | 931451 |
|----------------------------|--|---------------------------------|---------------------------------|---------------|



Connessione / Connected:  931121

| | | | | |
|--------|---|----------------------------------|--|---------------|
| Trucks | - Mozzo ruota posteriore/Rear wheel hub - Con cuscinetti/With bearings | 20820420 20499882 20819822 | | 931107 |
|--------|---|----------------------------------|--|---------------|



Connessione / Connected:  931425  931121

| | | | | |
|--------|--|----------------------------------|--|---------------|
| Trucks | - Mozzo ruota posteriore/Rear wheel hub - Con cuscinetti FAG/With FAG bearings | 20820420 20499882 20819822 | | 931472 |
|--------|--|----------------------------------|--|---------------|



Connessione / Connected:  931121

I riferimenti indicati non sono originali ma perfettamente intercambiabili. I codici originali e le case costruttrici sono indicati a puro titolo informativo
The details described are not original but perfectly interchangeable. The original references and manufacturer names are given for information purposes only.

EMMERRE
spare parts for trucks and trailers

VOLVO

**MOZZI RUOTA
WHEEL HUBS
MOYEURS DE ROUE
RADNABEN
СТУПИЦЫ КОЛЕС
BUJES DE RUEDA**

Emmerre

Adattabile a / *Adaptable to*

Dettagli / *Detail*

Applicazioni / *Applications*

931445

3078007
1626992

- Mozzo ruota posteriore/*Rear wheel hub*
- Senza cuscinetti/*Without bearings*

FH12



Connessione / *Connected:*



931416-931417



101532



951026

CUSCINETTI
BEARINGS
ROULEMENTS
RADLAGERN
ПОДШИПНИКИ
RODAMIENTOS

EMMERRE
spare parts for trucks and trailers

BPW









| Applicazioni / Applications | Dettagli / Detail | Adattabile a / Adaptable to | Emmerre |
|--|---|---|---|
| Axle | - Esterno/External Ø mm. 80 - Interno/Internal Ø mm. 40 - Spessore/Thickness mm. 32 | 0264074000 | 931011   |
| Axle 14 Ton Maxx / Eco Max Eco / Eco Plus | - Esterno/External Ø mm. 170 - Interno/Internal Ø mm. 95 - Spessore/Thickness mm. 45,5 | 0264059500 0264102800 | 931099   |
| Axle 16 Ton EH/EHZ/HH/HHS Max HHZ/HHZ Maxx | - Esterno/External Ø mm. 200 - Interno/Internal Ø mm. 110 - Spessore/Thickness mm. 56 | 0264051100 0264101100 0264102600 | 931489   |
| H-R-SKM-SKH-SH NR-NM-NH KR-KM-KH | - Esterno/External Ø mm. 130 - Interno/Internal Ø mm. 80 - Spessore/Thickness mm. 38 | 0264102400 0264088000 0902640880 | 931394  |
| Connessione / Connected: |  931402-931404-931410-931503-931811-931393 |  931387 | |

| Emmerre | Adattabile a / Adaptable to | Dettagli / Detail | Applicazioni / Applications |
|--|---|--|-----------------------------|
| 931395  | 0264102300 | - Esterno/External Ø mm. 150 | Eco Maxx |
| | 0264089000 0264089200 | - Interno/Internal Ø mm. 90 - Spessore/Thickness mm. 45 | Eco Plus H R NR |
| Connessione / Connected:  931403-931408-931409-931398-931399-931418-931437-931383-931391-931392 | | Connessione / Connected:  931388-931389-931390 | |
| 931396  | 0264102500 | - Esterno/External Ø mm. 110 | Eco Maxx |
| | 0264065000 | - Interno/Internal Ø mm. 50 - Spessore/Thickness mm. 42,25 / 43,50 | Eco Plus H R |
| Connessione / Connected:  931393-931402-931404-931410-931503 | | Connessione / Connected:  931387 | |
| 931074  | 0264076500 | - Esterno/External Ø mm. 120 | Series H |
| | 0264102200 | - Interno/Internal Ø mm. 65 | KH |
| | 0264076700 | - Spessore/Thickness mm. 41 | KM |
| | 0264102900 | | KR NR R SH |
| Connessione / Connected:  931403-931408-931409-931418-931500-931504-931505-931392-931398-931399-931405-931437-931383-931391 | | Connessione / Connected:  931611-931388-931389-931390 | |
| 931388  | 0980106260 | - Kit revisione cuscinetti mozzo/ Bearings revision kit for wheel hub | Eco Plus 8-9 Ton |
| | Connessione / Connected:  931395-931074  101544 | | |

CUSCINETTI
BEARINGS
ROULEMENTS
RADLAGERN
ПОДШИПНИКИ
RODAMIENTOS

EMMERRE
spare parts for trucks and trailers

BPW

| Applicazioni / Applications | Dettagli / Detail | Adattabile a / Adaptable to | Emmerre |
|---|---|-----------------------------|---------------|
| Eco 6.5-9 Ton | - Kit revisione cuscinetti mozzo/ <i>Bearings revision kit for wheel hub</i> | 0980102720 | 931387 |
|  | | | |
| Connessione / Connected:  931394-931396 | | | |
| Axle 6,5-9 Ton Eco Plus 2 | - Kit revisione cuscinetti mozzo/ <i>Bearings revision kit for wheel hub</i> | 0980107340 | 931389 |
|  | | | |
| Connessione / Connected:  931395-931074  101544 | | | |
| Eco Plus H/K 10-12 Ton Eco Seal 10 TON | - Kit revisione cuscinetti mozzo/ <i>Bearings revision kit for wheel hub</i> | 0980107040 | 931390 |
|  | | | |
| Connessione / Connected:  931395-931074  101544 | | | |

| Emmerre | Adattabile a / Adaptable to | Dettagli / Detail | Applicazioni / Applications |
|---|--|--|--|
| 931051 | 1801592 | <ul style="list-style-type: none"> - Kit cuscinetti/Bearings kit - Esterno/External Ø mm. 125 - Interno/Internal Ø mm. 70 - Spessore/Thickness mm. 114 - Anteriore/Front | 75/85/65 CF XF 95/105 |
|  | | | Connessione / Connected:  931750 |
| 931052 | 1801594 | <ul style="list-style-type: none"> - Kit cuscinetti/Bearings kit - Esterno/External Ø mm. 148 - Interno/Internal Ø mm. 100 - Spessore/Thickness mm. 135 - Posteriore/Rear | CF 75/85 XF 95/105 LF 45/55 |
|  | | | Connessione / Connected:  931751-931752 |
| 931080 | 931080 | <ul style="list-style-type: none"> - Posteriore/Rear - Esterno/External Ø mm. 156 - Interno/Internal Ø mm. 100 - Spessore/Thickness mm. 135 | CF 75/85 XF 95/105 LF 45/55 |
|  | | | |
|  | | | |
| 931396 | 0626875 0556289 0692180 1489090 | <ul style="list-style-type: none"> - Esterno/External Ø mm. 110 - Interno/Internal Ø mm. 50 - Spessore/Thickness mm. 42,25 / 43,50 | CF 65/75/85 XF 95 LF 55 |
|  | | | Connessione / Connected:  931393-931402-931404-931410-931503  931387 |

CUSCINETTI
BEARINGS
ROULEMENTS
RADLAGERN
ПОДШИПНИКИ
RODAMIENTOS

EMMERRE
spare parts for trucks and trailers

DAF

| Applicazioni / Applications | Dettagli / Detail | Adattabile a / Adaptable to | Emmerre |
|---|---|--|---------------|
| CF 75/85 XF 105/95 LF 55/45 | - Kit cuscinetti/Bearings kit - Esterno/External Ø mm. 124,70 / 119,70 - Interno/Internal Ø mm. 70 - Spessore/Thickness mm. 110 - Anteriore/Front | 1801595 | 931093 |
|  | | | |
| Connessione / Connected: 931753 | | | |
| XF 105/95 CF 75/85 | - Kit cuscinetti/Bearings kit - Esterno/External Ø mm. 138 - Interno/Internal Ø mm. 82 - Spessore/Thickness mm. 130 - Anteriore/Front | 1801593 | 931077 |
|  | | | |
| Connessione / Connected: 931755 | | | |
| LF 45 F1000 | - Esterno/External Ø mm. 62 - Interno/Internal Ø mm. 30 - Spessore/Thickness mm. 21,25 | 1400078 1344221 0491899 0164670 | 931053 |
| LF 55 | - Esterno/External Ø: mm. 160 - Interno/Internal Ø: mm. 90 - Spessore/Thickness: mm. 125 - Posteriore/Rear | 1400291 1408086 1705686 | 931057 |

| Emmerre | Adattabile a / Adaptable to | Dettagli / Detail | Applicazioni / Applications |
|--|-----------------------------|--|-----------------------------|
| 931075 | 0867621 1489085 | - Esterno/External Ø mm. 147 - Interno/Internal Ø mm. 90 - Spessore/Thickness mm. 40 | F 1500 |
|  | | | |
| 931417 | 0174592 | - Esterno/External Ø mm. 146,05 - Interno/Internal Ø mm. 82,55 - Spessore/Thickness mm. 41,28 - Lato esterno/External side - Posteriore/Rear | CF 75/85 XF 95 |
|  | | | |
| Connessione / Connected:  | | | 931419 |
| 931416 | 0174595 0682975 | - Esterno/External Ø mm. 168,28 - Interno/Internal Ø mm. 95,25 - Spessore/Thickness mm. 41,28 - Lato interno/Internal side - Posteriore/Rear | CF 75/85 XF 95 |
|  | | | |
| Connessione / Connected:  | | | 931419 |
| 931419 | 931419 | - Kit revisione completo/ Complete kit revision | CF 75/85 XF 95 |
|  | | | |
| Connessione / Connected:  | | | 931416-931417 |

CUSCINETTI
BEARINGS
ROULEMENTS
RADLAGERN
ПОДШИПНИКИ
RODAMIENTOS

EMMERRE
spare parts for trucks and trailers

DAF

| Applicazioni / Applications | Dettagli / Detail | Adattabile a / Adaptable to | Emmerre |
|---|--|-------------------------------|---|
| 85CF 95XF | - Esterno/External Ø mm. 80 - Interno/Internal Ø mm. 40 - Spessore/Thickness mm. 32 | 0738458 1197998 1602391 | 931011 |
| | | |  |
| LF55 XK105 95XF CF75/85/65 85FAD/FAR/FAT 85FT/FTG/FTT 95FA/FAC/FAD/FAR FAT/FT/FTG | - Esterno/External Ø mm. 145 - Interno/Internal Ø mm. 95 - Spessore/Thickness mm. 41 | 0676987 528430 | 930996 |
| | | |  |
| Connessione / Connected:  931754 | | | |
| Trucks | - Esterno/External Ø mm. 115 - Interno/Internal Ø mm. 75 - Spessore/Thickness mm. 26 | 635584 | 931091 |
| | | |  |
| 95XF 75CF/85CF 75FAT/FAV/FT 85FA/FAD/FAR FAG/FAT/FT FTG/FTT 95FA/FAC/FAG FAR/FAK/FAT | - Esterno/External Ø mm. 120 - Interno/Internal Ø mm. 55 - Spessore/Thickness mm. 46 | 0275823 0275828 | 930994 |
| | | |  |



Mozzi Ruota
Wheel Hubs

| Emmerre | Adattabile a / Adaptable to | Dettagli / Detail | Applicazioni / Applications |
|---|-----------------------------|--|-----------------------------|
| 931083   | 1672507 | - Esterno/External Ø mm. 180 - Interno/Internal Ø mm. 120 - Spessore/Thickness mm. 39,90 | Trucks |
| 931086   | 1703859 | - Esterno/External Ø mm. 130 - Interno/Internal Ø mm. 78 - Spessore/Thickness mm. 90 | LF45 |
| 931394   | 0836586 1489089 | - Esterno/External Ø mm. 130 - Interno/Internal Ø mm. 80 - Spessore/Thickness mm. 38 | Trucks |
| 931609   | 881002 | - Esterno/External Ø mm. 175 - Interno/Internal Ø mm. 120 - Spessore/Thickness mm. 123 | Trucks |







CUSCINETTI
BEARINGS
ROULEMENTS
RADLAGERN
ПОДШИПНИКИ
RODAMIENTOS

EMMERRE
spare parts for trucks and trailers

DAF

| Applicazioni / Applications | Dettagli / Detail | Adattabile a / Adaptable to | Emmerre |
|--|--|-----------------------------|--|
| 95FA/FAC/FAD/FAR F/FT/FTG/FTS/FTR FTT/SB | - Esterno/External Ø mm. 130 - Interno/Internal Ø mm. 70 - Spessore/Thickness mm. 57 | 20218627 260204 | 931378 |
| | | |  |
| Trucks | - Esterno/External Ø mm. 140 - Interno/Internal Ø mm. 90 - Spessore/Thickness mm. 32 | 77060 | 931162 |
| | | |  |
| | | | |
| | | | |





Mozzi Ruota
Wheel Hubs

| Emmerre | Adattabile a / Adaptable to | Dettagli / Detail | Applicazioni / Applications |
|---|---|--|--|
| 931009 | 26800140 93804619 7164502 8560451 93806251 503644293 | - Lato interno/Internal side - Esterno/External Ø mm. 80 - Interno/Internal Ø mm. 40 - Spessore/Thickness mm. 25 | New Daily 35.10 |
|  | | | Connessione / Connected:  931005 |
| 931010 | 26800330 93803935 503644294 | - Lato esterno/External side - Esterno/External Ø mm. 62 - Interno/Internal Ø mm. 25 - Spessore/Thickness mm. 18,40 | New Daily 35.10 |
|  | | | Connessione / Connected:  931005 |
| 931053 | 1110000 86010506 1905272 | - Esterno/External Ø mm. 62 - Interno/Internal Ø mm. 30 - Spessore/Thickness mm. 21,25 | New Daily |
|  | | | |
| 931014 | 7187566 7180066 46393024 503645071 503643937 | - Posteriore/Rear - Esterno/External mm. Ø 90 - Interno/Internal Ø mm. 55 - Spessore/Thickness mm. 60 | Daily Restyling 35/40/45 New Daily 49.10/12 New Daily '96 35/40/50 Turbodaily C10/12/14 Turbodaily '96 15/17/9 S9/11/13 |
|  | | | Connessione / Connected:  931007-931008-931142-931143 |

CUSCINETTI
BEARINGS
ROULEMENTS
RADLAGERN
ПОДШИПНИКИ
RODAMIENTOS

EMMERRE
spare parts for trucks and trailers

IVECO

| Applicazioni / Applications | Dettagli / Detail | Adattabile a / Adaptable to | Emmerre |
|--|---|-----------------------------|---------------|
| New Daily Turbodaily | - Lato interno/ <i>Internal side</i> - Esterno/ <i>External</i> Ø mm. 80 - Interno/ <i>Internal</i> Ø mm. 40 - Spessore/ <i>Thickness</i> mm. 32 | 8582739 1905261 | 931011 |
|  Connessione / Connected: 931006 | | | |
| New Daily Turbodaily | - Lato esterno/ <i>External side</i> - Esterno/ <i>External</i> Ø mm. 62 - Interno/ <i>Internal</i> Ø mm. 30 - Spessore/ <i>Thickness</i> mm. 25 | 8582740 503473270 | 931012 |
|  Connessione / Connected: 931006 | | | |
| Daily City 2000 | - Anteriore/ <i>Front</i> - Esterno/ <i>External</i> Ø mm. 73 - Interno/ <i>Internal</i> Ø mm. 40 - Spessore/ <i>Thickness</i> mm. 55 | 503642698 93825736 | 931015 |
|  Connessione / Connected: 931000-931001 | | | |
| Daily City 2000 Daily '96 | - Anteriore/ <i>Front</i> - Esterno/ <i>External</i> Ø mm. 68 - Interno/ <i>Internal</i> Ø mm. 35 - Spessore/ <i>Thickness</i> mm. 50 | 1861887 | 931020 |
|  Connessione / Connected: 931002 | | | |











EMMERRE

spare parts for trucks and trailers

IVECO

CUSCINETTI
BEARINGS
ROULEMENTS
RADLAGERN
ПОДШИПНИКИ
RODAMIENTOS

| Emmerre | Adattabile a / Adaptable to | Dettagli / Detail | Applicazioni / Applications |
|---|--|---|--|
| 931018 | 1905220 7172773 7172774 42471151 7172775 | - Esterno/External Ø mm. 121,40 - Interno/Internal Ø mm. 77,60 - Spessore/Thickness mm. 24 | Daily City 2000 Turbodaily Eurocargo Eurocargo Tector |
|  | Connessione / Connected:  931017-931039-930979-931144 | | |
| 931079 | 1905220 7172773 7172774 SET1293 | - Esterno/External Ø mm. 121,40 - Interno/Internal Ø mm. 77,60 - Spessore/Thickness mm. 24 - Cuscinetto Timken/Timken bearing | Daily City 2000 Turbodaily Eurocargo Eurocargo Tector |
|  | Connessione / Connected:  931017-931039 | | |
| 931021 | BTH1053 | - Anteriore/Front - Esterno/External Ø mm. 88 - Interno/Internal Ø mm. 45 - Spessore/Thickness mm. 55 | Daily City 2000 |
|  | Connessione / Connected:  931019 | | |
| 931022 | 504288649 | - Anteriore/Front - Esterno/External Ø mm. 73 - Interno/Internal Ø mm. 40 - Spessore/Thickness mm. 55 | Daily City 2000 |
|  | Connessione / Connected:  931025-931511-931109 | | |

CUSCINETTI
BEARINGS
ROULEMENTS
RADLAGERN
ПОДШИПНИКИ
RODAMIENTOS

EMMERRE
spare parts for trucks and trailers

IVECO

| Applicazioni / Applications | Dettagli / Detail | Adattabile a / Adaptable to | Emmerre |
|--|--|--|---------------|
| Daily City 2009 | - Posteriore/Rear - Esterno/External Ø mm. 90 - Interno/Internal Ø mm. 55 - Spessore/Thickness mm. 55 | 500054867 2996026 7186311 7188164 46393023 | 930998 |
| Daily 2006/2007 29L 10/11/12/13/14/9 35C12/14/17 35S10/11/13/9 | - Posteriore/Rear - Esterno/External Ø mm. 84 - Interno/Internal Ø mm. 49 - Spessore/Thickness mm. 48 | 42471033 2991641 7182301 | 931160 |
| Eurocargo Eurocargo Tector | - Esterno/External Ø 75 mm. - Interno/Internal Ø 45 mm. - Spessore/Thickness 20 mm. | 1905221 7173042 7173043 7173044 | 931054 |
| Connessione / Connected:  931029-931033-931046-931104 | | | |
| Eurocargo Eurocargo Tector | - Esterno/External Ø mm. 85 - Interno/Internal Ø mm. 45 - Spessore/Thickness mm. 32 | 1905222 7173751 7173752 6173753 7189272 | 931055 |
| Connessione / Connected:  931033-931046-931104 | | | |



| Emmerre | Adattabile a / Adaptable to | Dettagli / Detail | Applicazioni / Applications |
|--|---|---|-----------------------------|
| 931056 | 1905236 7172894 7172895 7172896 7165686 | - Esterno/External Ø mm. 100 - Interno/Internal Ø mm. 55 - Spessore/Thickness mm. 35 | Eurocargo |
|  | | | |
| Connessione / Connected:  | | | 931036-931048 |
| 931395 | 42103253 7174945 | - Esterno/External Ø mm. 150 - Interno/Internal Ø mm. 90 - Spessore/Thickness mm. 45 | Eurocargo |
|  | | | |
| 931086 | 7182915 7181863 | - Posteriore/Rear - Esterno/External Ø mm. 130 - Interno/Internal Ø mm. 78 - Spessore/Thickness mm. 90 | Eurocargo |
|  | | | |
| 931420 | 2994058 7184080 7184079 | - Esterno/External Ø mm. 140 - Interno/Internal Ø mm. 82 - Spessore/Thickness mm. 110 | Eurocargo |
|  | | | |







CUSCINETTI
BEARINGS
ROULEMENTS
RADLAGERN
ПОДШИПНИКИ
RODAMIENTOS

EMMERRE
spare parts for trucks and trailers

IVECO

| Applicazioni / Applications | Dettagli / Detail | Adattabile a / Adaptable to | Emmerre |
|--|--|---|---------------|
| Eurocargo Eurotrakker | - Esterno/External Ø mm. 145 - Interno/Internal Ø mm. 95 - Spessore/Thickness mm. 41 | 1104923 | 930996 |
|  Connessione / Connected: 931037-930991 | | | |
| Eurocargo | - Esterno/External Ø mm. 115 - Interno/Internal Ø mm. 75 - Spessore/Thickness mm. 26 | 1905219 1102042 1103141 | 931091 |
|  Connessione / Connected: 931035-930993 | | | |
| Eurocargo Turbostar | - Esterno/External Ø mm. 150 - Interno/Internal Ø mm. 85 - Spessore/Thickness mm. 38,50 | 1905172 7164544 | 931090 |
|  Connessione / Connected: 931045-931031 | | | |
| Eurocargo | - Esterno/External Ø mm. 160 - Interno/Internal Ø mm. 105 - Spessore/Thickness mm. 37,50 | 1104922 1905306 500143131 8190538 8193819 | 931087 |
|  Connessione / Connected: 931037-930991 | | | |



| Emmerre | Adattabile a / Adaptable to | Dettagli / Detail | Applicazioni / Applications |
|--|---|---|---------------------------------------|
| 931089 | 7166346 | - Esterno/External Ø mm. 120 - Interno/Internal Ø mm. 75 - Spessore/Thickness mm. 31 | Eurocargo |
|  | Connessione / Connected:  930992 | | |
| 931396 | 26800600 | - Esterno/External Ø mm. 110 - Interno/Internal Ø mm. 50 - Spessore/Thickness mm. 42,25 / 43,50 | 170 190 260 330 Turbostar |
|  | | | |
| 930995 | 4711928 4711927 | - Esterno/External Ø mm. 145 - Interno/Internal Ø mm. 75 - Spessore/Thickness mm. 51 | Turbostar Eurotech 190 |
|  | | | |
| Connessione / Connected:  931030-930985 | | | |
| 930994 | 26800610 1905114 1110021 | - Esterno/External Ø mm. 120 - Interno/Internal Ø mm. 55 - Spessore/Thickness mm. 46 | Turbostar Turbotech 190 |
|  | | | |
| Connessione / Connected:  931030-930985 | | | |

CUSCINETTI
BEARINGS
ROULEMENTS
RADLAGERN
ПОДШИПНИКИ
RODAMIENTOS

EMMERRE
spare parts for trucks and trailers

IVECO

| Applicazioni / Applications | Dettagli / Detail | Adattabile a / Adaptable to | Emmerre |
|-----------------------------|------------------------------|-----------------------------|--|
| Cursor | - Esterno/External Ø mm. 160 | 2996882 | 931057  |
| Eurocargo | - Interno/Internal Ø mm. 90 | 7183074 | |
| Eurostar | - Spessore/Thickness mm. 125 | 1905487 | |
| Eurotech | - Posteriore/Rear | 7179751 | |
| Stralis | | 7189050 7179749 | |

| Connessione / Connected: | |
|--|--|
|  931038-931043-930976 | |

| | | | |
|-----------|---------------------------------------|--------------------|---|
| Cursor | - Esterno/External Ø mm. 160 | 2996882 | 931078  |
| Eurocargo | - Interno/Internal Ø mm. 90 | 7183074 | |
| Eurostar | - Spessore/Thickness mm. 125 | 1905487 | |
| Eurotech | - Cuscinetto O.E./O.E. bearing | 7179751 | |
| Stralis | - Posteriore/Rear | 7189050 7179749 | |

| Connessione / Connected: | |
|--|--|
|  931038-931043-930974-931215-931216 | |

| | | | |
|-------------|-----------------------------------|---------|---|
| Eurocargo | - Kit cuscinetti/Bearings kit | 1905273 | 931064  |
| Eurostar | - Esterno/External Ø mm. 120//130 | | |
| Eurotech | - Interno/Internal Ø mm. 70/70 | | |
| Eurotrakker | - Spessore/Thickness mm. 37/43 | | |

| Connessione / Connected: | |
|--|--|
|  930977-930989-931084 | |

| | | | |
|-------------|--------------------------------|----------|--|
| Eurotrakker | - Esterno/External Ø mm. 180 | 1103360 | 931083  |
| Cursor | - Interno/Internal Ø mm. 120 | 42560422 | |
| Eurotech | - Spessore/Thickness mm. 39,90 | 38981836 | |
| Trakker | | | |

| Connessione / Connected: | |
|---|--|
|  930983-931040 | |

I riferimenti indicati non sono originali ma perfettamente intercambiabili. I codici originali e le case costruttrici sono indicati a puro titolo informativo
The details described are not original but perfectly interchangeable. The original references and manufacturer names are given for information purposes only.

EMMERRE

spare parts for trucks and trailers

IVECO

CUSCINETTI
BEARINGS
ROULEMENTS
RADLAGERN
ПОДШИПНИКИ
RODAMIENTOS

| Emmerre | Adattabile a / Adaptable to | Dettagli / Detail | Applicazioni / Applications |
|--|--------------------------------|---|---|
| 930997  | 1102864 1109972 26800090 | - Esterno/External Ø mm. 190 - Interno/Internal Ø mm. 105 - Spessore/Thickness mm. 41,30 | Eurotrakker Cursor Eurotech Trakker Eurocargo III Eurofire |
| Connessione / Connected:  930983-931040 | | | |
| 931162  | 7162944 1103228 | - Esterno/External Ø mm. 140 - Interno/Internal Ø mm. 90 - Spessore/Thickness mm. 32 | Trakker Eurotrakker Eurocargo I-III 330.30/330.36 |
| 931061  | 503126457 503623736 | - Kit cuscinetti/Bearings kit - Esterno/External Ø mm. 105 - Interno/Internal Ø mm. 160 - Spessore/Thickness mm. 140 | Trucks Irisbus/Citelis |
| 931094  | 7177004 26800270 | - Esterno/External Ø mm. 190 - Interno/Internal Ø mm. 105 - Spessore/Thickness mm. 54,90 | Eurostar Eurotech Turbostar Turbotech |
| Connessione / Connected:  930984-930987-931031-931042 | | | |

CUSCINETTI
BEARINGS
ROULEMENTS
RADLAGERN
ПОДШИПНИКИ
RODAMIENTOS

EMMERRE
spare parts for trucks and trailers

IVECO

| Applicazioni / Applications | Dettagli / Detail | Adattabile a / Adaptable to | Emmerre |
|---|---|---|---------------|
| Eurocargo Eurotech Trakker Eurostar | - Esterno/External Ø mm. 170 - Interno/Internal Ø mm. 95 - Spessore/Thickness mm. 45,50 | 7164543 1905350 26800250 3612949500 7178967 | 931099 |
| Trucks | - Esterno/External Ø mm. 130 - Interno/Internal Ø mm. 80 - Spessore/Thickness mm. 38 | 99041067 | 931394 |
| Daily | - Esterno/External Ø mm. 90 - Interno/Internal Ø mm. 55 - Spessore/Thickness mm. 54 - Con sensore magnetico/ With magnetic sensor | 5801564346 | 931488 |
| Daily 35/49.12 | - Esterno/External Ø mm. 90 - Interno/Internal Ø mm. 55 - Spessore/Thickness mm. 23 | 8169268 | 931174 |
| Connessione / Connected:  931007 | | | |



| Emmerre | Adattabile a / <i>Adaptable to</i> | Dettagli / <i>Detail</i> | Applicazioni / <i>Applications</i> |
|---|---|---|------------------------------------|
| 931053 | 06324990066 06324990080 | - Esterno/ <i>External</i> Ø mm. 62 - Interno/ <i>Internal</i> Ø mm. 30 - Spessore/ <i>Thickness</i> mm. 21,25 | G 90 M 90 |
|  | | | |
| 931011 | 06324890002 81934200077 81934200205 06324890043 | - Lato interno/ <i>Internal side</i> - Esterno/ <i>External</i> Ø mm. 80 - Interno/ <i>Internal</i> Ø mm. 40 - Spessore/ <i>Thickness</i> mm. 32 | M 90 |
|  | | | |
| 931012 | 06324990065 06324990175 06324990176 | - Lato esterno/ <i>External side</i> - Esterno/ <i>External</i> Ø mm. 62 - Interno/ <i>Internal</i> Ø mm. 30 - Spessore/ <i>Thickness</i> mm. 25 | M 90 |
|  | | | |
| 931396 | 06324903200 06324990034 06324990016 81440500074 81934200131 | - Esterno/ <i>External</i> Ø mm. 110 - Interno/ <i>Internal</i> Ø mm. 50 - Spessore/ <i>Thickness</i> mm. 42,25 / 43,50 | M 90 F 90 F 2000 |
|  | | | |

CUSCINETTI
BEARINGS
ROULEMENTS
RADLAGERN
ПОДШИПНИКИ
RODAMIENTOS

EMMERRE
spare parts for trucks and trailers

MAN

| Applicazioni / Applications | Dettagli / Detail | Adattabile a / Adaptable to | Emmerre |
|-----------------------------|--|---|---------------|
| TGA F 2000 | - Esterno/External \emptyset mm. 120 - Interno/Internal \emptyset mm. 65 - Spessore/Thickness mm. 41 | 06324890006 06324890046 81440500075 | 931074 |



| | | | |
|---|--|--|---------------|
| TGM TGS TGX TGA M/L 2000 Neoplan | - Esterno/External mm. \emptyset 160 - Interno/Internal \emptyset mm. 105 - Spessore/Thickness mm. 140 | 81934200342 81934200320 3694200009 81934200376 81934206097 | 931061 |
|---|--|--|---------------|



Connessione / Connected:  931101-931072

| | | | |
|------------|---|----------------------------|---------------|
| TGL TGM | - Esterno/External mm. \emptyset 82 - Interno/Internal \emptyset mm. 140 - Spessore/Thickness mm. 115 | 81934200354 81934200344 | 931059 |
|------------|---|----------------------------|---------------|



| | | | |
|----------------------|--|---|---------------|
| TGL TGM L 2000 | - Esterno/External mm. \emptyset 78 - Interno/Internal \emptyset mm. 130 - Spessore/Thickness mm. 90 | 81934200379 81934200332 81934206083 81934206099 81934206102 | 931086 |
|----------------------|--|---|---------------|



| Emmerre | Adattabile a / Adaptable to | Dettagli / Detail | Applicazioni / Applications |
|---|--|--|--|
| 931060  | 81934200346 81934200377 81934206098 | - Esterno/External Ø mm. 170 - Interno/Internal Ø mm. 110 - Spessore/Thickness mm. 146 | F 2000 TGA TGS TGX |
| Connessione / Connected:  | | | 931110-931112 |
| 930996   | 06324990036 06324990123 81934200185 87524601503 | - Esterno/External Ø mm. 145 - Interno/Internal Ø mm. 95 - Spessore/Thickness mm. 41 | TGA TGS E2000 F2000 M2000 F90 M90 NG/NL/NU/SU/UL |
| 931091   | 06324801000 | - Esterno/External Ø mm. 115 - Interno/Internal Ø mm. 75 - Spessore/Thickness mm. 26 | Trucks |
| 931087   | 06324890070 06324890071 06324890116 | - Esterno/External Ø mm. 160 - Interno/Internal Ø mm. 105 - Spessore/Thickness mm. 37,50 | TGA TGL TGM E2000 F2000 M2000 F90 M90 SL/SU/UL |

CUSCINETTI
BEARINGS
ROULEMENTS
RADLAGERN
ПОДШИПНИКИ
RODAMIENTOS

EMMERRE
spare parts for trucks and trailers

MAN

| Applicazioni / Applications | Dettagli / Detail | Adattabile a / Adaptable to | Emmerre |
|-----------------------------|--|---|---|
| F 2000 TGA TGS TGX | - Esterno/External Ø mm. 180 - Interno/Internal Ø mm. 120 - Spessore/Thickness mm. 39,90 | 06324801800 06324890063 81934200183 | 931083 |
| | | |  |
| Trucks | - Esterno/External Ø mm. 170 - Interno/Internal Ø mm. 95 - Spessore/Thickness mm. 45,50 | 06324990009 87523301400 06324901800 0023432219 | 931099 |
| | | |  |
| Trucks | - Esterno/External Ø mm. 130 - Interno/Internal Ø mm. 80 - Spessore/Thickness mm. 38 | 06324906400 | 931394 |
| | | |  |
| Trucks | - Esterno/External Ø mm. 150 - Interno/Internal Ø mm. 85 - Spessore/Thickness mm. 49 | 06324906600 | 931108 |
| | | |  |

Mozzi Ruota
Wheel Hubs

| Emmerre | Adattabile a / Adaptable to | Dettagli / Detail | Applicazioni / Applications |
|---|--|---|---|
| 931378   | 06324990043 06324990081 81934200074 | - Esterno/External Ø mm. 130 - Interno/Internal Ø mm. 70 - Spessore/Thickness mm. 57 | F 2000 L 2000 M 2000 NG/NL |
| 931380   | 06324990155 06324990044 06324990151 81934200103 87524601802 | - Esterno/External Ø mm. 170 - Interno/Internal Ø mm. 110 - Spessore/Thickness mm. 47 | TGA TGM TGS TGX E 2000 F 2000 M 2000 F90/M90 |
| 931979   | 06324890032 06324805000 06324850095 06324890050 64934200023 64934200024 64934200065 81934200090 0023431220 | - Esterno/External Ø mm. 180 - Interno/Internal Ø mm. 100 - Spessore/Thickness mm. 37 | TGA E 2000 F 2000 M 2000 F90 |
| 931162   | 06324890011 06324890051 | - Esterno/External Ø mm. 140 - Interno/Internal Ø mm. 90 - Spessore/Thickness mm. 32 | M 2000 L 2000 M90 |

CUSCINETTI
BEARINGS
ROULEMENTS
RADLAGERN
ПОДШИПНИКИ
RODAMIENTOS

EMMERRE
spare parts for trucks and trailers

MERCEDES

| Applicazioni / Applications | Dettagli / Detail | Adattabile a / Adaptable to | Emmerre |
|--|--|--|---------------|
| LK T2 | - Esterno/External Ø mm. 62 - Interno/Internal Ø mm. 30 - Spessore/Thickness mm. 21,25 | 0019816105 0019816505 0009813105 0079817605 | 931053 |
|  | | | |
| Atego Atego II | - Esterno/External Ø mm. 130 - Interno/Internal Ø mm. 78 - Spessore/Thickness mm. 90 | 0139819805 0139812205 0139812305 | 931086 |
|  | | | |
| Connessione / Connected:  931835-931823 | | | |
| Atego Atego II Axle Mercedes | - Esterno/External Ø mm. 140 - Interno/Internal Ø mm. 82 - Spessore/Thickness mm. 115 | 0169812805 0179815005 0149815105 0149819305 0149819905 | 931816 |
|  | | | |
| Connessione / Connected:  931832 | | | |
| Atego Atego II | - Lato interno/Inside - Esterno/External Ø mm. 80 - Interno/Internal Ø mm. 40 - Spessore/Thickness mm. 32 | 0039813905 0039817205 0049816805 0069816205 0089810105 0089817505 3849817605 | 931011 |
|  | | | |

| Emmerre | Adattabile a / Adaptable to | Dettagli / Detail | Applicazioni / Applications |
|---|--|---|--|
| 931012 | 0029810705 0029819105 0029819905 0109811505 | - Esterno/External - Esterno/External mm. \varnothing 62 - Interno/Internal \varnothing mm. 30 - Spessore/Thickness mm. 25 | Atego Atego II |
|  | | | |
| 931074 | 0039813705 0039817405 0069816305 0019800902 | - Esterno/External \varnothing mm. 120 - Interno/Internal \varnothing mm. 65 - Spessore/Thickness mm. 41 | Atego Atego II |
|  | | | |
| 931830 | 0159811905 9723300225 0149815705 | - Esterno/External \varnothing mm. 108 - Interno/Internal \varnothing mm. 60 - Spessore/Thickness mm. 75 | Actros MP2 Atego Atego II Axor II |
|  | | | |
| 931394 | 0129814005 0129814105 0179814905 | - Esterno/External \varnothing mm. 130 - Interno/Internal \varnothing mm. 80 - Spessore/Thickness mm. 38 | Actros Atego II Axor |
|  | | | |

Connessione / Connected:









931811-931814



CUSCINETTI
BEARINGS
ROULEMENTS
RADLAGERN
ПОДШИПНИКИ
RODAMIENTOS

EMMERRE
spare parts for trucks and trailers

MERCEDES

| Applicazioni / Applications | Dettagli / Detail | Adattabile a / Adaptable to | Emmerre |
|--|--|--|---|
| Actros MP2/MP3 Actros Atego | - Esterno/External Ø mm. 145 - Interno/Internal Ø mm. 75 - Spessore/Thickness mm. 51 | 0099817505 0099818105 | 930995   |
| Actros MP2/MP3 Actros Atego Axor II Axor SK/MK/NG T2L | - Esterno/External Ø mm. 120 - Interno/Internal Ø mm. 55 - Spessore/Thickness mm. 46 | 0069810805 0069816905 0069817405 0109819305 | 930994   |
| Connessione / Connected:  931840-931828 | | | |
| Trucks | - Esterno/External Ø mm. 180 - Interno/Internal Ø mm. 120 - Spessore/Thickness mm. 39,90 | 0029814605 0149814405 01498115405 | 931083   |
| T2L 0317 | - Esterno/External Ø mm. 170 - Interno/Internal Ø mm. 96 - Spessore/Thickness mm. 46,50 | 0009812105 000720032219 | 931099   |

Mozzi Ruota
Wheel Hubs

| Emmerre | Adattabile a / Adaptable to | Dettagli / Detail | Applicazioni / Applications |
|---|--|--|---|
| 931056   | 0049816405 0049816505 0049816705 0069816005 | - Esterno/External mm. Ø 100 - Interno/Internal Ø mm. 55 - Spessore/Thickness mm. 35 | NG LK LN2 LP 0301 0402 |
| 930996   | 0009809602 0029819005 0039818605 | - Esterno/External Ø mm. 145 - Interno/Internal Ø mm. 95 - Spessore/Thickness mm. 41 | Actros MP2/MP3 Actros Atego Axor II SK/MK NG/T2L |
| 931087   | 0039812505 003981250567 0039812705 0099819401 | - Esterno/External Ø mm. 160 - Interno/Internal Ø mm. 105 - Spessore/Thickness mm. 37,50 | Actros MP2/MP3 Actros Axor II Zetros SK/MK NG |
| 931089   | 0009807902 0039814705 0039814805 0089815305 | - Esterno/External Ø mm. 120 - Interno/Internal Ø mm. 75 - Spessore/Thickness mm. 31 | Trucks |

| Applicazioni / Applications | Dettagli / Detail | Adattabile a / Adaptable to | Emmerre |
|--|---|--|---------------|
| Actros Actros MP2 SK Axor MK/NG | - Esterno/External Ø mm. 150 - Interno/Internal Ø mm. 85 - Spessore/Thickness mm. 49 | 0079817005 0119810805 | 931108 |
|  | | | |
|  | | | |
| Connessione / Connected:  931840-931828 | | | |
| Actros Atego Antos Arocs Axor | - Esterno/External Ø mm. 150 - Interno/Internal Ø mm. 100 - Spessore/Thickness mm. 39 | 0059818405 0059818505 0069810105 | 931397 |
|  | | | |
|  | | | |
| Connessione / Connected:  931811-931814 | | | |
| Atego Axor II SK/MK/NG T2L Citaro Conecto Tourismo | - Esterno/External Ø mm. 130 - Interno/Internal Ø mm. 70 - Spessore/Thickness mm. 57 | 0049812305 0049813905 | 931378 |
|  | | | |
|  | | | |
| Actros MP4/MP2/MP3 Actros / Atego II Antos / Arocs Atego / Axor II Eco NSC/SK/MK/NG LK/LN2/T2L Citaro Travego Tourismo | - Esterno/External Ø mm. 170 - Interno/Internal Ø mm. 140 - Spessore/Thickness mm. 47 | 0049810705 0049810905 0059812105 0089813505 0189817105 | 931380 |
|  | | | |
|  | | | |

| Emmerre | Adattabile a / Adaptable to | Dettagli / Detail | Applicazioni / Applications |
|--|---|---|--|
| 931979  | 0007200302 000720030220 0049812105 0049814905 0079810005 | - Esterno/External mm. Ø 180 - Interno/Internal Ø mm. 100 - Spessore/Thickness mm. 37 | SK/MK/NG T2L |
| 931162  | 00720032018 0049811705 0049814305 004981430564 0059815605 0069810005 | - Esterno/External Ø mm. 140 - Interno/Internal Ø mm. 90 - Spessore/Thickness mm. 32 | Atego III Atego II Atego Unimog SK/MK/NG LK/LN2 |
| 931396  | 0019812905 0019817405 0019817605 0019808202 0069819905 | - Esterno/External Ø mm. 110 - Interno/Internal Ø mm. 50 - Spessore/Thickness mm. 42,25 / 43,50 | Actros Actros MP II Axor Citaro |
| 931092  | 0099814305 0119812305 0119813605 | - Esterno/External Ø mm. 157 - Interno/Internal Ø mm. 100 - Spessore/Thickness mm. 42 | Atego Axor II SK Actros MP2 Actros MP3 Actros MP4 |

CUSCINETTI
BEARINGS
ROULEMENTS
RADLAGERN
ПОДШИПНИКИ
RODAMIENTOS

EMMERRE
spare parts for trucks and trailers

MERCEDES

| Applicazioni / Applications | Dettagli / Detail | Adattabile a / Adaptable to | Emmerre |
|-----------------------------|--------------------------------|-----------------------------|---------------|
| Actros | - Esterno/External Ø mm. 130 | 0119816805 | 931812 |
| Actros MP2 | - Interno/Internal Ø mm. 60 | 0119815905 | |
| Axor | - Spessore/Thickness mm. 48,50 | 0159817505 | |
| Axor II | | | |



| | |
|--|--|
| Connessione / Connected:  931829-931825 | |
|--|--|

| | | | |
|------------|------------------------------|------------|---------------|
| Actros | - Esterno/External Ø mm. 150 | 0139814305 | 931813 |
| Actros MP2 | - Interno/Internal Ø mm. 70 | 0139814205 | |
| Axor | - Spessore/Thickness mm. 64 | 0099810805 | |
| Axor II | | 0099816405 | |



| | |
|--|--|
| Connessione / Connected:  931829-931825 | |
|--|--|

Mozi Ruota
Wheel Hubs

| Emmerre | Adattabile a / Adaptable to | Dettagli / Detail | Applicazioni / Applications |
|---|--|--|------------------------------|
| 931011 | 5000546524 5010136762 5010439056 5001830654 5010534037 | - Lato interno/Inside - Esterno/External Ø mm. 80 - Interno/Internal Ø mm. 40 - Spessore/Thickness mm. 32 | Midliner |
|  | | | |
| 931012 | 5010439054 | - Esterno/External - Esterno/External mm. Ø 62 - Interno/Internal Ø mm. 30 - Spessore/Thickness mm. 25 | Midliner Mascott |
|  | | | |
| 931074 | 5010368899 5010368900 5010439065 5000437786 5000437791 5000873122 5010067672 5010136769 | - Esterno/External Ø mm. 120 - Interno/Internal Ø mm. 65 - Spessore/Thickness mm. 41 | Midliner Mayor Manager |
|  | | | |
| 931425 | 7420792439 7421036050 7420518661 7420819859 7420819866 5001861915 7420516957 7420535264 7420819834 7420819846 | - Kit cuscinetti/Bearings kit - Esterno/External Ø mm. 148 - Interno/Internal Ø mm. 94 - Spessore/Thickness mm. 135 -- Posteriore/Rear | Magnum Premium Kerax |
|  | | | |

Connessione / Connected:



931426-931436-931431-931448-931449-931450-931452

CUSCINETTI
BEARINGS
ROULEMENTS
RADLAGERN
ПОДШИПНИКИ
RODAMIENTOS

EMMERRE
spare parts for trucks and trailers

RENAULT

| Applicazioni / Applications | Dettagli / Detail | Adattabile a / Adaptable to | Emmerre |
|---|---|--|---------------|
| Magnum | - Esterno/External Ø mm. 147 - Interno/Internal Ø mm. 90 - Spessore/Thickness mm. 40 | 23336108 | 931075 |
|  | | | |
| Magnum Premium | - Kit cuscinetti/Bearings kit - Esterno/External Ø mm. 110 - Interno/Internal Ø mm. 58 - Spessore/Thickness mm. 115 - Anteriore/Front | 7420518617 7421021381 7420967830 | 931424 |
|  | | | |
| Connessione / Connected:  931433-931429 | | | |
| Kerax Magnum Premium | - Kit cuscinetti/Bearings kit - Esterno/External Ø mm. 125 - Interno/Internal Ø mm. 68 - Spessore/Thickness mm. 115 - Anteriore/Front | 7420518637 7421021391 7420967831 | 931423 |
|  | | | |
| Connessione / Connected:  931427-931432-931422 | | | |
| Kerax Magnum | - Esterno/External Ø mm. 150 - Interno/Internal Ø mm. 90 - Spessore/Thickness mm. 42 | 5010587009 | 931103 |
|  | | | |

Mozi Ruota
Wheel Hubs

| Emmerre | Adattabile a / Adaptable to | Dettagli / Detail | Applicazioni / Applications |
|--|--|--|---------------------------------------|
| 931102 | 5010587010 5000785895 5010439571 5000785910 | - Esterno/External Ø mm. 160 - Interno/Internal Ø mm. 95 - Spessore/Thickness mm. 46 | Kerax Magnum |
|  931056 | 5010439061 | - Esterno/External Ø mm. 100 - Interno/Internal Ø mm. 55 - Spessore/Thickness mm. 35 | Midliner |
|  931083 | 7420853752 5000293585 | - Esterno/External Ø mm. 180 - Interno/Internal Ø mm. 120 - Spessore/Thickness mm. 39,90 | Trucks |
|  931053 | 7703090085 | - Esterno/External Ø mm. 62 - Interno/Internal Ø mm. 30 - Spessore/Thickness mm. 21,25 | Serie C Magnum Major Serie R |

CUSCINETTI
BEARINGS
ROULEMENTS
RADLAGERN
ПОДШИПНИКИ
RODAMIENTOS

EMMERRE
spare parts for trucks and trailers

RENAULT

| Applicazioni / Applications | Dettagli / Detail | Adattabile a / Adaptable to | Emmerre |
|--|---|--|---------------|
| Midlum Midliner | - Esterno/External Ø mm. 140 - Interno/Internal Ø mm. 90 - Spessore/Thickness mm. 32 | 5000254793 5010439301 | 931162 |
| Serie C Serie G Kerax Magnum Maxter Midlum Premium 2 | - Esterno/External Ø mm. 130 - Interno/Internal Ø mm. 60 - Spessore/Thickness mm. 48,50 | 5000682795 | 931812 |
| Trucks | - Esterno/External Ø mm. 170 - Interno/Internal Ø mm. 110 - Spessore/Thickness mm. 47 | 0959443022 | 931380 |
| Trucks | - Esterno/External Ø mm. 180 - Interno/Internal Ø mm. 100 - Spessore/Thickness mm. 37 | 0023430220 0023431220 0959130220 | 931979 |





Mozzi Ruota
Wheel Hubs

| Emmerre | Adattabile a / <i>Adaptable to</i> | Dettagli / <i>Detail</i> | Applicazioni / <i>Applications</i> |
|--|---|---|------------------------------------|
| <p>931099</p>  | <p>0023432219 0959232219 5000020632</p> | <p>- Esterno/<i>External</i> Ø mm. 170 - Interno/<i>Internal</i> Ø mm. 95 - Spessore/<i>Thickness</i> mm. 45,50</p> | <p>Trucks</p> |
| | | | |
| | | | |
| | | | |

CUSCINETTI
BEARINGS
ROULEMENTS
RADLAGERN
ПОДШИПНИКИ
RODAMIENTOS

EMMERRE
spare parts for trucks and trailers

ROR

| Applicazioni / Applications | Dettagli / Detail | Adattabile a / Adaptable to | Emmerre |
|---|---|-----------------------------|---------------|
| LM | - Esterno/External Ø mm. 140 - Interno/Internal Ø mm. 82 - Spessore/Thickness mm. 37,53 | 99041075 | 931076 |
|  Connessione / Connected: 931501-931502-931507 | | | |
| TE 9000 TE 9300 | - Esterno/External Ø mm. 130 - Interno/Internal Ø mm. 80 - Spessore/Thickness mm. 38 | 99041067B | 931394 |
|  Connessione / Connected: 931503 | | | |
| TM TMC | - Esterno/External Ø mm. 120 - Interno/Internal Ø mm. 65 - Spessore/Thickness mm. 41 | 99041045S | 931074 |
|  Connessione / Connected: 931500-931504-931505 | | | |
| TA TAC TM TMC | - Esterno/External Ø mm. 147 - Interno/Internal Ø mm. 90 - Spessore/Thickness mm. 40 | 99041035 | 931075 |
|  Connessione / Connected: 931500-931504-931505-931506-931508 | | | |





Mozi Ruota
Wheel Hubs

| Emmerre | Adattabile a / Adaptable to | Dettagli / Detail | Applicazioni / Applications |
|---|-----------------------------|--|-----------------------------|
| 931057 | A1228X1480 | - Esterno/External Ø mm. 160 - Interno/Internal Ø mm. 90 - Spessore/Thickness mm. 125 | Axle |
|  | | | |
| 931078 | A1228X1480 SET1242 | - Esterno/External Ø mm. 160 - Interno/Internal Ø mm. 90 - Spessore/Thickness mm. 125 - Cuscinetto Timken/Timken bearing | Axle |
|  | | | |
| 931087 | A1128F1540M | - Esterno/External Ø mm. 160 - Interno/Internal Ø mm. 105 - Spessore/Thickness mm. 37,50 | Axle |
|  | | | |
| 931396 | 99041068 | - Esterno/External Ø mm. 110 - Interno/Internal Ø mm. 50 - Spessore/Thickness mm. 42,25-43,50 | Axle |
|  | | | |

CUSCINETTI
BEARINGS
ROULEMENTS
RADLAGERN
ПОДШИПНИКИ
RODAMIENTOS

EMMERRE
spare parts for trucks and trailers

ROR

| Applicazioni / Applications | Dettagli / Detail | Adattabile a / Adaptable to | Emmerre |
|---|--|-----------------------------|--|
| Axle | - Esterno/External Ø mm. 180 - Interno/Internal Ø mm. 120 - Spessore/Thickness mm. 39,90 | A1128E1539M | 931083 |
| | | |  |
| 167E/147E | - Esterno/External Ø mm. 140 - Interno/Internal Ø mm. 82 - Spessore/Thickness mm. 110 | A1228Q1499 | 931420 |
| | | |  |
| Connessione / Connected:  931530 | | | |

| Emmerre | Adattabile a / Adaptable to | Dettagli / Detail | Applicazioni / Applications |
|--|--|--|--|
| 931609  | 3434301200 3434301000 3307301200 4200101601 4200101602 | - Kit cuscinetti/Bearings kit - Esterno/External Ø: mm. 175 - Interno/Internal Ø: mm. 120 - Spessore/Thickness: mm. 123 | Axle SKRS SKRZ |
| Connessione / Connected:  | | | 931606 |
| 931610  | 3434301800 | - Esterno/External Ø: mm. 138 - Interno/Internal Ø: mm. 82 - Spessore/Thickness: mm. 110 | Axle SKRB |
| Connessione / Connected:  | | | 931612 |
| 931395  | 4200100900 | - Esterno/External Ø: mm. 150 - Interno/Internal Ø: mm. 90 - Spessore/Thickness: mm. 45 | Axle RZM |
| 931074  | 4200006000 | - Esterno/External Ø mm. 120 - Interno/Internal Ø mm. 65 - Spessore/Thickness mm. 41 | Axle KRS-RBM-RLBM-RLSM RSM-RZM-SKRLZ SK-SKRS-SKRZ WRLZM-WRZM |
| Connessione / Connected:  | | | 931611 |

CUSCINETTI
BEARINGS
ROULEMENTS
RADLAGERN
ПОДШИПНИКИ
RODAMIENTOS

EMMERRE
spare parts for trucks and trailers

SAF

| Applicazioni / Applications | Dettagli / Detail | Adattabile a / Adaptable to | Emmerre |
|---|--|-----------------------------|---------------|
| Axle SKRS-SKRZ-KRS RBM-RLSM-RSM SK-SKRLZ WRLZM-WRZM | - Esterno/External Ø mm. 147 - Interno/Internal Ø mm. 90 - Spessore/Thickness mm. 40 | 4200100600 | 931075 |



| Connessione / Connected: | 931611 |
|--------------------------|--------|
|--------------------------|--------|

| | | | |
|--|--|--|---------------|
| Axle B9 BA9 BI9 S11 S9 Z9 Z11 | - Kit cuscinetti/Bearings kit - Esterno/External Ø mm. 138 - Interno/Internal Ø mm. 88 - Spessore/Thickness mm. 120 | 3434302000 3434301900 3434302200 3434302001 | 931608 |
|--|--|--|---------------|



| Connessione / Connected: | 931613-931615-931614-931604 |
|--------------------------|-----------------------------|
|--------------------------|-----------------------------|

| | | | |
|---|--|------------|---------------|
| Axle SKRS/RZ SKRZ KRS SKRLS | - Esterno/External Ø mm. 120/147 - Interno/Internal Ø mm. 65/90 - Spessore/Thickness mm. 41/40 - Kit revisione cuscinetti mozzo ruota/ Bearings revision kit for wheel hub | 3434301600 | 931611 |
|---|--|------------|---------------|



| Connessione / Connected: | 931597-931598-931870 | 931074-931075 |
|--------------------------|----------------------|---------------|
|--------------------------|----------------------|---------------|

| | | | |
|--------------------------|--|------------|---------------|
| KRZ - RZM RZT KRZT | - Cuscinetto/Bearing - Esterno/External Ø mm. 190 - Interno/Internal Ø mm. 105 - Spessore/Thickness mm. 54,90 | 4200002800 | 931094 |
|--------------------------|--|------------|---------------|





I riferimenti indicati non sono originali ma perfettamente intercambiabili. I codici originali e le case costruttrici sono indicati a puro titolo informativo
The details described are not original but perfectly interchangeable. The original references and manufacturer names are given for information purposes only.

| Emmerre | Adattabile a / <i>Adaptable to</i> | Dettagli / <i>Detail</i> | Applicazioni / <i>Applications</i> |
|--|------------------------------------|--|--|
| 931056  | 4200005800 | - Esterno/ <i>External</i> Ø: mm. 100 - Interno/ <i>Internal</i> Ø: mm. 55 - Spessore/ <i>Thickness</i> : mm. 35 | Axle EBN |
| 930994  | 4200003200 | - Esterno/ <i>External</i> Ø: mm. 120 - Interno/ <i>Internal</i> Ø: mm. 55 - Spessore/ <i>Thickness</i> : mm. 46 | Axle |
| 931083  | 4200101400 | - Esterno/ <i>External</i> Ø: mm. 180 - Interno/ <i>Internal</i> Ø: mm. 120 - Spessore/ <i>Thickness</i> : mm. 39,90 | Axle |
| 931099  | 4200002600 | - Esterno/ <i>External</i> Ø: mm. 170 - Interno/ <i>Internal</i> Ø: mm. 96 - Spessore/ <i>Thickness</i> : mm. 45,50 | Axle KRS KRZ KRZT RZM RZT |

CUSCINETTI
BEARINGS
ROULEMENTS
RADLAGERN
ПОДШИПНИКИ
RODAMIENTOS

EMMERRE
spare parts for trucks and trailers

SAF

| Applicazioni / Applications | Dettagli / Detail | Adattabile a / Adaptable to | Emmerre |
|---|--|-----------------------------|--|
| Axle RZM RZT | - Esterno/External \varnothing mm. 130 - Interno/Internal \varnothing mm. 60 - Spessore/Thickness mm. 48,50 | 4200003300 | 931812 |
| | | |  |
| Axle SKRS 9037 | - Esterno/External \varnothing mm. 148 - Interno/Internal \varnothing mm. 100 - Spessore/Thickness mm. 70,50 | 3434301100 | 931594 |
| | | |  |
| Connessione / Connected:  931869 | | | |

| Emmerre | Adattabile a / Adaptable to | Dettagli / Detail | Applicazioni / Applications |
|---|-----------------------------|---|-----------------------------|
| 931011 | 284843 | - Lato interno/ <i>Internal side</i> - Esterno/ <i>External</i> Ø mm. 80 - Interno/ <i>Internal</i> Ø mm. 40 - Spessore/ <i>Thickness</i> mm. 32 | Series 4 |
|  | | | |
| 931430 | 322748 1584340 | - Lato esterno/ <i>External side</i> Ø mm. 130 - Interno/ <i>Internal</i> Ø mm. 70 - Spessore/ <i>Thickness</i> mm. 43 | Series 3 Series 4 |
|  | | | |
| 931087 | 1415140 | - Esterno/ <i>External</i> Ø: mm. 160 - Interno/ <i>Internal</i> Ø: mm. 105 - Spessore/ <i>Thickness</i> : mm. 37,50 | Series K |
|  | | | |
| 930994 | 14764 178427 179427 | - Esterno/ <i>External</i> Ø: mm. 120 - Interno/ <i>Internal</i> Ø: mm. 55 - Spessore/ <i>Thickness</i> : mm. 46 | Series 2 |
|  | | | |

CUSCINETTI
BEARINGS
ROULEMENTS
RADLAGERN
ПОДШИПНИКИ
RODAMIENTOS

EMMERRE
spare parts for trucks and trailers

SCANIA

| Applicazioni / Applications | Dettagli / Detail | Adattabile a / Adaptable to | Emmerre |
|-----------------------------|---|--|---------------|
| Series 4 | - Esterno/External Ø mm. 127 - Interno/Internal Ø mm. 68 - Spessore/Thickness mm. 115 | 1439070 1443078 1476945 1868087 1724482 2310169 1382900 1413785 1336296 1356897 1365570 | 931818 |



Connessione / Connected:  931801-931802-931808-931809-931842-931806

| | | | |
|----------|------------------------------|------------------|---------------|
| Series 3 | - Esterno/External Ø mm. 147 | 1524625 | 931075 |
| Series 4 | - Interno/Internal Ø mm. 90 | 0291060 | |
| P.R.G.T. | - Spessore/Thickness mm. 40 | 183351 523907 | |



Connessione / Connected:  931800-931803-931804-931805-931841

| | | | |
|----------|--|---------|---------------|
| Series 4 | - Esterno/External Ø mm. 130 - Interno/Internal Ø mm. 80 - Spessore/Thickness mm. 38 | 1301694 | 931394 |
|----------|--|---------|---------------|



| | | | |
|----------|--|--------|---------------|
| Series 4 | - Esterno/External Ø mm. 62 - Interno/Internal Ø mm. 30 - Spessore/Thickness mm. 21,25 | 123631 | 931053 |
|----------|--|--------|---------------|



Connessione / Connected:  931803

I riferimenti indicati non sono originali ma perfettamente intercambiabili. I codici originali e le case costruttrici sono indicati a puro titolo informativo
The details described are not original but perfectly interchangeable. The original references and manufacturer names are given for information purposes only.

| Emmerre | Adattabile a / Adaptable to | Dettagli / Detail | Applicazioni / Applications |
|--|-----------------------------|---|-----------------------------|
| 931012  | 315288 | - Esterno/External Ø mm. 62 - Interno/Internal Ø mm. 30 - Spessore/Thickness mm. 25 | Trucks |
| 931812  | 1301675 14836 1911817 | - Esterno/External Ø mm. 130 - Interno/Internal Ø mm. 60 - Spessore/Thickness mm. 48,50 | Trucks |
| 931061  | 1850970 | - Esterno/External Ø mm. 160 - Interno/Internal Ø mm. 105 - Spessore/Thickness mm. 140 | Series 3 Series 4 |
| 931099  | 33948 | - Esterno/External Ø mm. 170 - Interno/Internal Ø mm. 95 - Spessore/Thickness mm. 45,50 | Trucks |

CUSCINETTI
BEARINGS
ROULEMENTS
RADLAGERN
ПОДШИПНИКИ
RODAMIENTOS

EMMERRE
spare parts for trucks and trailers

SCANIA

| Applicazioni / Applications | Dettagli / Detail | Adattabile a / Adaptable to | Emmerre |
|-----------------------------|--|-----------------------------|---------------|
| Series 4 P.G.R.T. | - Esterno/External \emptyset mm. 140 - Interno/Internal \emptyset mm. 90 - Spessore/Thickness mm. 32 | 1542748 | 931162 |



Mozzi Ruota
Wheel Hubs

| Emmerre | Adattabile a / Adaptable to | Dettagli / Detail | Applicazioni / Applications |
|---|-----------------------------|---|-----------------------------|
| 931394 | 012547 017062 | - Esterno/External Ø mm. 130 - Interno/Internal Ø mm. 80 - Spessore/Thickness mm. 38 | Axle |
|  | | | |
| 931395 | 014440 | - Esterno/External Ø mm. 150 - Interno/Internal Ø mm. 90 - Spessore/Thickness mm. 45 | Axle |
|  | | | |
| 931396 | 017704 | - Esterno/External Ø mm. 110 - Interno/Internal Ø mm. 50 - Spessore/Thickness mm. 42,25 / 43,50 | Axle |
|  | | | |
| 931074 | 010278 015052 | - Esterno/External Ø mm. 120 - Interno/Internal Ø mm. 65 - Spessore/Thickness mm. 41 | Axle |
|  | | | |

CUSCINETTI
BEARINGS
ROULEMENTS
RADLAGERN
ПОДШИПНИКИ
RODAMIENTOS

EMMERRE
spare parts for trucks and trailers

SCHMITZ

| Applicazioni / Applications | Dettagli / Detail | Adattabile a / Adaptable to | Emmerre |
|-----------------------------|--|-----------------------------|---------|
| Axle | - Esterno/External \varnothing mm. 147 - Interno/Internal \varnothing mm. 90 - Spessore/Thickness mm. 40 | 010277 | 931075 |







Mozzi Ruota
Wheel Hubs

| Emmerre | Adattabile a / Adaptable to | Dettagli / Detail | Applicazioni / Applications |
|--|---------------------------------|--|-----------------------------|
| 931057 | 10720825 10875658 | - Esterno/External Ø mm. 160 - Interno/Internal Ø mm. 90 - Spessore/Thickness mm. 125 | Series T Bus |
|  | | | |
| 931078 | 10720825 10875658 SET1242 | - Esterno/External Ø mm. 160 - Interno/Internal Ø mm. 90 - Spessore/Thickness mm. 125 - Cuscinetto Timken/Timken bearing | Series T Bus |
|  | | | |

CUSCINETTI
BEARINGS
ROULEMENTS
RADLAGERN
ПОДШИПНИКИ
RODAMIENTOS

EMMERRE
spare parts for trucks and trailers

VOLVO

| Applicazioni / Applications | Dettagli / Detail | Adattabile a / Adaptable to | Emmerre |
|--|--|---------------------------------------|---|
| FL 6 | - Esterno/External - Esterno/External Ø mm. 62 - Interno/Internal Ø mm. 30 - Spessore/Thickness mm. 25 | 183728 | 931012 |
| | | |  |
| FE-FL7-FL 6 N10-B10 | - Lato interno/Inside - Esterno/External Ø mm. 80 - Interno/Internal Ø mm. 40 - Spessore/Thickness mm. 32 | 1652127 184679 3094303 | 931011 |
| | | |  |
| FL 6/7/10 FH 12/16 FM 7/9/12 F 7/10/12/16 N10/NH12 B 7/9/12 | - Esterno/External Ø mm. 130 - Interno/Internal Ø mm. 70 - Spessore/Thickness mm. 43 | 8151816 1584340 | 931430 |
| | | |  |
| F 4 | - Esterno/External Ø mm. 62 - Interno/Internal Ø mm. 30 - Spessore/Thickness mm. 21,25 | 183583 7019553 19553 6601861 | 931053 |
| | | |  |

EMMERRE

spare parts for trucks and trailers

VOLVO

CUSCINETTI
BEARINGS
ROULEMENTS
RADLAGERN
ПОДШИПНИКИ
RODAMIENTOS

| Emmerre | Adattabile a / Adaptable to | Dettagli / Detail | Applicazioni / Applications |
|--|--|---|--|
| 931074 | 184672 1846724 | - Esterno/External Ø mm. 120 - Interno/Internal Ø mm. 65 - Spessore/Thickness mm. 41 | F 6 F 10 F 12 |
|  | | | |
| 931425 | 20518661 21036050 20967828 20792439 | - Kit cuscinetti/Bearings kit - Esterno/External Ø mm. 148 - Interno/Internal Ø mm. 94 - Spessore/Thickness mm. 135 - Posteriore/Rear | FE / FE11 FH / FH11/12/16 FM / FM7/9/10/12 FL / FL6/7/10 FMX / FMX11 NH12 B 7/9/12 |
|  | | | |
| Connessione / Connected:  931426-931431-931436-931448-931449-931450-931452-931107 | | | |
| 931075 | 1698580 183351 | - Esterno/External Ø mm. 147 - Interno/Internal Ø mm. 90 - Spessore/Thickness mm. 40 | FM 7/9/12 FH 12/16 FH16 II FL7/10 F10/12/16 N10 NH12 B10 |
|  | | | |
| 931424 | 20967830 20518617 21021381 | - Kit cuscinetti/Bearings kit - Esterno/External Ø mm. 110 - Interno/Internal Ø mm. 58 - Spessore/Thickness mm. 115 - Anteriore/Front | FM / FM9/12 FH / FH11/12/16 FE FH16 II |
|  | | | |
| Connessione / Connected:  931429-931433 | | | |

CUSCINETTI
BEARINGS
ROULEMENTS
RADLAGERN
ПОДШИПНИКИ
RODAMIENTOS

EMMERRE
spare parts for trucks and trailers

VOLVO

| Applicazioni / Applications | Dettagli / Detail | Adattabile a / Adaptable to | Emmerre |
|--|---|---|---------------|
| FM / FM7/9/12 FH / FH11/12/16 FL / FL6 FMX / FMX11 NH12 B9/12 | - Kit cuscinetti/Bearings kit - Esterno/External Ø mm. 125 - Interno/Internal Ø mm. 68 - Spessore/Thickness mm. 115 - Anteriore/Front | 20967831 20518637 3988673 21021391 | 931423 |



Connessione / Connected:  931422-931427-931432-931454

| | | | |
|------|---|----------|---------------|
| FL 6 | - Posteriore/Rear - Esterno/External Ø mm. 130 - Interno/Internal Ø mm. 78 - Spessore/Thickness mm. 90 | 85103257 | 931086 |
|------|---|----------|---------------|



| | | | |
|------|--|---------------------|---------------|
| FL 6 | - Posteriore/Rear - Esterno/External Ø mm. 140 - Interno/Internal Ø mm. 82 - Spessore/Thickness mm. 110 | 85103258 3096163 | 931420 |
|------|--|---------------------|---------------|



| | | | |
|--|--|-------------------|---------------|
| F10/12 FH12/16 FL6/7/10/12 FE F 7/10/12/16 FS7 N10 NH12 B 7/9/12 | - Cuscinetto esterno posteriore/ Rear external wheel bearing - Esterno/External Ø mm. 146,05 - Interno/Internal Ø mm. 82,55 - Spessore/Thickness mm. 41,28 | 184794 6889594 | 931417 |
|--|--|-------------------|---------------|



Connessione / Connected:  931419

EMMERRE

spare parts for trucks and trailers

VOLVO

CUSCINETTI
BEARINGS
ROULEMENTS
RADLAGERN
ПОДШИПНИКИ
RODAMIENTOS

| Emmerre | Adattabile a / Adaptable to | Dettagli / Detail | Applicazioni / Applications |
|---|-----------------------------|--|---|
| 931416  | 184795 | <ul style="list-style-type: none">- Cuscinetto interno posteriore/ <i>Rear internal wheel bearing</i>- Esterno/<i>External</i> Ø mm. 168,28- Interno/<i>Internal</i> Ø mm. 95,25- Spessore/<i>Thickness</i> mm. 41,28 | F 10/12 FH 12/16/FH16 II FL 6/7/10/12 FE F7/10/12/16 FS7 N10/NH12 B 7/9/12 |
| Connessione / Connected:  | | | 931419 |
| 931419  | OVKHB51010 | <ul style="list-style-type: none">- Revisione completa/<i>Complete revision</i>- Kit cuscinetti per assale/<i>Bearings kit for axle</i> | F 10/12 FH 12/16 FL 10/12 |
| Connessione / Connected:  931416-931417  | | | 101536-101532 |
| 931830  | 3099161 | <ul style="list-style-type: none">- Esterno/<i>External</i> Ø mm. 108- Interno/<i>internal</i> Ø mm. 60- Spessore/<i>Thickness</i> mm. 75- Anteriore/<i>Front</i> | FL6 |
| 931091  | 183735 184068 | <ul style="list-style-type: none">- Esterno/<i>External</i> Ø mm. 115- Interno/<i>internal</i> Ø mm. 75- Spessore/<i>Thickness</i> mm. 26 | Trucks |

CUSCINETTI
BEARINGS
ROULEMENTS
RADLAGERN
ПОДШИПНИКИ
RODAMIENTOS

EMMERRE
spare parts for trucks and trailers

VOLVO

| Applicazioni / Applications | Dettagli / Detail | Adattabile a / Adaptable to | Emmerre |
|-----------------------------|---|-----------------------------|---------------|
| B12 | - Esterno/External Ø mm. 160 - Interno/Internal Ø mm. 105 - Spessore/Thickness mm. 37,50 | 20582548 8171087 | 931087 |
| FL 6 | - Esterno/External Ø mm. 110 - Interno/Internal Ø mm. 50 - Spessore/Thickness mm. 42,25-43,50 | 11062 | 931396 |
| Trucks | - Esterno/External Ø mm. 120 - Interno/Internal Ø mm. 55 - Spessore/Thickness mm. 46 | 11095 183338 | 930994 |
| Trucks | - Esterno/External Ø mm. 180 - Interno/Internal Ø mm. 120 - Spessore/Thickness mm. 39,90 | 20853752 | 931083 |





Mozzi Ruota
Wheel Hubs

| Emmerre | Adattabile a / Adaptable to | Dettagli / Detail | Applicazioni / Applications |
|--|-----------------------------|---|-----------------------------|
| 931812  | 1699340 | - Esterno/External Ø mm. 130 - Interno/internal Ø mm. 60 - Spessore/Thickness mm. 48,50 | FL 10/12 FM 7/12 |
| 931813  | 3098132 | - Esterno/External Ø mm. 150 - Interno/internal Ø mm. 70 - Spessore/Thickness mm. 64 | B12 |
| 931108  | 1699339 | - Esterno/External Ø mm. 150 - Interno/internal Ø mm. 85 - Spessore/Thickness mm. 49 | FL 10/12 |
| 931380  | 184116 | - Esterno/External Ø mm. 170 - Interno/internal Ø mm. 110 - Spessore/Thickness mm. 47 | Trucks |

CUSCINETTI
BEARINGS
ROULEMENTS
RADLAGERN
ПОДШИПНИКИ
RODAMIENTOS

EMMERRE
spare parts for trucks and trailers

VOLVO

| Applicazioni / Applications | Dettagli / Detail | Adattabile a / Adaptable to | Emmerre |
|-----------------------------|---|-----------------------------|--|
| F 10/12 N10/B10 | - Esterno/External Ø mm. 170 - Interno/Internal Ø mm. 95 - Spessore/Thickness mm. 45,50 | 181086 181088 | 931099 |
| | | |  |
| FL 6 | - Esterno/External Ø mm. 110 - Interno/Internal Ø mm. 50 - Spessore/Thickness mm. 42,25-43,50 | 1699173 | 931162 |
| | | |  |
| | | | |
| | | | |

Mozzi Ruota
Wheel Hubs

Emmerre

Adattabile a / *Adaptable to*

Dettagli / *Detail*

Applicazioni / *Applications*

COLONNETTE RUOTA
WHEEL BOLTS
BOULON DE ROUE
RADBOLZEN
БОЛТЫ
TORNILLOS

EMMERRE
spare parts for trucks and trailers

BPW

| Applicazioni / Applications | Dettagli / Detail | Adattabile a / Adaptable to | Emmerre |
|---|--|-----------------------------|---------------|
| Axles | - Dado con rondella/Nut with washer - M 22 x 1,5 x 26 mm - Chiave / Key mm. 32 | 0526054100 0004010672 | 951103 |
|  | | | |
| Axles Ecoplus 8/9 Ton Series H/SH 10/12 Ton | - M 22 x 1,5 x 89 mm | 0329633141 | 951104 |
|  | | | |
| Axles Eco Maxx | - M 22 x 1,5 x 97 mm | 0329633121 0329633120 | 951105 |
|  | | | |
| Axles | - Dado/Nut - M 22 x 1,5 x 22 mm - Chiave / Key mm. 30 | 0326054030 | 933104 |
|  | | | |



| Emmerre | Adattabile a / Adaptable to | Dettagli / Detail | Applicazioni / Applications |
|--|--|---|-----------------------------------|
| 951076 | 1337020 0099720 | - Colonna ruota anteriore/ <i>Front wheel bolt</i> - M 22 x 1,5 x 75 mm | CF 75/85 XF 105/95 LF 45/55 |
|  | | | |
| Connessione / Connected:  931755-931753-931853-931855 | | | |
| 951077 | 1309191 620646 0099730 | - Colonna ruota anteriore e posteriore/ <i>Front and Rear wheel bolt</i> - M 22 x 1,5 x 85 mm | CF XF |
|  | | | |
| Connessione / Connected:  931751-931752-931851-931852 | | | |
| 951091 | 1373007 0099717 0620648 0620649 | - Colonna ruota posteriore/ <i>Rear wheel bolt</i> - M 22 x 1,5 x 104 mm | XF 105/95 CF 75/85 |
|  | | | |
| 933118 | 1356737 652575 1358990 | - Dado/Nut - M 22 x 1,5 x 31 mm - Chiave/Key 32 | |
|  | | | |

COLONNETTE RUOTA
WHEEL BOLTS
BOULON DE ROUE
RADBOLZEN
БОЛТЫ
TORNILLOS

EMMERRE
spare parts for trucks and trailers

DAF

| Applicazioni / Applications | Dettagli / Detail | Adattabile a / Adaptable to | Emmerre |
|------------------------------------|---|------------------------------|---|
| 85 CF 85 FA 95 FA 95 XF | - Colonna ruota posteriore/ <i>Rear wheel bolt</i> - M 22 x 1,5 x 94 mm | 1309190 890763 1356736 | 951092 |
| | | |  |
| F 1600/2100 2200 / 2300 2800 | - Rondella spaccata/ <i>Open washer</i> - Ø mm. 22 | 325235 | 933112 |
| | | |  |
| 95 XF 75 CF 85 CF | - Rondella conica/ <i>Conical washer</i> - Ø mm. 22 | 260261 | 933111 |
| | | |  |

| Emmerre | Adattabile a / Adaptable to | Dettagli / Detail | Applicazioni / Applications |
|---------------|--|--|---|
| 951063 | 42119082 503642393 46390477 7168330 7168346 | - Colonna ruota posteriore/ <i>Rear wheel bolt</i> - M18 x 1,5 x 58 mm | New Daily Turbodaily Zeta Turbozeta |
| | | | Connesione / Connected:  931008-931026 |
| 951060 | 42117463 2478620 7168257 46390478 503644306 503532592 | - Colonna ruota anteriore e posteriore/ <i>Front and Rear wheel bolt</i> - M18 x 1,5 x 65 mm | Daily Restyling Eurocargo Eurocargo Tector Eurocargo Tector Restyling New Daily Turbodaily |
| | | | Connesione / Connected:  931007-931017-931029-931046 |
| 933012 | 8527732 | - Colonna ruota posteriore/ <i>Rear wheel bolt</i> - M18 x 1,5 x 72 mm | Gammazeta |
| | | | Connesione / Connected:  931073 |
| 951066 | 42117465 7168333 | - Colonna ruota posteriore/ <i>Rear wheel bolt</i> - M18 x 1,5 x 75 mm | Eurocargo Eurocargo Tector |
| | | | Connesione / Connected:  931039 |

COLONNETTE RUOTA
WHEEL BOLTS
BOULON DE ROUE
RADBOLZEN
БОЛТЫ
TORNILLOS

EMMERRE
 spare parts for trucks and trailers

IVECO

| Applicazioni / Applications | Dettagli / Detail | Adattabile a / Adaptable to | Emmerre |
|-------------------------------|--|--|---------------|
| Eurocargo Eurocargo Tector | - Colonna ruota anteriore/ <i>Front wheel bolt</i> - M20 x 1,5 x 70 mm | 42117433 7168838 42101351 7186684 | 951059 |



| Connessione / Connected:  931033 | | | |
|---|--|--|--|
|---|--|--|--|

| | | | |
|---|--|---------------------------------|---------------|
| Eurocargo Eurocargo Tector Eurotech | - Colonna ruota anteriore e posteriore/ <i>Front and Rear wheel bolt</i> - M20 x 1,5 x 77 mm | 42064829 42117435 7170510 | 933115 |
|---|--|---------------------------------|---------------|



| Connessione / Connected:  931035-931048 | | | |
|--|--|--|--|
|--|--|--|--|

| | | | |
|-----------|--|----------------------|---------------|
| Eurocargo | - Colonna ruota posteriore/ <i>Rear wheel bolt</i> - M20 x 1,5 x 90 mm | 42064831 42117437 | 951070 |
|-----------|--|----------------------|---------------|



| Connessione / Connected:  931045 | | | |
|---|--|--|--|
|---|--|--|--|

| | | | |
|---|--|----------------------|---------------|
| Cursor Eurocargo Eurostar Eurotech Eurotrakker Tector Stralis | - Colonna ruota anteriore/ <i>Front wheel bolt</i> - M22 x 1,5 x 64 mm | 42064819 42127260 | 951065 |
|---|--|----------------------|---------------|



| Connessione / Connected:  931041 | | | |
|---|--|--|--|
|---|--|--|--|

I riferimenti indicati non sono originali ma perfettamente intercambiabili. I codici originali e le case costruttrici sono indicati a puro titolo informativo
 The details described are not original but perfectly interchangeable. The original references and manufacturer names are given for information purposes only.

| Emmerre | Adattabile a / Adaptable to | Dettagli / Detail | Applicazioni / Applications |
|--|---|--|---|
| 951068 | 42127262 42117448 | - Colonna ruota posteriore/ <i>Rear wheel bolt</i> - M22 x 1,5 x 77 mm | Eurocargo Euro rider Eurostar Cursor Eurotech Cursor Stralis |
|  | | | |
| Connessione / Connected:  | | | 931036-931043-931049 |
| 931058 | 7168585 7168580 2475870 | - Colonna ruota anteriore/ <i>Front wheel bolt</i> - M22 x 1,5 x 80 mm | Turbostar Turbotech |
|  | | | |
| Connessione / Connected:  | | | 931030 |
| 951069 | 42119444 42127229 2476077 | - Colonna ruota anteriore e posteriore/ <i>Front and Rear wheel bolt</i> - M22 x 1,5 x 86 mm | Eurotech Eurostar Eurotrakker Cursor Stralis |
|  | | | |
| Connessione / Connected:  | | | 931023-931070 |
| 951064 | 42117451 42117452 42064822 42064823 7168595 | - Colonna ruota anteriore e posteriore/ <i>Front and Rear wheel bolt</i> - M22 x 1,5 x 90 mm | Cursor Eurocargo Eurostar Eurotech Eurotrakker Stralis |
|  | | | |
| Connessione / Connected:  | | | 931037-931038 |

COLONNETTE RUOTA
WHEEL BOLTS
BOULON DE ROUE
RADBOLZEN
БОЛТЫ
TORNILLOS

EMMERRE
 spare parts for trucks and trailers

IVECO

| Applicazioni / Applications | Dettagli / Detail | Adattabile a / Adaptable to | Emmerre |
|---|---|---|---------------|
| Turbostar Turbotech | - Colonna ruota posteriore/ <i>Rear wheel bolt</i> - M22 x 1,5 x 101 mm | 7168465 42026222 42064824 42117453 42127220 | 933017 |
|  Connessione / Connected: 931031 | | | |
| 330 Eurotech Eurotech Cursor Eurotrakker Eurotrakker Cursor | - Colonna ruota posteriore/ <i>Rear wheel bolt</i> - M22 x 1,5 x 111 mm | 42117455 42064826 42127249 2475869 | 933016 |
|  Connessione / Connected: 931032-931040-931044 | | | |
| Eurostar Eurotech | - Colonna ruota posteriore/ <i>Rear wheel bolt</i> - M22 x 1,5 x 120 mm | 42117457 42117309 | 951067 |
|  Connessione / Connected: 931042 | | | |
| Daily City 2000 | - Dado con rondella/ <i>Nut with washer</i> - M 18 x 1,5 x 25 mm - Chiave/ <i>Key 27 mm</i> | 93805743 504356518 503476428 | 933122 |
|  Connessione / Connected: 931017-931007 | | | |



Mozzi Ruota
 Wheel Hubs

| Emmerre | Adattabile a / Adaptable to | Dettagli / Detail | Applicazioni / Applications |
|---|---|---|---|
| 933118 | -- | <ul style="list-style-type: none"> - Dado/Nut - M 22 x 1,5 mm - H 31 mm - Chiave/Key 32 mm | Iveco trucks |
| Connessione / Connected:  931030 | | | |
| 933119 | <ul style="list-style-type: none"> 4459603 41031725 42117503 42532190 | <ul style="list-style-type: none"> - Dado/Nut - M 22 x 1,5 mm - H 27 mm - Chiave/Key 32 mm | Iveco trucks |
| Connessione / Connected:  931030 | | | |
| 933126 | <ul style="list-style-type: none"> 41036369 41299920 | <ul style="list-style-type: none"> - Dado con prolunga per cerchi in lega/ <i>Nut with extension for alloy wheels</i> - M 22 x 1,5 mm - H 62 mm - Chiave/Key 32 mm | Eurocargo |
| 933127 | <ul style="list-style-type: none"> 41035863 41032670 41036368 | <ul style="list-style-type: none"> - Dado con prolunga per cerchi in lega/ <i>Nut with extension for alloy wheels</i> - M 22 x 1,5 mm - H 38,50 mm - Chiave/Key 32 mm | <ul style="list-style-type: none"> Eurostar Eurotech Eurotrakker |

COLONNETTE RUOTA
WHEEL BOLTS
BOULON DE ROUE
RADBOLZEN
БОЛТЫ
TORNILLOS

EMMERRE
spare parts for trucks and trailers

IVECO

| Applicazioni / Applications | Dettagli / Detail | Adattabile a / Adaptable to | Emmerre |
|--|---|-----------------------------|---------------|
| Eurocargo Eurotech Eurostar Stralis Trakker | - Colonna disco freno/ <i>Brake disc bolt</i> - M16 x 2 x 88 mm - Chiave/Key 21 mm | 16683434 | 951120 |
|  | | | |
| Connessione / Connected:  960033-960034 | | | |
| Eurocargo | - Dado con rondella/ <i>Nut with washer</i> - M 20 x 1,5 x 26 mm - Chiave/Key 30 mm | 2476979 504071276 | 933121 |
|  | | | |
| Turbostar Turbotech | - Rondella/ <i>Washer</i> - Ø 22 mm - Conica/ <i>conical</i> | 3420371 | 933111 |
|  | | | |
| Turbostar Turbotech | - Rondella spaccata/ <i>Open washer</i> - Ø 22 mm | 504023611 1121811 | 933112 |
|  | | | |

Emmerre

Adattabile a / *Adaptable to*

Dettagli / *Detail*

Applicazioni / *Applications*

933104

41800483

- Dado/*Nut*
- M 22 x 1,5 x 22 mm
- Chiave/*Key* 30 mm

Turbostar 330



COLONNETTE RUOTA
WHEEL BOLTS
BOULON DE ROUE
RADBOLZEN
БОЛТЫ
TORNILLOS

EMMERRE
 spare parts for trucks and trailers

MAN

| Applicazioni / Applications | Dettagli / Detail | Adattabile a / Adaptable to | Emmerre |
|-----------------------------|--|---|---|
| F90/M90 | - Dado/Nut - M 22 x 1,5 x 22 mm - Chiave/Key 30 mm | 06112220218 | 933104 |
| | | |  |
| F 2000 F 90 | - Colonneta ruota posteriore/ <i>Rear wheel bolt</i> - Ø 22 x 1,5 x 110 mm | 81455010067 81455010082 81455010141 | 951082 |
| | | |  |
| Trucks | - Colonneta ruota anteriore/ <i>Front wheel bolt</i> - Ø 22 x 1,5 x 80,50 mm | 81455010164 81455010133 | 951098 |
| | | |  |
| F 2000 F / M 90 | - Rondella spaccata/ <i>Open washer</i> - Ø mm. 22 | 81455020001 | 933112 |
| | | |  |

Mozi Ruota
Wheel Hubs

| Emmerre | Adattabile a / Adaptable to | Dettagli / Detail | Applicazioni / Applications |
|--|-----------------------------|--|-----------------------------|
| 951130   | 06019022812 | - Colonna disco freno/ <i>Brake disc bolt</i> - M16 x 1,5 x 55,5 mm - TORX | TGA TGS TGX |
| 951131   | 81904900776 | - Colonna disco freno/ <i>Brake disc bolt</i> - M12 x 1,5 x 112 mm - TORX | TGA TGS TGX |
| | | | |
| | | | |

COLONNETTE RUOTA
WHEEL BOLTS
BOULON DE ROUE
RADBOLZEN
БОЛТЫ
TORNILLOS

EMMERRE
spare parts for trucks and trailers

MERCEDES



| Applicazioni / Applications | Dettagli / Detail | Adattabile a / Adaptable to | Emmerre |
|--|--|------------------------------|---|
| Actros Actros MP2/MP3/MP4 Atego Axor/Axor II Citaro Econic | - Colonna disco freno/ <i>Brake disc bolt</i> - M14 x 1,5 x 60 mm - Chiave/Key 21 mm | 914126014012 | 951140 |
| | | |  |
| Actros Actros MP2/MP3/MP4 Arocs Atego/Atego II Axor/Axor II Citaro/Tourismo Econic/Travego | - Colonna disco freno/ <i>Brake disc bolt</i> - M14 x 1,5 x 75 mm - TORX | 9429900004 | 951141 |
| | | |  |
| Actros Actros MP2 Atego Axor II | - Colonna ruota anteriore/ <i>Front wheel bolt</i> - M 22 x 1,5 x 80,50 mm | 3894010071 0004012471 | 951098 |
| | | |  |
| Actros Actros MP2 Axor 2 | - Rondella spaccata/ <i>Open washer</i> - Ø mm. 22 | 074361022351 074361022352 | 933112 |
| | | |  |

| Emmerre | Adattabile a / Adaptable to | Dettagli / Detail | Applicazioni / Applications |
|---|-----------------------------|--|--|
| 933111 | 3174020175 | - Rondella conica / <i>Conical washer</i> - Ø 22 mm | Actros Actros MP2 Actros MP3 Axor Axor 2 |
|  | | | |
| 931827.1 | 910105014010 | - Colonna disco freno / <i>Brake disc bolt</i> - M14 x 1,5 x 45 mm - Chiave / <i>Key</i> 21 mm | Axle TE4/TE5 VT |
|   | | | |
| Connessione / Connected:  | | | 931827-931832 |
| 933104 | 074361022205 | - Dado / <i>Nut</i> - M 22 x 1,5 x 22 mm - Chiave / <i>Key</i> 30 mm | Axor Axor 2 Actros MP2 Actros |
|  | | | |
| 951082 | 3814010771 3464010071 | - Colonna Ruote posteriori / <i>Rear wheels bolt</i> - M 22 x 1,5 x 110 mm | Actros Actros MP2 - MP3 Atego Axor - Axor 2 NG/SK/MK/T2L |
|  | | | |

COLONNETTE RUOTA
WHEEL BOLTS
BOULON DE ROUE
RADBOLZEN
БОЛТЫ
TORNILLOS

EMMERRE
spare parts for trucks and trailers

MERCEDES

| Applicazioni / Applications | Dettagli / Detail | Adattabile a / Adaptable to | Emmerre |
|------------------------------------|--|--|---------------|
| Actros Atego assali Mercedes | - Colonna Ruote posteriori/ <i>Rear wheels bolt</i> - M 22 x 1,5 x 68 mm | 9424010271 0004012371 | 951085 |
| | |  | |
| Actros Atego | - Colonna Ruote posteriori/ <i>Rear wheels bolt</i> - M 22 x 1,5 x 90 mm | 9424010371 0004014171 | 951086 |
| | |  | |
| | | | |
| | | | |

Mozi Ruota
Wheel Hubs

EMMERRE

spare parts for trucks and trailers

RENAULT

COLONNETTE RUOTA
WHEEL BOLTS
BOULON DE ROUE
RADBOLZEN
БОЛТЫ
TORNILLOS

| Emmerre | Adattabile a / Adaptable to | Dettagli / Detail | Applicazioni / Applications |
|--|--|---|---|
| 933128  | 5010262935 5010457733 5010097347 | - Dado con rondella/ <i>Nut with washer</i> - M 22 x 1,5 x 31 mm - Chiave/ <i>Key</i> 33 mm | Magnum Premium Kerax Midlum Midliner Manager Maxter |
| 951071  | 7420515517 | - Colonna Ruote posteriori/ <i>Rear wheels bolt</i> - M 22 x 1,5 x 97 mm | Magnum Premium 2 Kerax Midlum |
| Connessione / Connected:  931426-931438 | | | |
| 951074  | 7420515514 | - Colonna Ruote anteriori/ <i>Front wheels bolt</i> - M 22 x 1,5 x 79 mm | Magnum Premium 2 |
| Connessione / Connected:  931427-931433-931440-931443 | | | |
| 951079  | 0000190220 5010439317 5010439406 | - Colonna Ruote posteriori/ <i>Rear wheels bolt</i> - M 22 x 1,5 x 97 mm | Manager Maxter Major |

COLONNETTE RUOTA
WHEEL BOLTS
BOULON DE ROUE
RADBOLZEN
БОЛТЫ
TORNILLOS

EMMERRE
spare parts for trucks and trailers

RENAULT

| Applicazioni / Applications | Dettagli / Detail | Adattabile a / Adaptable to | Emmerre |
|--|---|-----------------------------|---|
| Magnum Manager Maxter Major | - Colonna Ruote anteriori/ <i>Front wheels bolt</i> - M 22 x 1,5 x 79 mm | 5010319141 | 951080 |
| | | |  |
| Kerax | - Colonna Ruote posteriori/ <i>Rear wheels bolt</i> - M 22 x 1,5 x 87 mm | 7420515515 | 951032 |
| | | |  |
| Kerax Magnum | - Colonna Ruote posteriori/ <i>Rear wheels bolt</i> - M 22 x 1,5 x 114 mm | 7420524942 7421147687 | 951037 |
| | | |  |
| Kerax Magnum Major Manager Maxter Midlum Premium 2 | - Dado con rondella/ <i>Nut with washer</i> - M 22 x 1,5 x 30 mm - Chiave/Key 33 mm | 5000788677 7421303956 | 951073 |
| | | |  |

| Emmerre | Adattabile a / Adaptable to | Dettagli / Detail | Applicazioni / Applications |
|--|-----------------------------|--|-----------------------------|
| 933140   | 21226340 | - Colonneta ruote/ <i>Wheels bolt</i> Ø 22 x 1,5 x 95 mm | Axle LM/LMC TE/TMC TA |
| 933119   | 21203099 | - Dado/ <i>Nut</i> - M 22 x 1,5 x 27 mm - Chiave/ <i>Key</i> 32 mm | Axle LM/LMC TE/TMC TA |

COLONNETTE RUOTA
WHEEL BOLTS
BOULON DE ROUE
RADBOLZEN
БОЛТЫ
TORNILLOS

EMMERRE
spare parts for trucks and trailers

SAF

| Applicazioni / Applications | Dettagli / Detail | Adattabile a / Adaptable to | Emmerre |
|-----------------------------|--|-----------------------------|---------------|
| Axle | - Colonna disco freno/Brake disc bolt M12 x 1,5 x 75 mm | 4375100512 | 951100 |



| Connessione / Connected:  960396-960395 | | | |
|--|--|------------------------|---------------|
| Axle | - Dado/Nut - M 22 x 1,5 x 27 mm - Chiave/Key 32 mm | 424301200 424301201 | 933119 |



| | | | |
|--------------|--|------------|---------------|
| Axle SKRB | - Kit viti disco freno/Brake disc bolts kit - M12 x 1,5 x 75 mm - TORX | 3434366200 | 951150 |
|--------------|--|------------|---------------|



| | | | |
|---|--|------------|---------------|
| Axle ZIL 9/11 B9/S19 SI11/Z19/ZI11/BL9 | - Kit viti disco freno/Brake disc bolts kit - M14 x 1,5 x 64 mm - TORX | 3434366300 | 951151 |
|---|--|------------|---------------|



| Emmerre | Adattabile a / <i>Adaptable to</i> | Dettagli / <i>Detail</i> | Applicazioni / <i>Applications</i> |
|--|--|---|------------------------------------|
| 931600.5 | 4343280110 | - Colonna tipo Torx/ <i>Torx Bolt</i> - M18 x 1,5 x 65 mm | Axles |
| Connessione / <i>Connected:</i>  931600 | | | |
| 951101 | 1303107512 1303107511 1303107411 | - Colonna Ruote posteriori/ <i>Rear wheels bolt</i> - M 22 x 1,5 x 93 mm | Axles |
| 951102 | 1303111811 | - Colonna Ruote posteriori/ <i>Rear wheels bolt</i> - M 22 x 1,5 x 68 mm | Axles |
| 933112 | 4141100300 | - Rondella spaccata/ <i>Open washer</i> - Ø mm. 22 | Axles |



COLONNETTE RUOTA
WHEEL BOLTS
BOULON DE ROUE
RADBOLZEN
БОЛТЫ
TORNILLOS

EMMERRE
 spare parts for trucks and trailers

SCANIA

| Applicazioni / Applications | Dettagli / Detail | Adattabile a / Adaptable to | Emmerre |
|---|--|--|---|
| 141/142/143 Serie 3/4 | - Dado ruote/Wheel nut - 7/8" - 11 BSF x 27,7 mm - Chiave/Key 33 | 1749034 1365510 318690 243956 | 933129 |
| | | |  |
| 141/142/143 Serie 3/4 | - Colonna ruote posteriori/ Rear wheel bolt - 7/8" - 11 BSF - 86 mm | 1368693 295953 | 951088 |
| | | |  |
| P.G.R.T. Serie 4 Serie 3 Serie K | - Colonna ruote anteriori/ Front wheel bolt - 7/8" - 11 BSF - 68 mm | 1368690 | 951097 |
| | | |  |
| P.G.R.T. Serie 4 | - Colonna ruote posteriori/ Rear wheel bolt - 7/8" - 11 BSF - 85 mm | 1528712 | 951089 |
| | | |  |

Mozzi Ruota
Wheel Hubs

| Emmerre | Adattabile a / Adaptable to | Dettagli / Detail | Applicazioni / Applications |
|---------------|-----------------------------|---|-----------------------------|
| 951090 | 1868665 | - Colonna ruote anteriori/ <i>Front wheel bolt</i> - 7/8" - 11 BSF - 72 mm | P.G.R.T. Series 4 |



SCHMITZ

| Emmerre | Adattabile a / Adaptable to | Dettagli / Detail | Applicazioni / Applications |
|-----------------|-----------------------------|--|-----------------------------|
| 931600.5 | -- | - Colonna tipo Torx/ <i>Torx Bolt</i> - M18 X 1,5 X 65 | Axles |



Connessione / Connected:  931600

COLONNETTE RUOTA
WHEEL BOLTS
BOULON DE ROUE
RADBOLZEN
БОЛТЫ
TORNILLOS

EMMERRE
spare parts for trucks and trailers

VOLVO

| Applicazioni / Applications | Dettagli / Detail | Adattabile a / Adaptable to | Emmerre |
|-----------------------------|--|-----------------------------|---------------|
| FH - FM | - Colonna ruote posteriori/Rear wheel bolt - M 22 x 1,5 x 97 mm | 20515517 | 951071 |



| Connessione / Connected:  931426-931438 | | | |
|--|--|----------|---------------|
| FH - FM | - Colonna ruote anteriori/Front wheel bolt - M 22 x 1,5 x 79 mm | 20515514 | 951074 |



| Connessione / Connected:  931427-931433-931440-931443 | | | |
|--|---|---------|---------------|
| FH - FM | - Colonna ruote anteriori/Front wheel bolt - 7/8" - 14 UNF x 77 mm | 3112593 | 951075 |



| Connessione / Connected:  931429-931432-931441-931442 | | | |
|--|--|---------|---------------|
| FH - FM | - Colonna ruote posteriori/Rear wheel bolt - 7/8" - 14 UNF x 93,50 mm | 3963997 | 951078 |



| Connessione / Connected:  931431-931439 | | | |
|--|--|----------|---------------|
| FH - FM | - Colonna ruote anteriori/Front wheel bolt - M 22 x 1,5 x 79 mm | 20515514 | 951074 |

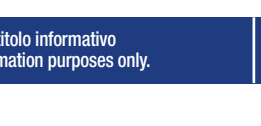

I riferimenti indicati non sono originali ma perfettamente intercambiabili. I codici originali e le case costruttrici sono indicati a puro titolo informativo
The details described are not original but perfectly interchangeable. The original references and manufacturer names are given for information purposes only.

| Emmerre | Adattabile a / Adaptable to | Dettagli / Detail | Applicazioni / Applications |
|---|-------------------------------|--|--|
| 951026 | 1573082 | - Colonna ruote posteriori/Rear wheel bolt - 7/8" x 14 UNF x 102 mm | FH 12/16 FM 7/9/10/12 FL 6/7/10/12 |
|  | | | |
| 951027 | 1589009 1573083 1589010 | - Colonna ruote posteriori/Rear wheel bolt - 7/8" x 14 UNF x 111 mm | FH 12/16 FM 9/12 |
|  | | | |
| 951032 | 20515515 | - Colonna ruote posteriori/Rear wheel bolt - M 22 - 1,5 x 87 mm | FL 6 FH 16/12 FM 9/12 FMX/FMXII |
|  | | | |
| 951037 | 20524942 21147687 | - Colonna ruote posteriori/Rear wheel bolt - M 22 - 1,5 x 113 mm | FH 12/16 FMX/FMXII |
|  | | | |

COLONNETTE RUOTA
WHEEL BOLTS
BOULON DE ROUE
RADBOLZEN
БОЛТЫ
TORNILLOS

EMMERRE
spare parts for trucks and trailers

VOLVO

| Applicazioni / Applications | Dettagli / Detail | Adattabile a / Adaptable to | Emmerre |
|--|---|----------------------------------|---------------|
| F 90 M 90 | - Dado con rondella/Nut with washer - M 20 x 1,5 x 26 mm - Chiave/Key 30 mm | 947971 | 933121 |
| F 10/12 FH 16/12/16 II FL 10/6/7/12 FM 9/10/12 NH12 | - Dado con rondella/Nut with washer - 7/8" - 14 UNF - Chiave/Key 33 mm | 1083894 943491 | 951072 |
| FE / FL / FL II FH 12/16 FM / FM12/9 FMX / FMX II NH12 | - Dado con rondella/Nut with washer - M22 x 1,5 X 30 mm - Chiave/Key 33 mm | 20551045 21303956 21402076 | 951073 |



ANELLI PARAOLIO
OIL SEALS
PARE-HUILES
WELLENDICHTRINGE
САЛЬНИКИ
RETEEN

EMMERRE
spare parts for trucks and trailers

BPW

| Applicazioni / Applications | Dettagli / Detail | Adattabile a / Adaptable to | Emmerre |
|--|---|---|---------------|
| Axle Eco 8-9 ton 20" | <ul style="list-style-type: none"> - NBR - Lato interno/<i>Internal side</i> - Interno/<i>Internal</i> Ø mm 115 - Esterno/<i>External</i> Ø mm 136,7 - Altezza/<i>Height</i> mm 8/10,5 - Per mozzo ruota/<i>For wheel hub</i> | 0256645700 0256645564 001016766B0 | 101539 |
| Connessione / Connected:  931370-931371-931393-931402-931404-931459-931461-931465-931482-931484 | | | |
| Axle Eco 10-12 ton 20" | <ul style="list-style-type: none"> - NBR - Lato interno/<i>Internal side</i> - Interno/<i>Internal</i> Ø mm 135 - Esterno/<i>External</i> Ø mm 156,70 - Altezza/<i>Height</i> mm 8/12 - Per mozzo ruota/<i>For wheel hub</i> | 0256645800 0256645664 001026187B0 | 101540 |
| Connessione / Connected:  931376-931391-931405-931466 | | | |
| Axle Eco Plus H 8-9 ton | <ul style="list-style-type: none"> - NBR - Lato interno/<i>Internal side</i> - Interno/<i>Internal</i> Ø mm 117,50 - Esterno/<i>External</i> Ø mm 157,50 - Altezza/<i>Height</i> mm 17,50 - Per mozzo ruota/<i>For wheel hub</i> | 0256646800 | 101543 |
| Axle Eco 8-9 ton | <ul style="list-style-type: none"> - BA + FE - Lato interno/<i>Internal side</i> - Interno/<i>Internal</i> Ø mm 117,50 - Esterno/<i>External</i> Ø mm 158 - Altezza/<i>Height</i> mm 17,80 - Per mozzo ruota/<i>For wheel hub</i> | 0256647400 | 101544 |
| Connessione / Connected:  931403-931437-931398-931408-931374-931381-931392-931458-931460-931463 | | | |

| Emmerre | Adattabile a / <i>Adaptable to</i> | Dettagli / <i>Detail</i> | Applicazioni / <i>Applications</i> |
|--|------------------------------------|---|------------------------------------|
| <p>101525</p>  | <p>01001200</p> | <p>- NBR - Interno/<i>Internal</i> Ø mm 110 - Esterno/<i>External</i> Ø mm 160 - Altezza/<i>Height</i> mm 15 - Per mozzo ruota/<i>For wheel hub</i></p> | <p>All trailers</p> |
| | | | |
| | | | |
| | | | |

ANELLI PARAOLIO
OIL SEALS
PARE-HUILES
WELLENDICHTRINGE
САЛЬНИКИ
RETEN

EMMERRE
spare parts for trucks and trailers

DAF

| Applicazioni / Applications | Dettagli / Detail | Adattabile a / Adaptable to | Emmerre |
|-------------------------------|--|-----------------------------|---------------|
| LF 45 2500 2800 3600 | - NBR - Anteriore/Front - Interno/Internal Ø mm 100 - Esterno/External Ø mm 135 - Altezza/Height mm 13/12 - Per mozzo ruota/For wheel hub | 647330 012015029B0 | 101523 |
| | | | |
| | | | |
| | | | |



Mozzi Ruota
Wheel Hubs

EMMERRE

spare parts for trucks and trailers

IVECO

ANELLI PARAOLIO
OIL SEALS
PARE-HUILES
WELLENDICHTRINGE
САЛЬНИКИ
RETEN

| Emmerre | Adattabile a / Adaptable to | Dettagli / Detail | Applicazioni / Applications |
|---|---|---|--|
| 101400 | 93804576 40003260 012011409B0 | - NBR - Anteriore/ <i>Front</i> - Interno/ <i>Internal</i> Ø mm 55 - Esterno/ <i>External</i> Ø mm 80 - Altezza/ <i>Height</i> mm 10 - Per mozzo ruota/ <i>For wheel hub</i> | New Daily '96 Daily Restyling Turbodaily '96 |
|  | | | |
| 101401 | 40100483 40100480 40002630 012014289B0 | - Polyacril ACM - Posteriore/ <i>Rear</i> - Interno/ <i>Internal</i> Ø mm 70 - Esterno/ <i>External</i> Ø mm 90 - Altezza/ <i>Height</i> mm 12 - Per mozzo ruota/ <i>For wheel hub</i> | New Daily '96 Turbodaily '96 Eurocargo |
|  | | | |
| Connessione / Connected  963084-963089 | | | |
| 101402 | 40102273 40102270 012015793B0 | - Viton FPM - Posteriore/ <i>Rear</i> - Interno/ <i>Internal</i> Ø mm 70 - Esterno/ <i>External</i> Ø mm 90 - Altezza/ <i>Height</i> mm 13,5-14,5 - Per mozzo ruota/ <i>For wheel hub</i> | New Daily '96 Turbodaily '96 Eurocargo |
|  | | | |
| 101518 | 40102283 40102280 012015792B0 | - Viton FPM - Posteriore/ <i>Rear</i> - Lato interno/ <i>Internal side</i> - Interno/ <i>Internal</i> Ø mm 70 - Esterno/ <i>External</i> Ø mm 100 - Altezza/ <i>Height</i> mm 13,5/15 - Per mozzo ruota/ <i>For wheel hub</i> | New Daily Turbodaily |
|  | | | |

ANELLI PARAOLIO
OIL SEALS
PARE-HUILES
WELLENDICHTRINGE
САЛЬНИКИ
RETEN

EMMERRE
spare parts for trucks and trailers

IVECO

| Applicazioni / Applications | Dettagli / Detail | Adattabile a / Adaptable to | Emmerre |
|---|---|-------------------------------------|---|
| Turbodaily Eurocargo Eurorider Eurotech Eurotrakker | - Polyacryl ACM - Posteriore/Rear - Lato interno/Internal side - Interno/Internal Ø mm 100 - Esterno/External Ø mm 130 - Altezza/Height mm 12 - Per mozzo ruota/For wheel hub | 40100463 40100460 012014422B0 | 101528 |
| | | |  |
| Zeta Turbozeta Turbotech | - NBR - Anteriore/Front - Interno/Internal Ø mm 75 - Esterno/External Ø mm 100 - Altezza/Height mm 13 - Per mozzo ruota/For wheel hub | 40001883 40001880 012011411B0 | 101403 |
| | | |  |
| 115 135.14/17 145.17 Zeta Turbozeta | - NBR - Anteriore e posteriore/Front and rear - Interno/Internal Ø mm 90 - Esterno/External Ø mm 110 - Altezza/Height mm 13 - Per mozzo ruota/For wheel hub | 40001903 40001900 012011412B0 | 101404 |
| | | |  |
| 115.14 115.17 135.14 135.17 Zeta | - Polyacryl ACM - Posteriore/Rear - Interno/Internal Ø mm 100 - Esterno/External Ø mm 130 - Altezza/Height mm 14 - Per mozzo ruota/For wheel hub | 40100113 40100110 012001580B0 | 101501 |
| | | |  |

Mozzi Ruota
Wheel Hubs

| Emmerre | Adattabile a / <i>Adaptable to</i> | Dettagli / <i>Detail</i> | Applicazioni / <i>Applications</i> |
|---|---|---|---|
| 101405 | 40001030 40001031 012011364B0 | - NBR - Anteriore/ <i>Front</i> - Interno/ <i>Internal</i> Ø mm 110 - Esterno/ <i>External</i> Ø mm 130 - Altezza/ <i>Height</i> mm 13 - Per mozzo ruota/ <i>For wheel hub</i> | 100 110NC 645 650 662N1 662N2 662N3 |
|  | | | |
| 101513 | 40001060 40001061 012011347B0 | - NBR - Posteriore/ <i>Rear</i> - Lato esterno/ <i>External side</i> - Interno/ <i>Internal</i> Ø mm 118 - Esterno/ <i>External</i> Ø mm 136 - Altezza/ <i>Height</i> mm 13 - Per mozzo ruota/ <i>For wheel hub</i> | 79 80 90 100.13 110NC 130NC 110.14 |
|  | | | |
| 101514 | 40001050 40001051 012011372B0 | - NBR - Posteriore/ <i>Rear</i> - Lato interno/ <i>Internal side</i> - Interno/ <i>Internal</i> Ø mm 135 - Esterno/ <i>External</i> Ø mm 162 - Altezza/ <i>Height</i> mm 13 - Per mozzo ruota/ <i>For wheel hub</i> | 100 110 130NC |
|  | | | |
| 101500 | 40100653 40100650 40100050 012014598B0 | - Polyacryl ACM - Posteriore/ <i>Rear</i> - Lato interno/ <i>Internal side</i> - Interno/ <i>Internal</i> Ø mm 134 - Esterno/ <i>External</i> Ø mm 152 - Altezza/ <i>Height</i> mm 14 - Per mozzo ruota/ <i>For wheel hub</i> | 115.14 115.17 135.14 135.17 109.14 |
|  | | | |

ANELLI PARAOLIO
OIL SEALS
PARE-HUILES
WELLENDICHTRINGE
САЛЬНИКИ
RETEN

EMMERRE
spare parts for trucks and trailers

IVECO

| Applicazioni / Applications | Dettagli / Detail | Adattabile a / Adaptable to | Emmerre |
|-----------------------------|---|--|---------------|
| 145.17 175.24 | <ul style="list-style-type: none"> - Polyacril ACM - Posteriore/Rear - Lato esterno/External side - Interno/Internal Ø mm 140 - Esterno/External Ø mm 160 - Altezza/Height mm 14 - Per mozzo ruota/For wheel hub | 40100103 40100100 40100200 012011593B0 | 101502 |
| | |  | |
| Eurocargo 60/65/75/80 | <ul style="list-style-type: none"> - Viton FPM - Anteriore/Front - Interno/Internal Ø mm 65 - Esterno/External Ø mm 90 - Altezza/Height mm 13/14 - Per mozzo ruota/For wheel hub | 40102293 012015928B0 | 101495 |
| | |  | |
| Eurocargo | <ul style="list-style-type: none"> - Viton FPM - Anteriore/Front - Interno/Internal Ø mm 80 - Esterno/External Ø mm 110/115 - Altezza/Height mm 9/13 - Per mozzo ruota/For wheel hub | 40102303 40102301 40100473 012033893B0 | 101521 |
| | |  | |
| Eurocargo | <ul style="list-style-type: none"> - Viton FPM - Posteriore/Rear - Interno/Internal Ø mm 114,10 - Esterno/External Ø mm 152/159,30 - Altezza/Height mm 14 - Per mozzo ruota/For wheel hub | 40102321 40102320 012017353B0 | 101551 |
| | |  | |

Mozzi Ruota
Wheel Hubs

Connessione / Connected:  930992-931045

I riferimenti indicati non sono originali ma perfettamente intercambiabili. I codici originali e le case costruttrici sono indicati a puro titolo informativo
The details described are not original but perfectly interchangeable. The original references and manufacturer names are given for information purposes only.

| Emmerre | Adattabile a / Adaptable to | Dettagli / Detail | Applicazioni / Applications |
|--|-------------------------------------|---|--|
| 101406 | 40001933 40001930 012011419B0 | - NBR - Anteriore/ <i>Front</i> - Interno/ <i>Internal</i> Ø mm 125 - Esterno/ <i>External</i> Ø mm 150 - Altezza/ <i>Height</i> mm 13 - Per mozzo ruota/ <i>For wheel hub</i> | 175.24 260.36 260.48 Turbostar Turbotech |
| Connessione / Connected:  930985-931030 | | | |
| 101509 | 40000950 012011278B0 | - Polyacryl ACM - Posteriore/ <i>Rear</i> - Lato esterno/ <i>External side</i> - Interno/ <i>Internal</i> Ø mm 150 - Esterno/ <i>External</i> Ø mm 168 - Altezza/ <i>Height</i> mm 13 - Per mozzo ruota/ <i>For wheel hub</i> | 170.33 170.35 619N1 697-300-180NC 684NP 682N4 |
| 101510 | 40000690 7165392 012011379B0 | - NBR - Posteriore/ <i>Rear</i> - Lato interno/ <i>Internal side</i> - Interno/ <i>Internal</i> Ø mm 180 - Esterno/ <i>External</i> Ø mm 200 - Altezza/ <i>Height</i> mm 15 - Per mozzo ruota/ <i>For wheel hub</i> | 170.33 170.35 619N1 697-300-180NC |
| 931317 | 2475977 | - Cuoio/ <i>Leather</i> - Interno/ <i>Internal</i> Ø mm 117,50 - Esterno/ <i>External</i> Ø mm 152,40 - Altezza/ <i>Height</i> mm 21 - Per mozzo ruota/ <i>For wheel hub</i> - Originale Stemco/Original Stemco | 190-330.30H 190-330.26H 330.30 AN 190 PAC |

ANELLI PARAOLIO
OIL SEALS
PARE-HUILES
WELLENDICHTRINGE
САЛЬНИКИ
RETEN

EMMERRE
spare parts for trucks and trailers

IVECO

| Applicazioni / Applications | Dettagli / Detail | Adattabile a / Adaptable to | Emmerre |
|--|--|--|---------------|
| 175.24 Turbostar Turbotech Eurocargo Eurotech Eurotrakker Cursor Trakker | - Viton FPM - Posteriore/Rear - Lato interno-esterno/Internal-external side - Interno/Internal Ø mm 180 - Esterno/External Ø mm 200 - Altezza/Height mm 17 - Per mozzo ruota/For wheel hub | 40101733 40101730 012015265B0 | 101508 |
| | |  | |
| 175.24 Turbostar Turbotech Eurocargo Eurotech Eurotrakker Eurotrakker Cursor | - NBR - Posteriore/Rear - Lato esterno/External side - Interno/Internal Ø mm 180 - Esterno/External Ø mm 200 - Altezza/Height mm 12 - Per mozzo ruota/For wheel hub | 40100443 40003720 40100440 40100439 012011378B0 | 101506 |
| | |  | |
| 175.24 Turbostar Turbotech Eurocargo Eurotech Eurotrakker Cursor | - Viton FPM - Posteriore/Rear - Lato interno/Internal side - Interno/Internal Ø mm 180 - Esterno/External Ø mm 200 - Altezza/Height mm 12 - Per mozzo ruota/For wheel hub | 40100673 40003730 40100670 40100671 012014190B0 | 101507 |
| | |  | |
| Connezzione / Connected:  931031-931040 | | | |
| Eurocargo Tector Eurotech Eurotrakker Trakker Cursor | - Viton FPM - Anteriore/Front - Interno/Internal Ø mm 60 - Esterno/External Ø mm 77 - Altezza/Height mm 12/14 - Per mozzo ruota/For wheel hub | 40102093 40101603 012014618B0 | 101565 |
| | |  | |

EMMERRE

spare parts for trucks and trailers

IVECO

ANELLI PARAOLIO
OIL SEALS
PARE-HUILES
WELLENDICHTRINGE
САЛЬНИКИ
RETEN

| Emmerre | Adattabile a / Adaptable to | Dettagli / Detail | Applicazioni / Applications |
|--|---|--|--|
| 101566  | 40102503 40102113 40101610 40102110 012017147B0 | - Viton FPM - Anteriore/Front - Interno/Internal Ø mm 66 - Esterno/External Ø mm 92 - Altezza/Height mm 19 - Per mozzo ruota/For wheel hub | Eurocargo Tector Eurotech Eurotrakker Trakker Cursor |
| 101519  | 42127526 012012049B0 | - NBR Blu - Posteriore/Rear - Lato esterno/External side - Interno/Internal Ø mm 180 - Esterno/External Ø mm 200 - Altezza/Height mm 12 | Turbostar Turbotech Eurocargo Eurotech Eurostar Eurotrakker Cursor |
| Connessione / Connected:  930983-930984-930990-931031-931040-931044 | | | |
| 101512  | 42127773 40102821 01201960B0 | - Posteriore/Rear - Interno/Internal Ø mm 180 - Esterno/External Ø mm 200 - Altezza/Height mm 13,5 - Per mozzo ruota/For wheel hub | Turbostar Trakker |
| 101559  | 7185250 40102143 40102140 012015509B0 | - Viton FPM - Anteriore/Front - Interno/Internal Ø mm 95 - Esterno/External Ø mm 130 - Altezza/Height mm 16 - Per mozzo ruota/For wheel hub | Eurotech Eurostar Eurotrakker Cursor Stralis |
| Connessione / Connected:  930979-930993-931064-931035-931144-931137 | | | |

ANELLI PARAOLIO
OIL SEALS
PARE-HUILES
WELLENDICHTRINGE
САЛЬНИКИ
RETEN

EMMERRE
spare parts for trucks and trailers

IVECO

| Applicazioni / Applications | Dettagli / Detail | Adattabile a / Adaptable to | Emmerre |
|---|---|---|---|
| Eurocargo Eurotech Cursor Eurostar Eurorider Stralis | - Viton FPM - Posteriore/Rear - Interno/Internal Ø mm 121 - Esterno/External Ø mm 170 - Altezza/Height mm 15,5/17 - Per mozzo ruota/For wheel hub | 40102333 40102330 012015880B0 | 101550 |
| | | |  |
| Eurotech Eurostar Eurotrakker | - Viton FPM - Posteriore/Rear - Lato esterno/External side - Interno/Internal Ø mm 179 - Esterno/External Ø mm 200 - Altezza/Height mm 15,7 - Per mozzo ruota/For wheel hub | 40102941 40102943 012017354B0 | 101511 |
| | | |  |
| Connessione / Connected:  931042 | | | |
| Eurocargo Tector Eurotech Eurotrakker Trakker Cursor | - Viton FPM - Anteriore/Front - Interno/Internal Ø mm 128 - Esterno/External Ø mm 144/152,30 - Altezza/Height mm 11/26 - Per mozzo ruota/For wheel hub | 40102103 40101420 40101123 40102100 012015506B0 | 101567 |
| | | |  |
| Connessione / Connected:  931037 | | | |
| Daily City 2000 | - Viton FPM - Interno/Internal Ø mm 42 - Esterno/External Ø mm 76 - Altezza/Height mm 10 - Per cambio/For gear box | 8870829 42534932 8869681 012030146B0 | 101612 |
| | | |  |

| Emmerre | Adattabile a / Adaptable to | Dettagli / Detail | Applicazioni / Applications |
|---|---|---|--|
| 101517 | 7185870 40102263 012019512B0 | - Viton FPM - Interno/ <i>Internal</i> Ø mm 60 - Esterno/ <i>External</i> Ø mm 90 - Altezza/ <i>Height</i> mm 14/16,30 - Per differenziale/ <i>For differential</i> | Daily Eurotrakker Eurotrakker Cursor |
|  | | | |
| 101581 | 40102133 40100453 40102130 40100450 012015510B0 | - Viton FPM - Interno/ <i>Internal</i> Ø mm 65 - Esterno/ <i>External</i> Ø mm 100 - Altezza/ <i>Height</i> mm 14 - Per differenziale/ <i>For differential</i> | Turbodaily Eurocargo |
|  | | | |
| 101609 | 595985 012011496B0 | - NBR - Interno/ <i>Internal</i> Ø mm 35 - Esterno/ <i>External</i> Ø mm 55 - Altezza/ <i>Height</i> mm 10 - Per cambio/ <i>For gear box</i> | Zeta |
|  | | | |
| 101608 | 40000583 40000580 4594821 2961985 012011459B0 | - Polyacril ACM - Interno/ <i>Internal</i> Ø mm 42 - Esterno/ <i>External</i> Ø mm 62 - Altezza/ <i>Height</i> mm 10 - Per cambio/ <i>For gear box</i> | Turbozeta Zeta |
|  | | | |



ANELLI PARAOLIO
OIL SEALS
PARE-HUILES
WELLENDICHTRINGE
САЛЬНИКИ
RETEN

EMMERRE
spare parts for trucks and trailers

IVECO

| Applicazioni / Applications | Dettagli / Detail | Adattabile a / Adaptable to | Emmerre |
|---|--|---|---------------|
| OM | - Polyacryl ACM - Interno/Internal Ø mm 50 - Esterno/External Ø mm 80 - Altezza/Height mm 10 - Per cambio/For gear box | 40001320 543637 40001580 40001321 012011281B0 | 101606 |
| OM 40/35 50.14 60.14 70.14 75.14 79.14 80-90-100NC 115-135.14/17 Zeta | - Polyacryl ACM - Interno/Internal Ø mm 62 - Esterno/External Ø mm 80 - Altezza/Height mm 10 - Per cambio/For gear box | 40000283 40000280 4597462 012011433B0 | 101603 |
| 80 90 110NC 684-160 Eurotech Eurotrakker Stralis Zeta | - Polyacryl ACM - Interno/Internal Ø mm 55 - Esterno/External Ø mm 80 - Altezza/Height mm 10 - Per cambio/For gear box | 40000520 42486609 012011282B0 | 101605 |
| Eurocargo Tector Restyling | - Viton FPM - Interno/Internal Ø mm 65 - Esterno/External Ø mm 85 - Altezza/Height mm 13 - Per cambio/For gear box | 40100503 42538259 40100501 012014424B0 | 101613 |



| Emmerre | Adattabile a / Adaptable to | Dettagli / Detail | Applicazioni / Applications |
|---|---|--|---|
| 101607 | 40000490 012011466B0 | - Polyacryl ACM - Interno/ <i>Internal</i> Ø mm 55 - Esterno/ <i>External</i> Ø mm 72 - Altezza/ <i>Height</i> mm 12 - Per cambio/ <i>For gear box</i> | 682 690 |
|  | | | |
| 101600 | 40001670 012011302B0 | - Polyacryl ACM - Interno/ <i>Internal</i> Ø mm 80 - Esterno/ <i>External</i> Ø mm 110 - Altezza/ <i>Height</i> mm 13 - Per cambio/ <i>For gear box</i> | 619-697-300 |
|  | | | |
| 101545 | 40002160 40000620 0120302B0 | - Polyacryl ACM - Interno/ <i>Internal</i> Ø mm 80 - Esterno/ <i>External</i> Ø mm 110 - Altezza/ <i>Height</i> mm 13 - Per differenziale/ <i>For differential</i> | 619-696-300 682N3/NA |
|  | | | |
| 101408 | 40102173 40102170 40102174 012016062B0 | - Viton FPM - Interno/ <i>Internal</i> Ø mm 80 - Esterno/ <i>External</i> Ø mm 100 - Altezza/ <i>Height</i> mm 12 - Per differenziale/ <i>For differential</i> | Eurocargo Eurotrakker Cursor Trakker |
|  | | | |

ANELLI PARAOLIO
OIL SEALS
PARE-HUILES
WELLENDICHTRINGE
САЛЬНИКИ
RETEN

EMMERRE
spare parts for trucks and trailers

IVECO

| Applicazioni / Applications | Dettagli / Detail | Adattabile a / Adaptable to | Emmerre |
|---|---|--|---------------|
| Eurocargo Tector Eurotech Eurostar Cursor Stralis | - Viton FPM - Interno/Internal Ø mm 110,23 - Esterno/External Ø mm 145 - Altezza/Height mm 10/12 - Per differenziale/For differential | 42534850 42538856 42560428 01031695B0 | 101588 |
| | |  | |
| Turbostar Turbotech Eurotech Eurotrakker Eurostar | - Polyacryl ACM - Interno/Internal Ø mm 76,20 - Esterno/External Ø mm 101,60 - Altezza/Height mm 11,50 - Per cambio/For gear box | 8121803 9931099 9985197 012012293B0 | 101610 |
| | |  | |
| Turbostar Turbotech Eurotech Eurotrakker Eurostar | - Viton FPM - Interno/Internal Ø mm 95,30 - Esterno/External Ø mm 114,29 - Altezza/Height mm 11,88 - Per cambio/For gear box | 1905085 42090441 42490447 012012235B0 | 101611 |
| | |  | |
| Turbostar Turbotech Eurotech Eurostar Eurotrakker | - Polyacryl ACM - Interno/Internal Ø mm 82,61 - Esterno/External Ø mm 139,70 - Altezza/Height mm 16,50-19,40 - Per differenziale/For differential | 7984287 42531764 012006484B0 | 101587 |
| | |  | |

MoZZi Ruota
Wheel Hubs

| Emmerre | Adattabile a / Adaptable to | Dettagli / Detail | Applicazioni / Applications |
|---|---|--|--|
| 101583 | 40101623 40101620 012015744B0 | - Viton FPM - Interno/ <i>Internal</i> Ø mm 90 - Esterno/ <i>External</i> Ø mm 130 - Altezza/ <i>Height</i> mm 14 - Per differenziale/ <i>For differential</i> | Eurotrakker Trakker |
|  | | | |
| 101522 | 40101540 | - NBR - Interno/ <i>Internal</i> Ø mm 166 - Esterno/ <i>External</i> Ø mm 186 - Altezza/ <i>Height</i> mm 15/23 - Per sospensioni/ <i>For suspension</i> | Eurotrakker Cursor |
|  | | | |
| 101410 | 40101023 40101021 40101020 012015505B0 | - Viton FPM - Interno/ <i>Internal</i> Ø mm 80 - Esterno/ <i>External</i> Ø mm 120 - Altezza/ <i>Height</i> mm 15 - Per differenziale/ <i>For differential</i> | Eurotrakker Cursor Trakker Eurocargo |
|  | | | |
| 101409 | 40100963 40100960 012025517B0 | - Viton FPM - Interno/ <i>Internal</i> Ø mm 90 - Esterno/ <i>External</i> Ø mm 115 - Altezza/ <i>Height</i> mm 15 - Per differenziale/ <i>For differential</i> | Eurotrakker Cursor |
|  | | | |

ANELLI PARAOLIO
OIL SEALS
PARE-HUILES
WELLENDICHTRINGE
САЛЬНИКИ
RETEN

EMMERRE
spare parts for trucks and trailers

IVECO

| Applicazioni / Applications | Dettagli / Detail | Adattabile a / Adaptable to | Emmerre |
|-----------------------------|---|-----------------------------|---------------|
| Eurotrakker Cursor | - Viton FPM | 40102693 | 101499 |
| Stralis | - Interno/Internal Ø mm 130 | 40102690 | |
| Trakker | - Esterno/External Ø mm 160 | 012029820B0 | |
| Eurotech | - Altezza/Height mm 14 - Per cambio/For gear box | | |





Mozi Ruota
Wheel Hubs

| Emmerre | Adattabile a / Adaptable to | Dettagli / Detail | Applicazioni / Applications |
|---|-----------------------------|---|----------------------------------|
| 101406 | 06562890038 012011419B0 | - NBR - Anteriore e posteriore/ <i>Front and rear</i> - Interno/ <i>Internal</i> Ø mm 125 - Esterno/ <i>External</i> Ø mm 150 - Altezza/ <i>Height</i> mm 13 - Per mozzo ruota/ <i>For wheel hub</i> | Trucks |
|  | | | |
| 101613 | 81965030229 012014424B0 | - Viton FPM - Interno/ <i>Internal</i> Ø mm 65 - Esterno/ <i>External</i> Ø mm 85 - Altezza/ <i>Height</i> mm 13 - Per cambio/ <i>For gear box</i> | F 90 L 2000 M 2000 M 90 |
|  | | | |
| 101611 | 81965020451 012012235B0 | - Viton FPM - Interno/ <i>Internal</i> Ø mm 95,30 - Esterno/ <i>External</i> Ø mm 114,29 - Altezza/ <i>Height</i> mm 11,88 - Per cambio/ <i>For gear box</i> | F 90 |
|  | | | |
| 101552 | 81965030333 019036785B0 | - Interno/ <i>Internal</i> Ø mm 132 - Esterno/ <i>External</i> Ø mm 172 - Altezza/ <i>Height</i> mm 12 - Viton FPM - Per mozzo ruota/ <i>For wheel hub</i> - Con ABS/ <i>With ABS</i> | TGA |
|  | | | |

ANELLI PARAOLIO
OIL SEALS
PARE-HUILES
WELLENDICHTRINGE
САЛЬНИКИ
RETEN

EMMERRE
spare parts for trucks and trailers

MAN

| Applicazioni / Applications | Dettagli / Detail | Adattabile a / Adaptable to | Emmerre |
|---|--|-----------------------------|---------------|
| 2000 M/L TGA TGM | <ul style="list-style-type: none"> - Interno/Internal Ø mm 130,20 - Esterno/External Ø mm 160,30 - Altezza/Height mm 10 - Viton FPM - Per mozzo ruota/For wheel hub | 06562890387 012020156B0 | 101556 |
|  | | | |
| Connessione / Connected:  931101 | | | |

Mozzi Ruota
Wheel Hubs

| Emmerre | Adattabile a / Adaptable to | Dettagli / Detail | Applicazioni / Applications |
|---|---|--|--|
| 101403 | 0199975847 0029978447 0029978547 012011411B0 | - NBR - Anteriore e posteriore/ <i>Front and rear</i> - Interno/ <i>Internal</i> Ø mm 75 - Esterno/ <i>External</i> Ø mm 100 - Altezza/ <i>Height</i> mm 13 - Per mozzo ruota/ <i>For wheel hub</i> | 809 - 811 813 - 814 817 - 913 914 - 917 1013 - 1017 1114 - 1117 1120 |
|  | | | |
| 101568 | 9403500335 A6243560080 | - Kit guarnizioni/ <i>Revision gaskets kit</i> - Assale posteriore/ <i>Rear Axle</i> | Atego I - Atego II Actros - Actros MP2 Axor - Axor II LK - LP MK - NG - SK Unimog (Bus) |
|  | | | |
| 101569 | 9403500335 A6593500135 | - Kit guarnizioni/ <i>Revision gaskets kit</i> - Assale posteriore/ <i>Rear Axle</i> | Atego I - Atego II Actros - Actros MP2 Axor - Axor II LK - LP MK - NG - SK Unimog (Bus) |
|  | | | |
| 101593 | 9403500335 A6243560080 | - Kit completo/ <i>Complete Kit</i> - Assale posteriore/ <i>Rear Axle</i> - Kit guarnizioni/ <i>Gaskets kit</i> - Con anelli scorrimento mozzo ruota/ <i>With sliding rings for wheel hub</i> | Atego I - Atego II Actros - Actros MP2 Axor - Axor II LK - LP MK - NG - SK Unimog (Bus) |
|  | | | |

ANELLI PARAOLIO
OIL SEALS
PARE-HUILES
WELLENDICHTRINGE
САЛЬНИКИ
RETEN

EMMERRE
spare parts for trucks and trailers

MERCEDES

| Applicazioni / Applications | Dettagli / Detail | Adattabile a / Adaptable to | Emmerre |
|--|---|--|---------------|
| Atego I - Atego II Actros - Actros MP2 Axor - Axor II LK - LP MK - NG - SK Unimog (Bus) | - Kit completo/Complete Kit - Assale posteriore/Rear Axle - Con anelli scorrimento mozzo ruota/ With sliding rings for wheel hub | 9403500035 A6593500135 | 101598 |
| | |  | |
| Atego I - Atego II Actros - Actros MP2 Axor - Axor II LK - LP MK - NG - SK Unimog (Bus) | - Anello scorrimento mozzo ruota/ Sliding ring for wheel hub | 3463560315 3463561415 9423560415 | 101589 |
| | |  | |
| Connessione / Connected:  101593-101598 | | | |





Mozzi Ruota
Wheel Hubs

| Emmerre | Adattabile a / <i>Adaptable to</i> | Dettagli / <i>Detail</i> | Applicazioni / <i>Applications</i> |
|--|--|---|------------------------------------|
| <p>101612</p>  | <p>32112MB90A 012030146B0</p> | <p>- Viton FPM - Interno/<i>Internal</i> Ø mm 42 - Esterno/<i>External</i> Ø mm 76 - Altezza/<i>Height</i> mm 10</p> | <p>Cabstar</p> |
| | | | |
| | | | |
| | | | |

ANELLI PARAOLIO
OIL SEALS
PARE-HUILES
WELLENDICHRINGE
САЛЬНИКИ
RETEN

EMMERRE
spare parts for trucks and trailers

RENAULT

| Applicazioni / Applications | Dettagli / Detail | Adattabile a / Adaptable to | Emmerre |
|-----------------------------|--|---|---|
| Magnum E. Tec Premium | <ul style="list-style-type: none"> - Cuoio/Leather - Interno/Internal Ø mm 117,50 - Esterno/External Ø mm 152,40 - Altezza/Height mm 21 - Per mozzo ruota/For wheel hub - Originale Stemco/Original Stemco | -- | 931317 |
| | | |  |
| Mascott | <ul style="list-style-type: none"> - Viton FPM - Interno/Internal Ø mm 42 - Esterno/External Ø mm 76 - Altezza/Height mm 10 - Per cambio/For gear box | 5001847404 012030146B0 | 101612 |
| | | |  |
| Trucks | <ul style="list-style-type: none"> - Viton FPM - Interno/Internal Ø mm 65 - Esterno/External Ø mm 85 - Altezza/Height mm 13 - Per cambio/For gear box | 5000824292 012014424B0 | 101613 |
| | | |  |
| Major | <ul style="list-style-type: none"> - Viton FPM - Interno/Internal Ø mm 95,30 - Esterno/External Ø mm 114,29 - Altezza/Height mm 11,88 - Per cambio/For gear box | 5000814109 5001831130 012012235B0 | 101611 |
| | | |  |

Mozzi Ruota
Wheel Hubs

| Emmerre | Adattabile a / <i>Adaptable to</i> | Dettagli / <i>Detail</i> | Applicazioni / <i>Applications</i> |
|--|--|--|--|
| <p>101537</p>  | <p>5010368901 012018944B0</p> | <p>- NBR - Lato interno/<i>Internal side</i> - Interno/<i>Internal</i> Ø mm 117,48 - Esterno/<i>External</i> Ø mm 152,36 - Altezza/<i>Height</i> mm 22</p> | <p>Magnum Premium</p> |
| | | | |
| | | | |
| | | | |

ANELLI PARAOLIO
OIL SEALS
PARE-HUILES
WELLENDICHRINGE
САЛЬНИКИ
RETEN

EMMERRE
spare parts for trucks and trailers

ROR

| Applicazioni / Applications | Dettagli / Detail | Adattabile a / Adaptable to | Emmerre |
|---|--|-----------------------------|---------------|
| Axle Series TE 9000 9 ton | - NBR - Interno/Internal Ø mm 100 - Esterno/External Ø mm 135 - Altezza/Height mm 13/15 - Per mozzo ruota/For wheel hub | 21220158 | 101538 |
|  Connessione / Connected: 931503-931503/N-931524 | | | |
| Axle Series TM - LM Series TA - TE | - NBR - Lato interno/Internal side - Interno/Internal Ø mm 117,48 - Esterno/External Ø mm 152,36 - Altezza/Height mm 22 - Per mozzo ruota/For wheel hub | 21200321A 012018944B0 | 101537 |
|  931508/N-931521-931522-931523-931527-931528-931536 Connessione / Connected: 931507-931501-931502-931505-931506-931508-931507/N-931501/N-931502/N-931505/N-931506/N | | | |
| Axle Series TM | - NBR - Lato interno/Internal side - Interno/Internal Ø mm 117 - Esterno/External Ø mm 152 - Altezza/Height mm 27 - Per mozzo ruota/For wheel hub | 21200321B | 101548 |
|  Connessione / Connected: 931500-931504-931500/N-931504/N-931525-931526 | | | |



| Emmerre | Adattabile a / <i>Adaptable to</i> | Dettagli / <i>Detail</i> | Applicazioni / <i>Applications</i> |
|--|------------------------------------|---|------------------------------------|
| 101406 | 4343000800 012011419B0 | - NBR - Anteriore e posteriore/ <i>Front and Rear</i> - Interno/ <i>Internal</i> Ø mm 125 - Esterno/ <i>External</i> Ø mm 150 - Altezza/ <i>Height</i> mm 13 - Per mozzo ruota/ <i>For wheel hub</i> | Axle |
|  | | | |
| 101510 | 4373000600 012011379B0 | - NBR - Posteriore/ <i>Rear</i> - Lato interno/ <i>Internal side</i> - Interno/ <i>Internal</i> Ø mm 180 - Esterno/ <i>External</i> Ø mm 200 - Altezza/ <i>Height</i> mm 15 - Per mozzo ruota/ <i>For wheel hub</i> | Axle |
|  | | | |

ANELLI PARAOLIO
OIL SEALS
PARE-HUILES
WELLENDICHTRINGE
САЛЬНИКИ
RETEN

EMMERRE
spare parts for trucks and trailers

SCANIA

| Applicazioni / Applications | Dettagli / Detail | Adattabile a / Adaptable to | Emmerre |
|--|---|---|--|
| 93 112 113 142 - 2° Series 143 | - NBR - Anteriore/ <i>Front</i> - Interno/ <i>Internal</i> Ø mm 117,47 - Esterno/ <i>External</i> Ø mm 142,87 - Altezza/ <i>Height</i> mm 12,7 - Per mozzo ruota/ <i>For wheel hub</i> | 173320 012011073B0 | 101526 |
| | | |  |
| Axle AD90 93/112/113/124 142/143/144 Series 3 Series 4 | - NBR - Posteriore/ <i>Rear</i> - Interno/ <i>Internal</i> Ø mm 145 - Esterno/ <i>External</i> Ø mm 170 - Altezza/ <i>Height</i> mm 15/20 - Per mozzo ruota/ <i>For wheel hub</i> | 370076 291076 120310 012011388B0 | 101529 |
| | | |  |
| 93 112 113 142 143 Trilox Series 3 | - NBR - Posteriore/ <i>Rear</i> - Lato interno/ <i>Internal side</i> - Interno/ <i>Internal</i> Ø mm 150,81 - Esterno/ <i>External</i> Ø mm 177,80 - Altezza/ <i>Height</i> mm 12,7 | 159496 012011092B0 | 101527 |
| | | |  |

Mozzi Ruota
Wheel Hubs

| Emmerre | Adattabile a / <i>Adaptable to</i> | Dettagli / <i>Detail</i> | Applicazioni / <i>Applications</i> |
|--|------------------------------------|--|------------------------------------|
| <p>101539</p>  | <p>013682 01016766B0</p> | <p>- NBR - Lato interno/<i>Internal side</i> - Interno/<i>Internal</i> Ø mm 115 - Esterno/<i>External</i> Ø mm 136,7 - Altezza/<i>Height</i> mm 8/10,5 - Per mozzo ruota/<i>For wheel hub</i></p> | <p>Schmitz Cargobull</p> |
| | | | |
| | | | |
| | | | |

ANELLI PARAOLIO
OIL SEALS
PARE-HUILES
WELLENDICHTRINGE
САЛЬНИКИ
RETEN

EMMERRE
spare parts for trucks and trailers

SMB

| Applicazioni / Applications | Dettagli / Detail | Adattabile a / Adaptable to | Emmerre |
|-----------------------------|---|-----------------------------|---------------|
| Axle Acerbi Viberti | <ul style="list-style-type: none"> - NBR - Lato interno/Internal side - Interno/Internal Ø mm 108 - Esterno/External Ø mm 152,60/160 - Altezza/Height mm 17 - Per mozzo ruota/For wheel hub | 449443 M100419 | 101590 |



Mozzi Ruota
Wheel Hubs

EMMERRE

spare parts for trucks and trailers

VOLVO

ANELLI PARAOLIO
OIL SEALS
PARE-HUILES
WELLENDICHTRINGE
САЛЬНИКИ
RETEN

| Emmerre | Adattabile a / Adaptable to | Dettagli / Detail | Applicazioni / Applications |
|--|-----------------------------|---------------------------------|-----------------------------|
| 101536 | 3090331 | - NBR | F 10 |
| | 1610078 | - Posteriore/Rear | F 12 |
|  | 311432 | - Lato esterno/External side | FL 6 |
| | 012013127B0 | - Interno/Internal Ø mm 77/98,4 | FL 7 |
| | | - Esterno/External Ø mm 103/6,3 | FL 10 |
| | | - Altezza/Height mm 19,3 | FL 12 |
| | | - Per mozzo ruota/For wheel hub | FH 12 |
| | | | FH 16 |
| Connessione / Connected:  | | | 931419 |
| 101534 | 1089552 | - Viton FPM | F 10 |
| | 1587792 | - Anteriore/Front | F 12 |
|  | 012014742B0 | - Interno/Internal Ø mm 110 | F 16 |
| | | - Esterno/External Ø mm 140 | FL 6 |
| | | - Altezza/Height mm 12/19 | FL 7 |
| | | - Per mozzo ruota/For wheel hub | FL 10 |
| | | | FL 12 |
| | | | FH 12 |
| | | | FH 16 |
| | | | FM 7 - 9 |
| 101535 | 1577624 | - NBR | F 7 |
| | 944667 | - Anteriore/Front | F 10 |
|  | 012011387B0 | - Lato esterno/External side | F 12 |
| | | - Interno/Internal Ø mm 133,35 | N 10 |
| | | - Esterno/External Ø mm 155,60 | |
| | | - Altezza/Height mm 14 | |
| | | - Per mozzo ruota/For wheel hub | |
| 101533 | 1672283 | - Viton FPM | F 10 |
| | 1522374 | - FKM | F 12 |
|  | 1522372 | - Posteriore/Rear | F 16 |
| | 1672249 | - Interno/Internal Ø mm 140 | FL 10 |
| | | - Esterno/External Ø mm 164 | FL 12 |
| | | - Altezza/Height mm 20/23,50 | FM 7 - 10 - 12 |
| | | - Per mozzo ruota/For wheel hub | FH 12 - FH 16 |
| | | | N 10 |

ANELLI PARAOLIO
OIL SEALS
PARE-HUILES
WELLENDICHTRINGE
САЛЬНИКИ
RETEN

EMMERRE
spare parts for trucks and trailers

VOLVO

| Applicazioni / Applications | Dettagli / Detail | Adattabile a / Adaptable to | Emmerre |
|--|---|-----------------------------------|---------------|
| F 7-10-12-16 FL 7-10-12 FH 12-16 N 10 | - Viton FPM - Posteriore/Rear - Interno/Internal Ø mm 168 - Esterno/External Ø mm 188/192,5 - Altezza/Height mm 30 - Per mozzo ruota/For wheel hub | 1610765 1591903 012014437B0 | 101532 |



| Connessione / Connected: | |
|--|--|
|  931419 | |

| | | | |
|------|---|------------------------|---------------|
| FL 6 | - Polyacryl ACM - Interno/Internal Ø mm 55 - Esterno/External Ø mm 80 - Altezza/Height mm 10 | 9587262 012011282B0 | 101605 |
|------|---|------------------------|---------------|



| | | | |
|----|---|------------------------|---------------|
| -- | - Viton FPM - Interno/Internal Ø mm 65 - Esterno/External Ø mm 85 - Altezza/Height mm 13 | 6797452 012014424B0 | 101613 |
|----|---|------------------------|---------------|



| | | | |
|------------|---|------------------------|---------------|
| FL FM 9 | - Viton FPM - Interno/Internal Ø mm 110,23 - Esterno/External Ø mm 145 - Altezza/Height mm 10/12 | 20832385 01031695B0 | 101588 |
|------------|---|------------------------|---------------|



Emmerre

Adattabile a / *Adaptable to*



Dettagli / *Detail*

Applicazioni / *Applications*

SENSORI ABS
ABS SENSORS
ABS DÉTECTEUR
ABS SENSOREN
Датчиков
ABS SENSORES

EMMERRE
 spare parts for trucks and trailers

BPW

| Applicazioni / Applications | Dettagli / Detail | Adattabile a / Adaptable to | Emmerre |
|-----------------------------|--|--|---------------|
| Axles | <ul style="list-style-type: none"> - Sensore ABS/ABS sensor - Con boccia/With bush - Con tubetto di grasso/With grease - Lunghezza/length 350 mm | 0233170700 044103244300 | 961372 |
| | |  | |
| Axles | <ul style="list-style-type: none"> - Sensore ABS/ABS sensor - Con boccia/With bush - Con tubetto di grasso/With grease - Lunghezza/length 400 mm | 0233170500 044103292120 | 961371 |
| | |  | |
| | | | |
| | | | |







Mozzi Ruota
 Wheel Hubs

| Emmerre | Adattabile a / <i>Adaptable to</i> | Dettagli / <i>Detail</i> | Applicazioni / <i>Applications</i> |
|---|--|---|------------------------------------|
| 961371 | 0082826 044103292120 0865038 0876714 1778552 1616874 1359834 | - Sensore ABS/ <i>ABS sensor</i> - Con boccia/ <i>With bush</i> - Con tubetto di grasso/ <i>With grease</i> - Lunghezza/ <i>length</i> 400 mm | Trucks |
|  | | | |
| 961373 | 1518722 044103208300 | - Sensore ABS/ <i>ABS sensor</i> - Con boccia/ <i>With bush</i> - Con tubetto di grasso/ <i>With grease</i> - Lunghezza/ <i>length</i> 2000 mm | Trucks |
|  | | | |
| 961375 | 1524830 044103286300 | - Sensore ABS/ <i>ABS sensor</i> - Con boccia/ <i>With bush</i> - Con tubetto di grasso/ <i>With grease</i> - Lunghezza/ <i>length</i> 2500 mm | Trucks |
|  | | | |
| 961379 | 1524828 044103285800 | - Sensore ABS/ <i>ABS sensor</i> - Con boccia/ <i>With bush</i> - Con tubetto di grasso/ <i>With grease</i> - Lunghezza/ <i>length</i> 2050 mm | Trucks |
|  | | | |





SENSORI ABS
ABS SENSORS
ABS DÉTECTEUR
ABS SENSOREN
Датчиков
ABS SENSORES

EMMERRE
 spare parts for trucks and trailers

DAF

| Applicazioni / Applications | Dettagli / Detail | Adattabile a / Adaptable to | | Emmerre |
|---------------------------------------|--|---|--|---|
| 65/75 CF 85CF LF55 XF 95/105 | - Sensore ABS/ABS sensor - Con boccola/With bush - Con tubetto di grasso/With grease - Lunghezza/length 260 mm | 1778554 1361393 1778553 1315691 1238561 1230594 | 044103276600 044103258100 044103217200 | 961368 |
| | |  | |  |
| 95XF | - Sensore ABS/ABS sensor - Con boccola/With bush - Con tubetto di grasso/With grease - Lunghezza/length 1040 mm | 1506003 044103287900 | | 961318 |
| | |  | |  |
| Trucks | - Sensore ABS/ABS sensor - Con boccola/With bush - Con tubetto di grasso/With grease - Lunghezza/length 350 mm | 1506004 1506007 044103244300 | | 961372 |
| | |  | | |
| Trucks | - Sensore ABS/ABS sensor - Con boccola/With bush - Con tubetto di grasso/With grease - Lunghezza/length 1000 mm | 1506006 044103292220 1504929 | | 961370 |
| | |  | | |







Mozzi Ruota
 Wheel Hubs

| Emmerre | Adattabile a / Adaptable to | Dettagli / Detail | Applicazioni / Applications |
|--|---|--|-----------------------------|
| 961366   | 1518008 1505215 1531886 044103282300 | - Sensore ABS/ABS sensor - Con boccola/With bush - Con tubetto di grasso/With grease - Lunghezza/length 2080 mm | 85CF |
| 961367   | 1400071 1506149 1525416 044103296820 044103244400 044103290000 | - Sensore ABS/ABS sensor - Con boccola/With bush - Con tubetto di grasso/With grease - Lunghezza/length 1850 mm | LF 45/55 |
| | | | |
| | | | |

SENSORI ABS
ABS SENSORS
ABS DÉTECTEUR
ABS SENSOREN
Датчиков
ABS SENSORES

EMMERRE
 spare parts for trucks and trailers

IVECO





| Applicazioni / Applications | Dettagli / Detail | Adattabile a / Adaptable to | Emmerre |
|------------------------------------|--|-----------------------------|--|
| Daily 2006/2014 | - Sensore ABS/ABS sensor - Lunghezza/length 1250 mm | 5801279030 | 961362   |
| Daily 2011/2016 | - Sensore ABS/ABS sensor - Lunghezza/length 1250 mm | 5801279032 | 961363   |
| Daily 2006 Daily 2011/2014 | - Sensore ABS/ABS sensor - Lunghezza/length 530 mm | 5801279037 0265008430 | 961369  |
| Daily 2001/2006 Daily 2006/2011 | - Sensore ABS/ABS sensor - Con boccola/With bush - Con tubetto di grasso/With grease - Lunghezza/length 1300 mm | 504007426 500342090 | 961380  |

| Emmerre | Adattabile a / <i>Adaptable to</i> | Dettagli / <i>Detail</i> | Applicazioni / <i>Applications</i> |
|---------------|--|---|--|
| 961374 | 41200560 41200559 044103285600 41040148 98419510 41040149 98419511 123179 | - Sensore ABS/ <i>ABS sensor</i> - Con boccia/ <i>With bush</i> - Con tubetto di grasso/ <i>With grease</i> - Lunghezza/ <i>length</i> 1500 mm | Cursor Stralis Astra |
| 961376 | 41221297 044103233100 | - Sensore ABS/ <i>ABS sensor</i> - Con boccia/ <i>With bush</i> - Con tubetto di grasso/ <i>With grease</i> - Lunghezza/ <i>length</i> 2500 mm | Iveco trucks |
| 961375 | 41200611 044103286300 | - Sensore ABS/ <i>ABS sensor</i> - Con boccia/ <i>With bush</i> - Con tubetto di grasso/ <i>With grease</i> - Lunghezza/ <i>length</i> 2500 mm | Stralis Trakker Eurotech Eurostar |
| 961379 | 41200561 98419513 41040150 41200562 044103285800 | - Sensore ABS/ <i>ABS sensor</i> - Con boccia/ <i>With bush</i> - Con tubetto di grasso/ <i>With grease</i> - Lunghezza/ <i>length</i> 2050 mm | Stralis Astra |



SENSORI ABS
ABS SENSORS
ABS DÉTECTEUR
ABS SENSOREN
Датчиков
ABS SENSORES

EMMERRE
 spare parts for trucks and trailers

IVECO

| Applicazioni / Applications | Dettagli / Detail | Adattabile a / Adaptable to | Emmerre |
|-----------------------------|--|---|--|
| Trucks | <ul style="list-style-type: none"> - Sensore ABS/<i>ABS sensor</i> - Con boccola/<i>With bush</i> - Con tubetto di grasso/<i>With grease</i> - Lunghezza/<i>length</i> 1850 mm | 504013848 5006042708 42553667 044103296820 044103244400 044103290000 | 961367  |
| Stralis | <ul style="list-style-type: none"> - Sensore ABS/<i>ABS sensor</i> - Con boccola/<i>With bush</i> - Con tubetto di grasso/<i>With grease</i> - Lunghezza/<i>length</i> 2620 mm | 41221296 044103233000 | 961378  |
| Stralis Trakker | <ul style="list-style-type: none"> - Sensore ABS/<i>ABS sensor</i> - Con boccola/<i>With bush</i> - Con tubetto di grasso/<i>With grease</i> - Lunghezza/<i>length</i> 2160 mm | 41221280 044103298000 | 961377  |
| Trucks | <ul style="list-style-type: none"> - Sensore ABS/<i>ABS sensor</i> - Con boccola/<i>With bush</i> - Con tubetto di grasso/<i>With grease</i> - Lunghezza/<i>length</i> 400 mm | 5006041993 044103292120 | 961371  |





Mozzi Ruota
 Wheel Hubs





| Emmerre | Adattabile a / <i>Adaptable to</i> | Dettagli / <i>Detail</i> | Applicazioni / <i>Applications</i> |
|--|------------------------------------|---|------------------------------------|
| 961370 | 5006041994 044103292220 | - Sensore ABS/ <i>ABS sensor</i> - Con boccia/ <i>With bush</i> - Con tubetto di grasso/ <i>With grease</i> - Lunghezza/ <i>length</i> 1000 mm | Trucks |
|  | | | |
| 961366 | 5006010272 044103296720 | - Sensore ABS/ <i>ABS sensor</i> - Con boccia/ <i>With bush</i> - Con tubetto di grasso/ <i>With grease</i> - Lunghezza/ <i>length</i> 2080 mm | Trucks |
|  | | | |
| | | | |
| | | | |

SENSORI ABS
ABS SENSORS
ABS DÉTECTEUR
ABS SENSOREN
Датчиков
ABS SENSORES

EMMERRE
 spare parts for trucks and trailers

MAN





| Applicazioni / Applications | Dettagli / Detail | Adattabile a / Adaptable to | Emmerre |
|--|--|--|---------------|
| TGA TGS TGX TGM | - Sensore ABS/ABS sensor - Lunghezza/length 2100 mm | 81271206182 044103229600 | 961382 |
|  | | | |
| TGA TGS TGX TGM | - Sensore ABS/ABS sensor - Lunghezza/length 2100 mm | 81271206183 044103229700 | 961381 |
|  | | | |
| Trucks | - Sensore ABS/ABS sensor - Con boccola/With bush - Con tubetto di grasso/With grease - Lunghezza/length 350 mm | N2255200062 N2255200060 044103244300 | 961372 |
|  | | | |
| Trucks | - Sensore ABS/ABS sensor - Con boccola/With bush - Con tubetto di grasso/With grease - Lunghezza/length 1000 mm | N2255206003 044103292220 N2955016004 | 961370 |
|  | | | |



| Emmerre | Adattabile a / Adaptable to | Dettagli / Detail | Applicazioni / Applications |
|--|--|---|-----------------------------|
| 961366  | 81271206117 044103272800 | <ul style="list-style-type: none"> - Sensore ABS/ABS sensor - Con boccia/With bush - Con tubetto di grasso/With grease - Lunghezza/length 2080 mm | Trucks |
| 961393  | 36271206005 044103248700 | <ul style="list-style-type: none"> - Sensore ABS/ABS sensor - Con boccia/With bush - Con tubetto di grasso/With grease - Lunghezza/length 3140 mm | Trucks |
| 961383  | 81271206138 81271206110 81271206164 004860001250000 | <ul style="list-style-type: none"> - Sensore ABS/ABS sensor - Con boccia/With bush - Con tubetto di grasso/With grease - Lunghezza/length 2180 mm | TGA |
| 961387  | 81271206168 00486000261N000 | <ul style="list-style-type: none"> - Sensore ABS/ABS sensor - Con boccia/With bush - Con tubetto di grasso/With grease - Lunghezza/length 1830 mm | TGA TGS |

SENSORI ABS
ABS SENSORS
ABS DÉTECTEUR
ABS SENSOREN
Датчиков
ABS SENSORES

EMMERRE
 spare parts for trucks and trailers

MAN

| Applicazioni / Applications | Dettagli / Detail | Adattabile a / Adaptable to | Emmerre |
|---------------------------------|--|--|--|
| TGA | <ul style="list-style-type: none"> - Sensore ABS/ABS sensor - Con boccola/With bush - Con tubetto di grasso/With grease - Lunghezza/length 1555 mm | 81271206097 81271206131 81271206177 004860000930000 | 961390  |
| TGA TGL TGM TGS TGX | <ul style="list-style-type: none"> - Sensore ABS/ABS sensor - Con boccola/With bush - Con tubetto di grasso/With grease - Lunghezza/length 1540 mm | 81271206176 004860002110000 81271206132 81271206098 | 961391  |
| Trucks | <ul style="list-style-type: none"> - Sensore ABS/ABS sensor - Con boccola/With bush - Con tubetto di grasso/With grease - Lunghezza/length 2000 mm | 81271200041 044103208300 | 961373  |
| TGA | <ul style="list-style-type: none"> - Sensore ABS/ABS sensor - Con boccola/With bush - Con tubetto di grasso/With grease - Lunghezza/length 2180 mm | 81271206165 81271206137 81271206111 004860001240000 | 961384  |

| Emmerre | Adattabile a / <i>Adaptable to</i> | Dettagli / <i>Detail</i> | Applicazioni / <i>Applications</i> |
|---|------------------------------------|---|------------------------------------|
| 961386  | 81271206179 044103510700 | - Sensore ABS/ <i>ABS sensor</i> - Con boccia/ <i>With bush</i> - Con tubetto di grasso/ <i>With grease</i> - Lunghezza/ <i>length</i> 1340 mm | TGL TGM |
| 961389  | 81271206105 044103534300 | - Sensore ABS/ <i>ABS sensor</i> - Con boccia/ <i>With bush</i> - Con tubetto di grasso/ <i>With grease</i> - Lunghezza/ <i>length</i> 3090 mm | TGL TGM |
| | | | |
| | | | |

SENSORI ABS
ABS SENSORS
ABS DÉTECTEUR
ABS SENSOREN
Датчиков
ABS SENSORES

EMMERRE
 spare parts for trucks and trailers

MERCEDES

| Applicazioni / Applications | Dettagli / Detail | Adattabile a / Adaptable to | Emmerre |
|--|--|--|---|
| Actros Neoplan | - Sensore ABS/ABS sensor - Con boccola/With bush - Con tubetto di grasso/With grease - Lunghezza/length 400 mm | 0025423118 044103292120 6205420217 0045422416 0045424418 | 961371 |
| Atego Actros Atego II Actros MP2/MP3 Citaro Conecto | - Sensore ABS/ABS sensor - Con boccola/With bush - Con tubetto di grasso/With grease - Lunghezza/length 2080 mm | 0005429618 0015420518 0015423118 044103272800 0015428218 0015428718 044103282300 | 961366 |
| Actros Atego Atego II Axor Axor II Actros MP2/MP3 Unimog | - Sensore ABS/ABS sensor - Con boccola/With bush - Con tubetto di grasso/With grease - Lunghezza/length 2355 mm | 0025423818 0025422718 0015428518 0015420818 044103242900 044103292200 | 961392 |
| Actros Atego Axor | - Sensore ABS/ABS sensor - Con boccola/With bush - Con tubetto di grasso/With grease - Lunghezza/length 3140 mm | 0025422318 0015428818 0015423318 0015423518 0015428418 0025422618 | 044103292100 044103292300 961393 |



EMMERRE

spare parts for trucks and trailers

MERCEDES

SENSORI ABS
ABS SENSORS
ABS DÉTECTEUR
ABS SENSOREN
Датчиков
ABS SENSORES

| Emmerre | Adattabile a / Adaptable to | Dettagli / Detail | Applicazioni / Applications |
|--|--|---|---|
| 961395  | 0025422218 0025422518 044103285100 | - Sensore ABS/ABS sensor - Con boccia/With bush - Con tubetto di grasso/With grease - Lunghezza/length 1580 mm | Actros Atego Axor |
| 961396  | 0025423718 0025422418 044103292000 0015428918 | - Sensore ABS/ABS sensor - Con boccia/With bush - Con tubetto di grasso/With grease - Lunghezza/length 2650 mm | Actros |
| 961397  | 6555400817 6505400217 | - Sensore ABS/ABS sensor - Con boccia/With bush - Con tubetto di grasso/With grease - Lunghezza/length 540 mm | Actros Actros MP2/MP3 Axor Axor II |
| 961398  | 0015427618 0015427818 044103296620 044103281300 | - Sensore ABS/ABS sensor - Con boccia/With bush - Con tubetto di grasso/With grease - Lunghezza/length 1350 mm | Atego Atego II |

SENSORI ABS
ABS SENSORS
ABS DÉTECTEUR
ABS SENSOREN
Датчиков
ABS SENSORES

EMMERRE
spare parts for trucks and trailers

MERCEDES

| Applicazioni / Applications | Dettagli / Detail | Adattabile a / Adaptable to | Emmerre |
|--|--|--|--|
| Actros Actros MP2/MP3 Atego Atego II Axor II | - Sensore ABS/ABS sensor - Con boccola/With bush - Con tubetto di grasso/With grease - Lunghezza/length 3560 mm | 0035423518 044103294100 0045424518 | 961399  |









Mozi Ruota
Wheel Hubs

EMMERRE

spare parts for trucks and trailers

RENAULT





SENSORI ABS
ABS SENSORS
ABS DÉTECTEUR
ABS SENSOREN
Датчиков
ABS SENSORES



| Emmerre | Adattabile a / Adaptable to | Dettagli / Detail | Applicazioni / Applications |
|---|--|---|-----------------------------|
| 961367   | 7420390737 044103296820 044103244400 044103290000 | - Sensore ABS/ABS sensor - Con boccia/With bush - Con tubetto di grasso/With grease - Lunghezza/length 1850 mm | Trucks |
| 961366   | 5010422334 044103272800 | - Sensore ABS/ABS sensor - Con boccia/With bush - Con tubetto di grasso/With grease - Lunghezza/length 2080 mm | Trucks |
| 961311   | 7421363493 7420916171 5010457871 044103234900 | - Sensore ABS/ABS sensor - Con boccia/With bush - Con tubetto di grasso/With grease - Lunghezza/length 5650 mm | Kerax |
| 961312   | 5010457874 7421363474 044103299500 | - Sensore ABS/ABS sensor - Con boccia/With bush - Con tubetto di grasso/With grease - Lunghezza/length 1830 mm | Magnum Premium Midlum |

SENSORI ABS
ABS SENSORS
ABS DÉTECTEUR
ABS SENSOREN
Датчиков
ABS SENSORES

EMMERRE
 spare parts for trucks and trailers

RENAULT



| Applicazioni / Applications | Dettagli / Detail | Adattabile a / Adaptable to | Emmerre |
|--------------------------------|--|--|--|
| Premium Premium II | <ul style="list-style-type: none"> - Sensore ABS/ABS sensor - Con boccola/With bush - Con tubetto di grasso/With grease - Lunghezza/length 4040 mm | 7420915973 5010457870 7421363492 7421663562 044103234800 | 961310  |
| Magnum Midlum Premium II | <ul style="list-style-type: none"> - Sensore ABS/ABS sensor - Con boccola/With bush - Con tubetto di grasso/With grease - Lunghezza/length 2090 mm | 7420916175 5010457862 7421363496 044103235100 | 961313  |
| Trucks | <ul style="list-style-type: none"> - Sensore ABS/ABS sensor - Con boccola/With bush - Con tubetto di grasso/With grease - Lunghezza/length 350 mm | 5021170124 044103244300 | 961372  |
| Trucks | <ul style="list-style-type: none"> - Sensore ABS/ABS sensor - Con boccola/With bush - Con tubetto di grasso/With grease - Lunghezza/length 400 mm | 5010604322 5021170122 5021170125 044103292120 | 961371  |

| Emmerre | Adattabile a / <i>Adaptable to</i> | Dettagli / <i>Detail</i> | Applicazioni / <i>Applications</i> |
|--|--|--|------------------------------------|
| 961370 | 5021170126 044103292220 5021170123 5010422332 5430041687 | - Sensore ABS/ <i>ABS sensor</i> - Con boccola/ <i>With bush</i> - Con tubetto di grasso/ <i>With grease</i> - Lunghezza/ <i>length</i> 1000 mm | Trucks |
|  | | | |
| 961388 | 7420509869 044103296800 | - Sensore ABS/ <i>ABS sensor</i> - Con boccola/ <i>With bush</i> - Con tubetto di grasso/ <i>With grease</i> - Lunghezza/ <i>length</i> 4300 mm | Trucks |
|  | | | |

SENSORI ABS
ABS SENSORS
ABS DÉTECTEUR
ABS SENSOREN
Датчиков
ABS SENSORES

EMMERRE
 spare parts for trucks and trailers

SAF







| Applicazioni / Applications | Dettagli / Detail | Adattabile a / Adaptable to | Emmerre |
|-----------------------------|--|--|--|
| Axle | <ul style="list-style-type: none"> - Sensore ABS/ABS sensor - Con boccola/With bush - Con tubetto di grasso/With grease - Lunghezza/length 1040 mm | 3029023300 4029106400 044103287900 | 961318  |
| Axle | <ul style="list-style-type: none"> - Sensore ABS/ABS sensor - Con boccola/With bush - Con tubetto di grasso/With grease - Lunghezza/length 1000 mm | 3029023200 040291042000 | 961370  |
| Axle | <ul style="list-style-type: none"> - Sensore ABS/ABS sensor - Con boccola/With bush - Con tubetto di grasso/With grease - Lunghezza/length 400 mm | 3029023100 044103292120 | 961371  |

EMMERRE

spare parts for trucks and trailers

SCANIA



SENSORI ABS
ABS SENSORS
ABS DÉTECTEUR
ABS SENSOREN
Датчиков
ABS SENSORES

| Emmerre | Adattabile a / Adaptable to | Dettagli / Detail | Applicazioni / Applications |
|---|---|--|-----------------------------|
| 961367   | 1934574 044103296820 04410324440 044103290000 | - Sensore ABS/ABS sensor - Con boccola/With bush - Con tubetto di grasso/With grease - Lunghezza/length 1850 mm | Serie P.G.R.T. |
| 961322   | 1530704 1482006 1482007 1729800 1729798 044103299320 | - Sensore ABS/ABS sensor - Con boccola/With bush - Con tubetto di grasso/With grease - Lunghezza/length 1830 mm | Serie 4 Serie P.G.R.T. |
| 961323   | 1431120 1431118 1360615 1892054 044103272900 1530700 044103291000 | - Sensore ABS/ABS sensor - Con boccola/With bush - Con tubetto di grasso/With grease - Lunghezza/length 1250 mm | Serie P.G.R.T. |
| 961372  | 1784590 044103244300 044103296320 | - Sensore ABS/ABS sensor - Con boccola/With bush - Con tubetto di grasso/With grease - Lunghezza/length 350 mm | Trucks |

SENSORI ABS
ABS SENSORS
ABS DÉTECTEUR
ABS SENSOREN
Датчиков
ABS SENSORES

EMMERRE
 spare parts for trucks and trailers

SCANIA

| Applicazioni / Applications | Dettagli / Detail | Adattabile a / Adaptable to | Emmerre |
|-----------------------------|--|--|---------------|
| Trucks | <ul style="list-style-type: none"> - Sensore ABS/ABS sensor - Con boccola/With bush - Con tubetto di grasso/With grease - Lunghezza/length 400 mm | 1784588 044103292120 | 961371 |
| | |  | |
| Trucks | <ul style="list-style-type: none"> - Sensore ABS/ABS sensor - Con boccola/With bush - Con tubetto di grasso/With grease - Lunghezza/length 1000 mm | 1738458 044103292220 1506006 1934569 | 961370 |
| | |  | |
| | | | |
| | | | |

Mozzi Ruota
 Wheel Hubs

| Emmerre | Adattabile a / <i>Adaptable to</i> | Dettagli / <i>Detail</i> | Applicazioni / <i>Applications</i> |
|--|---|---|------------------------------------|
| <p>961371</p>  | <p>050019 044103280800 044103292120</p> | <p>- Sensore ABS/<i>ABS sensor</i> - Con boccia/<i>With bush</i> - Con tubetto di grasso/<i>With grease</i></p> | <p>Axle</p> |
| | | | |
| | | | |
| | | | |

SENSORI ABS
ABS SENSORS
ABS DÉTECTEUR
ABS SENSOREN
Датчиков
ABS SENSORES

EMMERRE
 spare parts for trucks and trailers

VOLVO





| Applicazioni / Applications | Dettagli / Detail | Adattabile a / Adaptable to | Emmerre |
|--------------------------------------|--|--|---------------|
| FH 12 FH 16 | - Sensore ABS/ABS sensor - Con boccola/With bush - Con tubetto di grasso/With grease - Lunghezza/length 4300 mm | 21247161 20509869 20554956 044103296800 | 961388 |
| FH 12/16 FE FL FM B 9/12 | - Sensore ABS/ABS sensor - Con boccola/With bush - Con tubetto di grasso/With grease - Lunghezza/length 2730 mm | 21296833 21247147 21247154 20528660 21097072 044103238600 20528657 20528653 | 961330 |
| FE FL FL II | - Sensore ABS/ABS sensor - Con boccola/With bush - Con tubetto di grasso/With grease - Lunghezza/length 1830 mm | 20723702 20916177 21363497 21363474 044103299500 | 961312 |
| FE /FE II FL /FL II FL III | - Sensore ABS/ABS sensor - Con boccola/With bush - Con tubetto di grasso/With grease - Lunghezza/length 2090 mm | 21663166 20916175 21363496 044103235100 | 961313 |

EMMERRE

spare parts for trucks and trailers

VOLVO

SENSORI ABS
ABS SENSORS
ABS DÉTECTEUR
ABS SENSOREN
Датчиков
ABS SENSORES

| Emmerre | Adattabile a / Adaptable to | Dettagli / Detail | Applicazioni / Applications | |
|--|--|---|---|-----------------------------------|
| 961328  | 20528661 044103295700 20528658 | - Sensore ABS/ABS sensor - Con boccia/With bush - Con tubetto di grasso/With grease - Lunghezza/length 2730 mm | FH | |
| 961329  | 20566832 20428941 20428942 20428948 20428949 044103297620 | - Sensore ABS/ABS sensor - Con boccia/With bush - Con tubetto di grasso/With grease - Lunghezza/length 1770 mm | FH 12/16 FM 7/9/12 FL | |
| 961367  | 044103296820 044103244400 044103290000 | 20390737 20442752 20442753 20442755 21361902 3988330 | - Sensore ABS/ABS sensor - Con boccia/With bush - Con tubetto di grasso/With grease - Lunghezza/length 1850 mm | FH 12/16 FM 9/12 FL6 B12 |
| 961310  | 21663562 21663563 044103234800 | 20732820 20915973 21363492 21663168 21663169 | - Sensore ABS/ABS sensor - Con boccia/With bush - Con tubetto di grasso/With grease - Lunghezza/length 4040 mm | FE |

SENSORI ABS
ABS SENSORS
ABS DÉTECTEUR
ABS SENSOREN
Датчиков
ABS SENSORES

EMMERRE
 spare parts for trucks and trailers

VOLVO

| Applicazioni / Applications | Dettagli / Detail | Adattabile a / Adaptable to | Emmerre |
|-----------------------------|--|--|---|
| FE | <ul style="list-style-type: none"> - Sensore ABS/<i>ABS sensor</i> - Con boccola/<i>With bush</i> - Con tubetto di grasso/<i>With grease</i> - Lunghezza/<i>length</i> 5650 mm | 20732821 20916171 21363493 044103234900 | 961311  |
| | | | |
| | | | |
| | | | |

Mozzi Ruota
 Wheel Hubs

Emmerre

Adattabile a / *Adaptable to*

Dettagli / *Detail*

Applicazioni / *Applications*

**ARTICOLI VARI PER MOZZI RUOTA
VARIOUS FOR WHEEL HUBS
ARTICLES POUR MOYEUX DE ROUE
ARTIKELN FÜR RADNABEN
КОМПОНЕНТЫ ДЛЯ СТУПИЦ
ARTÍCULOS PARA BUJES DE RUEDA**

EMMERRE
spare parts for trucks and trailers

BPW

| Applicazioni / Applications | Dettagli / Detail | Adattabile a / Adaptable to | Emmerre |
|---|--|-----------------------------|---------------|
| Axle | - Ruota fonica ABS /ABS ring - Ø 152 x 170 x 15 mm (80 z) | 0331008180 | 930962 |
|  NEWS | | | |
| Connesione / Connected:  931370-931371-931482-931484 | | | |
| Axle SKH - SHZF Eco plus 9010 Eco plus II SKH - SKHBM Eco Maxx | - Ruota fonica ABS /ABS ring - Ø 177 x 215 x 22 mm (100 z) | 0331009390 | 930943 |
|  NEWS | | | |
| Axle | - Ruota fonica ABS /ABS ring - Ø 177 x 215 x 22 mm (80 z) | 0331009380 | 930944 |
|  NEWS | | | |
| Axle Eco Plus | - Calotta mozzo BPW/BPW wheel hub cover - M 136 x 2,5 | 0321225310 | 930935 |
|  NEWS | | | |

Connesione / Connected:  931374-931376-931391-931392-931403-931405-931408-931421-931434

I riferimenti indicati non sono originali ma perfettamente intercambiabili. I codici originali e le case costruttrici sono indicati a puro titolo informativo
The details described are not original but perfectly interchangeable. The original references and manufacturer names are given for information purposes only.

| Emmerre | Adattabile a / Adaptable to | Dettagli / Detail | Applicazioni / Applications |
|---|-----------------------------|--|------------------------------------|
| 930936   | 0321223090 | - Calotta mozzo BPW/ BPW wheel hub cover - M 115 x 2 | Axle 6/9 Ton TG1321 |
| Connessione / Connected:  | | | 931410 |
| 930937   | 0321224250 | - Calotta mozzo BPW/ BPW wheel hub cover - M 125 x 2 | Axle Eco 8 Ton KTL |
| Connessione / Connected:  | | | 931482-931371-931393-931402-931404 |
| 930938   | 0321224070 | - Calotta mozzo/Wheel hub cover - M 125 x 2 | Axle 9/12 Ton TE1321 |
| Connessione / Connected:  | | | 931409-931418 |
| 930939   | 0521225980 | - Calotta mozzo/Wheel hub cover - M 135 x 2 | Axle Eco Plus III |
| Connessione / Connected:  | | | 931383-931399 |

**ARTICOLI VARI PER MOZZI RUOTA
VARIOUS FOR WHEEL HUBS
ARTICLES POUR MOYEURS DE ROUE
ARTIKELN FÜR RADNABEN
КОМПОНЕНТЫ ДЛЯ СТУПИЦ
ARTÍCULOS PARA BUJES DE RUEDA**

EMMERRE
spare parts for trucks and trailers

BPW

| Applicazioni / Applications | Dettagli / Detail | Adattabile a / Adaptable to | Emmerre |
|--|---|-----------------------------|---------------|
| Axle HH / HHB / HHBF / HHBFH Eco / Eco Maxx Eco Plus / Eco Plus II SKH RRZM / RRZF / RRSF KR / KRZ | - Ruota fonica ABS /ABS ring - Ø 125 x 156 x 8,5 mm (100 z) | 0331008510 | 931131 |
|  | | | |
| Connessione / Connected:  931403-931408-931398-931381-931437-931458-931460-931463 | | | |
| Axle SKH - SHZF 9010 Eco plus SKH - SKHBF 9010 Eco plus II Eco Maxx | - Ruota fonica ABS /ABS ring - Ø 105 x 152 x 22 mm (100 z) | 0531007301 0531007300 | 931114 |
|  | | | |
| Connessione / Connected:  931369-931393-931465 | | | |
| Axle Eco Seal H 10010 P/W | - Ruota fonica ABS /ABS ring - Ø 176 x 194 x 15 mm (100 z) | 0331008140 | 930960 |
|  | | | |
| Connessione / Connected:  931374-931392 | | | |
| Axle Eco M/K 10010 ELW | - Ruota fonica ABS /ABS ring - Ø 150 x 176 x 20 mm (80 z) | 0531008441 0531008440 | 930961 |
|  | | | |
| Connessione / Connected:  931391-931466 | | | |

| Emmerre | Adattabile a / Adaptable to | Dettagli / Detail | Applicazioni / Applications |
|--|-----------------------------|---|---|
| 931150 | 1396548 | - Dado mozzo posteriore/Rear hub nut - M 86 x 2 - Chiave/Key 105 mm | Euro 3/5 LF 45/55 XH 95/105 CF 75/85 |
|  | | | |
| Connessione / Connected:  931851-931852-931752-931751 | | | |
| 931125 | 1805824 1657638 | - Ruota fonica ABS /ABS ring - Ø mm 168 x 212 x 18 (100 z) | CF 75/85 Euro 3 XF 105 LF 55 |
|  | | | |
| Connessione / Connected:  931752-931852 | | | |
| 931127 | 1805823 1391517 | - Ruota fonica ABS /ABS ring - Ø mm 168 x 212 x 18 (100 z) | XF105 Euro 5 CF 65/75/85 |
|  | | | |
| Connessione / Connected:  931751-931851 | | | |
| 931123 | 1805821 1391515 | - Ruota fonica ABS /ABS ring - Ø mm 118 x 148 x 13,3 (100 z) | CF 65/75/85 XF 95 |
|  | | | |
| Connessione / Connected:  931750-931753-931758-931759-931850-931853 | | | |

ARTICOLI VARI PER MOZZI RUOTA
 VARIOUS FOR WHEEL HUBS
 ARTICLES POUR MOYEURS DE ROUE
 ARTIKELN FÜR RADNABEN
 КОМПОНЕНТЫ ДЛЯ СТУПИЦ
 ARTÍCULOS PARA BUJES DE RUEDA

EMMERRE
 spare parts for trucks and trailers

DAF

| Applicazioni / Applications | Dettagli / Detail | Adattabile a / Adaptable to | Emmerre |
|-----------------------------|--|-----------------------------|---------------|
| XF 95 CF 75/85 LF 45 | - Ruota fonica ABS / ABS ring - Ø 165 x 180 x 14 mm | 0360941 | 931147 |



| Connessione / Connected: | 931749-931754 |
|---|---------------|
|  | |

| CF / XF 75/85 95/105 LF 55 | - Calotta mozzo / Wheel hub cover | 1691965 | 931750.3 |
|-------------------------------------|-----------------------------------|---------|--|
| | | |  |

| Connessione / Connected: | 931750 |
|---|--------|
|  | |

Mozzi Ruota
Wheel Hubs

| Emmerre | Adattabile a / Adaptable to | Dettagli / Detail | Applicazioni / Applications |
|---|-----------------------------|--|--|
| 931513 | 7173032 | - Distanziale/Spacer - Esterno/External Ø mm. 54 - Interno/Internal Ø mm. 45 - Altezza/Height mm. 42 | Eurocargo Eurocargo Tector 65/75/80 100/95 |
|  | | | Connessione / Connected:  931033-931046 |
| 931514 | 7172888 | - Distanziale/Spacer - Esterno/External Ø mm. 65 - Interno/Internal Ø mm. 55 - Altezza/Height mm. 36,20 | Eurocargo Eurocargo Tector 120/130/150 320/280 |
|  | | | Connessione / Connected:  931036-931048 |
| 931515 | 7173033 | - Distanziale/Spacer - Esterno/External Ø mm. 54 - Interno/Internal Ø mm. 45 - Altezza/Height mm. 54 | Eurocargo 60/65/75 |
|  | | | Connessione / Connected:  931029 |
| 931516 | 7173733 | - Distanziale/Spacer - Esterno/External Ø mm. 85 - Interno/Internal Ø mm. 75 - Altezza/Height mm. 34,30 | Eurocargo 80/85/100 180/95 |
|  | | | |

**ARTICOLI VARI PER MOZZI RUOTA
VARIOUS FOR WHEEL HUBS
ARTICLES POUR MOYEURS DE ROUE
ARTIKELN FÜR RADNABEN
КОМПОНЕНТЫ ДЛЯ СТУПИЦ
ARTÍCULOS PARA BUJES DE RUEDA**

EMMERRE
spare parts for trucks and trailers

IVECO

| Applicazioni / Applications | Dettagli / Detail | Adattabile a / Adaptable to | Emmerre |
|---|--|-----------------------------|---------------|
| New Daily 30/35/40.8/10/12 | - Distanziale mozzo ruota/Hub spacer - Esterno/External Ø mm. 55 - Interno/Internal Ø mm. 40 - Altezza/Height mm. 12,70 | 93804575 | 931512 |
|  | | | |
| Connessione / Connected: 931003-931005 | | | |
| New Daily 30/45/49.10/12 | - Distanziale mozzo ruota/Hub spacer - Esterno/External Ø mm. 55 - Interno/Internal Ø mm. 40 - Altezza/Height mm. 10 | 8581831 | 931510 |
|  | | | |
| Connessione / Connected: 931006 | | | |
| New Daily Turbodaily '96 Daily City 2000 35/40/45/49/50.8/10/12/11 C9/C11/C13/C15 | - Anello mozzo ruota/Hub ring - Esterno/External Ø mm. 71,70 - Interno/Internal Ø mm. 52,70 - Altezza/Height mm. 3,81 | 7180040 | 962002 |
|  | | | |
| New Daily/96/2000 35/40.8/10/12 Fino 2016 | - Dado/Nut - M 52 x 1,5 - Chiave/Key 67 mm | 7180039 503691905 | 962000 |
|  | | | |

Mozzi Ruota
Wheel Hubs

| Emmerre | Adattabile a / <i>Adaptable to</i> | Dettagli / <i>Detail</i> | Applicazioni / <i>Applications</i> |
|---|------------------------------------|--|---|
| 953201 | 7184091 | - Calotta mozzo ruota/ <i>Wheel hub cover</i> - Con tappo / <i>with plug</i> - M 125 x 2 | Eurocargo 170 Eurotech Eurotrakker 400/410/440/720/ 180/190/260/340/380 Eurostar 190/240 260/440/400 Cursor Tector Stralis |
|  | | | |
| 953202 | 7184092 | - Calotta mozzo ruota/ <i>Wheel hub cover</i> - Con tappo / <i>with plug</i> - M 80 x 2 | Eurocargo 60 Eurocargo Tector |
|  | | | |
| 953200 | 7184090 | - Calotta mozzo ruota/ <i>Wheel hub cover</i> - M 100 x 2 | Eurocargo Tector |
|  | | | |
| 931098 | 7173040 | - Ruota fonica ABS / <i>ABS ring</i> - Ø 96 x 114 x 10 mm (80 z) | Eurocargo |
|  | | | |

Connessione / *Connected:*  931033-931029-931095-931104

**ARTICOLI VARI PER MOZZI RUOTA
VARIOUS FOR WHEEL HUBS
ARTICLES POUR MOYEUX DE ROUE
ARTIKELN FÜR RADNABEN
КОМПОНЕНТЫ ДЛЯ СТУПИЦ
ARTÍCULOS PARA BUJES DE RUEDA**

EMMERRE
spare parts for trucks and trailers

IVECO

| Applicazioni / Applications | Dettagli / Detail | Adattabile a / Adaptable to | Emmerre |
|--|--|-----------------------------|---------------|
| Eurocargo 150/260/170/180 Eurotrakker 190/400/260/440 330/380/720/340/Cursor410 Eurostar 400/190/440/240/260/ Cursor/Eurocargo Tector Eurotech 180/190/400/440/ Cursor/240/260 Stralis 440/260/190/180/400 Cityclass/Eurorider | - Distanziale/Spacer - Esterno/External Ø mm. 80 - Interno/Internal Ø mm. 70 - Altezza/Height mm. 52,40 | 7173030 | 931517 |



| Connessione / Connected: | 930977-930989-931084 | | |
|--------------------------|----------------------|--|--|
|--------------------------|----------------------|--|--|

| | | | |
|--|--------------------------|--------------------|---------------|
| Eurocargo 180 Tector Stralis 260/440/190 Eurotech 440 cursor Eurostar 440 cursor Eurorider | - Dado/Nut - M 88 x 2 | 7184036 7179746 | 931206 |
|--|--------------------------|--------------------|---------------|



| | | | |
|---|---|---------|---------------|
| Eurotrakker 400/190/180 330/380/720/340/410 Eurotrakker Cursor 260/440/190/330/API60 Turbocity Eurorider | - Dado/Nut - M 82 x 1,5 - Chiave/Key mm. 92 | 3555488 | 931207 |
|---|---|---------|---------------|



| | | | |
|---|---|----------|---------------|
| Eurocargo 135/150 Tector Eurotrakker 190/400 Cursor 180/260/380/720 340/410 | - Dado/Nut - M 70 x 1,5 - Chiave/Key mm. 94 | 42115022 | 931205 |
|---|---|----------|---------------|



MoZZi Ruota
Wheel Hubs

| Emmerre | Adattabile a / Adaptable to | Dettagli / Detail | Applicazioni / Applications |
|--|-----------------------------|--|---|
| 931013 | 504164176 98430602 | - Ruota fonica ABS /ABS ring - Ø 94 x 120 x 10 mm (52 z) | Daily City 2000 Daily 96 MY 2012 35/49/59.10/12/18 65C15/11/13 50C15/13/11 35S12/10/9/15/11-C12/10 /15/9/13/11 29L10/12 |
| Connessione / Connected:  931001-931019-931025-931071-931115 | | | |
| 930967 | 7172934 | - Ruota fonica ABS /ABS ring - Ø 131 x 148 x 15 mm (100 z) | Eurocargo Eurotech Eurostar Eurotrækker Stralis |
| Connessione / Connected:  931034-930981 | | | |
| 930968 | 7172753 | - Ruota fonica ABS /ABS ring - Ø 110 x 118 x 101,5 mm | Eurocargo |
| Connessione / Connected:  960036 | | | |
| 930971 | -- | - Ruota fonica magnetica/ Magnetic ABS ring - Ø 110 x 118 x 101,5 mm | Daily 2012 |
| Connessione / Connected:  931082-930999 | | | |

**ARTICOLI VARI PER MOZZI RUOTA
VARIOUS FOR WHEEL HUBS
ARTICLES POUR MOYEURS DE ROUE
ARTIKELN FÜR RADNABEN
КОМПОНЕНТЫ ДЛЯ СТУПИЦ
ARTÍCULOS PARA BUJES DE RUEDA**

EMMERRE
spare parts for trucks and trailers

MAN

| Applicazioni / Applications | Dettagli / Detail | Adattabile a / Adaptable to | Emmerre |
|-----------------------------|---|---|---------------|
| L 2000 TGL TGM | - Ruota fonica ABS /ABS ring - Ø 114 x 160 x 27,5 mm (80 z) | 81524006005 81524030029 81930210397 | 931157 |



| Connessione / Connected: | 960419 |
|--------------------------|--------|
|--------------------------|--------|

| | | | |
|--------|---|-------------|---------------|
| L 2000 | - Ruota fonica ABS /ABS ring - Ø 102/128 x 132/162 x 80 mm (80 z) | 81524030028 | 931158 |
|--------|---|-------------|---------------|









Mozi Ruota
Wheel Hubs

EMMERRE

spare parts for trucks and trailers

MERCEDES

ARTICOLI VARI PER MOZZI RUOTA
VARIOUS FOR WHEEL HUBS
ARTICLES POUR MOYEURS DE ROUE
ARTIKELN FÜR RADNABEN
КОМПОНЕНТЫ ДЛЯ СТУПИЦ
ARTÍCULOS PARA BUJES DE RUEDA

| Emmerre | Adattabile a / Adaptable to | Dettagli / Detail | Applicazioni / Applications |
|--|--|--|--|
| 931130  | 9463340515 | - Ruota fonica ABS /ABS ring - Ø 154 x 179 x 12 mm (100 z) | Axles Mercedes |
| Connessione / Connected:  931832-931827 | | | |
| 931128  | 9453340351 | - Ruota fonica ABS /ABS ring - Ø 165,7 x 178 x 14,5 mm (100 z) | Axor |
| 931124  | 9423560715 9423560315 9423560015 | - Ruota fonica ABS /ABS ring - Ø 176 x 196 x 16 mm (100 z) | Actros Actros MP2 Axor 2 Econic |
| Connessione / Connected:  931833 | | | |
| 931133  | 9423340015 9423340115 | - Ruota fonica ABS /ABS ring - Ø 156 x 187 x 12 mm (100 z) | SK |
| Connessione / Connected:  931829-931825 | | | |



ARTICOLI VARI PER MOZZI RUOTA
 VARIOUS FOR WHEEL HUBS
 ARTICLES POUR MOYEURS DE ROUE
 ARTIKELN FÜR RADNABEN
 КОМПОНЕНТЫ ДЛЯ СТУПИЦ
 ARTÍCULOS PARA BUJES DE RUEDA

EMMERRE
 spare parts for trucks and trailers

MERCEDES

| Applicazioni / Applications | Dettagli / Detail | Adattabile a / Adaptable to | Emmerre |
|--|---|-----------------------------|---------------|
| Actros Actros MP2 Axor Axor 2 | - Ruota fonica ABS /ABS ring - Ø 168 x 202 x 12,5 mm (100 z) | 9463340015 | 931135 |
|  | | | |
| Connessione / Connected:  931840-931825 | | | |
| Atego Atego II | - Ruota fonica ABS /ABS ring - Ø 102/128 x 132/162 x 80 mm (80 z) | 9703560415 9703560315 | 931158 |
|  | | | |
| Atego Atego II/III | - Ruota fonica ABS /ABS ring - Ø 139 x 175 x 18 mm (80 z) | 9763560015 | 931136 |
|  | | | |
| Connessione / Connected:  931811-931814 | | | |
| Axle TE4 TE5/VT TL4/TL5 TZ4/TZ5 | - Calotta mozzo/Wheel hub cover | 9463560020 9463560420 | 931148 |
|  | | | |
| Connessione / Connected:  931827-931832 | | | |

Mozzi Ruota
Wheel Hubs

| Emmerre | Adattabile a / <i>Adaptable to</i> | Dettagli / <i>Detail</i> | Applicazioni / <i>Applications</i> |
|---|------------------------------------|--|------------------------------------|
| 931120 | 7420392016 | - Ruota fonica ABS / <i>ABS ring</i> - Ø 132 x 146 x 12 mm (100 z) | Renault Trucks |
| Connessione / <i>Connected:</i>  931433-931443-931429-931441 | | | |
| 931121 | 7420424109 | - Ruota fonica ABS / <i>ABS ring</i> - Ø 140 x 164 x 7 mm (100 z) | Renault Trucks |
| Connessione / <i>Connected:</i>  931426-931431-931436-931438-931439-931448-931472-931471 | | | |
| 931129 | 7401076760 7421228432 | - Ruota fonica ABS / <i>ABS ring</i> - Ø 166,5 x 184 x 15,8 mm (100 z) | Renault Trucks |
| Connessione / <i>Connected:</i>  931454-931455 | | | |

ARTICOLI VARI PER MOZZI RUOTA
 VARIOUS FOR WHEEL HUBS
 ARTICLES POUR MOYEURS DE ROUE
 ARTIKELN FÜR RADNABEN
 КОМПОНЕНТЫ ДЛЯ СТУПИЦ
 ARTÍCULOS PARA BUJES DE RUEDA

EMMERRE
 spare parts for trucks and trailers

ROR

| Applicazioni / Applications | Dettagli / Detail | Adattabile a / Adaptable to | Emmerre |
|--|---------------------------------|-----------------------------|---------------|
| Axle LM | - Calotta mozzo/Wheel hub cover | 21224673 | 931534 |
|  | | | |
| Connessione / Connected:  931501-931502-931507-931530 | | | |
| Axle TE | - Calotta mozzo/Wheel hub cover | 21220727 | 931535 |
|  | | | |
| Connessione / Connected:  931503 | | | |
| Axle TM | - Calotta mozzo/Wheel hub cover | 21202627 | 931536 |
|  | | | |
| Connessione / Connected:  931500-931504-931505 | | | |
| Axle TA | - Calotta mozzo/Wheel hub cover | 21226038 | 931537 |
|  | | | |
| Connessione / Connected:  931506-931508 | | | |

Mozzi Ruota
Wheel Hubs

| Emmerre | Adattabile a / Adaptable to | Dettagli / Detail | Applicazioni / Applications |
|---|--|--|---|
| 931159   | 4029106100 | - Ruota fonica ABS /ABS ring - Ø 156 x 178 x 12,5 mm (80 z) | Axle |
| Connessione / Connected:  | | | 931597 |
| 931161   | 4029100101 | - Ruota fonica ABS /ABS ring - Ø 156 x 195 x 11,5 mm (100 z) | Axle KRS/RBM/RLBM RSM/SK/SKRS SKRZ/SKRZT WRZM |
| Connessione / Connected:  | | | 931598-931634-931870 |
| 931607   | 3304007200 | - Calotta mozzo/Wheel hub cover | Axle JKRS/JKRZ |
| Connessione / Connected:  | | | 931606 |
| 931624   | 4304010200 3304010202 3304010200 3304010201 | - Calotta mozzo/Wheel hub cover | Axle B9/BL9 S11/7/9 SI 11/9 SIL 11/9 SL 11/9-SZL11 SKRLB Z11/27/28/29/9 ZI 11/9 ZL8/9/11 |
| Connessione / Connected:  | | | 931612-931613-931614-931615 |

ARTICOLI VARI PER MOZZI RUOTA
 VARIOUS FOR WHEEL HUBS
 ARTICLES POUR MOYEURS DE ROUE
 ARTIKELN FÜR RADNABEN
 КОМПОНЕНТЫ ДЛЯ СТУПИЦ
 ARTÍCULOS PARA BUJES DE RUEDA

EMMERRE
 spare parts for trucks and trailers

SAF

| Applicazioni / Applications | Dettagli / Detail | Adattabile a / Adaptable to | Emmerre |
|--|--|-----------------------------|--|
| Axle SKRB | - Calotta mozzo/Wheel hub cover | 4304009300 3304009300 | 931622  |
| Connessione / Connected:  931605 | | | |
| Axle KRS SKRS SKRZ | - Calotta mozzo/Wheel hub cover | 3304008600 | 931623  |
| Connessione / Connected:  931597-931598-931870-931635-931634-931638 | | | |
| Axle SKRS/SKRZ | - Calotta mozzo/Wheel hub cover | 3304007901 | 931625  |
| Connessione / Connected:  931869-931637 | | | |
| Axles Saf | - Ruota fonica ABS /ABS ring - Ø 148 x 157 x 18,5 mm (100 z) | -- | 931600.4  |
| Connessione / Connected:  931600-931612-931613-931631-931632 | | | |

Mozzi Ruota
Wheel Hubs

| Emmerre | Adattabile a / <i>Adaptable to</i> | Dettagli / <i>Detail</i> | Applicazioni / <i>Applications</i> |
|---|---|--|---|
| 931132 | 4029107000 | - Ruota fonica ABS / <i>ABS ring</i> - Ø 150 x 185 x 10,5 mm (90 z) | Axles Saf |
| | | | Connessione / <i>Connected:</i>  931615 |
| 931149 | 4029106300 | - Ruota fonica ABS / <i>ABS ring</i> - Ø 116,5 x 157 x 18,8 mm (90 z) | Axle SKRB 9019 SKRB 9022 |
|  |  | | |
| 931152 | 4029106900 | - Ruota fonica ABS / <i>ABS ring</i> - Ø 148,5 x 184 x 11 mm (90 z) | Axle SKRZ 11037-10 |
|  |  | | |
| | | | Connessione / <i>Connected:</i>  931596-931636 |
| 931180 | 1011008800 | - Dado/ <i>Nut</i> - M 72 x 1,5 - Destro/ <i>Right</i> - Chiave/ <i>Key</i> 85 mm | Axle SKRB |
|  |  | | |

ARTICOLI VARI PER MOZZI RUOTA
 VARIOUS FOR WHEEL HUBS
 ARTICLES POUR MOYEUX DE ROUE
 ARTIKELN FÜR RADNABEN
 КОМПОНЕНТЫ ДЛЯ СТУПИЦ
 ARTÍCULOS PARA BUJES DE RUEDA

EMMERRE
 spare parts for trucks and trailers

SAF

| Applicazioni / Applications | Dettagli / Detail | Adattabile a / Adaptable to | Emmerre |
|---|---|-----------------------------|---------------|
| Axle SKRB | - Dado/Nut - M 72 x 1,5 - Sinistro/Left - Chiave/Key 85 mm | 1011008700 | 931181 |
|  | | | |

Mozzi Ruota
 Wheel Hubs

EMMERRE

spare parts for trucks and trailers

SCANIA



ARTICOLI VARI PER MOZZI RUOTA
VARIOUS FOR WHEEL HUBS
ARTICLES POUR MOYEURS DE ROUE
ARTIKELN FÜR RADNABEN
КОМПОНЕНТЫ ДЛЯ СТУПИЦ
ARTÍCULOS PARA BUJES DE RUEDA

| Emmerre | Adattabile a / Adaptable to | Dettagli / Detail | Applicazioni / Applications |
|---|-----------------------------|--|--|
| 931126 | 1442300 | - Ruota fonica ABS /ABS ring - Ø 126 x 170 x 9,5 mm (100 z) | 164C/G/L Serie 4 - 94C/G-L T 114/124/144 |
|  | | | |
| Connessione / Connected:  931802-931808-931838 | | | |
| 931165 | 1442296 | - Ruota fonica ABS /ABS ring - Ø 172,5 x 188,5 x 20 mm (100 z) | Serie 4 PGRT |
|  | | | |
| Connessione / Connected:  931804-931805 | | | |
| 931164 | 1339680 1375382 | - Ruota fonica ABS /ABS ring - Ø 126 x 164 x 8,5 mm (100 z) | Serie 4 PGRT |
|  | | | |
| 931163 | 1790708 1788291 | - Ruota fonica ABS /ABS ring - Ø 176 x 192 x 13 mm (100 z) | Serie 4 PGRT |
|  | | | |

ARTICOLI VARI PER MOZZI RUOTA
 VARIOUS FOR WHEEL HUBS
 ARTICLES POUR MOYEUX DE ROUE
 ARTIKELN FÜR RADNABEN
 КОМПОНЕНТЫ ДЛЯ СТУПИЦ
 ARTÍCULOS PARA BUJES DE RUEDA



EMMERRE
 spare parts for trucks and trailers









SCANIA

| Applicazioni / Applications | Dettagli / Detail | Adattabile a / Adaptable to | Emmerre |
|---|---------------------------------|---|---------------|
| Serie 4 Serie K Serie PGRT | - Calotta mozzo/Wheel hub cover | 1381114 1480333 1728076 1750065 1762224 | 931626 |
|  | | | |
| Connessione / Connected:  931802 | | | |

Mozzi Ruota
Wheel Hubs

SCHMITZ

| Applicazioni / Applications | Dettagli / Detail | Adattabile a / Adaptable to | Emmerre |
|---|--|-----------------------------|-----------------|
| Axles Schmitz | - Ruota fonica ABS /ABS ring - Ø 148 x 157 x 18,5 mm (100 z) | -- | 931600.4 |
|  | | | |
| Connessione / Connected:  931600 | | | |

| Emmerre | Adattabile a / Adaptable to | Dettagli / Detail | Applicazioni / Applications |
|---|---|--|-----------------------------|
| 931120 | 20392016 | - Ruota fonica ABS /ABS ring - Ø 132 x 146 x 12 mm (100 z) | Volvo trucks |
|  | Connessione / Connected:  931429-931433-931441-931443 | | |
| 931121 | 20424109 | - Ruota fonica ABS /ABS ring - Ø 140 x 164 x 7 mm (100 z) | Volvo trucks |
|  | Connessione / Connected:  931426-931431-931438-931439-931436-931448-931449-931471-931107-931472-931475 | | |
| 931122 | 1075889 | - Ruota fonica ABS /ABS ring - Ø 154 x 158 x 15,8 mm (100 z) | Volvo trucks |
|  | Connessione / Connected:  931427-931432-931440-931442 | | |
| 931129 | 1076760 21228432 | - Ruota fonica ABS /ABS ring - Ø 166,8 x 184 x 15,8 mm (100 z) | Volvo trucks |
|  | Connessione / Connected:  931454-931455 | | |



PASTIGLIE FRENO

BRAKE PADS
JEU DE PLAQUETTES DE FREIN
SATZ BREMSBELAEGE
ТОРМОЗНЫЕ НАКЛАДКИ
JUEGO DE PASTILLAS DE FRENO

NEWS

| Emmerre | Descrizione/Description | Adattabile/Adaptable to | Pagina/Page |
|-----------------|---|-------------------------|-------------|
| 961070E3 | SERIE PASTIGLIE FRENO / SET OF BRAKE PADS | SAF | 448 |
| 961071E3 | SERIE PASTIGLIE FRENO / SET OF BRAKE PADS | SCHMITZ | 450 |

SERIE PASTIGLIE FRENO
BRAKE PADS
JEU DE PLAQUETTES DE FREIN
SATZ BREMSBELAEGE
ТОРМОЗНЫЕ НАКЛАДКИ
JUEGO DE PASTILLAS DE FRENO

EMMERRE
spare parts for trucks and trailers

BPW

| Applicazioni / Applications | Dettagli / Detail | Adattabile a / Adaptable to | | Emmerre |
|---|---|---|--------------------------|-----------------|
| Eco Maxx Eco Plus Trailer SKH SB3745 | <ul style="list-style-type: none"> - Anteriore/Front - Larghezza/Width mm. 211 - Altezza/Height mm. 92,50 - Spessore/Thickness mm. 30 - Con molle/With springs - Con kit accessori/With kit accessories - Con piastre/With plates <p>Omologazione/Homologation Nr.: E3 90R-01110/001 EST02</p> | WVA 29095 WVA 29093 WVA 29145 WVA 29184 WVA 29197 WVA 29094 WVA 29096 0980102930 0980106210 0203121500 | 0203121600 0980102750 | 960948E3 |



| Connessione / Connected: | | 960352-960358-960359-960360-960361 | | 960523 |
|--------------------------|--|------------------------------------|--|--------|
|--------------------------|--|------------------------------------|--|--------|

| | | | | |
|---|---|--|--|-----------------|
| Eco Plus Eco Maxx Trailer SB3745T SKH SKHBF SKHBM SKHSF SKHSM SKHSZ | <ul style="list-style-type: none"> - Larghezza/Width mm. 210,90 - Altezza/Height mm. 92,50 - Spessore/Thickness mm. 30 - Con molle/With springs - Con kit accessori/With kit accessories - Con piastre/With plates <p>Omologazione/Homologation Nr.: E3 90R-01130/001 EST02</p> | WVA 29165/WVA29306 WVA 29215 WVA 29268 0980107240 0980107090 0980106350 0980108150 0509290100 | | 960994E3 |
|---|---|--|--|-----------------|



| Connessione / Connected: | | 960570-960572-960575 | | 960523-960529 |
|--------------------------|--|----------------------|--|---------------|
|--------------------------|--|----------------------|--|---------------|

| | | | | |
|---------|--|---|--|-------------------------------------|
| SB 3308 | <ul style="list-style-type: none"> - Larghezza/Width mm. 173,60 - Altezza/Height mm. 84 - Spessore/Thickness mm. 27/34 <p>Omologazione/Homologation Nr.: E3 90R-01132/001 EST01 E11 90R-02A01080/42091</p> | WVA 29115 WVA 29116 WVA 29148 0980107070 | | 960998E3 960998E11 |
|---------|--|---|--|-------------------------------------|



| Emmerre | Adattabile a / Adaptable to | Dettagli / Detail | Applicazioni / Applications |
|---|---|---|---------------------------------|
| 960996E1 960996E3 960996E11  | WVA 29171 WVA 29271 0980108160 0980106440 0980106950 0980107260 0509290080 | <ul style="list-style-type: none"> - Larghezza/Width mm. 210,90 - Altezza/Height mm. 108 - Spessore/Thickness mm. 30 - Con molle/With springs - Con kit accessori/With kit accessories - Con piastre/With plates <p>Omologazione/Homologation Nr.: E1 90R-011363/011 E3 90R-01134/001 EST02 E11 90R-02A01080/42091</p> | Trailer SB 4345T SB 4309T |
| Connessione / Connected:  960571  960523 | | | |
| 960997E3  | WVA 29167 WVA 29270 0980106450 0509290070 0509290090 0980107280 0980107250 | <ul style="list-style-type: none"> - Larghezza/Width mm. 247,20 - Altezza/Height mm. 109,70 - Spessore/Thickness mm. 30 - Con molle/With springs - Con kit accessori/With kit accessories - Con piastre/With plates <p>Omologazione/Homologation Nr.: E3 90R-01133/001 EST02</p> | Trailer SB 4345T SB 4309T |
| Connessione / Connected:  960571  960523 | | | |
| 960944E1 960944E3  | 0980102920 0980106200 0980106360 WVA 29253 WVA 29087 WVA 29105 0980106960 0536270020 0980102570 | <ul style="list-style-type: none"> - Anteriore e posteriore/Front and Rear - Larghezza/Width mm. 247,20 - Altezza/Height mm. 109,70 - Spessore/Thickness mm. 30 - Con molle/With springs - Con kit accessori/With kit accessories - Con piastre/With plates <p>Omologazione/Homologation Nr.: E1 90R-011363/008 E3 90R-01101/001 EST03</p> | Trailer SH - SB4345 |
| Connessione / Connected:  960356-960574  960523 | | | |

**SERIE PASTIGLIE FRENO
BRAKE PADS
JEU DE PLAQUETTES DE FREIN
SATZ BREMSBELAEGE
ТОРМОЗНЫЕ НАКЛАДКИ
JUEGO DE PASTILLAS DE FRENO**

EMMERRE
spare parts for trucks and trailers

BPW

| Applicazioni / Applications | Dettagli / Detail | Adattabile a / Adaptable to | Emmerre |
|--|---|---|---------------|
| TSB3709 | <ul style="list-style-type: none"> - Larghezza/Width mm. 210,6/213 - Altezza/Height mm. 92,50/94 - Spessore/Thickness mm. 29,60 - Con molle/With springs - Con kit accessori/With kit accessories - Con piastre/With plates | WVA 29227 0980107940 0900061790 0980107550 0980107561 0980107951 | 970024 |
| TSB4309 | <ul style="list-style-type: none"> - Larghezza/Width mm. 210,6/213 - Altezza/Height mm. 105/106,50 - Spessore/Thickness mm. 29,60 - Con molle/With springs - Con kit accessori/With kit accessories - Con piastre/With plates | WVA 29228 0980107960 0980107570 0980107971 0509290130 0900061792 0980107581 | 970025 |
| Connesione / Connected:  960573 | | | |
| TSB4312 | <ul style="list-style-type: none"> - Larghezza/Width mm. 246,7/249 - Altezza/Height mm. 105/106,50 - Spessore/Thickness mm. 29,60 - Con molle/With springs - Con kit accessori/With kit accessories - Con piastre/With plates | WVA 29267 WVA 29127 0980107980 0980107590 0900061793 | 970026 |

**PATENT
PENDING**



**PATENT
PENDING**







**PATENT
PENDING**



EMMERRE
 spare parts for trucks and trailers

MERCEDES
AXLE - CARDI







SERIE PASTIGLIE FRENO
BRAKE PADS
JEU DE PLAQUETTES DE FREIN
SATZ BREMSBELAEGE
ТОРМОЗНЫЕ НАКЛАДКИ
JUEGO DE PASTILLAS DE FRENO

| Emmerre | Adattabile a / Adaptable to | Dettagli / Detail | Applicazioni / Applications | |
|--|---|-------------------------------------|--|---------------|
| 960948E3 | WVA 29095 WVA 29093 WVA 29094 WVA 29096 81508206022 | WVA 29145 WVA 29184 WVA 29197 | - Larghezza/Width mm. 211 - Altezza/Height mm. 92,50 - Spessore/Thickness mm. 30 - Con molle/With springs - Con kit accessori/With kit accessories - Con piastre/With plates | Mercedes Axle |
|  | | | | |
| Omologazione/Homologation Nr.: E3 90R-01110/001 EST02 | | | | |
| | | | Connessione / Connected:  960600 | |
| 960944E1 960944E3 | WVA 29253 WVA 29087 WVA 29105 0034201620 0024204920 0044206020 | WVA 29253 WVA 29087 WVA 29105 | - Larghezza/Width mm. 247,20 - Altezza/Height mm. 109,70 - Spessore/Thickness mm. 30 - Con molle/With springs - Con kit accessori/With kit accessories - Con piastre/With plates | Mercedes Axle |
|  | | | | |
| Omologazione/Homologation Nr.: E1 90R-011363/008 E3 90R-01101/001 EST03 | | | | |
| | | | Connessione / Connected:  960354  960523 | |

SERIE PASTIGLIE FRENO
BRAKE PADS
JEU DE PLAQUETTES DE FREIN
SATZ BREMSBELAEGE
ТОРМОЗНЫЕ НАКЛАДКИ
JUEGO DE PASTILLAS DE FRENO

EMMERRE
spare parts for trucks and trailers

DAF







| Applicazioni / Applications | Dettagli / Detail | Adattabile a / Adaptable to | Emmerre |
|--|---|---|-----------------|
| FA 45 FA 500 FA 600 FA 700 FA 800 FA 900 FA 1000 FA 1100 | - Anteriore/Front - Larghezza/Width mm. 191 - Altezza/Height mm. 87 - Spessore/Thickness mm. 23 | WVA 29024 WVA 29017 WVA 29027 BBU8177 BBU8178 | 960904 |
|  | | | |
| Connessione / Connected:  960303-960304 | | | |
| FA 55 | - Anteriore/Front - Larghezza/Width mm. 204,50 - Altezza/Height mm. 106 - Spessore/Thickness mm. 27 | WVA 29077 WVA 29092 AMPA694 AMPB016 | 960943 |
|  | | | |
| Connessione / Connected:  960389 | | | |
| LF 45 | - Anteriore e posteriore/Front and Rear - Larghezza/Width mm. 175,50 - Altezza/Height mm. 85,60 - Spessore/Thickness mm. 26 | WVA 29088 WVA 29091 1436901 | 960969E3 |
|  | | | |
| Connessione / Connected:  960368-960369-960375  960801 | | | |

| Emmerre | Adattabile a / Adaptable to | Dettagli / Detail | Applicazioni / Applications |
|---|--|--|--|
| 960272E3 | WVA 29142 WVA 29141 WVA 29119 1440504 | <p>- Anteriore e posteriore/ Front and Rear</p> <ul style="list-style-type: none"> - Larghezza/Width mm. 204,60 - Altezza/Height mm. 99,60 - Spessore/Thickness mm. 30 <p>Omologazione/Homologation Nr.: E3 90R-01139/001</p> | LF 55 |
|  | | | |
| | | Connessione / Connected:  960376-960377  960551 | |
| 960999E3 | WVA 29126 WVA 29159 1628064 | <p>- Anteriore/Front</p> <ul style="list-style-type: none"> - Larghezza/Width mm. 210,60 - Altezza/Height mm. 92,30 - Spessore/Thickness mm. 29,80 - Con molle/With springs - Con kit accessori/With kit accessories <p>Omologazione/Homologation Nr.: E3 90R-01131/001</p> | LF 45 LF 55 |
|  | | | |
| | | Connessione / Connected:  960377 | |
| 960944E1 960944E3 | WVA 29253 WVA 29087 WVA 29105 1617343 1439324 1797053 | <p>- Anteriore e posteriore/ Front and Rear</p> <ul style="list-style-type: none"> - Larghezza/Width mm. 247,20 - Altezza/Height mm. 109,70 - Spessore/Thickness mm. 30 - Con molle/With springs - Con kit accessori/With kit accessories - Con piastre/With plates <p>Omologazione/Homologation Nr.: E1 90R-011363/008 E3 90R-01101/001 EST03</p> | CF 65 CF 85 LF 55 XF 95 XF 105 |
|  | | | |
| | | Connessione / Connected:  960213  960523 | |

**SERIE PASTIGLIE FRENO
BRAKE PADS
JEU DE PLAQUETTES DE FREIN
SATZ BREMSBELAEGE
ТОРМОЗНЫЕ НАКЛАДКИ
JUEGO DE PASTILLAS DE FRENO**

EMMERRE
spare parts for trucks and trailers

DAF

| Applicazioni / Applications | Dettagli / Detail | Adattabile a / Adaptable to | Emmerre |
|--|---|-----------------------------|-----------------|
| CF 65 CF 75 CF 85 XF 95 XF 105 | <ul style="list-style-type: none"> - Anteriore e posteriore/<i>Front and Rear</i> - Larghezza/<i>Width</i> mm. 248 - Altezza/<i>Height</i> mm. 109,50 - Spessore/<i>Thickness</i> mm. 30 - Con molle/<i>With springs</i> - Con kit accessori/<i>With kit accessories</i> - Con piastre/<i>With plates</i> Knorr system SB/SN7 - Protec 5 - Nostro Brevetto/<i>Our Patent</i> <p>Omologazione/Homologation Nr.: E3 90R-02A0794/4091</p> | WVA 29252 1878030 | 960794E3 |
|  | | | |
|   | | | |
| Connessione / Connected:  960213 | | | |
| LF 45 | <ul style="list-style-type: none"> - Anteriore e posteriore/<i>Front and Rear</i> - Larghezza/<i>Width</i> mm. 175,50 - Altezza/<i>Height</i> mm. 85,60 - Spessore/<i>Thickness</i> mm. 26 - Con indicatori di usura e kit fissaggio/ <i>With wear indicators and fixed kit</i> <p>Omologazione/Homologation Nr.: E3 90R-01116/001 EST02</p> | WVA 29088 1436901 | 961041 |
|  | | | |
| Connessione / Connected:  960368-960369-960375  960801 | | | |

EMMERRE

spare parts for trucks and trailers

FIAT

SERIE PASTIGLIE FRENO BRAKE PADS JEU DE PLAQUETTES DE FREIN SATZ BREMSBELAEGE ТОРМОЗНЫЕ НАКЛАДКИ JUEGO DE PASTILLAS DE FRENO

| Emmerre | Adattabile a / Adaptable to | Dettagli / Detail | Applicazioni / Applications | |
|--|--|---|--|--------|
| 960862 | WVA 20741 WVA 20787 9945070 9941207 9940092 9939028 | - Anteriore/Front - Larghezza/Width mm. 130 - Altezza/Height mm. 71,50 - Spessore/Thickness mm. 19 - Connettore tondo/Round Connector | Ducato | |
| Connessione / Connected:  960378-960379 | | | | |
| 960867 | WVA 21205 WVA 21206 9945076 | - Anteriore/Front - Larghezza/Width mm. 145 - Altezza/Height mm. 71,50 - Spessore/Thickness mm. 19,40 - Connettore tondo/Round Connector | Ducato | |
| Connessione / Connected:  960378-960379 | | | | |
| 960929 | WVA 21797 WVA 23602 71752980 77362235 77362212 | 9945788 9948626 | - Anteriore/Front - Larghezza/Width mm. 145 - Altezza/Height mm. 61 - Spessore/Thickness mm. 19,70 - Connettore quadrato/Square Connector | Ducato |
| Connessione / Connected:  960201-960202-960380-960381 | | | | |



SERIE PASTIGLIE FRENO
BRAKE PADS
JEU DE PLAQUETTES DE FREIN
SATZ BREMSBELAEGE
ТОРМОЗНЫЕ НАКЛАДКИ
JUEGO DE PASTILLAS DE FRENO

EMMERRE
spare parts for trucks and trailers

FIAT

| Applicazioni / Applications | Dettagli / Detail | Adattabile a / Adaptable to | Emmerre |
|--|---|--|-----------------|
| Ducato | <ul style="list-style-type: none"> - Anteriore/Front - Larghezza/Width mm. 160 - Altezza/Height mm. 64 - Spessore/Thickness mm. 19,70 - Connettore tondo/Round Connector | WVA 21799 WVA 21800 71752993 77362209 9945810 | 960935 |
|  | | | |
| Connessione / Connected:  960201-960202-960380-960381 | | | |
| Ducato 2006 | <ul style="list-style-type: none"> - Anteriore/Front - Larghezza/Width mm. 169 - Altezza/Height mm. 61,60 - Spessore/Thickness mm. 19 - Connettore quadrato/Square Connector <p>Omologazione/Homologation Nr.: E3 90R-01114/001</p> | WVA 24468 WVA 24469 77366017 77364014 77364160 | 960181E3 |
|  | | | |
| Connessione / Connected:  960202-960183 | | | |
| Ducato 2006 | <ul style="list-style-type: none"> - Anteriore/Front - Larghezza/Width mm. 169 - Altezza/Height mm. 69,30 - Spessore/Thickness mm. 19 - Connettore quadrato/Square Connector <p>Omologazione/Homologation Nr.: E3 90R-01143/001</p> | WVA 24466 WVA 24467 77366021 77364318 77364015 | 960182E3 |
|  | | | |
| Connessione / Connected:  960202 | | | |

EMMERRE

spare parts for trucks and trailers

FIAT

SERIE PASTIGLIE FRENO BRAKE PADS JEU DE PLAQUETTES DE FREIN SATZ BREMSBELÄGE ТОРМОЗНЫЕ НАКЛАДКИ JUEGO DE PASTILLAS DE FRENO

| Emmerre | Adattabile a / Adaptable to | Dettagli / Detail | Applicazioni / Applications |
|---|---|---|-----------------------------|
| 960428 | WVA 23919 WVA 23858 77362216 9949517 71752978 71770070 | - Anteriore/Front - Larghezza/Width mm. 164,80 - Altezza/Height mm. 69,30 - Spessore/Thickness mm. 19 | Ducato 2006 |
|  | | Connessione / Connected:  960202-960183-960185 | |
| 960186E3 | WVA 24467 WVA 24466 77366023 77364319 77364161 | - Anteriore/Front - Larghezza/Width mm. 169 - Altezza/Height mm. 69 - Spessore/Thickness mm. 19 - Connettore quadrato/Square Connector | Ducato 2006 |
|  | | Omologazione/Homologation Nr.: E3 90R-01143/001 | |
| | | Connessione / Connected:  960185 | |
| 960190 | WVA 24589 WVA 23921 77364860 77362274 9949407 | - Posteriore/Rear - Larghezza/Width mm. 109,60 - Altezza/Height mm. 50 - Spessore/Thickness mm. 20 | Ducato 2008 JTD |
|  | | Connessione / Connected:  960188-960189 | |

SERIE PASTIGLIE FRENO
BRAKE PADS
JEU DE PLAQUETTES DE FREIN
SATZ BREMSBELAEGE
ТОРМОЗНЫЕ НАКЛАДКИ
JUEGO DE PASTILLAS DE FRENO

EMMERRE
spare parts for trucks and trailers

FIAT

| Applicazioni / Applications | Dettagli / Detail | Adattabile a / Adaptable to | Emmerre |
|---|--|---|---------------|
| Ducato | <ul style="list-style-type: none"> - Posteriore/Rear - Larghezza/Width mm. 136,90 - Altezza/Height mm. 48,80 - Spessore/Thickness mm. 18,80 | WVA 24465 77364016 | 960173 |
|  | | | |
| Connessione / Connected:  960174-960176-960178 | | | |
| Ducato | <ul style="list-style-type: none"> - Anteriore/Front - Larghezza/Width mm. 140,50 - Altezza/Height mm. 65,60 - Spessore/Thickness mm. 19,10 | WVA 23917 WVA 23918 77364862 77362219 9949516 71752979 | 960171 |
|  | | | |
| Connessione / Connected:  960380 | | | |

Pastiglie Freno
Brake Pads

| Emmerre | Adattabile a / Adaptable to | Dettagli / Detail | Applicazioni / Applications |
|--|---|--|-----------------------------|
| 960868 | WVA 21470 6965579 7018202 6197738 5028763 | - Anteriore/Front - Larghezza/Width mm. 139 - Altezza/Height mm. 65 - Spessore/Thickness mm. 19 | Transit |
| Connessione / Connected:  960382-960383 | | | |
| 960869 | WVA 21469 6197739 6965580 7018203 5028764 | - Anteriore/Front - Larghezza/Width mm. 139 - Altezza/Height mm. 72 - Spessore/Thickness mm. 19 | Transit |
| Connessione / Connected:  960382-960383 | | | |
| 960870E3 | WVA 23840 1144288 WVA 23841 4095132 WVA 23435 4114749 WVA 23434 1318147 1465168 | - Anteriore/Front - Larghezza/Width mm. 168,90 - Altezza/Height mm. 65 - Spessore/Thickness mm. 18,40 Omologazione/Homologation Nr.: <u>E3 90R-01122/001</u> | Transit |
| Connessione / Connected:  960384 | | | |



SERIE PASTIGLIE FRENO
BRAKE PADS
JEU DE PLAQUETTES DE FREIN
SATZ BREMSBELAEGE
ТОРМОЗНЫЕ НАКЛАДКИ
JUEGO DE PASTILLAS DE FRENO

EMMERRE
spare parts for trucks and trailers

FORD

| Applicazioni / Applications | Dettagli / Detail | Adattabile a / Adaptable to | Emmerre |
|---|--|--|-----------------|
| Transit | <ul style="list-style-type: none"> - Anteriore/Front - Larghezza/Width mm. 168,90 - Altezza/Height mm. 65 - Spessore/Thickness mm. 18,40 <p>Omologazione/Homologation Nr.: E3 90R-01122/002</p> | WVA 23577 4077636 WVA 23578 1479223 WVA 23579 1465166 WVA 23580 1135167 WVA 23430 4053306 | 960871E3 |
|  | | | |
| Connessione / Connected:  960385 | | | |
| Transit Transit Autobus | <ul style="list-style-type: none"> - Posteriore/Rear - Larghezza/Width mm. 109,60 - Altezza/Height mm. 63,80 - Spessore/Thickness mm. 20 <p>Omologazione/Homologation Nr.: E3 90R-01115/001</p> | WVA 29123 1501265 1718023 8C1V2M008AB | 960911E3 |
|  | | | |
| Transit Tourneo Connect | <ul style="list-style-type: none"> - Anteriore/Front - Larghezza/Width mm. 156,30 - Altezza/Height mm. 67,30/62,50 - Spessore/Thickness mm. 18,10/17,60 <p>Omologazione/Homologation Nr.: E11 90R-02A0904/17121</p> | WVA 23440 WVA 23441 4427737 | 960784 |
|  | | | |

| Emmerre | Adattabile a / Adaptable to | Dettagli / Detail | Applicazioni / Applications |
|---------------|--------------------------------|---|-----------------------------|
| 960764 | WVA25602 1763915 1842632 | - Anteriore/Front - Larghezza/Width mm. 174,7 - Altezza/Height mm. 68,7 - Spessore/Thickness mm. 17 | Transit Tourneo |



| | | | |
|---------------|---------------------------------|--|--------------------|
| 960765 | WVA25603 WVA25604 1840037 | - Posteriore/Rear - Larghezza/Width mm. 137,1 - Altezza/Height mm. 58,5/60,8 - Spessore/Thickness mm. 17,8 | Transit Tourneo |
|---------------|---------------------------------|--|--------------------|



GASOLONE

| Emmerre | Adattabile a / Adaptable to | Dettagli / Detail | Applicazioni / Applications |
|-----------------|-----------------------------|--|-----------------------------|
| 960244E3 | WVA 21048.A RI410920100 | - Anteriore/Front - Larghezza/Width mm. 110 - Altezza/Height mm. 73 - Spessore/Thickness mm. 18,30 Omologazione/Homologation Nr.: E3 90R-01104/002 | |











Connessione / Connected:  960243-960256

SERIE PASTIGLIE FRENO
BRAKE PADS
JEU DE PLAQUETTES DE FREIN
SATZ BREMSBELAEGE
ТОРМОЗНЫЕ НАКЛАДКИ
JUEGO DE PASTILLAS DE FRENO

EMMERRE
spare parts for trucks and trailers

ISUZU

| Applicazioni / Applications | Dettagli / Detail | Adattabile a / Adaptable to | Emmerre |
|--|--|--|---------------|
| NKR 3.0D NPR | - Anteriore/Front - Larghezza/Width mm. 206,10 - Altezza/Height mm. 74,80 - Spessore/Thickness mm. 20,50 | 8973292660 8971686330 8973775220 | 960410 |
|  | | | |
| Connessione / Connected:  960518-960519 | | | |
| NPR 4.8D NQR | - Anteriore/Front - Larghezza/Width mm. 206,10 - Altezza/Height mm. 80,10 - Spessore/Thickness mm. 20,50 | 8971686340 97168634 | 960411 |
|  | | | |
| Connessione / Connected:  960520-960521 | | | |
| NPR 4.8D NQR | - Anteriore/Front - Larghezza/Width mm. 183,20-238,20 - Altezza/Height mm. 69,80-93,40 - Spessore/Thickness mm. 22,50-23 | 8970947100 | 960412 |
|  | | | |
| Connessione / Connected:  960520 | | | |

| Emmerre | Adattabile a / <i>Adaptable to</i> | Dettagli / <i>Detail</i> | Applicazioni / <i>Applications</i> |
|--|------------------------------------|---|---|
| <p>960408</p>  | <p>8980912710</p> | <p>- Posteriore/Rear - Larghezza/<i>Width</i> mm. 178 - Altezza/<i>Height</i> mm. 67,90 - Spessore/<i>Thickness</i> mm. 20,50</p> | <p>Series N</p> |
| | | | <p>Connessione / <i>Connected:</i>  960545</p> |

SERIE PASTIGLIE FRENO
BRAKE PADS
JEU DE PLAQUETTES DE FREIN
SATZ BREMSBELAEGE
ТОРМОЗНЫЕ НАКЛАДКИ
JUEGO DE PASTILLAS DE FRENO

EMMERRE
spare parts for trucks and trailers

IVECO

| Applicazioni / Applications | Dettagli / Detail | Adattabile a / Adaptable to | Emmerre |
|--|---|-----------------------------------|-----------------|
| Daily Restyling New Daily Turbodaily | <ul style="list-style-type: none"> - Anteriore/Front - Larghezza/Width mm. 110 - Altezza/Height mm. 73 - Spessore/Thickness mm. 18,30 - Connettore tondo/Round Connector <p>Omologazione/Homologation Nr.: E3 90R-01117/001</p> | WVA 29037 WVA 29038 1906158 | 960913E3 |



| | |
|-------------------------|--|
| Connesione / Connected: |  960021 |
|-------------------------|--|

| | | | |
|--|--|--|---------------|
| Daily Restyling New Daily Turbodaily | <ul style="list-style-type: none"> - Anteriore/Front - Larghezza/Width mm. 110 - Altezza/Height mm. 73 - Spessore/Thickness mm. 18,30 - Connettore quadrato/Square Connector | WVA 29139 WVA 29037 1906428 1906429 | 960995 |
|--|--|--|---------------|



| | |
|-------------------------|--|
| Connesione / Connected: |  960021 |
|-------------------------|--|

| | | | |
|--|---|-----------------------------------|-----------------|
| Daily Restyling New Daily Turbodaily | <ul style="list-style-type: none"> - Anteriore/Front - Larghezza/Width mm. 110 - Altezza/Height mm. 73 - Spessore/Thickness mm. 18,30 - Connettore tondo/Round Connector <p>Omologazione/Homologation Nr.: E3 90R-01104/001</p> | WVA 21048 WVA 29041 1906159 | 960894E3 |
|--|---|-----------------------------------|-----------------|



| | |
|-------------------------|--|
| Connesione / Connected: |  960022 |
|-------------------------|--|

I riferimenti indicati non sono originali ma perfettamente intercambiabili. I codici originali e le case costruttrici sono indicati a puro titolo informativo
The details described are not original but perfectly interchangeable. The original references and manufacturer names are given for information purposes only.

EMMERRE

spare parts for trucks and trailers

IVECO

SERIE PASTIGLIE FRENO BRAKE PADS JEU DE PLAQUETTES DE FREIN SATZ BREMSBELAEGE ТОРМОЗНЫЕ НАКЛАДКИ JUEGO DE PASTILLAS DE FRENO







| Emmerre | Adattabile a / Adaptable to | Dettagli / Detail | Applicazioni / Applications |
|---|-----------------------------------|---|--|
| 960898 | WVA 21160 WVA 20359 1906157 | - Anteriore/Front - Larghezza/Width mm. 105 - Altezza/Height mm. 75 - Spessore/Thickness mm. 18 - Connettore tondo/Round Connector | Daily Restyling New Daily Turbodaily |
| Connessione / Connected:  960022 | | | |
| 960893E3 | WVA 21048 WVA 21188 1906206 | - Anteriore/Front - Larghezza/Width mm. 110 - Altezza/Height mm. 73 - Spessore/Thickness mm. 18,30 - Connettore tondo e ovale/ Round and Oval Connector | Daily Restyling New Daily Turbodaily |
| Connessione / Connected:  960022 | | | |
| 960892 | WVA 20359 WVA 20653 1906207 | - Anteriore/Front - Larghezza/Width mm. 105 - Altezza/Height mm. 75 - Spessore/Thickness mm. 18 - Connettore tondo e ovale/ Round and Oval Connector | Daily Restyling New Daily Turbodaily |
| Connessione / Connected:  960022 | | | |



SERIE PASTIGLIE FRENO
BRAKE PADS
JEU DE PLAQUETTES DE FREIN
SATZ BREMSBELAEGE
ТОРМОЗНЫЕ НАКЛАДКИ
JUEGO DE PASTILLAS DE FRENO

EMMERRE
spare parts for trucks and trailers

IVECO

| Applicazioni / Applications | Dettagli / Detail | Adattabile a / Adaptable to | Emmerre |
|--|--|-----------------------------------|-----------------|
| Daily Restyling New Daily Turbodaily | <ul style="list-style-type: none"> - Anteriore/Front - Larghezza/Width mm. 149 - Altezza/Height mm. 69 - Spessore/Thickness mm. 18 - Connettore tondo/Round Connector <p>Omologazione/Homologation Nr.: E3 90R-01121/001</p> | WVA 20465 WVA 29012 1906040 | 960900E3 |
| Connessione / Connected:  960023  960876 | | | |
| Daily Restyling New Daily Turbodaily | <ul style="list-style-type: none"> - Anteriore/Front - Larghezza/Width mm. 149 - Altezza/Height mm. 69 - Spessore/Thickness mm. 18 - Connettore tondo/Round Connector <p>Omologazione/Homologation Nr.: E3 90R-01121/001</p> | WVA 20465 WVA 29040 1906243 | 960941E3 |
| Connessione / Connected:  960023  960876 | | | |
| Turbodaily | <ul style="list-style-type: none"> - Anteriore/Front - Larghezza/Width mm. 174 - Altezza/Height mm. 69 - Spessore/Thickness mm. 20 - Connettore ovale/Oval Connector | WVA 29001 WVA 29107 1906427 | 960974 |
| Connessione / Connected:  960039  960876 | | | |



EMMERRE

spare parts for trucks and trailers

IVECO

SERIE PASTIGLIE FRENO BRAKE PADS JEU DE PLAQUETTES DE FREIN SATZ BREMSBELAEGE ТОРМОЗНЫЕ НАКЛАДКИ JUEGO DE PASTILLAS DE FRENO

| Emmerre | Adattabile a / Adaptable to | Dettagli / Detail | Applicazioni / Applications |
|---|---|--|--|
| 960940 | WVA 29001 WVA 29003 1906183 | - Anteriore/Front - Larghezza/Width mm. 174,70 - Altezza/Height mm. 69 - Spessore/Thickness mm. 20 - Connettore tondo/Round Connector | Turbodaily |
|  | | | Connesione / Connected:  960039  960876 |
| 960910E3 | WVA 29121 2996605 42470835 | - Anteriore/Front - Larghezza/Width mm. 164,80 - Altezza/Height mm. 66,50 - Spessore/Thickness mm. 17 | Daily City 2000 |
|  | | Omologazione/Homologation Nr.: E3 90R-01103/001 EST02 | Connesione / Connected:  960923  960864-960879 |
| 960911E3 | WVA 29123 42561101 42555406 42470841 | - Posteriore/Rear - Larghezza/Width mm. 109,60 - Altezza/Height mm. 63,80 - Spessore/Thickness mm. 20 | Daily City 2000 |
|  | | Omologazione/Homologation Nr.: E3 90R-01115/001 | Connesione / Connected:  960924-960925  960863-960979 |

SERIE PASTIGLIE FRENO
BRAKE PADS
JEU DE PLAQUETTES DE FREIN
SATZ BREMSBELAEGE
ТОРМОЗНЫЕ НАКЛАДКИ
JUEGO DE PASTILLAS DE FRENO

EMMERRE
spare parts for trucks and trailers

IVECO

| Applicazioni / Applications | Dettagli / Detail | Adattabile a / Adaptable to | Emmerre |
|--|--|-----------------------------|-----------------|
| Daily Restyling New Daily Turbodaily | <ul style="list-style-type: none"> - Anteriore e posteriore/<i>Front and Rear</i> - Larghezza/<i>Width</i> mm. 164,80 - Altezza/<i>Height</i> mm. 66,50 - Spessore/<i>Thickness</i> mm. 20,30 <p>Omologazione/Homologation Nr.: E3 90R-01103/001 EST02</p> | WVA 29121 1906401 | 960909E3 |
|  | | | |
| Connessione / Connected:  960050-960051  960864-960879 | | | |
| Daily Restyling New Daily Turbodaily | <ul style="list-style-type: none"> - Anteriore e posteriore/<i>Front and Rear</i> - Larghezza/<i>Width</i> mm. 164,80 - Altezza/<i>Height</i> mm. 66,50 - Spessore/<i>Thickness</i> mm. 20 <p>Omologazione/Homologation Nr.: E3 90R-01103/001 EST02</p> | WVA 29121 2992339 | 960992E3 |
|  | | | |
| Connessione / Connected:  960050-960051  960864-960879 | | | |
| Daily City 2000 | <ul style="list-style-type: none"> - Anteriore e posteriore/<i>Front and Rear</i> - Larghezza/<i>Width</i> mm. 164,50 - Altezza/<i>Height</i> mm. 67,80 - Spessore/<i>Thickness</i> mm. 20 <p>Omologazione/Homologation Nr.: E3 90R-01102/001</p> | WVA 29160 2995632 | 960502E3 |
|  | | | |
| Connessione / Connected:  960501  960863 | | | |

EMMERRE

spare parts for trucks and trailers

IVECO

SERIE PASTIGLIE FRENO BRAKE PADS JEU DE PLAQUETTES DE FREIN SATZ BREMSBELAEGE ТОРМОЗНЫЕ НАКЛАДКИ JUEGO DE PASTILLAS DE FRENO

| Emmerre | Adattabile a / Adaptable to | Dettagli / Detail | Applicazioni / Applications |
|-----------------|------------------------------------|---|-----------------------------|
| 960503E3 | WVA 29121 2996535 2995633 | - Anteriore e posteriore/ Front and Rear - Larghezza/Width mm. 164,80 - Altezza/Height mm. 66,50 - Spessore/Thickness mm. 20,30 Omologazione/Homologation Nr.: E3 90R-01103/001 EST02 | Daily City 2000 |
| | |  | |
| | | Connessione / Connected:  960501 | |
| 960504E3 | WVA 29121 2995693 | - Anteriore e posteriore/ Front and Rear - Larghezza/Width mm. 164,80 - Altezza/Height mm. 66,50 - Spessore/Thickness mm. 20,30 Omologazione/Homologation Nr.: E3 90R-01103/001 EST02 | Daily City 2000 |
| | |  | |
| | | Connessione / Connected:  960501 | |
| 960973E3 | WVA 29160 WVA 29161 42536101 | - Anteriore/Front - Larghezza/Width mm. 164,50 - Altezza/Height mm. 67,80 - Spessore/Thickness mm. 20 Omologazione/Homologation Nr.: E3 90R-01102/001 | Daily City 2000 |
| | |  | |
| | | Connessione / Connected:  960107  960864-960879 | |

SERIE PASTIGLIE FRENO
BRAKE PADS
JEU DE PLAQUETTES DE FREIN
SATZ BREMSBELAEGE
ТОРМОЗНЫЕ НАКЛАДКИ
JUEGO DE PASTILLAS DE FRENO

EMMERRE
spare parts for trucks and trailers

IVECO

| Applicazioni / Applications | Dettagli / Detail | Adattabile a / Adaptable to | Emmerre |
|---|---|-----------------------------------|-------------------------------------|
| Daily City 2000 | <ul style="list-style-type: none"> - Posteriore/Rear - Larghezza/Width mm. 164,80 - Altezza/Height mm. 66,50 - Spessore/Thickness mm. 20,30 <p>Omologazione/Homologation Nr.: E3 90R-01103/001 EST02</p> | WVA 29121 42535791 | 960899E3 |
|  | | | |
| Connessione / Connected:  960108  960864-960879 | | | |
| Daily 2006 M.Y. | <ul style="list-style-type: none"> - Anteriore/Front - Larghezza/Width mm. 163,10 - Altezza/Height mm. 67,20 - Spessore/Thickness mm. 20,80 <p>Omologazione/Homologation Nr.: E3 90R-01108/001 E11 90R-02A01080/43823</p> | WVA 29229 42561355 42555881 | 960513E3 960513E11 |
|  | | | |
| Connessione / Connected:  960512-960696  960514 | | | |
| Daily 2006 M.Y. | <ul style="list-style-type: none"> - Posteriore/Rear - Larghezza/Width mm. 141,10 - Altezza/Height mm. 72,75 - Spessore/Thickness mm. 21 <p>Omologazione/Homologation Nr.: E3 90R-01106/001 E11 90R-02A01080/43824</p> | WVA 29232 42555917 | 960516E3 960516E11 |
|  | | | |
| Connessione / Connected:  960498-960515-960694-960695  960517 | | | |

EMMERRE

spare parts for trucks and trailers

IVECO

SERIE PASTIGLIE FRENO BRAKE PADS JEU DE PLAQUETTES DE FREIN SATZ BREMSBELAEGE ТОРМОЗНЫЕ НАКЛАДКИ JUEGO DE PASTILLAS DE FRENO

| Emmerre | Adattabile a / Adaptable to | Dettagli / Detail | Applicazioni / Applications |
|--|-----------------------------|---|----------------------------------|
| 961015 | WVA 29122 42555669 | - Anteriore/Front - Larghezza/Width mm. 174,60 - Altezza/Height mm. 85,40 - Spessore/Thickness mm. 22 Omologazione/Homologation Nr.: E3 90R-01105/002 EST01 | Daily 65-70 MY 2006/2009/2012 |
|  | | | |
| Connessione / Connected:  960697  960864 | | | |
| 960895E3 960895E11 | WVA 29231 42555633 | - Posteriore/Rear - Larghezza/Width mm. 184,20 - Altezza/Height mm. 64,70 - Spessore/Thickness mm. 22,70 Omologazione/Homologation Nr.: E3 90R-01142/001 E11 90R-02A01080/42090 | Daily 65-70 MY 2006/2009/2012 |
|  | | | |
| Connessione / Connected:  960698  960514 | | | |
| 961079 | WVA 29231 500055652 | - Posteriore/Rear - Larghezza/Width mm. 184,20 - Altezza/Height mm. 64,70 - Spessore/Thickness mm. 22,70 Omologazione/Homologation Nr.: E3 90R-01142/001 | Daily 65-70 MY 2006/2009/2012 |
|  | | | |
| Connessione / Connected:  960895E3  960514 | | | |

SERIE PASTIGLIE FRENO
BRAKE PADS
JEU DE PLAQUETTES DE FREIN
SATZ BREMSBELAEGE
ТОРМОЗНЫЕ НАКЛАДКИ
JUEGO DE PASTILLAS DE FRENO

EMMERRE
spare parts for trucks and trailers

IVECO

| Applicazioni / Applications | Dettagli / Detail | Adattabile a / Adaptable to | Emmerre |
|--|---|-----------------------------|---------------|
| Daily 65-70 MY 2006/2009/2012 | <ul style="list-style-type: none"> - Anteriore/Front - Larghezza/Width mm. 174,60 - Altezza/Height mm. 85,40 - Spessore/Thickness mm. 22 <p>Omologazione/Homologation Nr.: E3 90R-01105/002 EST01</p> | WVA 29122 500055653 | 961080 |
|  | | | |
| Connessione / Connected:  961015  960864 | | | |
| Daily City 2000 | <ul style="list-style-type: none"> - Posteriore/Rear - Larghezza/Width mm. 109,60 - Altezza/Height mm. 63,80 - Spessore/Thickness mm. 20 <p>Omologazione/Homologation Nr.: E3 90R-01115/001</p> | WVA 29123 500055657 | 961081 |
|  | | | |
| Connessione / Connected:  960911E3  960863 | | | |
| Daily City MY 2006 MY 2009 MY 2012 | <ul style="list-style-type: none"> - Anteriore e posteriore/Front and Rear - Larghezza/Width mm. 164,80 - Altezza/Height mm. 66,50 - Spessore/Thickness mm. 20,30 <p>Omologazione/Homologation Nr.: E3 90R-01103/001 EST02</p> | WVA 29121 500055565 | 961082 |
|  | | | |
| Connessione / Connected:  960503E3  960864 | | | |

EMMERRE

spare parts for trucks and trailers

IVECO

SERIE PASTIGLIE FRENO BRAKE PADS JEU DE PLAQUETTES DE FREIN SATZ BREMSBELAEGE ТОРМОЗНЫЕ НАКЛАДКИ JUEGO DE PASTILLAS DE FRENO

| Emmerre | Adattabile a / Adaptable to | Dettagli / Detail | Applicazioni / Applications |
|--|-----------------------------|--|---|
| 961083 | WVA 29121 500055562 | - Anteriore e posteriore/ Front and Rear - Larghezza/Width mm. 164,80 - Altezza/Height mm. 66,50 - Spessore/Thickness mm. 20,30 Omologazione/Homologation Nr.: <u>E3 90R-01103/001 EST02</u> | Daily Restyling New Daily Turbo Daily |
| Connessione / Connected:  960909E3  960879 | | | |
| 961075 | WVA 29121 500055561 | - Anteriore e posteriore/ Front and Rear - Larghezza/Width mm. 164,80 - Altezza/Height mm. 66,50 - Spessore/Thickness mm. 20,30 Omologazione/Homologation Nr.: <u>E3 90R-01103/001 EST02</u> | Daily Restyling New Daily Turbo Daily Daily 96 |
| Connessione / Connected:  960992E3  960879 | | | |
| 961076 | WVA 29229 500055563 | - Anteriore/ Front - Larghezza/Width mm. 163,10 - Altezza/Height mm. 67,20 - Spessore/Thickness mm. 20,80 Omologazione/Homologation Nr.: <u>E3 90R-01108/001</u> | Daily MY 2006 Daily MY 2009 Daily MY 2012 |
| Connessione / Connected:  960513E3  960514 | | | |

SERIE PASTIGLIE FRENO
BRAKE PADS
JEU DE PLAQUETTES DE FREIN
SATZ BREMSBELAEGE
ТОРМОЗНЫЕ НАКЛАДКИ
JUEGO DE PASTILLAS DE FRENO

EMMERRE
spare parts for trucks and trailers

IVECO

| Applicazioni / Applications | Dettagli / Detail | Adattabile a / Adaptable to | Emmerre |
|--|--|---|---------------|
| Daily MY 2006 Daily MY 2009 Daily MY 2012 | - Larghezza/Width mm. 141,10 - Altezza/Height mm. 72,75 - Spessore/Thickness mm. 21 Omologazione/Homologation Nr.: E3 90R-01106/001 | WVA 29232 500055564 | 961077 |
|  | | | |
| Connessione / Connected:  960516E3  960517 | | | |
| Eurocargo Tector | - Anteriore e posteriore/Front and Rear - Larghezza/Width mm. 211 - Altezza/Height mm. 92,50 - Spessore/Thickness mm. 30 Omologazione/Homologation Nr.: E3 90R-01110/001 EST02 | WVA 29095 500055656 | 961078 |
|  | | | |
| Connessione / Connected:  960970E3  960839 | | | |
| Turbozeta Zeta | - Anteriore/Front - Larghezza/Width mm. 191 - Altezza/Height mm. 87 - Spessore/Thickness mm. 23 - Connettore tondo/Round Connector | WVA 29017 WVA 29024 WVA 29027 1906345 1906344 | 960904 |
|  | | | |
| Connessione / Connected:  960024 | | | |

EMMERRE

spare parts for trucks and trailers

IVECO

SERIE PASTIGLIE FRENO BRAKE PADS JEU DE PLAQUETTES DE FREIN SATZ BREMSBELAEGE ТОРМОЗНЫЕ НАКЛАДКИ JUEGO DE PASTILLAS DE FRENO

| Emmerre | Adattabile a / Adaptable to | Dettagli / Detail | Applicazioni / Applications |
|---|--|--|-----------------------------|
| 960903 | WVA 29017 WVA 29029 WVA 29026 1906070 | - Anteriore/Front - Larghezza/Width mm. 191 - Altezza/Height mm. 87 - Spessore/Thickness mm. 23 - Connettore tondo/Round Connector | Turbozeta Zeta |
| Connessione / Connected:  960024 | | | |
| 960939E3 | WVA 29067 1906297 | - Anteriore e posteriore/Front and Rear - Larghezza/Width mm. 176 - Altezza/Height mm. 78 - Spessore/Thickness mm. 22 <u>Omologazione/Homologation Nr.:</u> E3 90R-01107/001 | Eurocargo Tector Zeta |
| Connessione / Connected:  960032-960037  960932-960877-960879-960888 | | | |
| 960912E3 | WVA 29122 1906416 1906144 | - Anteriore e posteriore/Front and Rear - Larghezza/Width mm. 175 - Altezza/Height mm. 85,50 - Spessore/Thickness mm. 22 <u>Omologazione/Homologation Nr.:</u> E3 90R-01105/002 EST01 | Eurocargo Tector |
| Connessione / Connected:  960036-960068-960111  960877-960879-960888-960932 | | | |

SERIE PASTIGLIE FRENO
BRAKE PADS
JEU DE PLAQUETTES DE FREIN
SATZ BREMSBELAEGE
ТОРМОЗНЫЕ НАКЛАДКИ
JUEGO DE PASTILLAS DE FRENO

EMMERRE
spare parts for trucks and trailers

IVECO

| Applicazioni / Applications | Dettagli / Detail | Adattabile a / Adaptable to | Emmerre |
|---|--|-----------------------------------|-----------------|
| Eurocargo Tector | <ul style="list-style-type: none"> - Anteriore e posteriore/<i>Front and Rear</i> - Larghezza/<i>Width</i> mm. 175 - Altezza/<i>Height</i> mm. 85 - Spessore/<i>Thickness</i> mm. 22 - Connettore tondo/<i>Round Connector</i> <p>Omologazione/Homologation Nr.: E3 90R-01105/001 EST01</p> | WVA 29065 WVA 29835 1906298 | 960029E3 |
|  | | | |
| Connessione / Connected:  960036  960877-960879-960888-960932 | | | |
| Eurocargo Tector | <ul style="list-style-type: none"> - Anteriore e posteriore/<i>Front and Rear</i> - Larghezza/<i>Width</i> mm. 175,50 - Altezza/<i>Height</i> mm. 77 - Spessore/<i>Thickness</i> mm. 21 - Connettore tondo/<i>Round Connector</i> <p>Omologazione/Homologation Nr.: E3 90R-01107/001</p> | WVA 29033 WVA 29302 1906043 | 960902E3 |
|  | | | |
| Connessione / Connected:  960037  960877-960879-960888-960932 | | | |
| Eurocargo Eurofire | <ul style="list-style-type: none"> - Anteriore/<i>Front</i> - Larghezza/<i>Width</i> mm. 206 - Altezza/<i>Height</i> mm. 110 - Spessore/<i>Thickness</i> mm. 25 <p>Omologazione/Homologation Nr.: E3 90R-01111/001</p> | WVA 29032 1906170 | 960938E3 |
|  | | | |
| Connessione / Connected:  960048-960049  960878-960880 | | | |

| Emmerre | Adattabile a / Adaptable to | Dettagli / Detail | Applicazioni / Applications |
|--|--|---|--|
| 960897 | WVA 29068 1906353 | - Anteriore/Front - Larghezza/Width mm. 200 - Altezza/Height mm. 95 - Spessore/Thickness mm. 20 - Connettore ovale/Oval connector | Eurocargo Restyling Eurocargo Tector Eurofire |
|  | | Connessione / Connected:  960409  960852 | |
| 960970E3 | WVA 29095 2996468 2992336 500055019 | - Anteriore e posteriore/Front and Rear - Larghezza/Width mm. 211 - Altezza/Height mm. 92,50 - Spessore/Thickness mm. 30 - Con kit accessori/With kit accessories - Con piastre/With plates | Eurocargo Tector |
|  | | Omologazione/Homologation Nr.: <u>E3 90R-01110/001 EST02</u> | |
| Connessione / Connected:  960020-960104-960402-960506-960507  960839-960878-960880 | | | |
| 960969E3 | WVA 29088 WVA 29091 1906467 | - Anteriore e posteriore/Front and Rear - Larghezza/Width mm. 175,50 - Altezza/Height mm. 85,60 - Spessore/Thickness mm. 26 | Eurocargo Tector |
|  | | Omologazione/Homologation Nr.: <u>E3 90R-01116/001 EST02</u> | |
| Connessione / Connected:  960232  960805-960881 | | | |

SERIE PASTIGLIE FRENO
BRAKE PADS
JEU DE PLAQUETTES DE FREIN
SATZ BREMSBELAEGE
ТОРМОЗНЫЕ НАКЛАДКИ
JUEGO DE PASTILLAS DE FRENO

EMMERRE
spare parts for trucks and trailers

IVECO

| Applicazioni / Applications | Dettagli / Detail | Adattabile a / Adaptable to | Emmerre |
|--|--|--|-----------------|
| Eurocargo Tector | <ul style="list-style-type: none"> - Anteriore e posteriore / <i>Front and Rear</i> - Larghezza / <i>Width</i> mm. 175 - Altezza / <i>Height</i> mm. 95 - Spessore / <i>Thickness</i> mm. 27 | WVA 29256 2996518 42559248 | 961033 |
|  | | | |
| Eurocargo Tector | <ul style="list-style-type: none"> - Anteriore e posteriore / <i>Front and Rear</i> - Larghezza / <i>Width</i> mm. 175 - Altezza / <i>Height</i> mm. 95 - Spessore / <i>Thickness</i> mm. 27 | WVA 29256 2996520 42559249 | 961034 |
|  | | | |
| Eurocargo Eurostar Eurotech | <ul style="list-style-type: none"> - Anteriore / <i>Front</i> - Larghezza / <i>Width</i> mm. 241 - Altezza / <i>Height</i> mm. 125 - Spessore / <i>Thickness</i> mm. 25 <p>Omologazione / Homologation Nr.: E3 90R-01109/001</p> | WVA 29011 2992479 1906459 1906191 | 960937E3 |
|  | | | |
| Connessione / Connected:  960033-960034  960839-960878-960880-960908 | | | |











Pastiglie Freno
Brake Pads

EMMERRE

spare parts for trucks and trailers

IVECO

SERIE PASTIGLIE FRENO BRAKE PADS JEU DE PLAQUETTES DE FREIN SATZ BREMSBELAEGE ТОРМОЗНЫЕ НАКЛАДКИ JUEGO DE PASTILLAS DE FRENO

| Emmerre | Adattabile a / Adaptable to | Dettagli / Detail | Applicazioni / Applications | |
|--|--|--|---|--|
| 960944E1 960944E3 | WVA 29087 WVA 29105 WVA 29253 2996515 1906439 2992348 | 2995637 2995809 2992476 2995819 2995938 2996378 | - Anteriore e posteriore/ Front and Rear - Larghezza/Width mm. 247,20 - Altezza/Height mm. 109,70 - Spessore/Thickness mm. 30 - Con molle/With springs - Con kit accessori/With kit accessories - Con piastre/With plates | Eurocargo Eurotech Eurotrakker Stralis |
|  | | | | |
| Omologazione/Homologation Nr.: E1 90R-011363/008 E3 90R-01101/001 EST03 | | | | |
| Connessione / Connected:  960038-960053-960019-960404-960405-960406  960839-960908 | | | | |
| 960794E3 | WVA 29252 500054632 500086004 500086211 | 500086211 | - Anteriore e posteriore/ Front and Rear - Larghezza/Width mm. 248 - Altezza/Height mm. 109,50 - Spessore/Thickness mm. 30 - Con molle/With springs - Con kit accessori/With kit accessories - Con piastre/With plates Knorr system SB/SN7 - Protec 5 - Nostro Brevetto/Our patent | Eurocargo Eurotech Eurotrakker Stralis Stralis 570XP |
|  | | | | |
| EMMERRE MODIFICATION PATENT PENDING | | | | |
| Connessione / Connected:  960038-960053-960019-960404-960405-960406 | | | | |
| 961041 | WVA 29088 500055372 5801543644 2996430 | 5801543644 | - Anteriore e posteriore/ Front and Rear - Larghezza/Width mm. 175,50 - Altezza/Height mm. 85,60 - Spessore/Thickness mm. 26 - Con indicatori di usura e kit fissaggio/ With wear indicators and fixed kit | Eurocargo Tector |
|  | | | | |
| Omologazione/Homologation Nr.: E3 90R-01116/001EST02 | | | | |
| Connessione / Connected:  960232  960805 | | | | |

SERIE PASTIGLIE FRENO
BRAKE PADS
JEU DE PLAQUETTES DE FREIN
SATZ BREMSBELAEGE
ТОРМОЗНЫЕ НАКЛАДКИ
JUEGO DE PASTILLAS DE FRENO

EMMERRE
spare parts for trucks and trailers

IVECO BUS

| Applicazioni / Applications | Dettagli / Detail | Adattabile a / Adaptable to | Emmerre |
|--|---|---|---|
| City Bus Turbocity | <ul style="list-style-type: none"> - Anteriore/Front - Larghezza/Width mm. 163 - Altezza/Height mm. 111 - Spessore/Thickness mm. 28 <p>Omologazione/Homologation Nr.: E3 90R-01126/001</p> | WVA 29016 WVA 29018 1906216 | 960011E3  |
| Connessione / Connected:  960007  960508-960931 | | | |
| 370S 490.18 Cityclass Euroclass Eurorider | <ul style="list-style-type: none"> - Anteriore/Front - Larghezza/Width mm. 179 - Altezza/Height mm. 106 - Spessore/Thickness mm. 20 - Connettore tondo/Round Connector - Lunghezza/Lenght 45 mm <p>Omologazione/Homologation Nr.: E3 90R-01124/001</p> | WVA 29074 WVA 29075 WVA 29186 42536301 42535773 42535775 93161314 | 960952E3  |
| Connessione / Connected:  960002-960003  960508-960931 | | | |
| Europolis Menarini | <ul style="list-style-type: none"> - Anteriore e posteriore/Front and Rear - Larghezza/Width mm. 249 - Altezza/Height mm. 117,50 - Spessore/Thickness mm. 30 <p>Omologazione/Homologation Nr.: E3 90R-01125/001</p> | WVA 29150 2995552 MDP 5083 | 960901E3  |
| Connessione / Connected:  960222-960224  960676 | | | |

EMMERRE

spare parts for trucks and trailers

IVECO BUS

SERIE PASTIGLIE FRENO
BRAKE PADS
JEU DE PLAQUETTES DE FREIN
SATZ BREMSBELAEGE
ТОРМОЗНЫЕ НАКЛАДКИ
JUEGO DE PASTILLAS DE FRENO

| Emmerre | Adattabile a / Adaptable to | Dettagli / Detail | Applicazioni / Applications |
|---|--|---|-----------------------------|
| 960950E3 | WVA 29688 1906118 | - Anteriore/Front - Larghezza/Width mm. 109,60 - Altezza/Height mm. 99 - Spessore/Thickness mm. 25 Omologazione/Homologation Nr.: E3 90R-01129/001 | Irisbus |
|  | | | |
| Connessione / Connected:  960221 | | | |
| 960798E3 | WVA 29131 5006028410 2996068 | - Anteriore/Front - Larghezza/Width mm. 250 - Altezza/Height mm. 118 - Spessore/Thickness mm. 30 Omologazione/Homologation Nr.: E3 90R-01119/001 EST02 | City Elis Arway |
|  | | | |
| Connessione / Connected:  960500  960807-960822 | | | |
| 960944E1 960944E3 | WVA 29253 WVA 29087 WVA 29105 2996515 1906439 2992348 | - Anteriore e posteriore/Front and Rear - Larghezza/Width mm. 247,20 - Altezza/Height mm. 109,70 - Spessore/Thickness mm. 30 - Con molle/With springs - Con kit accessori/With kit accessories - Con piastre/With plates Omologazione/Homologation Nr.: E1 90R-011363/008 E3 90R-01101/001 EST03 | Menarini 231/4 |
|  | | | |
| Connessione / Connected:  960583 | | | |

SERIE PASTIGLIE FRENO
BRAKE PADS
JEU DE PLAQUETTES DE FREIN
SATZ BREMSBELAEGE
ТОРМОЗНЫЕ НАКЛАДКИ
JUEGO DE PASTILLAS DE FRENO

EMMERRE
spare parts for trucks and trailers
**KÄSSBOHRER
BUS**

| Applicazioni / Applications | Dettagli / Detail | Adattabile a / Adaptable to | Emmerre |
|-----------------------------|--|---------------------------------------|-----------------|
| Neoplan Setra Bus | <ul style="list-style-type: none"> - Anteriore/Front - Larghezza/Width mm. 139,50 - Altezza/Height mm. 121 - Spessore/Thickness mm. 32 <p>Omologazione/Homologation Nr.: E3 90R-01128/001</p> | WVA 29747 8284000209 8285000235 | 960961E3 |



| Connessione / Connected: | |
|--|--|
|  960313 |  960975 |

| | | | |
|-----------|---|---|-----------------|
| Setra Bus | <ul style="list-style-type: none"> - Anteriore/Front - Larghezza/Width mm. 179 - Altezza/Height mm. 112 - Spessore/Thickness mm. 22 <p>Omologazione/Homologation Nr.: E3 90R-01127/001</p> | WVA 29582 8284000197 8284058204 8284058197 | 960960E3 |
|-----------|---|---|-----------------|



| Connessione / Connected: | |
|--|--|
|  960314 |  960976 |

| | | | |
|---------------------------|---|--------------------------|-----------------|
| Setra Bus 200-S 208 | <ul style="list-style-type: none"> - Larghezza/Width mm. 109,60 - Altezza/Height mm. 99 - Spessore/Thickness mm. 25 <p>Omologazione/Homologation Nr.: E3 90R-01129/001</p> | WVA 29688 82840002070 | 960950E3 |
|---------------------------|---|--------------------------|-----------------|



EMMERRE

spare parts for trucks and trailers

KÄSSBOHRER BUS

SERIE PASTIGLIE FRENO
BRAKE PADS
JEU DE PLAQUETTES DE FREIN
SATZ BREMSBELAEGE
ТОРМОЗНЫЕ НАКЛАДКИ
JUEGO DE PASTILLAS DE FRENO

| Emmerre | Adattabile a / Adaptable to | Dettagli / Detail | Applicazioni / Applications |
|---|---|--|---|
| 960956E1 960956E3 | WVA 29113 WVA 29114 WVA 29084 8285408453 8285388535 8285408534 | - Larghezza/Width mm. 250 - Altezza/Height mm. 118 - Spessore/Thickness mm. 28 Omologazione/Homologation Nr.: <u>E3 90R-01113/001</u> <u>E1 90R-011363/005</u> | Serie 3000 |
|  | | | Connessione / Connected:  960976 |

SERIE PASTIGLIE FRENO
BRAKE PADS
JEU DE PLAQUETTES DE FREIN
SATZ BREMSBELAEGE
ТОРМОЗНЫЕ НАКЛАДКИ
JUEGO DE PASTILLAS DE FRENO

EMMERRE
spare parts for trucks and trailers

LECINENA

| Applicazioni / Applications | Dettagli / Detail | Adattabile a / Adaptable to | Emmerre |
|--|---|---|------------------------------------|
| Karosa Bus 6455 FD 22/0 FD 22/120 | <ul style="list-style-type: none"> - Anteriore e posteriore/<i>Front and Rear</i> - Larghezza/<i>Width</i> mm. 247,20 - Altezza/<i>Height</i> mm. 109,70 - Spessore/<i>Thickness</i> mm. 30 - Con molle/<i>With springs</i> - Con kit accessori/<i>With kit accessories</i> - Con piastre/<i>With plates</i> <p>Omologazione/Homologation Nr.: E1 90R-011363/008 E3 90R-01101/001 EST03</p> | WVA 29253 WVA 29087 WVA 29105 WVA 29108 WVA 29059 | 960944E1 960944E3 |
|  | | | |
| Connessione / Connected:  960397-960399 | | | |

| Emmerre | Adattabile a / Adaptable to | Dettagli / Detail | Applicazioni / Applications | |
|---|-----------------------------|-------------------|---|-----------------------------|
| 960969E3 | WVA 29088 | 81508206042 | <p>- Anteriore e posteriore/ Front and Rear</p> <p>- Larghezza/Width mm. 175,50</p> <p>- Altezza/Height mm. 85,60</p> <p>- Spessore/Thickness mm. 26</p> <p>Omologazione/Homologation Nr.: E3 90R-01116/001 EST02</p> | <p>L 2000</p> <p>L 2100</p> |
| | WVA 29145 | 81508205017 | | |
| | WVA 29184 | 81508205082 | | |
| | WVA 29197 | 81508206008 | | |
| | 81508206020 | 81508206033 | | |
| | 81508205029 | 81508206057 | | |
| | 81508205025 | 81508206059 | | |
| <p>Connessione / Connected:  960320-960328-960343-960346  960553-960803</p> | | | | |
| 960955E3 | WVA 29055 | 81508206009 | <p>- Anteriore e posteriore/ Front and Rear</p> <p>- Larghezza/Width mm. 175,80</p> <p>- Altezza/Height mm. 82,50</p> <p>- Spessore/Thickness mm. 22</p> <p>Omologazione/Homologation Nr.: E3 90R-01107/002</p> | <p>L 2000</p> <p>L 2100</p> |
| | WVA 29057 | | | |
| | 81508206009 | | | |
| | 81508206011 | | | |
| <p>Connessione / Connected:  960320-960328-960343-960346  960553-960803</p> | | | | |
| 960948E3 | WVA 29095 | 81508206057 | <p>- Anteriore/Front</p> <p>- Larghezza/Width mm. 211</p> <p>- Altezza/Height mm. 92,50</p> <p>- Spessore/Thickness mm. 30</p> <p>- Con molle/With springs</p> <p>- Con kit accessori/With kit accessories</p> <p>- Con piastre/With plates</p> <p>Omologazione/Homologation Nr.: E3 90R-01110/001 EST02</p> | <p>M 2000</p> |
| | WVA 29093 | | | |
| | 81508206060 | | | |
| | 81508206058 | | | |
| | 81508206022 | | | |
| | 81508206033 | | | |
| 81508206057 | | | | |
| | 81508206059 | | | |
| <p>Connessione / Connected:  960329  960811</p> | | | | |



SERIE PASTIGLIE FRENO
BRAKE PADS
JEU DE PLAQUETTES DE FREIN
SATZ BREMSBELAEGE
ТОРМОЗНЫЕ НАКЛАДКИ
JUEGO DE PASTILLAS DE FRENO

EMMERRE
spare parts for trucks and trailers

MAN



| Applicazioni / Applications | Dettagli / Detail | Adattabile a / Adaptable to | Emmerre |
|-----------------------------|---|--|-------------------------------------|
| TGL TGM | <ul style="list-style-type: none"> - Anteriore e posteriore/<i>Front and Rear</i> - Larghezza/<i>Width</i> mm. 173,60 - Altezza/<i>Height</i> mm. 84 - Spessore/<i>Thickness</i> mm. 27/34 <p>Omologazione/Homologation Nr.: E3 90R-01132/001 EST01 E11 90R-02A01080/42091</p> | WVA 29115 WVA 29116 WVA 29148 81508206043 81508206054 81508205085 | 960998E3 960998E11 |



Connessione / Connected:  960344-960346-960419  960553

| | | | | |
|---|---|--|---|------------------------------------|
| F 90 F 2000 M 2000 TGA TGX BUS | <ul style="list-style-type: none"> - Anteriore e posteriore/<i>Front and Rear</i> - Larghezza/<i>Width</i> mm. 250 - Altezza/<i>Height</i> mm. 118 - Spessore/<i>Thickness</i> mm. 28 <p>Omologazione/Homologation Nr.: E1 90R-011363/005 E3 90R-01113/001</p> | WVA 29113 WVA 29114 WVA 29084 81508206046 81508206014 81508206038 | 81508206025 81508206005 81508206015 | 960956E1 960956E3 |
|---|---|--|---|------------------------------------|



Connessione / Connected:  960321-960322-960393-960343-960100  960807-960822-960976

| | | | | |
|------------|---|---|---|-----------------|
| TGA TGM | <ul style="list-style-type: none"> - Anteriore e posteriore/<i>Front and Rear</i> - Larghezza/<i>Width</i> mm. 250 - Altezza/<i>Height</i> mm. 118 - Spessore/<i>Thickness</i> mm. 30 <p>Omologazione/Homologation Nr.: E1 90R-011363/004 E3 90R-01119/001 EST02</p> | WVA 29131 81508206041 81508205072 81508206051 81508206052 | 20976509 21309468 503140088 85107768 | 960984E3 |
|------------|---|---|---|-----------------|



Connessione / Connected:  960100-960393-960129  960807-960822

I riferimenti indicati non sono originali ma perfettamente intercambiabili. I codici originali e le case costruttrici sono indicati a puro titolo informativo
The details described are not original but perfectly interchangeable. The original references and manufacturer names are given for information purposes only.

| Emmerre | Adattabile a / Adaptable to | Dettagli / Detail | Applicazioni / Applications |
|--|---|--|--|
| 960944E1 960944E3 | WVA 29253 WVA 29087 WVA 29105 WVA 29108 WVA 29059 81508206030 81508205099 | <ul style="list-style-type: none"> - Anteriore e posteriore/ Front and Rear - Larghezza/Width mm. 247,20 - Altezza/Height mm. 109,70 - Spessore/Thickness mm. 30 - Con molle/With springs - Con kit accessori/With kit accessories - Con piastre/With plates <p>Omologazione/Homologation Nr.: E1 90R-011363/008 E3 90R-01101/001 EST03</p> | F 2000 M 2000 TGA TGM TGS TGX |
| Connessione / Connected:  960321 | | | |
| 960794E3 | WVA 29252 81508206070 81508206056 | <ul style="list-style-type: none"> - Anteriore e posteriore/ Front and Rear - Larghezza/Width mm. 248 - Altezza/Height mm. 109,50 - Spessore/Thickness mm. 30 - Con molle/With springs - Con kit accessori/With kit accessories - Con piastre/With plates Knorr system SB/SN7 - Protec 5 - Nostro Brevetto/Our patent <p>Omologazione/Homologation Nr.: E3 90R-02A0794/4091</p> | TGA TGM TGS TGX |
| Connessione / Connected:  960321-960480 | | | |
| 961041 | WVA 29088 81508206020 81508206042 81508205025 81508205029 | <ul style="list-style-type: none"> - Anteriore e posteriore/ Front and Rear - Larghezza/Width mm. 175,50 - Altezza/Height mm. 85,60 - Spessore/Thickness mm. 26 - Con indicatori di usura e kit fissaggio/With wear indicators and fixed kit <p>Omologazione/Homologation Nr.: E3 90R-01116/001 EST02</p> | L 2000 L 2100 |
| Connessione / Connected:  960320-960328-960343-960346  960553-960803 | | | |



EMMERRE
MODIFICATION

PATENT
PENDING



SERIE PASTIGLIE FRENO
BRAKE PADS
JEU DE PLAQUETTES DE FREIN
SATZ BREMSBELAEGE
ТОРМОЗНЫЕ НАКЛАДКИ
JUEGO DE PASTILLAS DE FRENO

EMMERRE
spare parts for trucks and trailers

MAN

| Applicazioni / Applications | Dettagli / Detail | Adattabile a / Adaptable to | Emmerre |
|---|---|--|---------------|
| TGS TGX | <ul style="list-style-type: none"> - Anteriore e posteriore/<i>Front and Rear</i> - Larghezza/<i>Width</i> mm. 217,50 - Altezza/<i>Height</i> mm. 107,60 - Spessore/<i>Thickness</i> mm. 30,50 - Con kit fissaggio/<i>With fixed kit</i> <p>Omologazione/Homologation Nr.: E11 90R-02A0904/17124</p> | WVA 29279 81508206065 81508206066 81508205112 | 960793 |
|  | | | |
| Connessione / Connected:  960100 | | | |

EMMERRE

spare parts for trucks and trailers

MERCEDES

SERIE PASTIGLIE FRENO
BRAKE PADS
JEU DE PLAQUETTES DE FREIN
SATZ BREMSBELÄGE
ТОРМОЗНЫЕ НАКЛАДКИ
JUEGO DE PASTILLAS DE FRENO

| Emmerre | Adattabile a / Adaptable to | Dettagli / Detail | Applicazioni / Applications |
|---|--|---|-----------------------------|
| 960777 | WVA 23020 0004214210 | - Posteriore/Rear - Larghezza/Width mm. 105 - Altezza/Height mm. 52,80 - Spessore/Thickness mm. 17,50 | Vito |
| Connessione / Connected:  960334 | | | |
| 960921 | WVA 21576 WVA 21577 WVA 23990 WVA 23991 0024203920 0024209920 | - Anteriore/Front - Larghezza/Width mm. 156 - Altezza/Height mm. 64 - Spessore/Thickness mm. 20 | Sprinter Vito |
| Connessione / Connected:  960324-960333  960915 | | | |
| 960926 | WVA 21278 WVA 21904 0024204820 0034200020 6384230110 | - Posteriore/Rear - Larghezza/Width mm. 63 - Altezza/Height mm. 57 - Spessore/Thickness mm. 17 | Vito |
| Connessione / Connected:  960334  960915 | | | |



SERIE PASTIGLIE FRENO
BRAKE PADS
JEU DE PLAQUETTES DE FREIN
SATZ BREMSBELAEGE
ТОРМОЗНЫЕ НАКЛАДКИ
JUEGO DE PASTILLAS DE FRENO

EMMERRE
spare parts for trucks and trailers

MERCEDES

| Applicazioni / Applications | Dettagli / Detail | Adattabile a / Adaptable to | Emmerre |
|---|--|--|-----------------|
| Vito Viano | <ul style="list-style-type: none"> - Anteriore/Front - Larghezza/Width mm. 165 - Altezza/Height mm. 60,20 - Spessore/Thickness mm. 20,20 | WVA 24007 0004216110 0014210910 0064204320 0034207910 | 960792 |
|  | | | |
| Connessione / Connected:  960421 | | | |
| Viano Vito | <ul style="list-style-type: none"> - Posteriore/Rear - Larghezza/Width mm. 102 - Altezza/Height mm. 48,50 - Spessore/Thickness mm. 17,70 | WVA 24008 0004216210 0014211010 0064204420 | 960451 |
|  | | | |
| Connessione / Connected:  960450  960825 | | | |
| Sprinter | <ul style="list-style-type: none"> - Anteriore e posteriore/Front and Rear - Larghezza/Width mm. 165 - Altezza/Height mm. 73 - Spessore/Thickness mm. 20 <p>Omologazione/Homologation Nr.: E3 90R-01103/002 EST01</p> | WVA 29076 WVA 29153 0004237110 0024204120 0024204220 0034201720 9024210110 | 960920E3 |
|  | | | |
| Connessione / Connected:  960323-960324  960915 | | | |

EMMERRE

spare parts for trucks and trailers

MERCEDES

SERIE PASTIGLIE FRENO
BRAKE PADS
JEU DE PLAQUETTES DE FREIN
SATZ BREMSBELAEGE
ТОРМОЗНЫЕ НАКЛАДКИ
JUEGO DE PASTILLAS DE FRENO

| Emmerre | Adattabile a / Adaptable to | Dettagli / Detail | Applicazioni / Applications |
|--|--|--|-----------------------------|
| 960776 | WVA 29190 0044206920 | - Posteriore/Rear - Larghezza/Width mm. 137 - Altezza/Height mm. 63 - Spessore/Thickness mm. 19 | Sprinter 3/5 ton |
|  | | | |
| Connessione / Connected:  960565  960825 | | | |
| 960922 | WVA 21592 WVA 21593 WVA 23901 WVA 23902 0024204020 0024206020 9024230510 | - Posteriore/Rear - Larghezza/Width mm. 156 - Altezza/Height mm. 55 - Spessore/Thickness mm. 18 | Sprinter |
|  | | | |
| Connessione / Connected:  960390-960391  960915 | | | |
| 960890 | WVA 29192 0054205220 0044208320 0054202120 | - Anteriore/Front - Larghezza/Width mm. 163,30 - Altezza/Height mm. 67,10 - Spessore/Thickness mm. 20,90 | Sprinter L.T. |
|  | | | |
| Connessione / Connected:  960564-960565-960421  960435-960824-960825 | | | |

SERIE PASTIGLIE FRENO
BRAKE PADS
JEU DE PLAQUETTES DE FREIN
SATZ BREMSBELAEGE
ТОРМОЗНЫЕ НАКЛАДКИ
JUEGO DE PASTILLAS DE FRENO

EMMERRE
spare parts for trucks and trailers

MERCEDES

| Applicazioni / Applications | Dettagli / Detail | Adattabile a / Adaptable to | Emmerre |
|--|--|---|---------------|
| Sprinter L.T. | <ul style="list-style-type: none"> - Anteriore/Front - Larghezza/Width mm. 169,10 - Altezza/Height mm. 73,20 - Spessore/Thickness mm. 20,80 | WVA 29200 0044208220 0044206820 0054205320 | 960427 |
|  | | | |
| Connessione / Connected:  960564  960824 | | | |
| Sprinter L.T. | <ul style="list-style-type: none"> - Posteriore/Rear - Larghezza/Width mm. 165 - Altezza/Height mm. 79 - Spessore/Thickness mm. 20,80 | WVA 29217 0044208120 0054207420 0064202220 0064204520 | 960896 |
|  | | | |
| Connessione / Connected:  960422  960825 | | | |
| Sprinter from 2006 Vario | <ul style="list-style-type: none"> - Anteriore/Front - Larghezza/Width mm. 164,50 - Altezza/Height mm. 67,80 - Spessore/Thickness mm. 20 <p>Omologazione/Homologation Nr.: E3 90R-01102/001</p> | WVA 29237 0034204620 | 960775 |
|  | | | |
| Connessione / Connected:  960124  960916 | | | |

EMMERRE

spare parts for trucks and trailers

MERCEDES

SERIE PASTIGLIE FRENO
BRAKE PADS
JEU DE PLAQUETTES DE FREIN
SATZ BREMSBELÄGE
ТОРМОЗНЫЕ НАКЛАДКИ
JUEGO DE PASTILLAS DE FRENO

| Emmerre | Adattabile a / Adaptable to | Dettagli / Detail | Applicazioni / Applications |
|--|---|--|---|
| 960946E3  | 0014201520 WVA 29835 0034204420 0024206220 0044204820 6704202820 6694200020 6694200120 | - Anteriore/Front - Larghezza/Width mm. 175 - Altezza/Height mm. 85 - Spessore/Thickness mm. 22 Omologazione/Homologation Nr.: E3 90R-01105/001 EST01 | Sprinter from 2006 |
| | Connesione / Connected:  960125-960319-960318-960446-960447-960073-960074  960916 | | |
| 960967E3  | WVA 20784 6694210008 6015860042 0014201420 0034200720 | - Anteriore/Front - Larghezza/Width mm. 149 - Altezza/Height mm. 75 - Spessore/Thickness mm. 18 Omologazione/Homologation Nr.: E3 90R-01121/002 | 508D 510 L 608D L 613D |
| | Connesione / Connected:  960335  960842-960916 | | |
| 960998E3 960998E11  | WVA 29115 0034207220 WVA 29116 0034201120 WVA 29148 0034201220 0044206120 0034206620 0034207320 | - Anteriore e posteriore/Front and Rear - Larghezza/Width mm. 173,60 - Altezza/Height mm. 84 - Spessore/Thickness mm. 27/34 Omologazione/Homologation Nr.: E3 90R-01132/001 EST01 E11 90R-02A01080/42091 | Atego Atego II Atego III Antos |
| | Connesione / Connected:  960336-960337-960338-960346 | | |

SERIE PASTIGLIE FRENO
BRAKE PADS
JEU DE PLAQUETTES DE FREIN
SATZ BREMSBELAEGE
ТОРМОЗНЫЕ НАКЛАДКИ
JUEGO DE PASTILLAS DE FRENO

EMMERRE
spare parts for trucks and trailers

MERCEDES

| Applicazioni / Applications | Dettagli / Detail | Adattabile a / Adaptable to | | Emmerre |
|---|--|---|--|------------------------------------|
| Atego Atego II Atego III | <ul style="list-style-type: none"> - Anteriore/Front - Larghezza/Width mm. 211 - Altezza/Height mm. 92,50 - Spessore/Thickness mm. 30 - Con molle/With springs - Con kit accessori/With kit accessories - Con piastre/With plates <p>Omologazione/Homologation Nr.: E3 90R-01110/001 EST02</p> | WVA 29095 WVA 29093 WVA 29145 WVA 29184 WVA 29197 0024207920 0024207820 | 0004210710 0004210810 0004215010 0004215110 0014210710 | 960948E3 |
|  | | | | |
| <p>Connessione / Connected:  960339-960341</p> | | | | |
| Actros 22,5" Atego Atego II Axor II MP2 MP3 Travego | <ul style="list-style-type: none"> - Anteriore e posteriore/Front and Rear - Larghezza/Width mm. 247,20 - Altezza/Height mm. 109,70 - Spessore/Thickness mm. 30 - Con molle/With springs - Con kit accessori/With kit accessories - Con piastre/With plates <p>Omologazione/Homologation Nr.: E1 90R-011363/008 E3 90R-01101/001 EST03</p> | WVA 29253 WVA 29087 WVA 29105 0034202220 0034201620 0004214310 | 0004210510 0034202020 0034203520 | 960944E1 960944E3 |
|  | | | | |
| <p>Connessione / Connected:  960316-960317</p> | | | | |
| Actros Actros MP2 Actros MP3 Axor Axor II Antos Axles TE5 Axles TL5 Axles TZ5 | <ul style="list-style-type: none"> - Anteriore e posteriore/Front and Rear - Larghezza/Width mm. 248 - Altezza/Height mm. 109,50 - Spessore/Thickness mm. 30 - Con molle/With springs - Con kit accessori/With kit accessories - Con piastre/With plates - Knorr system SB/SN7 - Protec 5 - Nostro Brevetto/Our patent <p>Omologazione/Homologation Nr.: E3 90R-02A0794/4091</p> | WVA 29252 0064201020 0064201120 0044202220 0044206020 | | 960794E3 |
|  | | | | |
| <p>PATENT PENDING</p> <p>EMMERRE MODIFICATION</p> | | | | |
| <p>Connessione / Connected:  960316-960317</p> | | | | |

Pastiglie Freno
Brake Pads

| Emmerre | Adattabile a / Adaptable to | Dettagli / Detail | Applicazioni / Applications |
|--|--|--|--|
| 960797E3    | WVA 29246 WVA 29247 0064201420 0064205220 | <ul style="list-style-type: none"> - Anteriore/Front - Larghezza/Width mm. 244,60 - Altezza/Height mm. 113,70 - Spessore/Thickness mm. 30 - Con molle/With springs - Con kit accessori/With kit accessories - Con piastre/With plates - Nostro Brevetto/Our patent - Knorr system SM7 <p>Omologazione/Homologation Nr.: E3 90R-02A0797/4091</p> | Actros MP2 Actros MP3 Actros MP4 |
| | | Connessione / Connected:  960316-960317 | |
| 960796E3    | WVA 29244 WVA 29245 0064201520 0064205320 | <ul style="list-style-type: none"> - Posteriore/Rear - Larghezza/Width mm. 207,60 - Altezza/Height mm. 113,70 - Spessore/Thickness mm. 30 - Con molle/With springs - Con kit accessori/With kit accessories - Con piastre/With plates - Knorr system SL7 - Nostro Brevetto/Our patent <p>Omologazione/Homologation Nr.: E3 90R-02A0796/4091</p> | Actros MP2 Actros MP3 Actros MP4 |
| | | Connessione / Connected:  960316 | |
| 960891  | WVA 29158 0044207020 | <ul style="list-style-type: none"> - Posteriore/Rear - Larghezza/Width mm. 210,60 - Altezza/Height mm. 108 - Spessore/Thickness mm. 30 - Con molle/With springs <p>Omologazione/Homologation Nr.: E3 90R-01134/001 EST02</p> | Axles Mercedes for Trailers TE 5 TL 5 TZ 5 |
| | | Connessione / Connected:  960316 | |

SERIE PASTIGLIE FRENO
BRAKE PADS
JEU DE PLAQUETTES DE FREIN
SATZ BREMSBELAEGE
ТОРМОЗНЫЕ НАКЛАДКИ
JUEGO DE PASTILLAS DE FRENO

EMMERRE
spare parts for trucks and trailers

MERCEDES

| Applicazioni / Applications | Dettagli / Detail | Adattabile a / Adaptable to | | Emmerre |
|-----------------------------|---|-----------------------------|------------|-----------------|
| Avancity | - Anteriore e posteriore / Front and Rear | WVA 29030 | 0034208420 | 960956E1 |
| Europolis | - Larghezza / Width mm. 250 | WVA 29083 | 0004205520 | 960956E3 |
| Evobus | - Altezza / Height mm. 118 | WVA 29084 | 0004200276 | |
| Menarini | - Spessore / Thickness mm. 28 | MDP5033 | 3564210210 | |
| Neoplan | | MDP5017 | | |
| 0303 | Omologazione / Homologation Nr.: | 0024200820 | | |
| 0305 | E1 90R-011363/005 | | | |
| 0404 | E3 90R-01113/001 | | | |
| Tourismo | | | | |





Connessione / Connected:  960315-960693  960914

EMMERRE

spare parts for trucks and trailers

NISSAN





SERIE PASTIGLIE FRENO
BRAKE PADS
JEU DE PLAQUETTES DE FREIN
SATZ BREMSBELAEGE
ТОРМОЗНЫЕ НАКЛАДКИ
JUEGO DE PASTILLAS DE FRENO

| Emmerre | Adattabile a / Adaptable to | Dettagli / Detail | Applicazioni / Applications |
|---|--|--|--|
| 960872E3 | WVA 29034 WVA 29035 WVA 29706 -06903100-0 41060D6225 | - Anteriore/Front - Larghezza/Width mm. 166 - Altezza/Height mm. 62 - Spessore/Thickness mm. 17 Omologazione/Homologation Nr.: E3 90R-01123/001 | Atleon 100 Atleon 120 Cabstar Eco T100 Trade |
| Connessione / Connected:  960055-960056 | | | |
| 960874E3 | WVA 23435 WVA 23437 WVA 23436 410609X226 | - Anteriore e posteriore/Front and Rear - Larghezza/Width mm. 169 - Altezza/Height mm. 65 - Spessore/Thickness mm. 18 Omologazione/Homologation Nr.: E3 90R-01122/001 | Cabstar 120 L.T. |
| Connessione / Connected:  960059 | | | |
| 960875E3 | WVA 29121 410609X126 D40609X60A D4060MB40A | - Anteriore e posteriore/Front and Rear - Larghezza/Width mm. 164,80 - Altezza/Height mm. 66,50 - Spessore/Thickness mm. 20,30 Omologazione/Homologation Nr.: E3 90R-01103/001 EST02 | Atleon 120 |
| Connessione / Connected:  960057-960058-960522  960819 | | | |

SERIE PASTIGLIE FRENO
BRAKE PADS
JEU DE PLAQUETTES DE FREIN
SATZ BREMSBELAEGE
ТОРМОЗНЫЕ НАКЛАДКИ
JUEGO DE PASTILLAS DE FRENO

EMMERRE
spare parts for trucks and trailers

NISSAN

| Applicazioni / Applications | Dettagli / Detail | Adattabile a / Adaptable to | Emmerre |
|---|--|--|---------------|
| 140.75 165.75 | - Anteriore/Front - Larghezza/Width mm. 214 - Altezza/Height mm. 112 - Spessore/Thickness mm. 25 | WVA 29099 WVA 29100 069030060 | 960991 |
| | |  | |
| Cabstar 28.11 35.13 35.15 | - Anteriore/Front - Larghezza/Width mm. 163,10 - Altezza/Height mm. 66,70 - Spessore/Thickness mm. 20,80 | WVA 29229 WVA 29230 D1060MB200 D1060MB600 D1060MB60A | 960461 |
| | |  | |
| Connessione / Connected:  960462 | | | |
| Atleon 120 from 2004 Cabstar 28.11 35.13 35.1 | - Posteriore/Rear - Larghezza/Width mm. 109,60 - Altezza/Height mm. 50 - Spessore/Thickness mm. 20 | WVA 24589 D4060MA000 | 960459 |
| | |  | |
| Connessione / Connected:  960460-960458-960522 | | | |

EMMERRE

spare parts for trucks and trailers

NISSAN

SERIE PASTIGLIE FRENO
BRAKE PADS
JEU DE PLAQUETTES DE FREIN
SATZ BREMSBELÄGE
ТОРМОЗНЫЕ НАКЛАДКИ
JUEGO DE PASTILLAS DE FRENO

| Emmerre | Adattabile a / Adaptable to | Dettagli / Detail | Applicazioni / Applications |
|--|---|--|--|
| 960787 | WVA 29327 D1060MB20C 41060MB225 41060MB625 | - Anteriore/Front - Larghezza/Width mm. 164,50 - Altezza/Height mm. 67,80 - Spessore/Thickness mm. 20 | Cabstar 45.13 45.15 |
| Connessione / Connected:  960462-960522 | | | |
| 960786 | WVA 29260 D4060MB40A | - Posteriore/Rear - Larghezza/Width mm. 164,70 - Altezza/Height mm. 66,30 - Spessore/Thickness mm. 20,30 | Cabstar 45.13 45.15 |
| Connessione / Connected:  960058 | | | |
| 960947E3 | WVA 29039 WVA 29302 -06902964-0 | - Anteriore e posteriore/Front and Rear - Larghezza/Width mm. 175 - Altezza/Height mm. 78 - Spessore/Thickness mm. 22 Omologazione/Homologation Nr.: <u>E3 90R-01107/001</u> | Atleon 140 L.T. Atleon 160 Atleon 165 Atleon 210 from 09/99 Atleon TK Eco L60 Eco L70 Eco T135 Eco T160 |
| Connessione / Connected:  960054-960062-960235-960236-960526-960527 | | | |



SERIE PASTIGLIE FRENO
BRAKE PADS
JEU DE PLAQUETTES DE FREIN
SATZ BREMSBELAEGE
ТОРМОЗНЫЕ НАКЛАДКИ
JUEGO DE PASTILLAS DE FRENO

EMMERRE
spare parts for trucks and trailers

RENAULT

| Applicazioni / Applications | Dettagli / Detail | Adattabile a / Adaptable to | Emmerre |
|-----------------------------|---|---|---------------|
| Master from 11/97 | <ul style="list-style-type: none"> - Anteriore/Front - Larghezza/Width mm. 139 - Altezza/Height mm. 68 - Spessore/Thickness mm. 18 | WVA 23302 7701207166 7701205294 7701206369 | 960986 |



| | |
|--------------------------|--|
| Connessione / Connected: |  960234 |
|--------------------------|--|

| | | | |
|--|--|-------------------------|-----------------|
| Master from 11/97 Master II from 10/2003 | <ul style="list-style-type: none"> - Anteriore/Front - Larghezza/Width mm. 138,80 - Altezza/Height mm. 79,70 - Spessore/Thickness mm. 17,60 | WVA 23613 7701207339 | 960988E3 |
|--|--|-------------------------|-----------------|

Omologazione/Homologation Nr.:
E3 90R-01135/001



| | |
|--------------------------|--|
| Connessione / Connected: |  960233 |
|--------------------------|--|

| | | | |
|--|--|-------------------------|-----------------|
| Master from 11/97 Master II from 10/2003 | <ul style="list-style-type: none"> - Posteriore/Rear - Larghezza/Width mm. 115,80 - Altezza/Height mm. 51,30 - Spessore/Thickness mm. 16,80 | WVA 23669 7701206763 | 960985E3 |
|--|--|-------------------------|-----------------|

Omologazione/Homologation Nr.:
E3 90R-01136/001



| | |
|--------------------------|--|
| Connessione / Connected: |  960231 |
|--------------------------|--|

I riferimenti indicati non sono originali ma perfettamente intercambiabili. I codici originali e le case costruttrici sono indicati a puro titolo informativo
The details described are not original but perfectly interchangeable. The original references and manufacturer names are given for information purposes only.

EMMERRE

spare parts for trucks and trailers

RENAULT

SERIE PASTIGLIE FRENO
BRAKE PADS
JEU DE PLAQUETTES DE FREIN
SATZ BREMSBELÄGE
ТОРМОЗНЫЕ НАКЛАДКИ
JUEGO DE PASTILLAS DE FRENO

| Emmerre | Adattabile a / Adaptable to | Dettagli / Detail | Applicazioni / Applications |
|---|--|--|-----------------------------|
| 960791  | WVA 25112 7485133241 440601147R 7485146820 | - Posteriore/Rear - Larghezza/Width mm. 128,60 - Altezza/Height mm. 59,80 - Spessore/Thickness mm. 17,50 - Pistone pinza freni/ Brake caliper piston Ø 48 mm - Ruota singola/single wheel | Master III |
| Connessione / Connected:  960473 | | | |
| 960789  | WVA 25147 WVA 25148 7485121748 410604386R | - Anteriore/Front - Larghezza/Width mm. 163,50 - Altezza/Height mm. 64,70 - Spessore/Thickness mm. 17,40 | Master III |
| Connessione / Connected:  960192 | | | |
| 960790  | WVA 25172 440600941R WVA 25173 440600866R 7485133244 7485147733 | - Posteriore/Rear - Larghezza/Width mm. 163,70 - Altezza/Height mm. 62,80 - Spessore/Thickness mm. 17,40 - Pistone pinza freni/ Brake caliper piston Ø 60 mm - Ruote gemelle/Twins wheels | Master III |
| Connessione / Connected:  960472 | | | |

SERIE PASTIGLIE FRENO
BRAKE PADS
JEU DE PLAQUETTES DE FREIN
SATZ BREMSBELAEGE
ТОРМОЗНЫЕ НАКЛАДКИ
JUEGO DE PASTILLAS DE FRENO

EMMERRE
spare parts for trucks and trailers

RENAULT

| Applicazioni / Applications | Dettagli / Detail | Adattabile a / Adaptable to | Emmerre |
|--|--|--|---------------|
| Maxity from 2,8 to 3,5 ton | <ul style="list-style-type: none"> - Anteriore/Front - Larghezza/Width mm. 163,10 - Altezza/Height mm. 66,70 - Spessore/Thickness mm. 20,80 | WVA 29229 WVA 29230 7485116333 5001868606 | 960461 |
| Connessione / Connected:  960462 | | | |
| Maxity from 2,8 to 3,5 ton | <ul style="list-style-type: none"> - Posteriore/Rear - Larghezza/Width mm. 109,60 - Altezza/Height mm. 50 - Spessore/Thickness mm. 20 | WVA 24589 5001868608 | 960459 |
| Connessione / Connected:  960458-960460 | | | |
| Maxity 4,5 ton 130.45 150.45 | <ul style="list-style-type: none"> - Anteriore/Front - Larghezza/Width mm. 164,50 - Altezza/Height mm. 67,80 - Spessore/Thickness mm. 20 | WVA 29327 7485120221 5001874888 | 960787 |
| Connessione / Connected:  960462-960522 | | | |



EMMERRE

spare parts for trucks and trailers

RENAULT

SERIE PASTIGLIE FRENO
BRAKE PADS
JEU DE PLAQUETTES DE FREIN
SATZ BREMSBELAEGE
ТОРМОЗНЫЕ НАКЛАДКИ
JUEGO DE PASTILLAS DE FRENO

| Emmerre | Adattabile a / Adaptable to | Dettagli / Detail | Applicazioni / Applications |
|--|---|--|------------------------------------|
| 960786  | WVA 29260 5001868609 | - Posteriore/Rear - Larghezza/Width mm. 164,70 - Altezza/Height mm. 66,30 - Spessore/Thickness mm. 20,30 | Maxity 4,5 ton 130.45 150.45 |
| Connessione / Connected:  960058 | | | |
| 960987E3  | WVA 29260 WVA 29121 WVA 29374 5001850859 5001844747 | - Anteriore e posteriore/Front and Rear - Larghezza/Width mm. 164,80 - Altezza/Height mm. 66,50 - Spessore/Thickness mm. 20 Omologazione/Homologation Nr.: <u>E3 90R-01103/001 EST02</u> | Mascott |
| Connessione / Connected:  960229-960230-960392-960209-960198  960819 | | | |
| 960972E3  | WVA 29160 5001844748 | - Anteriore e posteriore/Front and Rear - Larghezza/Width mm. 164,50 - Altezza/Height mm. 67,80 - Spessore/Thickness mm. 20 Omologazione/Homologation Nr.: <u>E3 90R-01102/001</u> | Mascott |
| Connessione / Connected:  960209-960229-960230-960392  960819 | | | |

SERIE PASTIGLIE FRENO
BRAKE PADS
JEU DE PLAQUETTES DE FREIN
SATZ BREMSBELAEGE
ТОРМОЗНЫЕ НАКЛАДКИ
JUEGO DE PASTILLAS DE FRENO

EMMERRE
spare parts for trucks and trailers

RENAULT

| Applicazioni / Applications | Dettagli / Detail | Adattabile a / Adaptable to | Emmerre |
|--|--|--|-----------------|
| Midliner 93 Messenger Bus | <ul style="list-style-type: none"> - Anteriore/Front - Larghezza/Width mm. 166,60 - Altezza/Height mm. 62 - Spessore/Thickness mm. 17 <p>Omologazione/Homologation Nr.: E3 90R-01123/001</p> | WVA 29706 WVA 29947 5000295329 5001842048 7701203917 7701203895 | 960959E3 |
|  | | | |
| Connessione / Connected:  960305-960342  960919 | | | |
| Midliner | <ul style="list-style-type: none"> - Anteriore e posteriore/Front and Rear - Larghezza/Width mm. 176 - Altezza/Height mm. 78 - Spessore/Thickness mm. 22 <p>Omologazione/Homologation Nr.: E3 90R-01107/001</p> | WVA 29067 5001825339 5001825639 5001014704 | 960939E3 |
|  | | | |
| Connessione / Connected:  960199-960227-960228-960237-960238-960239-960242  960918 | | | |
| Midliner | <ul style="list-style-type: none"> - Anteriore/Front - Larghezza/Width mm. 214 - Altezza/Height mm. 112 - Spessore/Thickness mm. 25 | WVA 29099 WVA 29100 5001857615 5001833104 | 960991 |
|  | | | |
| Connessione / Connected:  960228  960977 | | | |

EMMERRE

spare parts for trucks and trailers

RENAULT

SERIE PASTIGLIE FRENO
BRAKE PADS
JEU DE PLAQUETTES DE FREIN
SATZ BREMSBELÄGE
ТОРМОЗНЫЕ НАКЛАДКИ
JUEGO DE PASTILLAS DE FRENO

| Emmerre | Adattabile a / Adaptable to | Dettagli / Detail | Applicazioni / Applications |
|--|--|--|--|
| 960823 | WVA 29181 WVA 29147 WVA 29207 5001866914 5010598372 | - Anteriore e posteriore/ Front and Rear - Larghezza/Width mm. 210,50 - Altezza/Height mm. 93,50 - Spessore/Thickness mm. 30 | Midlum |
|  | | | |
| Connessione / Connected:  960482-960240-960481-960193-960197 | | | |
| 960969E3 | WVA 29088 WVA 29091 7485137861 5010848607 5001866951 | - Anteriore e posteriore/ Front and Rear - Larghezza/Width mm. 175,50 - Altezza/Height mm. 85,60 - Spessore/Thickness mm. 26 Omologazione/Homologation Nr.: E3 90R-01116/001 EST02 | Midlum |
|  | | | |
| Connessione / Connected:  960237-960238-960239-960240-960242-960197  960806-960440 | | | |
| 960270 | WVA 29173 WVA 29203 7421399915 5001864365 7421496556 MDP 5102 | - Anteriore e posteriore/ Front and Rear - Larghezza/Width mm. 216,20 - Altezza/Height mm. 97 - Spessore/Thickness mm. 29,20 | Midlum Magnum DXi12 Magnum DXi13 |
|  | | | |
| Connessione / Connected:  960237-960238-960239-960240-960242-960475  960806-960440 | | | |

SERIE PASTIGLIE FRENO
BRAKE PADS
JEU DE PLAQUETTES DE FREIN
SATZ BREMSBELAEGE
ТОРМОЗНЫЕ НАКЛАДКИ
JUEGO DE PASTILLAS DE FRENO

EMMERRE
spare parts for trucks and trailers

RENAULT

| Applicazioni / Applications | Dettagli / Detail | Adattabile a / Adaptable to | Emmerre |
|---|---|---|-----------------|
| Midlum | <ul style="list-style-type: none"> - Anteriore e posteriore / Front and Rear - Larghezza / Width mm. 204,60 - Altezza / Height mm. 99,60 - Spessore / Thickness mm. 30 <p>Omologazione / Homologation Nr.: E3 90R-01139/001</p> | WVA 29142 WVA 29119 WVA 29141 7485137789 5001855902 | 960272E3 |
|  | | | |
| Connessione / Connected:  960237-960238-960239-960240-960242  960806-960440 | | | |
| R340 R350 R380 R385 R420 | <ul style="list-style-type: none"> - Anteriore / Front - Larghezza / Width mm. 204 - Altezza / Height mm. 97 - Spessore / Thickness mm. 24 | WVA 29043 5001822987 5000294357 5000821964 5000525640 5000294537 MDP 5008 | 960958 |
|  | | | |
| Connessione / Connected:  960306  960917 | | | |
| Series R Mldliner | <ul style="list-style-type: none"> - Anteriore / Front - Larghezza / Width mm. 169,70 - Altezza / Height mm. 97 - Spessore / Thickness mm. 18,80 | WVA 29072 5001821995 5010104739 5001834448 5010207049 5010151214 | 961049 |
|  | | | |
| Connessione / Connected:  960308 | | | |

EMMERRE

spare parts for trucks and trailers

RENAULT

SERIE PASTIGLIE FRENO
BRAKE PADS
JEU DE PLAQUETTES DE FREIN
SATZ BREMSBELAEGE
ТОРМОЗНЫЕ НАКЛАДКИ
JUEGO DE PASTILLAS DE FRENO

| Emmerre | Adattabile a / Adaptable to | | Dettagli / Detail | Applicazioni / Applications |
|--|---|--|--|---|
| 960956E1 960956E3 | WVA 29030 WVA 29083 WVA 29084 5001848363 | 5001823000 5001833124 5001854341 5001854342 5001834075 | - Anteriore e posteriore / Front and Rear - Larghezza / Width mm. 250 - Altezza / Height mm. 118 - Spessore / Thickness mm. 28 Omologazione / Homologation Nr.: E1 90R-011363/005 E3 90R-01113/001 | Magnum Premium Distribution Premium Route |
|  | | | | |
| Connessione / Connected:  960307  960814-960933 | | | | |
| 960982E3 | WVA 29090 5001846034 5001833114 MDP5042 | | - Anteriore / Front - Larghezza / Width mm. 250 - Altezza / Height mm. 114 - Spessore / Thickness mm. 28 - Con molle / With springs Omologazione / Homologation Nr.: E3 90R-01118/001 | Magnum Premium Distribution Premium Route |
|  | | | | |
| Connessione / Connected:  960307  960977 | | | | |
| 960983E3 | WVA 29131 WVA 29156 5001855646 | 5001020312 MDP5056 5001863904 | - Anteriore e posteriore / Front and Rear - Larghezza / Width mm. 250 - Altezza / Height mm. 118 - Spessore / Thickness mm. 30 Omologazione / Homologation Nr.: E3 90R-01119/001 EST02 | Magnum Magnum E-tech Premium Distribution Premium Route |
|  | | | | |
| Connessione / Connected:  960226-960464-960500  960434-960804-960814 | | | | |

SERIE PASTIGLIE FRENO
BRAKE PADS
JEU DE PLAQUETTES DE FREIN
SATZ BREMSBELAEGE
ТОРМОЗНЫЕ НАКЛАДКИ
JUEGO DE PASTILLAS DE FRENO

EMMERRE
spare parts for trucks and trailers

RENAULT

| Applicazioni / Applications | Dettagli / Detail | Adattabile a / Adaptable to | Emmerre |
|--|--|--|--|
| Magnum DXI 12 Magnum DXI 13 Premium Distribution II Premium Route II | <ul style="list-style-type: none"> - Anteriore e posteriore/<i>Front and Rear</i> - Larghezza/<i>Width</i> mm. 249,30 - Altezza/<i>Height</i> mm. 109,70 - Spessore/<i>Thickness</i> mm. 29,30 <p>Omologazione/Homologation Nr.: E1 90R-011363/017 E3 90R-01137/001</p> | <p>WVA 29174 WVA 29204 5001864363 5001864364 7421496555 7421399929</p> | <p>960989E1 960989E3</p> |
|  | | | |
| <p>Connessione / Connected:  960225  960434</p> | | | |
| Magnum DXI 12 Magnum DXI 13 Premium Distribution II Premium Route II | <ul style="list-style-type: none"> - Anteriore e posteriore/<i>Front and Rear</i> - Larghezza/<i>Width</i> mm. 210,60 - Altezza/<i>Height</i> mm. 99,90 - Spessore/<i>Thickness</i> mm. 29,20 <p>Omologazione/Homologation Nr.: E3 90R-01141/001</p> | <p>WVA 29177 WVA 29169 7421496557 5001864380</p> | <p>960394E3</p> |
|  | | | |
| <p>Connessione / Connected:  960225  960804</p> | | | |
| Midlum | <ul style="list-style-type: none"> - Anteriore e posteriore/<i>Front and Rear</i> - Larghezza/<i>Width</i> mm. 175,50 - Altezza/<i>Height</i> mm. 85,60 - Spessore/<i>Thickness</i> mm. 26 - Con indicatori di usura e kit fissaggio/ With wear indicators and fixed kit <p>Omologazione/Homologation Nr.: E3 90R-01116/001 EST02</p> | <p>WVA 29088 5010848607 5001866951</p> | <p>961041</p> |
|  | | | |
| <p>Connessione / Connected:  960237-960238-960239-960240-960242  960806-960440</p> | | | |

| Emmerre | Adattabile a / Adaptable to | Dettagli / Detail | Applicazioni / Applications | |
|---|-----------------------------|-------------------|--|-----|
| 960928E3 | WVA 29124 | 15224835T400 | - Larghezza/Width mm. 205,50 - Altezza/Height mm. 102 - Spessore/Thickness mm. 27 - Con molle/With springs - Con kit accessori/With kit accessories Omologazione/Homologation Nr.: E3 90R-01112/001 | LM |
| | WVA 29155 | 3222-X-2156 | | LMC |
| | MDP5076 | 3222X2156 | | TM |
| | MDP3124 | | | |
|  | | | | |
| Connessione / Connected:  960110-960301-960119  960525-960530-960531-960532 | | | | |
| 960394E3 | WVA 29169 | | - Larghezza/Width mm. 210,60 - Altezza/Height mm. 99,90 - Spessore/Thickness mm. 29,20 - Con molle/With springs - Con kit accessori/With accessories kit Omologazione/Homologation Nr.: E3 90R-01141/001 | LM |
| | WVA 29177 | | | LMC |
| | 68324665 | | | TAC |
| | MDP5093 | | | TM |
| | MDP5103 | | | |
| | MDP5100 | | | |
|  | | | | |
| Connessione / Connected:  960417-960350-960351  960525 | | | | |
| 970007E3 | WVA 29131 | | - Larghezza/Width mm. 250 - Altezza/Height mm. 118 - Spessore/Thickness mm. 30 Omologazione/Homologation Nr.: E3 90R-01119/001 EST02 | LMC |
| | MDP5073 | | | TA |
| | MDP5059 | | | TAC |
| | MDP5060 | | | TM |
| | MDP5097 | | | |
|  | | | | |
| Connessione / Connected:  960300 | | | | |

SERIE PASTIGLIE FRENO
BRAKE PADS
JEU DE PLAQUETTES DE FREIN
SATZ BREMSBELAEGE
ТОРМОЗНЫЕ НАКЛАДКИ
JUEGO DE PASTILLAS DE FRENO

EMMERRE
spare parts for trucks and trailers

ROR

| Applicazioni / Applications | Dettagli / Detail | Adattabile a / Adaptable to | Emmerre |
|-----------------------------|---|---|---------------|
| LM LMC | - Posteriore/Rear - Larghezza/Width mm. 216 - Altezza/Height mm. 110,75 - Spessore/Thickness mm. 29 | WVA 29211 WVA 29291 MDP5117 68326055 | 960788 |



| Connessione / Connected: | 960300 | | |
|------------------------------------|---|---------------------------------|-----------------|
| LM LMC TA TAC TC TM | - Anteriore e posteriore/Front and Rear - Larghezza/Width mm. 249 - Altezza/Height mm. 111,20 - Spessore/Thickness mm. 29 Omologazione/Homologation Nr.: E3 90R-01120/001 | WVA 29125 MDP5057 MDP1388 | 960993E3 |



| Connessione / Connected: | 960300 | | | |
|--------------------------|--|--|--|------------------------------------|
| Meritor Elsa 1/03 | - Larghezza/Width mm. 250 - Altezza/Height mm. 118 - Spessore/Thickness mm. 28 Omologazione/Homologation Nr.: E1 90R-011363/005 E3 90R-01113/001 | WVA 29113 WVA 29030 WVA 29084 MDP5033 | MDP5038 MDP5054 MDP5041 MDP5091 | 960956E1 960956E3 |



| Emmerre | Adattabile a / Adaptable to | Dettagli / Detail | Applicazioni / Applications |
|--|------------------------------------|---|-----------------------------|
| 960948E3 | WVA 29095 3057007800 | <ul style="list-style-type: none"> - Larghezza/Width mm. 211 - Altezza/Height mm. 92,50 - Spessore/Thickness mm. 30 - Con molle/With springs - Con kit accessori/With accessories kit - Con piastre/With plates | Trailer SK |
| | WVA 29093 5317002400 | | |
| | WVA 29145 4057427800 | | |
| | WVA 29184 37779813840 | | |
| | WVA 29197 | | |
|  | | <p>Omologazione/Homologation Nr.: E3 90R-01110/001 EST02</p> | |
| <p>Connessione / Connected:  960298-960371  960523</p> | | | |
| 960999E3 | WVA 29126 | <ul style="list-style-type: none"> - Larghezza/Width mm. 210,60 - Altezza/Height mm. 92,30 - Spessore/Thickness mm. 29,80 - Con molle/With springs - Con kit accessori/With accessories kit | Trailer SK |
| | WVA 29159 | | |
| | 3057008000 | | |
| | 3057008001 | | |
| | | | |
|  | | <p>Omologazione/Homologation Nr.: E3 90R-01131/001</p> | |
| <p>Connessione / Connected:  960298-960371-960395-960467  960523</p> | | | |
| 960944E1 960944E3 | WVA 29253 3057007700 | <ul style="list-style-type: none"> - Larghezza/Width mm. 247,20 - Altezza/Height mm. 109,70 - Spessore/Thickness mm. 30 - Con molle/With springs - Con kit accessori/With accessories kit - Con piastre/With plates | Trailer SK |
| | WVA 29087 3057007900 | | |
| | WVA 29105 3057007701 5317002300 | | |
|  | | <p>Omologazione/Homologation Nr.: E1 90R-011363/008 E3 90R-01101/001 EST03</p> | |
| <p>Connessione / Connected:  960353-960362  960523-960524</p> | | | |

**SERIE PASTIGLIE FRENO
BRAKE PADS
JEU DE PLAQUETTES DE FREIN
SATZ BREMSBELAEGE
ТОРМОЗНЫЕ НАКЛАДКИ
JUEGO DE PASTILLAS DE FRENO**

EMMERRE
spare parts for trucks and trailers

SAF

| Applicazioni / Applications | Dettagli / Detail | Adattabile a / Adaptable to | Emmerre |
|---|---|--|-----------------|
| Trailer SKRB SKRLB SKRS SK SKRZ | - Larghezza/Width mm. 247,60 - Altezza/Height mm. 105 - Spessore/Thickness mm. 30 - Con molle/With springs - Con kit accessori/With accessories kit | WVA 29143 WVA 29185 WVA 29176 3057317900 MDP1406 | 960949E3 |

Omologazione/Homologation Nr.:
E3 90R-01138/001 EST01



| Connessione / Connected: | 960353-960362 | 960523-960524 |
|--------------------------|---------------|---------------|
|--------------------------|---------------|---------------|

| | | | |
|-----------------------|---|---|-----------------|
| SKRLB SKRS SKRZ | - Larghezza/Width mm. 210,60 - Altezza/Height mm. 109,55 - Spessore/Thickness mm. 31,70 - Con molle/With springs - Con kit accessori/With accessories kit | WVA 29162 3057008400 3057008401 0233501309 | 960102E3 |
|-----------------------|---|---|-----------------|

Omologazione/Homologation Nr.:
E3 90R-01140/001 EST01



| Connessione / Connected: | 960395-960396-960468-960469 |
|--------------------------|-----------------------------|
|--------------------------|-----------------------------|

| | | | |
|--|---|--|---------------|
| SKRZ 11222 SKRZ 9022 SKRB 9022 (Inte- gral) SKRS 1222K SKRS 9022K | - Larghezza/Width mm. 210,60 - Altezza/Height mm. 108 - Spessore/Thickness mm. 30 - Con molle/With springs | WVA 29194 WVA 29158 3057008500 3057008501 | 960891 |
|--|---|--|---------------|

Omologazione/Homologation Nr.:
E3 90R-01134/001 EST02



| Connessione / Connected: | 960395-960396-960468-960469 |
|--------------------------|-----------------------------|
|--------------------------|-----------------------------|

I riferimenti indicati non sono originali ma perfettamente intercambiabili. I codici originali e le case costruttrici sono indicati a puro titolo informativo
The details described are not original but perfectly interchangeable. The original references and manufacturer names are given for information purposes only.

| Emmerre | Adattabile a / Adaptable to | Dettagli / Detail | Applicazioni / Applications |
|--|--------------------------------------|--|---|
| 960794E3  <p>EMMERRE MODIFICATION</p> | WVA 29252 3057007700 | <ul style="list-style-type: none"> - Larghezza/Width mm. 248 - Altezza/Height mm. 109,50 - Spessore/Thickness mm. 30 - Con molle/With springs - Con kit accessori/With accessories kit - Con piastre/With plates - Nostro Brevetto/Our patent <p>Omologazione/Homologation Nr.: E3 90R-02A0794/4091</p> <p>PATENT PENDING</p> | Axle SKRZ 9022 SKRB 9022 (SN7) Integral SKRLB 9022 (SN7) Integral |
| Connessione / Connected: | | |  960395-960396 |
| 961070E3  <p>NEWS</p> <p>EMMERRE MODIFICATION</p> | WVA 29318 WVA 29319 3057000600 | <ul style="list-style-type: none"> - Larghezza/Width mm. 214,70 - Altezza/Height mm. 107 - Spessore/Thickness mm. 34,50 - Con molle/With springs - Con piastre/With plates - Con kit accessori/With accessories kit - Nostro Brevetto/Our patent <p>PATENT PENDING</p> | Axle |
| Connessione / Connected: | | |  960396 |

SERIE PASTIGLIE FRENO
BRAKE PADS
JEU DE PLAQUETTES DE FREIN
SATZ BREMSBELAEGE
ТОРМОЗНЫЕ НАКЛАДКИ
JUEGO DE PASTILLAS DE FRENO

EMMERRE
spare parts for trucks and trailers

SCANIA

| Applicazioni / Applications | Dettagli / Detail | Adattabile a / Adaptable to | | Emmerre |
|-----------------------------|---|-----------------------------|---------|-----------------|
| 94 | <ul style="list-style-type: none"> - Anteriore e posteriore/<i>Front and Rear</i> - Larghezza/<i>Width</i> mm. 247,20 - Altezza/<i>Height</i> mm. 109,70 - Spessore/<i>Thickness</i> mm. 30 - Con molle/<i>With springs</i> - Con kit accessori/<i>With accessories kit</i> - Con piastre/<i>With plates</i> <p>Omologazione/Homologation Nr.: E1 90R-011363/008 E3 90R-01101/001 EST03</p> | WVA 29253 | 1734529 | 960944E1 |
| 114 | | WVA 29087 | 1856108 | |
| 124 | | WVA 29105 | 1914100 | |
| 144 | | 1390428 | | |
| 164 | | | | |



Connessione / Connected:  960052  960523-960838-960975

| Emmerre | Adattabile a / Adaptable to | Dettagli / Detail | Applicazioni / Applications |
|---|---|--|-----------------------------|
| 960944E1 960944E3 | WVA 29087 WVA 29105 WVA 29108 WVA 29059 WVA 29061 | <ul style="list-style-type: none"> - Larghezza/Width mm. 247,20 - Altezza/Height mm. 109,70 - Spessore/Thickness mm. 30 - Con molle/With springs - Con kit accessori/With kit accessories - Senza piastra/Without plates <p>Omologazione/Homologation Nr.: E1 90R-011363/008 E3 90R-01101/001 EST03</p> | Cargo Bull Trailer |
| | | | |
| | | Connessione / Connected: 960018 960523 | |
| 960891 | WVA 29194 WVA 29158 1008452 1105625 1161593 | <ul style="list-style-type: none"> - Posteriore/Rear - Larghezza/Width mm. 210,60 - Altezza/Height mm. 108 - Spessore/Thickness mm. 30 - Con molle/With springs <p>Omologazione/Homologation Nr.: E3 90R-01134/001 EST02</p> | Cargo Bull Trailer |
| | | | |
| | | Connessione / Connected: 960018 | |
| 961071E3 | WVA 29329 1178243 | <ul style="list-style-type: none"> - Larghezza/Width mm. 214,70 - Altezza/Height mm. 107 - Spessore/Thickness mm. 34,50 - Con molle/With springs - Con piastra/With plates - Con kit accessori/With accessories kit - Nostro Brevetto/Our patent | Axle |
| | | | |
| <div style="display: flex; justify-content: space-between; align-items: center;"> <div style="border: 2px solid red; border-radius: 50%; padding: 5px; color: white; font-weight: bold;">NEWS</div> <div style="border: 2px solid red; border-radius: 50%; padding: 5px; color: white; font-weight: bold; transform: rotate(-15deg);">EMMERRE MODIFICATION</div> <div style="border: 2px solid red; padding: 5px; color: white; font-weight: bold; text-align: center;">PATENT PENDING</div> </div> | | | |

**SERIE PASTIGLIE FRENO
BRAKE PADS
JEU DE PLAQUETTES DE FREIN
SATZ BREMSBELAEGE
ТОРМОЗНЫЕ НАКЛАДКИ
JUEGO DE PASTILLAS DE FRENO**

EMMERRE
spare parts for trucks and trailers

SMB

| Applicazioni / Applications | Dettagli / Detail | Adattabile a / Adaptable to | Emmerre |
|-----------------------------|--|--|-----------------|
| Trailer SMB | <ul style="list-style-type: none"> - Larghezza/Width mm. 211 - Altezza/Height mm. 92,50 - Spessore/Thickness mm. 30 - Con molle/With springs - Con kit accessori/With kit accessories - Con piastre/With plates <p>Omologazione/Homologation Nr.: E3 90R-01110/001 EST02</p> | WVA 29095 WVA 29145 WVA 29184 WVA 29197 449412 | 960948E3 |



| Connessione / Connected:  960364  960523 | | | |
|--|---|--|------------------------------------|
| Trailer SMB | <ul style="list-style-type: none"> - Larghezza/Width mm. 247,20 - Altezza/Height mm. 109,70 - Spessore/Thickness mm. 30 - Con molle/With springs - Con kit accessori/With kit accessories - Con piastre/With plates <p>Omologazione/Homologation Nr.: E1 90R-011363/008 E3 90R-01101/001 EST03</p> | WVA 29253 WVA 29087 WVA 29105 WVA 29108 M100669 M91004501 | 960944E1 960944E3 |



| Connessione / Connected:  960363  960523 | | | |
|--|--|--|-----------------|
| Trailer SMB | <ul style="list-style-type: none"> - Larghezza/Width mm. 247,60 - Altezza/Height mm. 105 - Spessore/Thickness mm. 30 - Con molle/With springs - Con kit accessori/With kit accessories <p>Omologazione/Homologation Nr.: E3 90R-01138/001 EST01</p> | WVA 29143 WVA 29185 WVA 29176 M91002704 | 960949E3 |



EMMERRE

spare parts for trucks and trailers

VOLVO

SERIE PASTIGLIE FRENO BRAKE PADS JEU DE PLAQUETTES DE FREIN SATZ BREMSBELAEGE ТОРМОЗНЫЕ НАКЛАДКИ JUEGO DE PASTILLAS DE FRENO

| Emmerre | Adattabile a / Adaptable to | Dettagli / Detail | Applicazioni / Applications |
|---|--|---|------------------------------|
| 960927E3 | WVA 29039 WVA 29302 2761476 6779998 MDP5030 | - Anteriore e posteriore/ Front and Rear - Larghezza/Width mm. 175,50 - Altezza/Height mm. 78 - Spessore/Thickness mm. 21 Omologazione/Homologation Nr.: E3 90R-01107/001 | FL 6 |
|  | | | |
| Connessione / Connected:  960310-960311-960312-960387-960388-960417  960978 | | | |
| 960963E3 | WVA 29039 WVA 29302 WVA 21302 3090048 MDP5429 3090784 6779998 MDP5761 MDP702 | - Anteriore e posteriore/ Front and Rear - Larghezza/Width mm. 175,50 - Altezza/Height mm. 77 - Spessore/Thickness mm. 21 Omologazione/Homologation Nr.: E3 90R-01107/001 | FL 6 FL 7 FL 10 FLC |
|  | | | |
| Connessione / Connected:  960310-960311-960312-960387-960388-960417  960978 | | | |
| 960430 | WVA 29136 3093531 MDP5052 | - Anteriore/Front - Larghezza/Width mm. 175,70 - Altezza/Height mm. 89,10 - Spessore/Thickness mm. 29,20 | FL |
|  | | | |
| Connessione / Connected:  960474-960417 | | | |

SERIE PASTIGLIE FRENO
BRAKE PADS
JEU DE PLAQUETTES DE FREIN
SATZ BREMSBELAEGE
ТОРМОЗНЫЕ НАКЛАДКИ
JUEGO DE PASTILLAS DE FRENO

EMMERRE
spare parts for trucks and trailers

VOLVO

| Applicazioni / Applications | Dettagli / Detail | Adattabile a / Adaptable to | Emmerre |
|---|---|--|-----------------|
| FL | <ul style="list-style-type: none"> - Anteriore e posteriore/<i>Front and Rear</i> - Larghezza/<i>Width</i> mm. 210,10 - Altezza/<i>Height</i> mm. 102,40 - Spessore/<i>Thickness</i> mm. 29,20 | WVA 29137 3093532 20768115 MDP5053 | 960347 |
|  | | | |
| Connessione / Connected:  960417-960424-960444-960683  960523 | | | |
| FL 6 FH FH 16 | <ul style="list-style-type: none"> - Anteriore e posteriore/<i>Front and Rear</i> - Larghezza/<i>Width</i> mm. 210,60 - Altezza/<i>Height</i> mm. 99,90 - Spessore/<i>Thickness</i> mm. 30 <p><u>Omologazione/Homologation Nr.:</u> <u>E3 90R-01141/001</u></p> | WVA 29169 WVA 29177 20568713 20765963 63834665 21496552 | 960394E3 |
|  | | | |
| Connessione / Connected:  960407-960218-960463-960486  960525 | | | |
| FL6 | <ul style="list-style-type: none"> - Anteriore e posteriore/<i>Front and Rear</i> - Larghezza/<i>Width</i> mm. 216,20 - Altezza/<i>Height</i> mm. 97 - Spessore/<i>Thickness</i> mm. 29,20 | WVA 29173 WVA 29203 20568712 20568715 21352573 | 960271 |
|  | | | |
| Connessione / Connected:  960218-960407-960486-960482-960193-960240-960463-960475  960525 | | | |

EMMERRE

spare parts for trucks and trailers

VOLVO

SERIE PASTIGLIE FRENO BRAKE PADS JEU DE PLAQUETTES DE FREIN SATZ BREMSBELAEGE ТОРМОЗНЫЕ НАКЛАДКИ JUEGO DE PASTILLAS DE FRENO

| Emmerre | Adattabile a / Adaptable to | Dettagli / Detail | Applicazioni / Applications |
|--|-----------------------------|--|-----------------------------|
| 960993E3 | WVA 29125 | - Anteriore e posteriore/ Front and Rear - Larghezza/Width mm. 249 - Altezza/Height mm. 111,20 - Spessore/Thickness mm. 29 | FH 12 |
| | WVA 29222 | | FH 16 |
| | 3095396 | | FL 6 |
| | 20918891 | | FM 9 |
| | 1078439 | | FM 12 |
| | 20768092 | | |
|  | | Omologazione/Homologation Nr.: E1 90R-011363/003 E3 90R-01120/001 | |
| Connessione / Connected:  960370-960374-960457-960456 | | | |
| 960349 | WVA 29151 | - Anteriore e posteriore/ Front and Rear - Larghezza/Width mm. 216,10 - Altezza/Height mm. 97 - Spessore/Thickness mm. 29,20 | FH 12 |
| | 3099533 | | FH 16 |
| | 20768101 | | FM 9 |
| | MDP5072 | | FM 12 |
|  | | | |
| Connessione / Connected:  960218-960370-960374-960456-960463-960486 | | | |
| 970006E3 970006E11 | WVA 29174 | - Anteriore e posteriore/ Front and Rear - Larghezza/Width mm. 249,30 - Altezza/Height mm. 109,70 - Spessore/Thickness mm. 29,30 | FH 12 |
| | WVA 29204 | | FH 16 |
| | 20568711 | | FL |
| | 20568714 | | FM |
| | MDP5104 | | |
| | 21024702 | | |
| | 21352570 | | |
| | 21496550 | | |
|  | | Omologazione/Homologation Nr.: E3 90R-01137/001 E11 90R-02A01080/42092 | |
| Connessione / Connected:  960370-960374-960456-960457 | | | |

SERIE PASTIGLIE FRENO
BRAKE PADS
JEU DE PLAQUETTES DE FREIN
SATZ BREMSBELAEGE
ТОРМОЗНЫЕ НАКЛАДКИ
JUEGO DE PASTILLAS DE FRENO

EMMERRE
spare parts for trucks and trailers

VOLVO

| Applicazioni / Applications | Dettagli / Detail | Adattabile a / Adaptable to | Emmerre |
|-----------------------------|--|---|---------------|
| FL II | <ul style="list-style-type: none"> - Anteriore e posteriore/<i>Front and Rear</i> - Larghezza/<i>Width</i> mm. 210,50 - Altezza/<i>Height</i> mm. 93,50 - Spessore/<i>Thickness</i> mm. 30 | WVA 29207 WVA 29181 WVA 29147 20844903 20780788 | 960823 |



| | |
|--------------------------|--|
| Connessione / Connected: |  960240 |
|--------------------------|--|

| | | | |
|-----------------|--|---|---------------|
| FL II FL III | <ul style="list-style-type: none"> - Anteriore e posteriore/<i>Front and Rear</i> - Larghezza/<i>Width</i> mm. 216,20 - Altezza/<i>Height</i> mm. 97 - Spessore/<i>Thickness</i> mm. 29,20 | WVA 29173 WVA 29203 20568712 21352573 20568715 20560414 MDP5102 | 960270 |
|-----------------|--|---|---------------|





| | |
|--------------------------|--|
| Connessione / Connected: |  960486-960218-960463 |
|--------------------------|--|

EMMERRE

spare parts for trucks and trailers

VOLVO BUS

SERIE PASTIGLIE FRENO
BRAKE PADS
JEU DE PLAQUETTES DE FREIN
SATZ BREMSBELAEGE
ТОРМОЗНЫЕ НАКЛАДКИ
JUEGO DE PASTILLAS DE FRENO

| Emmerre | Adattabile a / Adaptable to | | Dettagli / Detail | Applicazioni / Applications |
|--|-----------------------------|----------|--|-----------------------------|
| 960964E3 | WVA 29090 | 85105485 | - Anteriore/Front | B 10L |
| | 3093919 | 8550611 | - Larghezza/Width mm. 250 | B 12 |
| | 20825594 | MDP5061 | - Altezza/Height mm. 114 | |
| | | | - Spessore/Thickness mm. 28 | |
|  | | | Omologazione/Homologation Nr.: E3 90R-01118/001 | |
| Connessione / Connected:  | | | | 960977 |



CEPPI FRENO e RIVETTI

BRAKE LININGS AND RIVETS
GARNITURES DE FREIN ET RIVETS
BREMSKLOETZE UND NIETEN
ТОРМОЗНЫЕ НАКЛАДКИ И ЗАКЛЕПКИ
FORROS DE FRENO Y REMACHES

BRAKE PARTS MANUFACTURER
TECHNO
BRAKE by OVER

NEWS

| Emmerre | Descrizione/Description | Adattabile/Adaptable to | Pagina/Page |
|--------------|--|-------------------------|-------------|
| R6503 | RIBATTINO TUBOLARE IN RAME TESTA PIANA | -- | 518 |

**CEPPI FRENO E RIVETTI
BRAKE LININGS AND RIVETS
GARNITURES DE FREIN ET RIVETS
BREMSKLOETZE UND NIETEN
ТОРМОЗНЫЕ НАКЛАДКИ И ЗАКЛЕПКИ
FORROS DE FRENO Y REMACHES**

EMMERRE
spare parts for trucks and trailers



ASTRA

| Applicazioni / Applications | Dettagli / Detail | Adattabile a / Adaptable to | Emmerre |
|-----------------------------|---|-----------------------------|-----------------------------|
| BM 21 | <ul style="list-style-type: none"> - Qty set: 4 - Rivetti/Rivet: 6 x 20 T12 - Ø tamburo freno/brake drum mm.: 430 <p>- WVA 57117 (4 pcs.):</p> <ul style="list-style-type: none"> - Lunghezza/Length mm.: 420 - Altezza fascia/Height band mm.: 140 - Spessore/Thickness mm.: 13 - Fori/Holes: 28 <p>Senza rivetti/Without rivets</p> | WVA 57117 | AC1697 AC1697+10 |



| Connessione / Connected:  R6201 | | | |
|--|---|------------------------|---|
| BM 304 BM 305 | <ul style="list-style-type: none"> - Qty set: 8 - Rivetti/Rivet: 6,3 x 18 T12 - Ø tamburo freno/brake drum mm.: 419 <p>- WVA 19370 (4 pcs.):</p> <ul style="list-style-type: none"> - Lunghezza/Length mm.: 190 - Altezza fascia/Height band mm.: 219 - Spessore/Thickness mm.: 18,5/15 - Fori/Holes: 12 <p>- WVA 19369 (4 pcs.):</p> <ul style="list-style-type: none"> - Lunghezza/Length mm.: 192 - Altezza fascia/Height band mm.: 219 - Spessore/Thickness mm.: 18/10 - Fori/Holes: 12 <p>Senza rivetti/Without rivets</p> | WVA 19370 WVA 19369 | AS5004 AS5004+10 AS5004+20 |



| Connessione / Connected:  AC1680-AC1681  R6007 | | | |
|--|--|--|--|
| | | | |



I riferimenti indicati non sono originali ma perfettamente intercambiabili. I codici originali e le case costruttrici sono indicati a puro titolo informativo
The details described are not original but perfectly interchangeable. The original references and manufacturer names are given for information purposes only.

EMMERRE

spare parts for trucks and trailers

ASTRA

CEPPI FRENO E RIVETTI BRAKE LININGS AND RIVETS GARNITURES DE FREIN ET RIVETS BREMSKLOETZE UND NIETEN ТОРМОЗНЫЕ НАКЛАДКИ И ЗАКЛЕПКИ FORROS DE FRENO Y REMACHES

| Emmerre | Adattabile a / Adaptable to | Dettagli / Detail | Applicazioni / Applications |
|--|--|--|-----------------------------|
| AS5011 AS5011+10 AS5011+20 | WVA 19384 WVA 19385 2991906 2991903 2991907 2991904 2991908 2991905 | - Qty set: 8 - Rivetti/Rivet: 6,3 x 16 T12 - Ø tamburo freno/brake drum mm.: 381 - Anteriore-posteriore/Front-Rear - WVA 19384 (6 pcs.): - Lunghezza/Lenght mm.: 190 - Altezza fascia/Height band mm.: 178 - Spessore/Thickness mm.: 18/12 - Fori/Holes: 12 - WVA 19385 (2 pcs.): - Lunghezza/Lenght mm.: 190 - Altezza fascia/Height band mm.: 178 - Spessore/Thickness mm.: 18/12 - Fori/Holes: 14 | HD7 |
|  | | Rockwell system Senza rivetti/Without rivets | |
| Connessione / Connected:  R6006 | | | |

| | | | |
|--|--|--|-----|
| AS5026 AS5026+10 AS5026+20 | WVA 19556 WVA 19714 WVA 19715 1906407 1906408 1906409 | - Qty set: 8 - Rivetti/Rivet: 8 x 18 T16 - Ø tamburo freno/brake drum mm.: 410 - Anteriore/Front - Simplex - WVA 19556 (4 pcs.): - Lunghezza/Lenght mm.: 196 - Altezza fascia/Height band mm.: 180 - Spessore/Thickness mm.: 21/12 - Fori/Holes: 12 - WVA 19714 (2 pcs.): - Lunghezza/Lenght mm.: 196 - Altezza fascia/Height band mm.: 180 - Spessore/Thickness mm.: 22/14,3 - Fori/Holes: 14 - WVA 19715 (2 pcs.): - Lunghezza/Lenght mm.: 196 - Altezza fascia/Height band mm.: 180 - Spessore/Thickness mm.: 22/12 - Fori/Holes: 12 | HD8 |
|  | | Rockwell system Senza rivetti/Without rivets | |
| Connessione / Connected:  R6001 | | | |

CEPPI FRENO E RIVETTI
BRAKE LININGS AND RIVETS
GARNITURES DE FREIN ET RIVETS
BREMSKLOETZE UND NIETEN
ТОРМОЗНЫЕ НАКЛАДКИ И ЗАКЛЕПКИ
FORROS DE FRENO Y REMACHES

EMMERRE
 spare parts for trucks and trailers

ASTRA



| Applicazioni / Applications | Dettagli / Detail | Adattabile a / Adaptable to | Emmerre |
|-----------------------------|--|--|--|
| HD8 | <ul style="list-style-type: none"> - Qty set: 8 - Rivetti/Rivet: 8 x 18 T16 - Ø tamburo freno/brake drum mm.: 410 - Anteriore/Front - Simplex <p>- WVA 19100 (6 pcs.):</p> <ul style="list-style-type: none"> - Lunghezza/Length mm.: 204 - Altezza fascia/Height band mm.: 182 - Spessore/Thickness mm.: 21/16 - Fori/Holes: 12 <p>- WVA 19099 (2 pcs.):</p> <ul style="list-style-type: none"> - Lunghezza/Length mm.: 204 - Altezza fascia/Height band mm.: 182 - Spessore/Thickness mm.: 21/16 - Fori/Holes: 14 <p>Rockwell system Senza rivetti/Without rivets</p> | <p>WVA 19100 WVA 19099</p> <p>2992002 2991918</p> <p>2991919</p> <p>2992004 2991920</p> | <p>AS5031 AS5031+10 AS5031+20</p> |



| Connessione / Connected:  R6001 | |
|--|--|
| HD8 | <ul style="list-style-type: none"> - Qty set: 8 - Rivetti/Rivet: 8 x 18 T16 - Ø tamburo freno/brake drum mm.: 410 - Posteriore/Rear - Simplex <p>- WVA 19553 (4 pcs.):</p> <ul style="list-style-type: none"> - Lunghezza/Length mm.: 196 - Altezza fascia/Height band mm.: 200 - Spessore/Thickness mm.: 21/12,5 - Fori/Holes: 12 <p>- WVA 19716 (2 pcs.):</p> <ul style="list-style-type: none"> - Lunghezza/Length mm.: 196 - Altezza fascia/Height band mm.: 200 - Spessore/Thickness mm.: 22/14,5 - Fori/Holes: 14 <p>- WVA 19717 (2 pcs.):</p> <ul style="list-style-type: none"> - Lunghezza/Length mm.: 196 - Altezza fascia/Height band mm.: 200 - Spessore/Thickness mm.: 22/11,8 - Fori/Holes: 12 <p>Rockwell system Con rivetti/With rivets</p> |



Cepri Freno
 Brake Linings

| Emmerre | Adattabile a / Adaptable to | Dettagli / Detail | Applicazioni / Applications |
|----------------------------------|---|--|-----------------------------|
| AS5024 AS5024+10 AS5024+20 | WVA 19098 WVA 19091 2992005 2992006 2992007 | <p>- Qty set: 8 - Rivetti/Rivet: 8 x 18 T16 - Ø tamburo freno/brake drum mm.: 410 - Posteriore/Rear</p> <p>- WVA 19098 (6 pcs.): - Lunghezza/Length mm.: 204 - Altezza fascia/Height band mm.: 200 - Spessore/Thickness mm.: 21/16 - Fori/Holes: 12</p> <p>- WVA 19091 (2 pcs.): - Lunghezza/Length mm.: 204 - Altezza fascia/Height band mm.: 200 - Spessore/Thickness mm.: 21/16 - Fori/Holes: 14</p> <p>Perrot (Wabco) system Con rivetti/With rivets</p>  | HD8 |
| AS5071 AS5071+10 AS5071+20 | WVA 19110 WVA 19109 2992113 2992114 2992115 | <p>- Qty set: 8 - Rivetti/Rivet: 8 x 18 T16 - Ø tamburo freno/brake drum mm.: 410 - Anteriore/Front - Duplex</p> <p>- WVA 19110 (4 pcs.): - Lunghezza/Length mm.: 196 - Altezza fascia/Height band mm.: 180 - Spessore/Thickness mm.: 22/13 - Fori/Holes: 14</p> <p>- WVA 19109 (4 pcs.): - Lunghezza/Length mm.: 196 - Altezza fascia/Height band mm.: 180 - Spessore/Thickness mm.: 22/13 - Fori/Holes: 12</p> <p>Meritor system Con rivetti/With rivets</p>  | HD8E |

Connessione / Connected:



R6001

Connessione / Connected:



R6001

CEPPI FRENO E RIVETTI
BRAKE LININGS AND RIVETS
GARNITURES DE FREIN ET RIVETS
BREMSKLOETZE UND NIETEN
ТОРМОЗНЫЕ НАКЛАДКИ И ЗАКЛЕПКИ
FORROS DE FRENO Y REMACHES

EMMERRE
 spare parts for trucks and trailers

ASTRA

| Applicazioni / Applications | Dettagli / Detail | Adattabile a / Adaptable to | Emmerre |
|-----------------------------|--|---|---|
| HD8E | <ul style="list-style-type: none"> - Qty set: 8 - Rivetti/Rivet: 8 x 18 T16 - Ø tamburo freno/brake drum mm.: 410 - Posteriore/Rear - Duplex <ul style="list-style-type: none"> - WVA 19116 (4 pcs.): - Lunghezza/Lenght mm.: 196 - Altezza fascia/Height band mm.: 200 - Spessore/Thickness mm.: 22/13 - Fori/Holes: 12 <ul style="list-style-type: none"> - WVA 19119 (4 pcs.): - Lunghezza/Lenght mm.: 196 - Altezza fascia/Height band mm.: 200 - Spessore/Thickness mm.: 22/13 - Fori/Holes: 14 <p>Meritor system Con rivetti/With rivets</p> | WVA 19116 WVA 19119 2992123 2992124 2992125 | AS5029 AS5029+10 AS5029+20 |



Connessione / Connected:



R6001

| Emmerre | Adattabile a / Adaptable to | Dettagli / Detail | Applicazioni / Applications |
|---|-----------------------------|---|-----------------------------|
| AC1653 | WVA 19574 | - Qty set: 8 - Rivetti/Rivet: 8 x 16 T16 | Eco Eco Maxx |
| AC1653+10 | 0309214450 | - Ø tamburo freno/brake drum mm.: 300 | |
| AC1653+20 | | - WVA 19574 (8 pcs.); - Lunghezza/Lenght mm.: 145 - Altezza fascia/Height band mm.: 200 - Spessore/Thickness mm.: 17/11 - Fori/Holes: 8 | |
| Con rivetti/With rivets | | | |
|  | | | |

Connessione / Connected:



R6000

| | | | |
|--|--------------------------|---|-----------------------------|
| AS5052 | WVA 19902 | - Qty set: 8 - Rivetti/Rivet: 8 x 18 T16 | Eco Eco Plus Eco Maxx |
| AS5052+10 | WVA 19903 | - Ø tamburo freno/brake drum mm.: 360 | |
| AS5052+20 | 0309219550 0309219540 | - WVA 19902 (4 pcs.); - Lunghezza/Lenght mm.: 159 - Altezza fascia/Height band mm.: 200 - Spessore/Thickness mm.: 17,5/11,5 - Fori/Holes: 8 | |
| | | - WVA 19903 (4 pcs.); - Lunghezza/Lenght mm.: 190 - Altezza fascia/Height band mm.: 200 - Spessore/Thickness mm.: 17,5/9 - Fori/Holes: 10 | |
| Con rivetti/With rivets | | | |
|  | | | |

Connessione / Connected:



R6001

CEPPI FRENO E RIVETTI
BRAKE LININGS AND RIVETS
GARNITURES DE FREIN ET RIVETS
BREMSKLOETZE UND NIETEN
ТОРМОЗНЫЕ НАКЛАДКИ И ЗАКЛЕПКИ
FORROS DE FRENO Y REMACHES

EMMERRE
 spare parts for trucks and trailers

BPW

| Applicazioni / Applications | Dettagli / Detail | Adattabile a / Adaptable to | Emmerre |
|-----------------------------|--|---|---|
| Eco Eco Plus Eco Maxx | - Qty set: 8 - Rivetti/Rivet: 8 x 20 T16 - Ø tamburo freno/brake drum mm.: 420 - WVA 19200 (8 pcs.): - Lunghezza/Length mm.: 205 - Altezza fascia/Height band mm.: 160 - Spessore/Thickness mm.: 17,5/11,5 - Fori/Holes: 10 | WVA 19200 0309226050 0309226110 0309225460 | AC1882 AC1882+10 AC1882+20 |

Senza rivetti/Without rivets



| Connessione / Connected: | | | |
|---|--|---|---|
|  R6002 | | | |
| Eco Eco Plus Eco Maxx | - Qty set: 8 - Rivetti/Rivet: 8 x 16 T16 - Ø tamburo freno/brake drum mm.: 420 - WVA 19032 (8 pcs.): - Lunghezza/Length mm.: 205 - Altezza fascia/Height band mm.: 180 - Spessore/Thickness mm.: 17,5/11,5 - Fori/Holes: 10 | WVA 19032 0309226570 0309226700 0309226480 | AC1150 AC1150+10 AC1150+20 AC1150+30 |

**Con indicatore usura foro/
 With wear indicator hole
 Con rivetti/With rivets**

Omologazione/Homologation Nr.:
 E9 90R-02B1223/2323
 E11 90R-02B01229/27011



| Connessione / Connected: | | | |
|---|--|--|--|
|  R6000 | | | |

I riferimenti indicati non sono originali ma perfettamente intercambiabili. I codici originali e le case costruttrici sono indicati a puro titolo informativo
 The details described are not original but perfectly interchangeable. The original references and manufacturer names are given for information purposes only.

| Emmerre | Adattabile a / Adaptable to | Dettagli / Detail | Applicazioni / Applications |
|---|-----------------------------|---------------------------------------|--|
| AC1394 | WVA 19094 | - Qty set: 8 | Eco |
| AC1394+10 | 0309227010 | - Rivetti/Rivet: 8 x 16 T16 | Eco Plus |
| AC1394+20 | 0309227060 | - Ø tamburo freno/brake drum mm.: 420 | Eco Maxx |
| AC1394+30 | 0309227150 | - WVA 19094 (8 pcs.): | |
| | | - Lunghezza/Lenght mm.: 205 | |
| | | - Altezza fascia/Height band mm.: 200 | |
| | | - Spessore/Thickness mm.: 17,5/11,5 | |
| | | - Fori/Holes: 10 | |
| <p>Con indicatore usura foro/ With wear indicator hole Con rivetti/With rivets</p> | | | |
| <p>Omologazione/Homologation Nr.: E9 90R-02B1223/1073 E11 90R-02B01229/27012</p> | | | |
|  | | | |
| | | | Connessione / Connected:  R6000 |

CEPPI FRENO E RIVETTI
BRAKE LININGS AND RIVETS
GARNITURES DE FREIN ET RIVETS
BREMSKLOETZE UND NIETEN
ТОРМОЗНЫЕ НАКЛАДКИ И ЗАКЛЕПКИ
FORROS DE FRENO Y REMACHES

EMMERRE
 spare parts for trucks and trailers

COMETTO

| Applicazioni / Applications | Dettagli / Detail | Adattabile a / Adaptable to | Emmerre |
|-----------------------------|---|-----------------------------|---|
| | <ul style="list-style-type: none"> - Qty set: 8 - Rivetti/Rivet: 8 x 16 T16 - Ø tamburo freno/brake drum mm.: 300 | WVA 19574 0309214450 | AC1653 AC1653+10 AC1653+20 |
| | <ul style="list-style-type: none"> - WVA 19574 (8 pcs.): - Lunghezza/Lenght mm.: 145 - Altezza fascia/Height band mm.: 200 - Spessore/Thickness mm.: 17/11 - Fori/Holes: 8 | | |

Con rivetti/With rivets



| Connessione / Connected: | | | |
|---|--|---|---|
|  R6000 | <ul style="list-style-type: none"> - Qty set: 8 - Rivetti/Rivet: 8 x 16 T16 - Ø tamburo freno/brake drum mm.: 420 | WVA 19094 0309227010 0309227060 0309227150 | AC1394 AC1394+10 AC1394+20 AC1394+30 |
| | <ul style="list-style-type: none"> - WVA 19094 (8 pcs.): - Lunghezza/Lenght mm.: 205 - Altezza fascia/Height band mm.: 200 - Spessore/Thickness mm.: 17,5/11,5 - Fori/Holes: 10 | | |

Con rivetti/With rivets

Omologazione/Homologation Nr.:
E9 90R-02B1223/1073
E11 90R-02B01229/27012



| Connessione / Connected: | | | |
|---|--|--|--|
|  R6000 | | | |

I riferimenti indicati non sono originali ma perfettamente intercambiabili. I codici originali e le case costruttrici sono indicati a puro titolo informativo
 The details described are not original but perfectly interchangeable. The original references and manufacturer names are given for information purposes only.

| Emmerre | Adattabile a / Adaptable to | Dettagli / Detail | Applicazioni / Applications |
|---|-----------------------------|--|-----------------------------|
| AS5050 AS5050+10 AS5050+20 AS5050+30 | WVA 19036 WVA 19037 | - Qty set: 8 - Rivetti/Rivet: 6,3 x 18 T12 - Ø tamburo freno/brake drum mm.: 419 - WVA 19036 (4 pcs.): - Lunghezza/Lenght mm.: 190 - Altezza fascia/Height band mm.: 178 - Spessore/Thickness mm.: 18/14,5 - Fori/Holes: 12 - WVA 19037 (4 pcs.): - Lunghezza/Lenght mm.: 195 - Altezza fascia/Height band mm.: 178 - Spessore/Thickness mm.: 18/10 - Fori/Holes: 12 | |
|  | | <p>Con rivetti/With rivets</p> | |

Connessione / Connected:  R6007



| | | | |
|---|------------------------|--|--|
| AS5056 AS5056+10 AS5056+20 | WVA 19365 WVA 19366 | - Qty set: 8 - Rivetti/Rivet: 6,3 x 17,5 T12 - Ø tamburo freno/brake drum mm.: 419 - WVA 19365 (4 pcs.): - Lunghezza/Lenght mm.: 195 - Altezza fascia/Height band mm.: 203 - Spessore/Thickness mm.: 18/10,5 - Fori/Holes: 12 - WVA 19366 (4 pcs.): - Lunghezza/Lenght mm.: 189 - Altezza fascia/Height band mm.: 203 - Spessore/Thickness mm.: 19/15 - Fori/Holes: 12 | |
|  | | <p>Senza rivetti/Without rivets</p> | |

Connessione / Connected:  R6007

**CEPPI FRENO E RIVETTI
BRAKE LININGS AND RIVETS
GARNITURES DE FREIN ET RIVETS
BREMSKLOETZE UND NIETEN
ТОРМОЗНЫЕ НАКЛАДКИ И ЗАКЛЕПКИ
FORROS DE FRENO Y REMACHES**

EMMERRE
spare parts for trucks and trailers

COMETTO

| Applicazioni / Applications | Dettagli / Detail | Adattabile a / Adaptable to | Emmerre |
|-----------------------------|--|--|---|
| | <ul style="list-style-type: none"> - Qty set: 8 - Rivetti/Rivet: 6,3 x 17,5 T12 - Ø tamburo freno/brake drum mm.: 311 | <ul style="list-style-type: none"> WVA 19604 WVA 19605 | <p>AS5051 AS5051+10</p> |
| | <ul style="list-style-type: none"> - WVA 19604 (4 pcs.): - Lunghezza/Length mm.: 125 - Altezza fascia/Height band mm.: 190 - Spessore/Thickness mm.: 15/8 - Fori/Holes: 10 | | |
| | <ul style="list-style-type: none"> - WVA 19605 (4 pcs.): - Lunghezza/Length mm.: 158 - Altezza fascia/Height band mm.: 190 - Spessore/Thickness mm.: 15/12 - Fori/Holes: 10 | | |
| | <p><u>Senza rivetti/Without rivets</u></p> | | |
| |  | | |
| | <p>Connessione / Connected:  R6007</p> | | |

| Emmerre | Adattabile a / Adaptable to | Dettagli / Detail | Applicazioni / Applications |
|------------------|-----------------------------|---------------------------------------|-----------------------------|
| AS5000 | WVA 19010 | - Qty set: 8 | FA 65/75/85/95 |
| AS5000+10 | WVA 19011 | - Rivetti/Rivet: 6,3 x 20 T12 | CF 65/75/85 |
| AS5000+20 | 1808124 | - Ø tamburo freno/brake drum mm.: 420 | XF 95 |
| | 682857 | - WVA 19010 (4 pcs.): | |
| | 683274 | - Lunghezza/Lenght mm.: 176 | |
| | 682416 | - Altezza fascia/Height band mm.: 150 | |
| | | - Spessore/Thickness mm.: 20/17 | |
| | 1808125 | - Fori/Holes: 8 | |
| | | - WVA 19011 (4 pcs.): | |
| | | - Lunghezza/Lenght mm.: 178 | |
| | | - Altezza fascia/Height band mm.: 150 | |
| | | - Spessore/Thickness mm.: 20/12 | |
| | | - Fori/Holes: 8 | |



Senza rivetti/ Without rivets

Connessione / Connected:  R6008

| | | | |
|------------------|-----------|---------------------------------------|----------------|
| AS5001 | WVA 19063 | - Qty set: 8 | FA 65/75/85/95 |
| AS5001+10 | WVA 19064 | - Rivetti/Rivet: 6,3 x 20 T12 | CF 65/75/85 |
| AS5001+20 | 1781321 | - Ø tamburo freno/brake drum mm.: 420 | XF 95 |
| | 682861 | - WVA 19063 (4 pcs.): | |
| | 683278 | - Lunghezza/Lenght mm.: 179 | |
| | | - Altezza fascia/Height band mm.: 200 | |
| | | - Spessore/Thickness mm.: 20/12 | |
| | | - Fori/Holes: 16 | |
| | | - WVA 19064 (4 pcs.): | |
| | | - Lunghezza/Lenght mm.: 176 | |
| | | - Altezza fascia/Height band mm.: 200 | |
| | | - Spessore/Thickness mm.: 20/17 | |
| | | - Fori/Holes: 16 | |



Senza rivetti/ Without rivets

Connessione / Connected:  R6008

CEPPI FRENO E RIVETTI
BRAKE LININGS AND RIVETS
GARNITURES DE FREIN ET RIVETS
BREMSKLOETZE UND NIETEN
ТОРМОЗНЫЕ НАКЛАДКИ И ЗАКЛЕПКИ
FORROS DE FRENO Y REMACHES

EMMERRE
 spare parts for trucks and trailers

DAF

| Applicazioni / Applications | Dettagli / Detail | Adattabile a / Adaptable to | Emmerre |
|-----------------------------|--|---|---------------|
| FA 95 | <ul style="list-style-type: none"> - Qty set: 8 - Rivetti/Rivet: 6,3 x 17,5 T12 - Ø tamburo freno/brake drum mm.: 420 <ul style="list-style-type: none"> - WVA 19900 (4 pcs.): - Lunghezza/Length mm.: 176 - Altezza fascia/Height band mm.: 150 - Spessore/Thickness mm.: 19/16 - Fori/Holes: 8 <ul style="list-style-type: none"> - WVA 19901 (4 pcs.): - Lunghezza/Length mm.: 178 - Altezza fascia/Height band mm.: 150 - Spessore/Thickness mm.: 19/12 - Fori/Holes: 8 | WVA 19900 WVA 19901 1808136 682845 683021 682110 | AS5005 |

Senza rivetti/Without rivets



| Connesione / Connected: | R6007 | | |
|-------------------------|--|---|---|
| FA 95 | <ul style="list-style-type: none"> - Qty set: 8 - Rivetti/Rivet: 6,3 x 17,5 T12 - Ø tamburo freno/brake drum mm.: 420 <ul style="list-style-type: none"> - WVA 19890 (4 pcs.): - Lunghezza/Length mm.: 179 - Altezza fascia/Height band mm.: 200 - Spessore/Thickness mm.: 18,5/11,5 - Fori/Holes: 16 <ul style="list-style-type: none"> - WVA 19891 (4 pcs.): - Lunghezza/Length mm.: 176 - Altezza fascia/Height band mm.: 200 - Spessore/Thickness mm.: 18,5/16 - Fori/Holes: 16 | WVA 19890 WVA 19891 682849 683025 683270 682105 1781360 286851 | AS5007 AS5007+10 AS5007+20 |

Senza rivetti/Without rivets



Ceppi Freno
 Brake Linings

| Emmerre | Adattabile a / Adaptable to | Dettagli / Detail | Applicazioni / Applications |
|------------------|-----------------------------|--|-----------------------------|
| AC1882 | WVA 19200 | - Qty set: 8 - Rivetti/Rivet: 8 x 20 T16 - Ø tamburo freno/brake drum mm.: 420 | |
| AC1882+10 | 0309226050 | | |
| AC1882+20 | 0309226110 | | |
| | 0309225460 | - WVA 19200 (8 pcs.): - Lunghezza/Lenght mm.: 205 - Altezza fascia/Height band mm.: 160 - Spessore/Thickness mm.: 17,5/11,5 - Fori/Holes: 10 | |

Senza rivetti/Without rivets



Connessione / Connected:  R6002

| | | | |
|------------------|-----------|--|--|
| AS5050 | WVA 19036 | - Qty set: 8 - Rivetti/Rivet: 6,3 x 18 T12 - Ø tamburo freno/brake drum mm.: 419 | |
| AS5050+10 | WVA 19037 | | |
| AS5050+20 | | | |
| AS5050+30 | | - WVA 19036 (4 pcs.): - Lunghezza/Lenght mm.: 190 - Altezza fascia/Height band mm.: 178 - Spessore/Thickness mm.: 18/14,5 - Fori/Holes: 12 | |
| | | - WVA 19037 (4 pcs.): - Lunghezza/Lenght mm.: 195 - Altezza fascia/Height band mm.: 178 - Spessore/Thickness mm.: 18/10 - Fori/Holes: 12 | |

Con rivetti/With rivets



Connessione / Connected:  R6007



**CEPPI FRENO E RIVETTI
BRAKE LININGS AND RIVETS
GARNITURES DE FREIN ET RIVETS
BREMSKLOETZE UND NIETEN
ТОРМОЗНЫЕ НАКЛАДКИ И ЗАКЛЕПКИ
FORROS DE FRENO Y REMACHES**

EMMERRE
spare parts for trucks and trailers

FRUEHAUF

| Applicazioni / Applications | Dettagli / Detail | Adattabile a / Adaptable to | Emmerre |
|-----------------------------|---|--------------------------------|----------------------------------|
| | <ul style="list-style-type: none"> - Qty set: 8 - Rivetti/Rivet: 5 x 15 T12 - Ø tamburo freno/brake drum mm.: 419 <ul style="list-style-type: none"> - WVA 19613 (4 pcs.): - Lunghezza/Lenght mm.: 190 - Altezza fascia/Height band mm.: 178 - Spessore/Thickness mm.: 18,5/15 - Fori/Holes: 16 <ul style="list-style-type: none"> - WVA 19614 (4 pcs.): - Lunghezza/Lenght mm.: 195 - Altezza fascia/Height band mm.: 178 - Spessore/Thickness mm.: 18,5/10,5 - Fori/Holes: 16 <p>Senza rivetti/Without rivets</p> | <p>WVA 19613 WVA 19614</p> | <p>Emmerre AS5015</p> |



| Connessione / Connected: | | | |
|---|---|--------------------------------|--|
|  R6018 | <ul style="list-style-type: none"> - Qty set: 8 - Rivetti/Rivet: 6,3 x 17,5 T12 - Ø tamburo freno/brake drum mm.: 419 <ul style="list-style-type: none"> - WVA 19365 (4 pcs.): - Lunghezza/Lenght mm.: 195 - Altezza fascia/Height band mm.: 203 - Spessore/Thickness mm.: 18/10,5 - Fori/Holes: 12 <ul style="list-style-type: none"> - WVA 19386 (4 pcs.): - Lunghezza/Lenght mm.: 189 - Altezza fascia/Height band mm.: 203 - Spessore/Thickness mm.: 19/15 - Fori/Holes: 12 <p>Senza rivetti/Without rivets</p> | <p>WVA 19365 WVA 19366</p> | <p>AS5056 AS5056+10 AS5056+20</p> |
|  R6007 | | | |



I riferimenti indicati non sono originali ma perfettamente intercambiabili. I codici originali e le case costruttrici sono indicati a puro titolo informativo
The details described are not original but perfectly interchangeable. The original references and manufacturer names are given for information purposes only.

| Emmerre | Adattabile a / Adaptable to | Dettagli / Detail | Applicazioni / Applications |
|--|---|---|-----------------------------|
| AS5063 AS5063+10 AS5063+20 | WVA 19557 WVA 19606 | - Qty set: 8 - Rivetti/Rivet: 5 x 16 T12 - Ø tamburo freno/brake drum mm.: 419 - WVA 19557 (4 pcs.): - Lunghezza/Lenght mm.: 194 - Altezza fascia/Height band mm.: 203 - Spessore/Thickness mm.: 18,7/11 - Fori/Holes: 16 - WVA 19606 (4 pcs.): - Lunghezza/Lenght mm.: 189 - Altezza fascia/Height band mm.: 203 - Spessore/Thickness mm.: 19/15,8 - Fori/Holes: 16 Senza rivetti/Without rivets | |
| Connessione / Connected:  R6108 | | | |
| AC1150 AC1150+10 AC1150+20 AC1150+30 | WVA 19032 0309226570 0309226700 0309226480 | - Qty set: 8 - Rivetti/Rivet: 8 x 16 T16 - Ø tamburo freno/brake drum mm.: 420 - WVA 19032 (8 pcs.): - Lunghezza/Lenght mm.: 205 - Altezza fascia/Height band mm.: 180 - Spessore/Thickness mm.: 17,5/11,5 - Fori/Holes: 10 Con indicatore usura foro/ With wear indicator hole Con rivetti/With rivets | |
| Connessione / Connected:  R6000 | | | |





**CEPPI FRENO E RIVETTI
BRAKE LININGS AND RIVETS
GARNITURES DE FREIN ET RIVETS
BREMSKLOETZE UND NIETEN
ТОРМОЗНЫЕ НАКЛАДКИ И ЗАКЛЕПКИ
FORROS DE FRENO Y REMACHES**







EMMERRE
spare parts for trucks and trailers

FRUEHAUF

| Applicazioni / Applications | Dettagli / Detail | Adattabile a / Adaptable to | Emmerre |
|---|--|--|---|
| | <ul style="list-style-type: none"> - Qty set: 8 - Rivetti/Rivet: 8 x 16 T16 - Ø tamburo freno/brake drum mm.: 420 - WVA 19094 (8 pcs.): - Lunghezza/Length mm.: 205 - Altezza fascia/Height band mm.: 200 - Spessore/Thickness mm.: 17,5/11,5 - Fori/Holes: 10 <p><u>Con indicatore usura foro/With wear indicator hole</u> <u>Con rivetti/With rivets</u></p> <p>Omologazione/Homologation Nr.: E9 90R-02B1223/1073 E11 90R-02B01229/27012</p> | <p>WVA 19094</p> <p>0309227010 0309227060 0309227150</p> | <p>AC1394 AC1394+10 AC1394+20 AC1394+30</p> |
|  | | | |

| Connesione / Connected: | | | |
|---|---|--------------------------------|--|
|  R6000 | <ul style="list-style-type: none"> - Qty set: 8 - Rivetti/Rivet: 6,3 x 18 T12 - Ø tamburo freno/brake drum mm.: 419 - WVA 19370 (4 pcs.): - Lunghezza/Length mm.: 190 - Altezza fascia/Height band mm.: 219 - Spessore/Thickness mm.: 18,5/15 - Fori/Holes: 12 - WVA 19369 (4 pcs.): - Lunghezza/Length mm.: 192 - Altezza fascia/Height band mm.: 219 - Spessore/Thickness mm.: 18/10 - Fori/Holes: 12 <p><u>Senza rivetti/Without rivets</u></p> | <p>WVA 19370 WVA 19369</p> | <p>AS5004 AS5004+10 AS5004+20</p> |
|  R6007 |  | | |

I riferimenti indicati non sono originali ma perfettamente intercambiabili. I codici originali e le case costruttrici sono indicati a puro titolo informativo
The details described are not original but perfectly interchangeable. The original references and manufacturer names are given for information purposes only.

| Emmerre | Adattabile a / Adaptable to | Dettagli / Detail | Applicazioni / Applications |
|--|-----------------------------|--|---|
| AS5029 AS5029+10 AS5029+20 | WVA 19116 | - Qty set: 8 | Eurotakker Cursor |
| | WVA 19119 | - Rivetti/Rivet: 8 x 18 T16 - Ø tamburo freno/brake drum mm.: 410 | |
| | 2992123 | - WVA 19116 (4 pcs.): - Lunghezza/Length mm.: 196 - Altezza fascia/Height band mm.: 200 - Spessore/Thickness mm.: 22/13 - Fori/Holes: 12 | |
| | 2992124 | - WVA 19119 (4 pcs.): - Lunghezza/Length mm.: 196 - Altezza fascia/Height band mm.: 200 - Spessore/Thickness mm.: 22/13 - Fori/Holes: 14 | |
| | 2992125 | | |
|  | | Con rivetti/With rivets | |
| Connessione / Connected:  2992378  R6001 | | | |
| AS5071 AS5071+10 AS5071+20 | WVA 19110 | - Qty set: 8 | Tector Eurotrakker Eurotrakker Cursor |
| | WVA 19109 | - Rivetti/Rivet: 8 x 18 T16 - Ø tamburo freno/brake drum mm.: 410 - Anteriore/Front - Duplex | |
| | 2992113 | - WVA 19110 (4 pcs.): - Lunghezza/Length mm.: 196 - Altezza fascia/Height band mm.: 180 - Spessore/Thickness mm.: 22/13 - Fori/Holes: 14 | |
| | 2992114 | - WVA 19109 (4 pcs.): - Lunghezza/Length mm.: 196 - Altezza fascia/Height band mm.: 180 - Spessore/Thickness mm.: 22/13 - Fori/Holes: 12 | |
| | 2992115 | | |
|  | | Meritor system Con rivetti/With rivets | |
| Connessione / Connected:  2992375  R6001 | | | |

CEPPI FRENO E RIVETTI
BRAKE LININGS AND RIVETS
GARNITURES DE FREIN ET RIVETS
BREMSKLOETZE UND NIETEN
ТОРМОЗНЫЕ НАКЛАДКИ И ЗАКЛЕПКИ
FORROS DE FRENO Y REMACHES

EMMERRE
 spare parts for trucks and trailers

IVECO

| Applicazioni / Applications | Dettagli / Detail | Adattabile a / Adaptable to | Emmerre |
|-------------------------------------|---|---|---|
| Eurotech Eurostar Eurotrakker | <ul style="list-style-type: none"> - Qty set: 8 - Rivetti/Rivet: 8 x 18 T16 - Ø tamburo freno/brake drum mm.: 410 - Anteriore/Front - Simplex <ul style="list-style-type: none"> - WVA 19100 (6 pcs.): - Lunghezza/Lenght mm.: 204 - Altezza fascia/Height band mm.: 182 - Spessore/Thickness mm.: 21/16 - Fori/Holes: 12 <ul style="list-style-type: none"> - WVA 19099 (2 pcs.): - Lunghezza/Lenght mm.: 204 - Altezza fascia/Height band mm.: 182 - Spessore/Thickness mm.: 21/16 - Fori/Holes: 14 <p>Rockwell system Senza rivetti/Without rivets</p> | WVA 19100 WVA 19099 2992002 2991918 2991919 2992004 2991920 | AS5031 AS5031+10 AS5031+20 |



Connessione / Connected:  2991755  R6001

| | | | |
|--------------------------|---|---|-----------------------------------|
| Eurotrakker Series 1° | <ul style="list-style-type: none"> - Qty set: 8 - Rivetti/Rivet: 8 x 16 T16 - Ø tamburo freno/brake drum mm.: 410 - Anteriore/Front <ul style="list-style-type: none"> - WVA 19556 (6 pcs.): - Lunghezza/Lenght mm.: 196 - Altezza fascia/Height band mm.: 180 - Spessore/Thickness mm.: 21/12 - Fori/Holes: 12 <ul style="list-style-type: none"> - WVA 19555 (2 pcs.): - Lunghezza/Lenght mm.: 196 - Altezza fascia/Height band mm.: 180 - Spessore/Thickness mm.: 21/12 - Fori/Holes: 14 <p>Rockwell system Senza rivetti/Without rivets</p> | WVA 19556 WVA 19555 1906371 1906372 1906373 | AS5025 AS5025+20 |
|--------------------------|---|---|-----------------------------------|



Connessione / Connected:  1906365  R6000

I riferimenti indicati non sono originali ma perfettamente intercambiabili. I codici originali e le case costruttrici sono indicati a puro titolo informativo
 The details described are not original but perfectly interchangeable. The original references and manufacturer names are given for information purposes only.

| Emmerre | Adattabile a / Adaptable to | Dettagli / Detail | Applicazioni / Applications |
|--|-----------------------------|---|-----------------------------|
| AS5026 | WVA 19556 | - Qty set: 8 | Eurotech |
| AS5026+10 | WVA 19714 | - Rivetti/Rivet: 8 x 18 T16 | Eurostar |
| AS5026+20 | WVA 19715 | - Ø tamburo freno/brake drum mm.: 410 | Eurotrækker |
| | 1906407 | - Anteriore—posteriore/Front—Rear - Simplex | |
| | 1906408 | - WVA 19556 (4 pcs.): | |
| | 1906409 | - Lunghezza/Lenght mm.: 196 | |
| | | - Altezza fascia/Height band mm.: 180 | |
| | | - Spessore/Thickness mm.: 21/12 | |
| | | - Fori/Holes: 12 | |
| | | - WVA 19714 (2 pcs.): | |
| | | - Lunghezza/Lenght mm.: 196 | |
| | | - Altezza fascia/Height band mm.: 180 | |
| | | - Spessore/Thickness mm.: 22/14,3 | |
| | | - Fori/Holes: 14 | |
| | | - WVA 19715 (2 pcs.): | |
| | | - Lunghezza/Lenght mm.: 196 | |
| | | - Altezza fascia/Height band mm.: 180 | |
| | | - Spessore/Thickness mm.: 22/12 | |
| | | - Fori/Holes: 12 | |
|  | | <p>Rockwell system Senza rivetti/Without rivets</p> | |

Connessione / Connected:  1906404

| | | | |
|---|-----------|---|--------------------|
| AS5023 | WVA 19263 | - Qty set: 8 | Eurotech |
| AS5023+10 | WVA 19343 | - Rivetti/Rivet: 8 x 18 T16 | Eurostar |
| | 2991900 | - Ø tamburo freno/brake drum mm.: 410 | Eurotrækker Cursor |
| | 1906202 | - Posteriore/Rear - Simplex | Stralis |
| | 2991901 | - WVA 19263 (6 pcs.): | |
| | 2991902 | - Lunghezza/Lenght mm.: 202 | |
| | | - Altezza fascia/Height band mm.: 200 | |
| | | - Spessore/Thickness mm.: 19,5/15 | |
| | | - Fori/Holes: 14 | |
| | | - WVA 19343 (2 pcs.): | |
| | | - Lunghezza/Lenght mm.: 202 | |
| | | - Altezza fascia/Height band mm.: 200 | |
| | | - Spessore/Thickness mm.: 19,5/15 | |
| | | - Fori/Holes: 16 | |
|  | | <p>Perrot system Senza rivetti/Without rivets</p> | |

Connessione / Connected:  1906227  R6001



CEPPI FRENO E RIVETTI
BRAKE LININGS AND RIVETS
GARNITURES DE FREIN ET RIVETS
BREMSKLOETZE UND NIETEN
ТОРМОЗНЫЕ НАКЛАДКИ И ЗАКЛЕПКИ
FORROS DE FRENO Y REMACHES

EMMERRE
 spare parts for trucks and trailers

IVECO

| Applicazioni / Applications | Dettagli / Detail | Adattabile a / Adaptable to | Emmerre |
|---|--|--|---|
| Eurotech Eurostar Eurotrakker Cursor Stralis | - Qty set: 8 - Rivetti/Rivet: 8 x 18 T16 - Ø tamburo freno/brake drum mm.: 410 - Posteriore/Rear - WVA 19098 (6 pcs.): - Lunghezza/Lenght mm.: 204 - Altezza fascia/Height band mm.: 200 - Spessore/Thickness mm.: 21/16 - Fori/Holes: 12 - WVA 19091 (2 pcs.): - Lunghezza/Lenght mm.: 204 - Altezza fascia/Height band mm.: 200 - Spessore/Thickness mm.: 21/16 - Fori/Holes: 14 Perrot (Wabco) system Con rivetti/With rivets | WVA 19098 WVA 19091 2992005 2991760 2992006 2992007 | AS5024 AS5024+10 AS5024+20 |



| Connessione / Connected:  2991759  R6001 | | | |
|--|--|---|-----------------------------------|
| Eurotech Eurostar Eurotrakker Cursor Series 1° | - Qty set: 8 - Rivetti/Rivet: 8 x 18 T16 - Ø tamburo freno/brake drum mm.: 410 - Posteriore/Rear - Simplex 5° - WVA 19553 (6 pcs.): - Lunghezza/Lenght mm.: 196 - Altezza fascia/Height band mm.: 200 - Spessore/Thickness mm.: 21/12,5 - Fori/Holes: 12 - WVA 19554 (2 pcs.): - Lunghezza/Lenght mm.: 196 - Altezza fascia/Height band mm.: 200 - Spessore/Thickness mm.: 21/12,5 - Fori/Holes: 14 Rockwell system Senza rivetti/Without rivets | WVA 19553 WVA 19554 1906374 1906375 1906376 | AS5018 AS5018+20 |





Connessione / Connected:  1906368  R6001

I riferimenti indicati non sono originali ma perfettamente intercambiabili. I codici originali e le case costruttrici sono indicati a puro titolo informativo
 The details described are not original but perfectly interchangeable. The original references and manufacturer names are given for information purposes only.

| Emmerre | Adattabile a / Adaptable to | Dettagli / Detail | Applicazioni / Applications |
|--|-----------------------------|---|-----------------------------|
| AS5010 | WVA 19553 | - Qty set: 8 | Eurotech |
| AS5010+10 | WVA 19716 | - Rivetti/Rivet: 8 x 18 T16 | Eurostar |
| AS5010+20 | WVA 19717 | - Ø tamburo freno/brake drum mm.: 410 | Eurotrakker Cursor |
| | | - Posteriore/Rear - Simplex - 15° | L.T. |
| | 1906413 | | |
| | 1906414 | - WVA 19553 (4 pcs.): | |
| | | - Lunghezza/Length mm.: 196 | |
| | 1906415 | - Altezza fascia/Height band mm.: 200 | |
| | | - Spessore/Thickness mm.: 21/12,5 | |
| | | - Fori/Holes: 12 | |
| | | - WVA 19716 (2 pcs.): | |
| | | - Lunghezza/Length mm.: 196 | |
| | | - Altezza fascia/Height band mm.: 200 | |
| | | - Spessore/Thickness mm.: 22/14,5 | |
| | | - Fori/Holes: 14 | |
| | | - WVA 19717 (2 pcs.): | |
| | | - Lunghezza/Length mm.: 196 | |
| | | - Altezza fascia/Height band mm.: 200 | |
| | | - Spessore/Thickness mm.: 22/11,8 | |
| | | - Fori/Holes: 12 | |
|  | | <p>Rockwell system Con rivetti/With rivets</p> | |

Connessione / Connected:  R6001

| | | | |
|---|-------------------|--|-------------|
| AS5022 | WVA 17099 (17318) | - Qty set: 4 | Daily 59.12 |
| | WVA 17096 (17313) | - Rivetti/Rivet: 6 x 15 T12 | |
| | 1906197 | - Ø tamburo freno/brake drum mm.: 310 | |
| | 1906198 | - WVA 17099 (2 pcs.): | |
| | | - Lunghezza/Length mm.: 274 | |
| | | - Altezza fascia/Height band mm.: 100 | |
| | | - Spessore/Thickness mm.: 12,6 | |
| | | - Fori/Holes: 14 | |
| | | - WVA 17096 (2 pcs.): | |
| | | - Lunghezza/Length mm.: 236 | |
| | | - Altezza fascia/Height band mm.: 100 | |
| | | - Spessore/Thickness mm.: 12,6 | |
| | | - Fori/Holes: 12 | |
|  | | <p>Perrot system Senza rivetti/Without rivets</p> | |
| | | Connessione / Connected:  1906196  R6200 | |

CEPPI FRENO E RIVETTI
BRAKE LININGS AND RIVETS
GARNITURES DE FREIN ET RIVETS
BREMSKLOETZE UND NIETEN
ТОРМОЗНЫЕ НАКЛАДКИ И ЗАКЛЕПКИ
FORROS DE FRENO Y REMACHES

EMMERRE
 spare parts for trucks and trailers

IVECO

| Applicazioni / Applications | Dettagli / Detail | Adattabile a / Adaptable to | Emmerre |
|--|---|--|---|
| Eurocargo 120-130-135-150- 260-280-320 | - Qty set: 4 - Rivetti/Rivet: 8 x 16 T16 - Ø tamburo freno/brake drum mm.: 360 | WVA 19503 1906221 1906222 1906223 | AC2103 AC2103+10 AC2103+20 |
| | - WVA 19503 (4 pcs.): - Lunghezza/Length mm.: 315 - Altezza fascia/Height band mm.: 170 - Spessore/Thickness mm.: 16 - Fori/Holes: 20 | | |
| | <u>Con indicatore usura foro/</u> <u>With wear indicator hole</u> <u>Senza rivetti/Without rivets</u> | | |







| Connessione / Connected: | 1906361-2992530 | R6000 | |
|---|--|--|--------------------------------------|
| 160F26-26T 170NC26-33 190NC-NT26-33 190F26-30-33-35- 220F35 | - Qty set: 8 - Rivetti/Rivet: 8 x 23 T13 - Ø tamburo freno/brake drum mm.: 421 | WVA 17870 WVA 17869 2991910 2991911 | AS5017+10 AS5017+20 |
| | - WVA 17870 (2 pcs.): - Lunghezza/Length mm.: 145 - Altezza fascia/Height band mm.: 140 - Spessore/Thickness mm.: 12,5 - Fori/Holes: 6 | | |
| | - WVA 17869 (6 pcs.): - Lunghezza/Length mm.: 197 - Altezza fascia/Height band mm.: 140 - Spessore/Thickness mm.: 12,5 - Fori/Holes: 8 | | |
| | <u>Senza rivetti/Without rivets</u> | | |



| Connessione / Connected: | R6205 |
|--------------------------|-------|
|--------------------------|-------|

I riferimenti indicati non sono originali ma perfettamente intercambiabili. I codici originali e le case costruttrici sono indicati a puro titolo informativo
 The details described are not original but perfectly interchangeable. The original references and manufacturer names are given for information purposes only.

| Emmerre | Adattabile a / Adaptable to | Dettagli / Detail | Applicazioni / Applications |
|--|---|--|-------------------------------------|
| AS5021 AS5021+10 | WVA 15743 (15030) WVA 15742 1906380 1906381 1906382 | - Qty set: 4 - Rivetti/Rivet: 5 x 12 T10 - Ø tamburo freno/brake drum mm.: 270 - WVA 15743 (2 pcs.): - Lunghezza/Lenght mm.: 243 - Altezza fascia/Height band mm.: 80 - Spessore/Thickness mm.: 8 - Fori/Holes: 14 - WVA 15742 (2 pcs.): - Lunghezza/Lenght mm.: 210 - Altezza fascia/Height band mm.: 80 - Spessore/Thickness mm.: 8 - Fori/Holes: 12 | Daily 40.10 45.10 49.10-12 |
|  | | | |
| <p>Perrot system Senza rivetti/ Without rivets</p> | | | |
| | | Connessione / Connected:  1906377  R6207 | |

| | | | |
|--|----------------------|---|--|
| AC1111 | WVA 15303 9921061 | - Qty set: 2 - Rivetti/Rivet: 6 x 15 T12 - Ø tamburo freno/brake drum mm.: 350 - WVA 15303 (2 pcs.): - Lunghezza/Lenght mm.: 365 - Altezza fascia/Height band mm.: 60 - Spessore/Thickness mm.: 7 - Fori/Holes: 16 | |
|  | | | |
| | | Connessione / Connected:  R6200 | |

CEPPI FRENO E RIVETTI
BRAKE LININGS AND RIVETS
GARNITURES DE FREIN ET RIVETS
BREMSKLOETZE UND NIETEN
ТОРМОЗНЫЕ НАКЛАДКИ И ЗАКЛЕПКИ
FORROS DE FRENO Y REMACHES

EMMERRE
 spare parts for trucks and trailers

IVECO

| Applicazioni / Applications | Dettagli / Detail | Adattabile a / Adaptable to | Emmerre |
|-----------------------------|--|---------------------------------|---|
| | <ul style="list-style-type: none"> - Qty set: 8 - Rivetti/Rivet: 8 x 23 T13 - Ø tamburo freno/brake drum mm.: 421 | WVA 19694 1906318 4693321 | AC1692 AC1692+10 AC1692+20 |

- WVA 19694 (8 pcs.):
- Lunghezza/Lenght mm.: 197
- Altezza fascia/Height band mm.: 180
- Spessore/Thickness mm.: 12,5
- Fori/Holes: 16

Senza rivetti/Without rivets



Connessione / Connected:  R6205

| | | | |
|----------------------------------|--|---|--|
| 682N3-N4-T3-T4 690N1-N2-N3-N4 | <ul style="list-style-type: none"> - Qty set: 4 - Rivetti/Rivet: 8 x 23 T13 - Ø tamburo freno/brake drum mm.: 420 | WVA 15207 395320 1906311 4023399 | AC251 AC251+10 AC251+20 |
|----------------------------------|--|---|--|

- WVA 15207 (4 pcs.):
- Lunghezza/Lenght mm.: 405
- Altezza fascia/Height band mm.: 90
- Spessore/Thickness mm.: 8
- Fori/Holes: 16

Senza rivetti/Without rivets



Connessione / Connected:  R6205

I riferimenti indicati non sono originali ma perfettamente intercambiabili. I codici originali e le case costruttrici sono indicati a puro titolo informativo
 The details described are not original but perfectly interchangeable. The original references and manufacturer names are given for information purposes only.

| Emmerre | Adattabile a / Adaptable to | Dettagli / Detail | Applicazioni / Applications |
|--------------|-----------------------------|--|-----------------------------|
| AC252 | WVA 15538 | - Qty set: 2 - Rivetti/Rivet: 6 x15T12 - Ø tamburo freno/brake drum mm.: 300 - WVA 15538 (2 pcs.): - Lunghezza/Lenght mm.: 280 - Altezza fascia/Height band mm.: 90 - Spessore/Thickness mm.: 8 - Fori/Holes: 10 <u>Senza rivetti/Without rivets</u> | |



Connessione / Connected:  R6200

| | | | |
|-----------------------------------|---------------------------------|---|--|
| AC1144 AC1144+10 | WVA 15494 1906324 1906325 | - Qty set: 8 - Rivetti/Rivet: 8 x 23 T13 - Ø tamburo freno/brake drum mm.: 420 - WVA 15494 (8 pcs.): - Lunghezza/Lenght mm.: 397 - Altezza fascia/Height band mm.: 90 - Spessore/Thickness mm.: 12 - Fori/Holes: 16 <u>Senza rivetti/Without rivets</u> | 180NC-NT-NTS 300PC-PT (6x4) 619N1-N1P-T1-T1P |
|-----------------------------------|---------------------------------|---|--|



Connessione / Connected:  R6205



CEPPI FRENO E RIVETTI
BRAKE LININGS AND RIVETS
GARNITURES DE FREIN ET RIVETS
BREMSKLOETZE UND NIETEN
ТОРМОЗНЫЕ НАКЛАДКИ И ЗАКЛЕПКИ
FORROS DE FRENO Y REMACHES

EMMERRE
 spare parts for trucks and trailers

IVECO

| Applicazioni / Applications | Dettagli / Detail | Adattabile a / Adaptable to | Emmerre |
|---|---|--|---|
| 159-165-175 330.33/36 Turbostar 190.36/42/48 Eurocargo 130-260 Eurotech 180-190-400 | <ul style="list-style-type: none"> - Qty set: 8 - Rivetti/Rivet: 6,3 x 16 T12 - Ø tamburo freno/brake drum mm.: 381 - Anteriore-posteriore/Front-Rear <p>- WVA 19384 (6 pcs.):</p> <ul style="list-style-type: none"> - Lunghezza/Lenght mm.: 190 - Altezza fascia/Height band mm.: 178 - Spessore/Thickness mm.: 18/12 - Fori/Holes: 12 <p>- WVA 19385 (2 pcs.):</p> <ul style="list-style-type: none"> - Lunghezza/Lenght mm.: 190 - Altezza fascia/Height band mm.: 178 - Spessore/Thickness mm.: 18/12 - Fori/Holes: 14 <p>Rockwell system Senza rivetti/Without rivets</p> | WVA 19384 WVA 19385 2991906 2991903 2991907 2991904 2991908 2991905 | AS5011 AS5011+10 AS5011+20 |



| Connesione / Connected: | | | |
|---|---|---|-----------------------------------|
|  | 93158504-1906032-1906354-1906261 |  | R6006 |
| 160NC-NT 619N-T 684N-T 693N1-T1 697N-T-NP | <ul style="list-style-type: none"> - Qty set: 4 - Rivetti/Rivet: 8 x 23 T13 - Ø tamburo freno/brake drum mm.: 420 <p>- WVA 17482 (4 pcs.):</p> <ul style="list-style-type: none"> - Lunghezza/Lenght mm.: 397 - Altezza fascia/Height band mm.: 125 - Spessore/Thickness mm.: 12 - Fori/Holes: 24 <p>Senza rivetti/Without rivets</p> | WVA 17482 1906322 | AC1137 AC1137+20 |



| Connesione / Connected: | |
|---|-------|
|  | R6205 |

I riferimenti indicati non sono originali ma perfettamente intercambiabili. I codici originali e le case costruttrici sono indicati a puro titolo informativo
 The details described are not original but perfectly interchangeable. The original references and manufacturer names are given for information purposes only.

| Emmerre | Adattabile a / Adaptable to | Dettagli / Detail | Applicazioni / Applications |
|------------------|-----------------------------|---------------------------------------|-----------------------------|
| AC1743+20 | WVA 17885 | - Qty set: 8 | 120.13 |
| | 1906320 | - Rivetti/Rivet: 8 x 23 T13 | 130-20/150NC20 |
| | 1906321 | - Ø tamburo freno/brake drum mm.: 420 | 140F14.20 |
| | | - WVA 17885 (8 pcs.): | 150F14/F17 |
| | | - Lunghezza/Lenght mm.: 211 | 159.17 |
| | | - Altezza fascia/Height band mm.: 134 | |
| | | - Spessore/Thickness mm.: 12,5 | |
| | | - Fori/Holes: 8 | |

Senza rivetti/Without rivets



| Connessione / Connected: | | | R6205 |
|--------------------------|--|--|-------|
|--------------------------|--|--|-------|

| | | | |
|------------------|-------------------|---------------------------------------|--------|
| AC1976 | WVA 19918 (19225) | - Qty set: 4 | 115.14 |
| | 1906397 | - Rivetti/Rivet: 8 x 18 T16 | 115.17 |
| | 1906035 | - Ø tamburo freno/brake drum mm.: 360 | 135.14 |
| AC1976+10 | | - WVA 19918 (4 pcs.): | 135.17 |
| AC1976+20 | 1906398 | - Lunghezza/Lenght mm.: 318 | |
| | 1906399 | - Altezza fascia/Height band mm.: 170 | |
| | | - Spessore/Thickness mm.: 14 | |
| | | - Fori/Holes: 18 | |

Senza rivetti/Without rivets



| Connessione / Connected: | | | R6001 |
|--------------------------|--|--|-------|
|--------------------------|--|--|-------|

| | |
|------------|--|
| 484 | I riferimenti indicati non sono originali ma perfettamente intercambiabili. I codici originali e le case costruttrici sono indicati a puro titolo informativo The details described are not original but perfectly interchangeable. The original references and manufacturer names are given for information purposes only. |
|------------|--|

CEPPI FRENO E RIVETTI
BRAKE LININGS AND RIVETS
GARNITURES DE FREIN ET RIVETS
BREMSKLOETZE UND NIETEN
ТОРМОЗНЫЕ НАКЛАДКИ И ЗАКЛЕПКИ
FORROS DE FRENO Y REMACHES

EMMERRE
 spare parts for trucks and trailers

IVECO

| Applicazioni / Applications | Dettagli / Detail | Adattabile a / Adaptable to | Emmerre |
|---|--|------------------------------|--|
| 100F13 643N-N1-T 650 655N-N1 662N-N1 672N 100NC 100.13 OM 100 OM 110 | - Qty set: 4 - Rivetti/Rivet: 8 x 23 T13 - Ø tamburo freno/brake drum mm.: 420 - WVA 15336 (4 pcs.): - Lunghezza/Lenght mm.: 423 - Altezza fascia/Height band mm.: 90 - Spessore/Thickness mm.: 12 - Fori/Holes: 16 | WVA 15336 (15558) 1906307 | AC261 AC261+10 AC261+20 |

Senza rivetti/Without rivets



| Connessione / Connected: | R6205 | | |
|---|--|---|---|
| Zeta 65.12 70.12 70.14 79.10 79.12 79.13 79.14 | - Qty set: 4 - Rivetti/Rivet: 6 x 15 T12 - Ø tamburo freno/brake drum mm.: 325 - WVA 17635 (2 pcs.): - Lunghezza/Lenght mm.: 249 - Altezza fascia/Height band mm.: 120 - Spessore/Thickness mm.: 12 - Fori/Holes: 12 - WVA 17636 (2 pcs.): - Lunghezza/Lenght mm.: 288 - Altezza fascia/Height band mm.: 120 - Spessore/Thickness mm.: 12 - Fori/Holes: 14 | WVA 17635 WVA 17636 1906237 1906267 1906268 | AS5028 AS5028+10 AS5028+20 |

Senza rivetti/Without rivets



| Connessione / Connected: | R6200 | | |
|--------------------------|-------|--|--|
|--------------------------|-------|--|--|

I riferimenti indicati non sono originali ma perfettamente intercambiabili. I codici originali e le case costruttrici sono indicati a puro titolo informativo
 The details described are not original but perfectly interchangeable. The original references and manufacturer names are given for information purposes only.

| Emmerre | Adattabile a / Adaptable to | Dettagli / Detail | Applicazioni / Applications |
|------------------|-----------------------------|---------------------------------------|-----------------------------|
| AC1995 | WVA 17688 | - Qty set: 4 | Zeta |
| AC1995+10 | 1906238 | - Rivetti/Rivet: 6 x 15 T12 | 90.14 |
| AC1995+20 | | - Ø tamburo freno/brake drum mm.: 325 | 95.14 |

- WVA 17688 (4 pcs.);
- Lunghezza/Length mm.: 248
- Altezza fascia/Height band mm.: 140
- Spessore/Thickness mm.: 12
- Fori/Holes: 12

Senza rivetti/Without rivets



Connessione / Connected:  R6200

| | | | |
|------------------|-----------|---------------------------------------|---------------------|
| AS5027 | WVA 17924 | - Qty set: 4 | Zeta |
| AS5027+10 | WVA 17925 | - Rivetti/Rivet: 6 x 15 T12 | 50.8 - 9 - 10 |
| | 1906055 | - Ø tamburo freno/brake drum mm.: 325 | 55.10 - 13 - 14 |
| | 1906236 | - WVA 17924 (2 pcs.); | 60.8 - 9 - 10 - 11 |
| | | - Lunghezza/Length mm.: 250 | 65.9 - 10 - 11 - 12 |
| | 1906265 | - Altezza fascia/Height band mm.: 100 | 70.12 |
| | 1906266 | - Spessore/Thickness mm.: 12 | |
| | | - Fori/Holes: 12 | |

- WVA 17925 (2 pcs.);
- Lunghezza/Length mm.: 290
- Altezza fascia/Height band mm.: 100
- Spessore/Thickness mm.: 12
- Fori/Holes: 14

Senza rivetti/Without rivets



Connessione / Connected:  7165231  R6200

**CEPPI FRENO E RIVETTI
BRAKE LININGS AND RIVETS
GARNITURES DE FREIN ET RIVETS
BREMSKLOETZE UND NIETEN
ТОРМОЗНЫЕ НАКЛАДКИ И ЗАКЛЕПКИ
FORROS DE FRENO Y REMACHES**

EMMERRE
spare parts for trucks and trailers

IVECO

| Applicazioni / Applications | Dettagli / Detail | Adattabile a / Adaptable to | Emmerre |
|--|--|---|---|
| 625N3 40NC/35 50 - 55NC 50F8 50F9 50F10 55F8 55F9 55F10 A55.10 OM 40-40/35 OM 50-55 | <ul style="list-style-type: none"> - Qty set: 4 - Rivetti/Rivet: 6 x 15 T12 - Ø tamburo freno/brake drum mm.: 325 <ul style="list-style-type: none"> - WVA 15746 (2 pcs.): - Lunghezza/Length mm.: 256 - Altezza fascia/Height band mm.: 80 - Spessore/Thickness mm.: 7 - Fori/Holes: 12 <ul style="list-style-type: none"> - WVA 15747 (2 pcs.): - Lunghezza/Length mm.: 298 - Altezza fascia/Height band mm.: 80 - Spessore/Thickness mm.: 7 - Fori/Holes: 14 | WVA 15746 (15733) WVA 15747 (15732) 1906230 1906231 1906232 | AS5012 AS5012+10 AS5012+20 |

Senza rivetti/Without rivets



Connessione / Connected:  R6200

| | | | |
|---|--|---|--------------------------------------|
| 55.10 60.10 65.10 70.10 75.10 OM 60 OM 65 OM 70 OM 75 | <ul style="list-style-type: none"> - Qty set: 4 - Rivetti/Rivet: 6 x 15 T12 - Ø tamburo freno/brake drum mm.: 325 <ul style="list-style-type: none"> - WVA 17408 (2 pcs.): - Lunghezza/Length mm.: 255 - Altezza fascia/Height band mm.: 100 - Spessore/Thickness mm.: 8 - Fori/Holes: 12 <ul style="list-style-type: none"> - WVA 17793 (2 pcs.): - Lunghezza/Length mm.: 295 - Altezza fascia/Height band mm.: 100 - Spessore/Thickness mm.: 8 - Fori/Holes: 14 | WVA 17408 WVA 17793 1906233 1906234 1906235 | AS5013+10 AS5013+20 |
|---|--|---|--------------------------------------|

Senza rivetti/Without rivets



Connessione / Connected:  R6200

I riferimenti indicati non sono originali ma perfettamente intercambiabili. I codici originali e le case costruttrici sono indicati a puro titolo informativo
The details described are not original but perfectly interchangeable. The original references and manufacturer names are given for information purposes only.

| Emmerre | Adattabile a / Adaptable to | Dettagli / Detail | Applicazioni / Applications |
|--|-----------------------------|---|---|
| AS5054 AS5054+10 | WVA 15174 WVA 15150 | <p>- Qty set: 4 - Rivetti/Rivet: 6 x 20 T12 - Ø tamburo freno/brake drum mm.: 325</p> <p>- WVA 15174 (2 pcs.): - Lunghezza/Lenght mm.: 338 - Altezza fascia/Height band mm.: 80 - Spessore/Thickness mm.: 7 - Fori/Holes: 16</p> <p>- WVA 15150 (2 pcs.): - Lunghezza/Lenght mm.: 252 - Altezza fascia/Height band mm.: 80 - Spessore/Thickness mm.: 7 - Fori/Holes: 12</p> <p>Senza rivetti/ Without rivets</p> | Cerbiatto Daino Leoncino Lupetto |
| Connessione / Connected:  R6201 | | | |
| AS5055 AS5055+10 AS5055+20 | WVA 17379 WVA 17378 | <p>- Qty set: 4 - Rivetti/Rivet: 6 x 20 T12 - Ø tamburo freno/brake drum mm.: 325</p> <p>- WVA 17379 (2 pcs.): - Lunghezza/Lenght mm.: 336 - Altezza fascia/Height band mm.: 100 - Spessore/Thickness mm.: 8 - Fori/Holes: 16</p> <p>- WVA 17378 (2 pcs.): - Lunghezza/Lenght mm.: 250 - Altezza fascia/Height band mm.: 100 - Spessore/Thickness mm.: 8 - Fori/Holes: 12</p> <p>Senza rivetti/ Without rivets</p> | Daino 35-40 Leoncino |
| Connessione / Connected:  R6201 | | | |



**CEPPI FRENO E RIVETTI
BRAKE LININGS AND RIVETS
GARNITURES DE FREIN ET RIVETS
BREMSKLOETZE UND NIETEN
ТОРМОЗНЫЕ НАКЛАДКИ И ЗАКЛЕПКИ
FORROS DE FRENO Y REMACHES**

EMMERRE
spare parts for trucks and trailers

IVECO

| Applicazioni / Applications | Dettagli / Detail | Adattabile a / Adaptable to | Emmerre |
|-----------------------------|---|-----------------------------|---|
| Tigrotto 55 | <ul style="list-style-type: none"> - Qty set: 4 - Rivetti/Rivet: 6 x 15 T12 - Ø tamburo freno/brake drum mm.: 396 - WVA 17051 (2 pcs.): - Lunghezza/Length mm.: 418 - Altezza fascia/Height band mm.: 100 - Spessore/Thickness mm.: 8 - Fori/Holes: 16 - WVA 17050 (2 pcs.): - Lunghezza/Length mm.: 311 - Altezza fascia/Height band mm.: 100 - Spessore/Thickness mm.: 8 - Fori/Holes: 12 <p>Senza rivetti/Without rivets</p> | WVA 17051 WVA 17050 | AS5058 AS5058+10 AS5058+20 |



| Connessione / Connected:  R6200 | | | |
|--|---|--|-----------------------------------|
| OM 80 OM 90 | <ul style="list-style-type: none"> - Qty set: 4 - Rivetti/Rivet: 6 x 15 T12 - Ø tamburo freno/brake drum mm.: 400 - WVA 17769 (2 pcs.): - Lunghezza/Length mm.: 316 - Altezza fascia/Height band mm.: 100 - Spessore/Thickness mm.: 8 - Fori/Holes: 12 - WVA 17770 (2 pcs.): - Lunghezza/Length mm.: 370 - Altezza fascia/Height band mm.: 100 - Spessore/Thickness mm.: 8 - Fori/Holes: 14 <p>Senza rivetti/Without rivets</p> | WVA 17769 (17792) WVA 17770 (17794) 1906304 1906301 1906305 1903253 7160118 7160125 | AS5014 AS5014+10 |



Ceppl Freno
Brake Linings

| Emmerre | Adattabile a / Adaptable to | Dettagli / Detail | Applicazioni / Applications |
|------------------|-----------------------------|---------------------------------------|-----------------------------|
| AC2171 | WVA 17238 | - Qty set: 8 | 9.100/150 |
| AC2171+10 | 81502216073 | - Rivetti/Rivet: 8 x 18 T16 | M 90 |
| AC2171+20 | 81502216089 | - Ø tamburo freno/brake drum mm.: 410 | F 90 |
| | | - WVA 17238 (8 pcs.): | F 2000 |
| | | - Lunghezza/Lenght mm.: 178 | TGA |
| | | - Altezza fascia/Height band mm.: 143 | |
| | | - Spessore/Thickness mm.: 17/11,8 | |
| | | - Fori/Holes: 8 | |

Senza rivetti / Without rivets



Connessione / Connected:



R6001

| | | | |
|------------------|-------------|---------------------------------------|--------|
| AC2124 | WVA 19494 | - Qty set: 8 | M 90 |
| AC2124+10 | 81502216087 | - Rivetti/Rivet: 8 x 18 T16 | M 2000 |
| AC2124+20 | | - Ø tamburo freno/brake drum mm.: 410 | F 90 |
| | | - WVA 19494 (8 pcs.): | |
| | | - Lunghezza/Lenght mm.: 178 | |
| | | - Altezza fascia/Height band mm.: 163 | |
| | | - Spessore/Thickness mm.: 17/11,8 | |
| | | - Fori/Holes: 9 | |

Con rivetti / With rivets



Connessione / Connected:



R6001

CEPPI FRENO E RIVETTI
BRAKE LININGS AND RIVETS
GARNITURES DE FREIN ET RIVETS
BREMSKLOETZE UND NIETEN
ТОРМОЗНЫЕ НАКЛАДКИ И ЗАКЛЕПКИ
FORROS DE FRENO Y REMACHES

EMMERRE
 spare parts for trucks and trailers

MAN

| Applicazioni / Applications | Dettagli / Detail | Adattabile a / Adaptable to | Emmerre |
|----------------------------------|--|---|---|
| F 90 F 2000 M 90 M 2000 | - Qty set: 8 - Rivetti/Rivet: 8 x 18 T16 - Ø tamburo freno/brake drum mm.: 410 - WVA 19496 (8 pcs.): - Lunghezza/Lenght mm.: 178 - Altezza fascia/Height band mm.: 223 - Spessore/Thickness mm.: 17/11,8 - Fori/Holes: 10 | WVA 19496 81502216081 81502216101 81502210860 81502216083 81502216103 81502216104 | AC2125 AC2125+10 AC2125+20 |

Con rivetti/With rivets

Omologazione/Homologation Nr.:
E11 90R-02B01229/26975



Connessione / Connected:  R6001

| | | | |
|------------------------|--|--|---|
| M 90 F 90 F 2000 | - Qty set: 8 - Rivetti/Rivet: 8 x 18 T16 - Ø tamburo freno/brake drum mm.: 410 - WVA 19495 (8 pcs.): - Lunghezza/Lenght mm.: 178 - Altezza fascia/Height band mm.: 183 - Spessore/Thickness mm.: 17/11,8 - Fori/Holes: 10 | WVA 19495 81502216077 81502216099 81502216100 | AC2126 AC2126+10 AC2126+20 |
|------------------------|--|--|---|

Con rivetti/With rivets

Omologazione/Homologation Nr.:
E9 90R-02B1223/2282



Connessione / Connected:  R6001

I riferimenti indicati non sono originali ma perfettamente intercambiabili. I codici originali e le case costruttrici sono indicati a puro titolo informativo
 The details described are not original but perfectly interchangeable. The original references and manufacturer names are given for information purposes only.

| Emmerre | Adattabile a / <i>Adaptable to</i> | Dettagli / <i>Detail</i> | Applicazioni / <i>Applications</i> |
|------------------|------------------------------------|--|--|
| AC2124 | WVA 19494 | - Qty set: 8 - Rivetti/ <i>Rivet</i> : 8 x 18 T16 - Ø tamburo freno/ <i>brake drum</i> mm.: 410 | Series SK Series MK Series NG Atego Atego II |
| AC2124+10 | 6214210810 | | |
| AC2124+20 | 6214210410 | | |
| | 6214211110 | - WVA 19494 (8 pcs.); - Lunghezza/ <i>Lenght</i> mm.: 178 - Altezza fascia/ <i>Height band</i> mm.: 163 - Spessore/ <i>Thickness</i> mm.: 17/11,8 - Fori/ <i>Holes</i> : 9 | |
| | 6214210910 | | |

Con rivetti/With rivets



Connessione / *Connected*:



R6001

| | | | |
|------------------|------------|---|--|
| AC2126 | WVA 19495 | - Qty set: 8 - Rivetti/ <i>Rivet</i> : 8 x 18 T16 - Ø tamburo freno/ <i>brake drum</i> mm.: 410 | Series SK Series MK Series NG Atego Axor II Arocs Actros Actros MP2 Actros MP3 |
| AC2126+10 | 6174231330 | | |
| AC2126+20 | 6174231430 | - WVA 19495 (8 pcs.); - Lunghezza/ <i>Lenght</i> mm.: 178 - Altezza fascia/ <i>Height band</i> mm.: 183 - Spessore/ <i>Thickness</i> mm.: 17/11,8 - Fori/ <i>Holes</i> : 10 | |
| | 6594234010 | | |

Con rivetti/With rivets

Omologazione/Homologation Nr.:
E9 90R-02B1223/2282



Connessione / *Connected*:



R6001

CEPPI FRENO E RIVETTI
BRAKE LININGS AND RIVETS
GARNITURES DE FREIN ET RIVETS
BREMSKLOETZE UND NIETEN
ТОРМОЗНЫЕ НАКЛАДКИ И ЗАКЛЕПКИ
FORROS DE FRENO Y REMACHES

EMMERRE
 spare parts for trucks and trailers

MERCEDES

| Applicazioni / Applications | Dettagli / Detail | Adattabile a / Adaptable to | Emmerre |
|-----------------------------|---------------------------------------|-----------------------------|------------------|
| Series SK | - Qty set: 8 | WVA 19496 | AC2125 |
| Series MK | - Rivetti/Rivet: 8 x 18 T16 | | AC2125+10 |
| Atego | - Ø tamburo freno/brake drum mm.: 410 | 6594233710 | AC2125+20 |
| Axor II | | | |
| Arocs | - WVA 19496 (8 pcs.): | 6594232910 | |
| Actros | - Lunghezza/Lenght mm.: 178 | | |
| Actros MP2 | - Altezza fascia/Height band mm.: 223 | 6594233810 | |
| Actros MP3 | - Spessore/Thickness mm.: 17/11,8 | | |
| | - Fori/Holes: 10 | | |

Con rivetti/With rivets

Omologazione/Homologation Nr.:
E11 90R-02B01229/26979



Connessione / Connected:  R6001

| | | | |
|-----|---------------------------------------|------------|------------------|
| 407 | - Qty set: 4 | WVA 15743 | AS5021 |
| 409 | - Rivetti/Rivet: 5 x 12 T10 | WVA 15742 | AS5021+10 |
| 410 | - Ø tamburo freno/brake drum mm.: 270 | | |
| 507 | | 6114231010 | |
| 508 | - WVA 15743 (2 pcs.): | 6114209020 | |
| 510 | - Lunghezza/Lenght mm.: 243 | | |
| 608 | - Altezza fascia/Height band mm.: 80 | | |
| 613 | - Spessore/Thickness mm.: 8 | | |
| | - Fori/Holes: 14 | | |
| | - WVA 15742 (2 pcs.): | | |
| | - Lunghezza/Lenght mm.: 210 | | |
| | - Altezza fascia/Height band mm.: 80 | | |
| | - Spessore/Thickness mm.: 8 | | |
| | - Fori/Holes: 12 | | |

Senza rivetti/Without rivets



Connessione / Connected:  R6207

I riferimenti indicati non sono originali ma perfettamente intercambiabili. I codici originali e le case costruttrici sono indicati a puro titolo informativo
 The details described are not original but perfectly interchangeable. The original references and manufacturer names are given for information purposes only.

| Emmerre | Adattabile a / Adaptable to | Dettagli / Detail | Applicazioni / Applications |
|-------------------------------------|--|--|--|
| AS5038 AS5038+10 | WVA 19199 WVA 19049 5000224295 5000288514 5000288515 5001859276 | - Qty set: 4 - Rivetti/Rivet: 6 x 15 T12 - Ø tamburo freno/brake drum mm.: 414 - WVA 19199 (2 pcs.): - Lunghezza/Length mm.: 285 - Altezza fascia/Height band mm.: 150 - Spessore/Thickness mm.: 12,7 - Fori/Holes: 22 - WVA 19049 (2 pcs.): - Lunghezza/Length mm.: 344 - Altezza fascia/Height band mm.: 150 - Spessore/Thickness mm.: 12,7 - Fori/Holes: 26 | GR 320-302A/B 350 A/B GR190-191 A/B 230GRH GR231 A/B-232GRH 235R - TBH280 TR305 A/D TR320 TR350 GRH305-350 MIDLINER MANAGER |
| Senza rivetti/Without rivets | | | |



Connessione / Connected:  R6200

| | | | |
|-------------------------------------|---|---|-------------------|
| AC1866 AC1866+10 | WVA 19463 5000288510 5000288511 | - Qty set: 4 - Rivetti/Rivet: 8 x 16 T15 - Ø tamburo freno/brake drum mm.: 414 - WVA 19463 (4 pcs.): - Lunghezza/Length mm.: 370 - Altezza fascia/Height band mm.: 175 - Spessore/Thickness mm.: 13,5 - Fori/Holes: 18 | G260-R310 R370 |
| Senza rivetti/Without rivets | | | |



Connessione / Connected:  R6000

CEPPI FRENO E RIVETTI
BRAKE LININGS AND RIVETS
GARNITURES DE FREIN ET RIVETS
BREMSKLOETZE UND NIETEN
ТОРМОЗНЫЕ НАКЛАДКИ И ЗАКЛЕПКИ
FORROS DE FRENO Y REMACHES

EMMERRE
 spare parts for trucks and trailers

RENAULT

| Applicazioni / Applications | Dettagli / Detail | Adattabile a / Adaptable to | Emmerre |
|--|--|-----------------------------|-----------------------------------|
| Series G Major R Midliner M 180/200/210 230/250 Magnum AE 420/430/470 520/560 | - Qty set: 8 - Rivetti/Rivet: 8 x 18 T16 - Ø tamburo freno/brake drum mm.: 414 | WVA 19934 5000855105 | AC2130 AC2130+20 |
| | - WVA 19934 (8 pcs.): - Lunghezza/Length mm.: 185 - Altezza fascia/Height band mm.: 150 - Spessore/Thickness mm.: 18,5 - Fori/Holes: 8 | 5000288513 5000288512 | |

Senza rivetti / Without rivets



Connessione / Connected:



R6001

| | | | |
|--|--|---------------------------------------|---|
| Series G Major R Maxter Manager Midliner Kerax Magnum AE 380/420/430 470/500/520/ 560 | - Qty set: 8 - Rivetti/Rivet: 8 x 18 T16 - Ø tamburo freno/brake drum mm.: 414 | WVA 19935 5000288508 5001855107 | AC2131 AC2131+10 AC2131+20 |
| | - WVA 19935 (8 pcs.): - Lunghezza/Length mm.: 185 - Altezza fascia/Height band mm.: 175 - Spessore/Thickness mm.: 18,5 - Fori/Holes: 8 | 5000288509 5000821818 | |

Senza rivetti / Without rivets



Connessione / Connected:



R6001

I riferimenti indicati non sono originali ma perfettamente intercambiabili. I codici originali e le case costruttrici sono indicati a puro titolo informativo
 The details described are not original but perfectly interchangeable. The original references and manufacturer names are given for information purposes only.

| Emmerre | Adattabile a / Adaptable to | Dettagli / Detail | Applicazioni / Applications |
|------------------|-----------------------------|---------------------------------------|-----------------------------|
| AC2132 | WVA 19187 | - Qty set: 8 | Magnum |
| AC2132+10 | 5001860048 | - Rivetti/Rivet: 8 x 18 T16 | AE 385/390/420 |
| AC2132+20 | 5001855122 | - Ø tamburo freno/brake drum mm.: 414 | 430/470/520/ 560 |
| | | - WVA 19187 (8 pcs.): | Premium |
| | | - Lunghezza/Lenght mm.: 185 | 210/250/270/ |
| | | - Altezza fascia/Height band mm.: 220 | 300/320/340/ |
| | | - Spessore/Thickness mm.: 18,5 | 370/385/400/ |
| | | - Fori/Holes: 8 | 420 |

Con rivetti/With rivets



Connessione / Connected:



R6001

CEPPI FRENO E RIVETTI
BRAKE LININGS AND RIVETS
GARNITURES DE FREIN ET RIVETS
BREMSKLOETZE UND NIETEN
ТОРМОЗНЫЕ НАКЛАДКИ И ЗАКЛЕПКИ
FORROS DE FRENO Y REMACHES

EMMERRE
 spare parts for trucks and trailers

ROR

| Applicazioni / Applications | Dettagli / Detail | Adattabile a / Adaptable to | Emmerre |
|-----------------------------|---|--|-----------------------------------|
| Axle | <ul style="list-style-type: none"> - Qty set: 8 - Rivetti/Rivet: 6,3 x 17,5 T12 - Ø tamburo freno/brake drum mm.: 311 <ul style="list-style-type: none"> - WVA 19604 (4 pcs.): - Lunghezza/Length mm.: 125 - Altezza fascia/Height band mm.: 190 - Spessore/Thickness mm.: 15/8 - Fori/Holes: 10 <ul style="list-style-type: none"> - WVA 19605 (4 pcs.): - Lunghezza/Length mm.: 158 - Altezza fascia/Height band mm.: 190 - Spessore/Thickness mm.: 15/12 - Fori/Holes: 10 | WVA 19604 WVA 19605 21020776 | AS5051 AS5051+10 |

Senza rivetti/Without rivets





| Connessione / Connected:  R6007 | |
|--|--|
| Axle | <ul style="list-style-type: none"> - Qty set: 8 - Rivetti/Rivet: 6,3 x 18 T12 - Ø tamburo freno/brake drum mm.: 350 <ul style="list-style-type: none"> - WVA 19908 (4 pcs.): - Lunghezza/Length mm.: 151 - Altezza fascia/Height band mm.: 200 - Spessore/Thickness mm.: 18/10 - Fori/Holes: 10 <ul style="list-style-type: none"> - WVA 19909 (4 pcs.): - Lunghezza/Length mm.: 151 - Altezza fascia/Height band mm.: 200 - Spessore/Thickness mm.: 18/14 - Fori/Holes: 10 |

Senza rivetti/Without rivets



Ceppi Freno
 Brake Linings

| Emmerre | Adattabile a / Adaptable to | Dettagli / Detail | Applicazioni / Applications |
|---|--|--|--|
| AS5050 AS5050+10 AS5050+20 AS5050+30 | WVA 19036 WVA 19037 21200790 | - Qty set: 8 - Rivetti/Rivet: 6,3 x 18 T12 - Ø tamburo freno/brake drum mm.: 419 - WVA 19036 (4 pcs.): - Lunghezza/Lenght mm.: 190 - Altezza fascia/Height band mm.: 178 - Spessore/Thickness mm.: 18/14,5 - Fori/Holes: 12 - WVA 19037 (4 pcs.): - Lunghezza/Lenght mm.: 195 - Altezza fascia/Height band mm.: 178 - Spessore/Thickness mm.: 18/10 - Fori/Holes: 12 Con rivetti/With rivets | Axle |
|  | | | Connessione / Connected:  R6007 |

| | | | |
|---|------------------------|---|--|
| AS5015 | WVA 19613 WVA 19614 | - Qty set: 8 - Rivetti/Rivet: 5 x 15 T12 - Ø tamburo freno/brake drum mm.: 419 - WVA 19613 (4 pcs.): - Lunghezza/Lenght mm.: 190 - Altezza fascia/Height band mm.: 178 - Spessore/Thickness mm.: 18,5/15 - Fori/Holes: 16 - WVA 19614 (4 pcs.): - Lunghezza/Lenght mm.: 195 - Altezza fascia/Height band mm.: 178 - Spessore/Thickness mm.: 18,5/10,5 - Fori/Holes: 16 Senza rivetti/Without rivets | Axle |
|  | | | Connessione / Connected:  R6018 |

CEPPI FRENO E RIVETTI
BRAKE LININGS AND RIVETS
GARNITURES DE FREIN ET RIVETS
BREMSKLOETZE UND NIETEN
ТОРМОЗНЫЕ НАКЛАДКИ И ЗАКЛЕПКИ
FORROS DE FRENO Y REMACHES

EMMERRE
 spare parts for trucks and trailers

ROR

| Applicazioni / Applications | Dettagli / Detail | Adattabile a / Adaptable to | Emmerre |
|-----------------------------|---|-----------------------------|---|
| Axle | <ul style="list-style-type: none"> - Qty set: 8 - Rivetti/Rivet: 6,3 x 16 T12 - Ø tamburo freno/brake drum mm.: 419 - WVA 19030 (4 pcs.): <ul style="list-style-type: none"> - Lunghezza/Lenght mm.: 189 - Altezza fascia/Height band mm.: 178 - Spessore/Thickness mm.: 21/16,5 - Fori/Holes: 12 - WVA 19033 (4 pcs.): <ul style="list-style-type: none"> - Lunghezza/Lenght mm.: 195 - Altezza fascia/Height band mm.: 178 - Spessore/Thickness mm.: 21/12 - Fori/Holes: 12 <p>Senza rivetti/Without rivets</p> | WVA 19030 WVA 19033 | AS5068 AS5068+10 AS5068+20 |



| | | | |
|--|---|------------------------|---|
| Connessione / Connected:  R6006 | <ul style="list-style-type: none"> - Qty set: 8 - Rivetti/Rivet: 6,3 x 17,5 T12 - Ø tamburo freno/brake drum mm.: 419 - WVA 19365 (4 pcs.): <ul style="list-style-type: none"> - Lunghezza/Lenght mm.: 195 - Altezza fascia/Height band mm.: 203 - Spessore/Thickness mm.: 18/10,5 - Fori/Holes: 12 - WVA 19366 (4 pcs.): <ul style="list-style-type: none"> - Lunghezza/Lenght mm.: 189 - Altezza fascia/Height band mm.: 203 - Spessore/Thickness mm.: 19/15 - Fori/Holes: 12 <p>Senza rivetti/Without rivets</p> | WVA 19365 WVA 19366 | AS5056 AS5056+10 AS5056+20 |
|--|---|------------------------|---|



| | | |
|--|--|------------|
| Connessione / Connected:  R6007 | I riferimenti indicati non sono originali ma perfettamente intercambiabili. I codici originali e le case costruttrici sono indicati a puro titolo informativo The details described are not original but perfectly interchangeable. The original references and manufacturer names are given for information purposes only. | 499 |
|--|--|------------|

| Emmerre | Adattabile a / Adaptable to | Dettagli / Detail | Applicazioni / Applications |
|------------------|-----------------------------|---------------------------------------|-----------------------------|
| AS5004 | WVA 19370 | - Qty set: 8 | Axle |
| AS5004+10 | WVA 19369 | - Rivetti/Rivet: 6,3 x 18 T12 | |
| AS5004+20 | 21200794 | - Ø tamburo freno/brake drum mm.: 419 | |
| | 21200795 | - Fascia/Band 219 - Ø mm. 419 | |
| | | - WVA 19370 (4 pcs.): | |
| | | - Lunghezza/Length mm.: 190 | |
| | | - Altezza fascia/Height band mm.: 219 | |
| | | - Spessore/Thickness mm.: 18,5/15 | |
| | | - Fori/Holes: 12 | |
| | | - WVA 19369 (4 pcs.): | |
| | | - Lunghezza/Length mm.: 192 | |
| | | - Altezza fascia/Height band mm.: 219 | |
| | | - Spessore/Thickness mm.: 18/10 | |
| | | - Fori/Holes: 12 | |
| | | Senza rivetti/Without rivets | |



Connessione / Connected:



R6007

CEPPI FRENO E RIVETTI
BRAKE LININGS AND RIVETS
GARNITURES DE FREIN ET RIVETS
BREMSKLOETZE UND NIETEN
ТОРМОЗНЫЕ НАКЛАДКИ И ЗАКЛЕПКИ
FORROS DE FRENO Y REMACHES

EMMERRE
 spare parts for trucks and trailers

SAF

| Applicazioni / Applications | Dettagli / Detail | Adattabile a / Adaptable to | Emmerre |
|--|--|---|---|
| Axle KRS RBM - RLBM RLSM - RSM RZM SKRLS 9037/9042 SKRLZ 9030/11030 SKRS 9042 SKRZ 9037/9042/ 11030/11037 11242 | - Qty set: 8 - Rivetti/Rivet: 8 x 16 T16 - Ø tamburo freno/brake drum mm.: 420 | WVA 19032 3057301200 3057391210 3057391220 | AC1150 AC1150+10 AC1150+20 AC1150+30 |

Con indicatore usura foro/With wear indicator hole

Con rivetti/With rivets

Omologazione/Homologation Nr.:

E9 90R-02B1223/2323

E11 90R-02B01229/27011



| Connesione / Connected: | R6000 |
|--|--|
| Axle KRS RBM - RLBM RLSM - RSM RZM SKRLS 9037/9042 SKRLZ 9030/11030 SKRS 9042 SKRZ 9037/9042/ 11030/11037 11242 | - Qty set: 8 - Rivetti/Rivet: 8 x 16 T16 - Ø tamburo freno/brake drum mm.: 420 |

- WVA 19283 (4 pcs.):
- Lunghezza/Lenght mm.: 189
- Altezza fascia/Height band mm.: 178
- Spessore/Thickness mm.: 20/17
- Fori/Holes: 8

- WVA 19284 (4 pcs.):
- Lunghezza/Lenght mm.: 194
- Altezza fascia/Height band mm.: 178
- Spessore/Thickness mm.: 20/12,5
- Fori/Holes: 8

Con rivetti/With rivets

Omologazione/Homologation Nr.:

E11 90R-02B01229/27011



| Connesione / Connected: | R6000 |
|-------------------------|-------|
|-------------------------|-------|

I riferimenti indicati non sono originali ma perfettamente intercambiabili. I codici originali e le case costruttrici sono indicati a puro titolo informativo
 The details described are not original but perfectly interchangeable. The original references and manufacturer names are given for information purposes only.

| Emmerre | Adattabile a / Adaptable to | Dettagli / Detail | Applicazioni / Applications |
|------------------|-----------------------------|---------------------------------------|-----------------------------|
| AC1394 | WVA 19094 | - Qty set: 8 | Axle |
| AC1394+10 | 3057391300 | - Rivetti/Rivet: 8 x 16 T16 | |
| AC1394+20 | 3057391310 | - Ø tamburo freno/brake drum mm.: 420 | |
| AC1394+30 | 3057391320 | - WVA 19094 (8 pcs.); | |
| | | - Lunghezza/Lenght mm.: 205 | |
| | | - Altezza fascia/Height band mm.: 200 | |
| | | - Spessore/Thickness mm.: 17,5/11,5 | |
| | | - Fori/Holes: 10 | |

Con rivetti/With rivets

Omologazione/Homologation Nr.:

E9 90R-02B1223/1073

E11 90R-02B01229/27012



Connessione / Connected:



R6000

**CEPPI FRENO E RIVETTI
BRAKE LININGS AND RIVETS
GARNITURES DE FREIN ET RIVETS
BREMSKLOETZE UND NIETEN
ТОРМОЗНЫЕ НАКЛАДКИ И ЗАКЛЕПКИ
FORROS DE FRENO Y REMACHES**

EMMERRE
spare parts for trucks and trailers

SMB

| Applicazioni / Applications | Dettagli / Detail | Adattabile a / Adaptable to | Emmerre |
|-----------------------------|---|-----------------------------|---------------|
| Axle | <ul style="list-style-type: none"> - Qty set: 8 - Rivetti/Rivet: 5 x 15 T12 - Ø tamburo freno/brake drum mm.: 419 - WVA 19613 (4 pcs.): <ul style="list-style-type: none"> - Lunghezza/Lenght mm.: 190 - Altezza fascia/Height band mm.: 178 - Spessore/Thickness mm.: 18,5/15 - Fori/Holes: 16 - WVA 19614 (4 pcs.): <ul style="list-style-type: none"> - Lunghezza/Lenght mm.: 195 - Altezza fascia/Height band mm.: 178 - Spessore/Thickness mm.: 18,5/10,5 - Fori/Holes: 16 <p>Senza rivetti/Without rivets</p> | WVA 19613 WVA 19614 | AS5015 |



| Connesione / Connected: | | | |
|---|---|------------------------|---|
|  R6018 | | | |
| Axle | <ul style="list-style-type: none"> - Qty set: 8 - Rivetti/Rivet: 5 x 16 T12 - Ø tamburo freno/brake drum mm.: 419 - WVA 19557 (4 pcs.): <ul style="list-style-type: none"> - Lunghezza/Lenght mm.: 194 - Altezza fascia/Height band mm.: 203 - Spessore/Thickness mm.: 18,7/11 - Fori/Holes: 16 - WVA 19606 (4 pcs.): <ul style="list-style-type: none"> - Lunghezza/Lenght mm.: 189 - Altezza fascia/Height band mm.: 203 - Spessore/Thickness mm.: 19/15,8 - Fori/Holes: 16 <p>Senza rivetti/Without rivets</p> | WVA 19557 WVA 19606 | AS5063 AS5063+10 AS5063+20 |



| Connesione / Connected: | | | |
|---|--|--|--|
|  R6108 | | | |

I riferimenti indicati non sono originali ma perfettamente intercambiabili. I codici originali e le case costruttrici sono indicati a puro titolo informativo
The details described are not original but perfectly interchangeable. The original references and manufacturer names are given for information purposes only.

| Emmerre | Adattabile a / Adaptable to | Dettagli / Detail | Applicazioni / Applications |
|---------------------------------------|-----------------------------|---------------------------------------|-----------------------------|
| AC2134 | WVA 19932 | - Qty set: 4 | Series 4 |
| AC2134+10 | 551124 | - Rivetti/Rivet: 6,3 x 20 T12 | 94/114/124/ |
| AC2134+20 | 1535249 | - Ø tamburo freno/brake drum mm.: 413 | 144/164 |
| | 1535249 | - WVA 19932 (4 pcs.): | |
| | 1535253 | - Lunghezza/Length mm.: 235 | |
| | | - Altezza fascia/Height band mm.: 203 | |
| | | - Spessore/Thickness mm.: 19 | |
| | | - Fori/Holes: 16 | |
| Con rivetti/With rivets | | | |
| Omologazione/Homologation Nr.: | | | |
| E9 90R-02B1223/2686 | | | |
| E11 90R-02B01229/26973 | | | |



Connessione / Connected:  R6107

| | | | |
|---------------------------------------|-----------|---------------------------------------|-------------|
| AC2135 | WVA 19933 | - Qty set: 4 | Series 4 |
| AC2135+10 | 1535250 | - Rivetti/Rivet: 6,3 x 20 T12 | 94/114/124/ |
| AC2135+20 | 552116 | - Ø tamburo freno/brake drum mm.: 413 | 144/164 |
| | 1535254 | - WVA 19933 (4 pcs.): | |
| | | - Lunghezza/Length mm.: 235 | |
| | | - Altezza fascia/Height band mm.: 254 | |
| | | - Spessore/Thickness mm.: 19 | |
| | | - Fori/Holes: 16 | |
| Con rivetti/With rivets | | | |
| Omologazione/Homologation Nr.: | | | |
| E9 90R-02B1223/2769 | | | |



Connessione / Connected:  R6107

**CEPPI FRENO E RIVETTI
BRAKE LININGS AND RIVETS
GARNITURES DE FREIN ET RIVETS
BREMSKLOETZE UND NIETEN
ТОРМОЗНЫЕ НАКЛАДКИ И ЗАКЛЕПКИ
FORROS DE FRENO Y REMACHES**

EMMERRE
spare parts for trucks and trailers

SCANIA

| Applicazioni / Applications | Dettagli / Detail | Adattabile a / Adaptable to | Emmerre |
|-----------------------------------|--|--------------------------------------|--------------------------------------|
| Series 3 93/113/143 | - Qty set: 4 - Rivetti/Rivet: 6,3 x 20 T12 | WVA 19931 | AC2133 |
| Series 4 94/114/124 144/164 | - Ø tamburo freno/brake drum mm.: 413 - WVA 19931 (4 pcs.): - Lunghezza/Lenght mm.: 235 - Altezza fascia/Height band mm.: 178 - Spessore/Thickness mm.: 19 - Fori/Holes: 16 | 1535248 1535252 552112 | AC2133+10 AC2133+20 |

Senza rivetti/Without rivets



Connessione / Connected:  R6107

| | | | |
|---------------------------|---|---------------------------------------|---|
| Series 2 82/92/112/142 | - Qty set: 8 - Rivetti/Rivet: 6,3 x 18 T12 - Ø tamburo freno/brake drum mm.: 413 - WVA 19393 (8 pcs.): - Lunghezza/Lenght mm.: 195 - Altezza fascia/Height band mm.: 203 - Spessore/Thickness mm.: 19 - Fori/Holes: 12 | WVA 19393 551170 551174 | AC1581 AC1581+10 AC1581+20 |
|---------------------------|---|---------------------------------------|---|

Senza rivetti/Without rivets



Connessione / Connected:  R6107

I riferimenti indicati non sono originali ma perfettamente intercambiabili. I codici originali e le case costruttrici sono indicati a puro titolo informativo
The details described are not original but perfectly interchangeable. The original references and manufacturer names are given for information purposes only.

| Emmerre | Adattabile a / Adaptable to | Dettagli / Detail | Applicazioni / Applications |
|------------------|-----------------------------|---------------------------------------|-----------------------------|
| AC1899+10 | WVA 19075 | - Qty set: 8 | Series 2 |
| AC1899+20 | 551169 | - Rivetti/Rivet: 6,3 x 18 T12 | 82/92/112/142 |
| | 551173 | - Ø tamburo freno/brake drum mm.: 413 | |
| | | - WVA 19075 (8 pcs.): | |
| | | - Lunghezza/Length mm.: 195 | |
| | | - Altezza fascia/Height band mm.: 178 | |
| | | - Spessore/Thickness mm.: 19 | |
| | | - Fori/Holes: 12 | |

Senza rivetti/Without rivets



Connessione / Connected:







R6107

CEPPI FRENO E RIVETTI
BRAKE LININGS AND RIVETS
GARNITURES DE FREIN ET RIVETS
BREMSKLOETZE UND NIETEN
ТОРМОЗНЫЕ НАКЛАДКИ И ЗАКЛЕПКИ
FORROS DE FRENO Y REMACHES

EMMERRE
 spare parts for trucks and trailers

STEYR



| Applicazioni / Applications | Dettagli / Detail | Adattabile a / Adaptable to | Emmerre |
|--|---|-----------------------------|---|
| 19-22-26-32-42S | <ul style="list-style-type: none"> - Qty set: 8 - Rivetti/Rivet: 8 x 18 T16 - Ø tamburo freno/brake drum mm.: 410 - WVA 19495 (8 pcs.): - Lunghezza/Length mm.: 178 - Altezza fascia/Height band mm.: 183 - Spessore/Thickness mm.: 17/11,8 - Fori/Holes: 10 <p>Con rivetti/With rivets</p> <p>Omologazione/Homologation Nr.: E9 90R-02B1223/2282</p>  | WVA 19495 | AC2126 AC2126+10 AC2126+20 |
| Connessione / Connected:  R6001 | <ul style="list-style-type: none"> - Qty set: 8 - Rivetti/Rivet: 8 x 18 T16 - Ø tamburo freno/brake drum mm.: 410 - WVA 19496 (8 pcs.): - Lunghezza/Length mm.: 178 - Altezza fascia/Height band mm.: 223 - Spessore/Thickness mm.: 17/11,8 - Fori/Holes: 10 <p>Con rivetti/With rivets</p> <p>Omologazione/Homologation Nr.: E11 90R-02B01229/26975</p>  | WVA 19496 | AC2125 AC2125+10 AC2125+20 |
| Connessione / Connected:  R6001 | | | |

EMMERRE

spare parts for trucks and trailers

STEYR



CEPPI FRENO E RIVETTI
BRAKE LININGS AND RIVETS
GARNITURES DE FREIN ET RIVETS
BREMSKLOETZE UND NIETEN
ТОРМОЗНЫЕ НАКЛАДКИ И ЗАКЛЕПКИ
FORROS DE FRENO Y REMACHES

| Emmerre | Adattabile a / Adaptable to | Dettagli / Detail | Applicazioni / Applications |
|---|---|--|--|
| AC2199 | WVA 19246 99000330025 52603303200 | - Qty set: 8 - Rivetti/Rivet: 10 x 18 T18 - Ø tamburo freno/brake drum mm.: 410 - WVA 19246 (8 pcs.): - Lunghezza/Lenght mm.: 186 - Altezza fascia/Height band mm.: 185 - Spessore/Thickness mm.: 15 - Fori/Holes: 8 Con rivetti/With rivets | |
| AS5050 AS5050+10 AS5050+20 AS5050+30 | WVA 19036 WVA 19037 | - Qty set: 8 - Rivetti/Rivet: 6,3 x 18 T12 - Ø tamburo freno/brake drum mm.: 419 - WVA 19036 (4 pcs.): - Lunghezza/Lenght mm.: 190 - Altezza fascia/Height band mm.: 178 - Spessore/Thickness mm.: 18/14,5 - Fori/Holes: 12 - WVA 19037 (4 pcs.): - Lunghezza/Lenght mm.: 195 - Altezza fascia/Height band mm.: 178 - Spessore/Thickness mm.: 18/10 - Fori/Holes: 12 Con rivetti/With rivets | Connessione / Connected:  R6004 |
| | | | Connessione / Connected:  R6007 |

CEPPI FRENO E RIVETTI
BRAKE LININGS AND RIVETS
GARNITURES DE FREIN ET RIVETS
BREMSKLOETZE UND NIETEN
ТОРМОЗНЫЕ НАКЛАДКИ И ЗАКЛЕПКИ
FORROS DE FRENO Y REMACHES

EMMERRE
 spare parts for trucks and trailers

TRAILOR

| Applicazioni / Applications | Dettagli / Detail | Adattabile a / Adaptable to | Emmerre |
|--|--|-----------------------------|---|
| | <ul style="list-style-type: none"> - Qty set: 8 - Rivetti/Rivet: 6,3 x 18 T12 - Ø tamburo freno/brake drum mm.: 419 <ul style="list-style-type: none"> - WVA 19036 (4 pcs.): - Lunghezza/Lenght mm.: 190 - Altezza fascia/Height band mm.: 178 - Spessore/Thickness mm.: 18/14,5 - Fori/Holes: 12 <ul style="list-style-type: none"> - WVA 19037 (4 pcs.): - Lunghezza/Lenght mm.: 195 - Altezza fascia/Height band mm.: 178 - Spessore/Thickness mm.: 18/10 - Fori/Holes: 12 <p>Con rivetti/With rivets</p> | WVA 19036 WVA 19037 | AS5050 AS5050+10 AS5050+20 AS5050+30 |
| | <p>Senza rivetti/Without rivets</p> | | |
| Connessione / Connected:  R6007 | <ul style="list-style-type: none"> - Qty set: 8 - Rivetti/Rivet: 5 x 15 T12 - Ø tamburo freno/brake drum mm.: 419 <ul style="list-style-type: none"> - WVA 19613 (4 pcs.): - Lunghezza/Lenght mm.: 190 - Altezza fascia/Height band mm.: 178 - Spessore/Thickness mm.: 18,5/15 - Fori/Holes: 16 <ul style="list-style-type: none"> - WVA 19614 (4 pcs.): - Lunghezza/Lenght mm.: 195 - Altezza fascia/Height band mm.: 178 - Spessore/Thickness mm.: 18,5/10,5 - Fori/Holes: 16 | WVA 19613 WVA 19614 | AS5015 |
| Connessione / Connected:  R6018 | | | |



Cepi Freno
 Brake Linings

| Emmerre | Adattabile a / Adaptable to | Dettagli / Detail | Applicazioni / Applications |
|--|-----------------------------|--|-----------------------------|
| AS5056 AS5056+10 AS5056+20 | WVA 19365 WVA 19366 | - Qty set: 8 - Rivetti/Rivet: 6,3 x 17,5 T12 - Ø tamburo freno/brake drum mm.: 419 - WVA 19365 (4 pcs.); - Lunghezza/Lenght mm.: 195 - Altezza fascia/Height band mm.: 203 - Spessore/Thickness mm.: 18/10,5 - Fori/Holes: 12 - WVA 19386 (4 pcs.); - Lunghezza/Lenght mm.: 189 - Altezza fascia/Height band mm.: 203 - Spessore/Thickness mm.: 19/15 - Fori/Holes: 12 Senza rivetti/ Without rivets | |
| Connessione / Connected:  R6007 | | | |
| AS5063 AS5063+10 AS5063+20 | WVA 19557 WVA 19606 | - Qty set: 8 - Rivetti/Rivet: 5 x 16 T12 - Ø tamburo freno/brake drum mm.: 419 - WVA 19557 (4 pcs.); - Lunghezza/Lenght mm.: 194 - Altezza fascia/Height band mm.: 203 - Spessore/Thickness mm.: 18,7/11 - Fori/Holes: 16 - WVA 19606 (4 pcs.); - Lunghezza/Lenght mm.: 189 - Altezza fascia/Height band mm.: 203 - Spessore/Thickness mm.: 19/15,8 - Fori/Holes: 16 Senza rivetti/ Without rivets | |
| Connessione / Connected:  R6108 | | | |

CEPPI FRENO E RIVETTI
BRAKE LININGS AND RIVETS
GARNITURES DE FREIN ET RIVETS
BREMSKLOETZE UND NIETEN
ТОРМОЗНЫЕ НАКЛАДКИ И ЗАКЛЕПКИ
FORROS DE FRENO Y REMACHES

EMMERRE
 spare parts for trucks and trailers

VOLVO

| Applicazioni / Applications | Dettagli / Detail | Adattabile a / Adaptable to | Emmerre |
|-----------------------------|--|--------------------------------------|---|
| F 6 F 7 | <ul style="list-style-type: none"> - Qty set: 8 - Rivetti/Rivet: 6,3 x 16 T12 - Ø tamburo freno/brake drum mm.: 381 - Anteriore-posteriore/Front-Rear | WVA 19384 WVA 19385 271102 | AS5011 AS5011+10 AS5011+20 |
| | <ul style="list-style-type: none"> - WVA 19384 (6 pcs.): - Lunghezza/Lenght mm.: 190 - Altezza fascia/Height band mm.: 178 - Spessore/Thickness mm.: 18/12 - Fori/Holes: 12 | 272849 271103 | |
| | <ul style="list-style-type: none"> - WVA 19385 (2 pcs.): - Lunghezza/Lenght mm.: 190 - Altezza fascia/Height band mm.: 178 - Spessore/Thickness mm.: 18/12 - Fori/Holes: 14 | 272850 | |
| | <p><u>Rockwell system</u> Senza rivetti/Without rivets</p> | | |



| Connessione / Connected:  R6006 | | | |
|--|--|--------------------------|---|
| F 10 -12 -16 FL 7 -10 - 12 FM 7 - 12 FH 12 - 16 | <ul style="list-style-type: none"> - Qty set: 8 - Rivetti/Rivet: 6,3 x 18 T12 - Ø tamburo freno/brake drum mm.: 410 | WVA 19090 3095177 | AC2137 AC2137+10 AC2137+20 |
| | <ul style="list-style-type: none"> - WVA 19090 (8 pcs.): - Lunghezza/Lenght mm.: 178 - Altezza fascia/Height band mm.: 175 - Spessore/Thickness mm.: 17,7/12,2 - Fori/Holes: 14 | 3095178 3095167 | |
| | <p>Con rivetti/With rivets</p> <p>Omologazione/Homologation Nr.: E11 90R-02B01229/26995</p> | | |



| Connessione / Connected:  R6007 | | | |
|--|--|--|--|
|--|--|--|--|

I riferimenti indicati non sono originali ma perfettamente intercambiabili. I codici originali e le case costruttrici sono indicati a puro titolo informativo
 The details described are not original but perfectly interchangeable. The original references and manufacturer names are given for information purposes only.

EMMERRE

spare parts for trucks and trailers

VOLVO

CEPPI FRENO E RIVETTI
BRAKE LININGS AND RIVETS
GARNITURES DE FREIN ET RIVETS
BREMSKLOETZE UND NIETEN
ТОРМОЗНЫЕ НАКЛАДКИ И ЗАКЛЕПКИ
FORROS DE FRENO Y REMACHES

| Emmerre | Adattabile a / Adaptable to | Dettagli / Detail | Applicazioni / Applications |
|---|-----------------------------|---------------------------------------|---|
| AC2138 | WVA 19071 | - Qty set: 8 | F 10 -12 -16 |
| AC2138+10 | 3095169 | - Rivetti/Rivet: 6,3 x 18 T12 | FL 7 -10 - 12 |
| AC2138+20 | 3095179 | - Ø tamburo freno/brake drum mm.: 410 | FM 7 - 12 |
| | 3093259 | - WVA 19071 (8 pcs.): | FH 12 - 16 |
| | 3095180170 | - Lunghezza/Lenght mm.: 178 | |
| | | - Altezza fascia/Height band mm.: 200 | |
| | | - Spessore/Thickness mm.: 17,7/12,2 | |
| | | - Fori/Holes: 14 | |
| Con rivetti/With rivets | | | |
|  | | | |
| Connessione / Connected: | | |  R6007 |

| | | | |
|--|-----------|---------------------------------------|---|
| AC2139 | WVA 19068 | - Qty set: 8 | |
| AC2139+10 | 3095171 | - Rivetti/Rivet: 6,3 x 18 T12 | |
| AC2139+20 | 3095172 | - Ø tamburo freno/brake drum mm.: 410 | |
| | | - WVA 19068 (8 pcs.): | |
| | | - Lunghezza/Lenght mm.: 178 | |
| | | - Altezza fascia/Height band mm.: 225 | |
| | | - Spessore/Thickness mm.: 17,7/12,2 | |
| | | - Fori/Holes: 14 | |
| Con rivetti/With rivets | | | |
|  | | | |
| Connessione / Connected: | | |  R6007 |

CEPPI FRENO E RIVETTI
BRAKE LININGS AND RIVETS
GARNITURES DE FREIN ET RIVETS
BREMSKLOETZE UND NIETEN
ТОРМОЗНЫЕ НАКЛАДКИ И ЗАКЛЕПКИ
FORROS DE FRENO Y REMACHES

EMMERRE
 spare parts for trucks and trailers

YORK

| Applicazioni / Applications | Dettagli / Detail | Adattabile a / Adaptable to | Emmerre |
|--|--|-----------------------------|---|
| Axle 10 ton | <ul style="list-style-type: none"> - Qty set: 8 - Rivetti/Rivet: 6,3 x 18 T12 - Ø tamburo freno/brake drum mm.: 410 - WVA 19090 (8 pcs.): - Lunghezza/Lenght mm.: 178 - Altezza fascia/Height band mm.: 175 - Spessore/Thickness mm.: 17,7/12,2 - Fori/Holes: 14 <p>Con rivetti/With rivets</p> <p>Omologazione/Homologation Nr.: E11 90R-02B01229/26995</p> | WVA 19090 | AC2137 AC2137+10 AC2137+20 |
|  | | | |
| Connessione / Connected:  R6007 | | | |

| | | | |
|--|--|-----------|---|
| | <ul style="list-style-type: none"> - Qty set: 8 - Rivetti/Rivet: 6,3 x 18 T12 - Ø tamburo freno/brake drum mm.: 410 - WVA 19068 (8 pcs.): - Lunghezza/Lenght mm.: 178 - Altezza fascia/Height band mm.: 225 - Spessore/Thickness mm.: 17,7/12,2 - Fori/Holes: 14 <p>Con rivetti/With rivets</p> | WVA 19068 | AC2139 AC2139+10 AC2139+20 |
|  | | | |
| Connessione / Connected:  R6007 | | | |

I riferimenti indicati non sono originali ma perfettamente intercambiabili. I codici originali e le case costruttrici sono indicati a puro titolo informativo
 The details described are not original but perfectly interchangeable. The original references and manufacturer names are given for information purposes only.

CEPPI FRENO E RIVETTI
BRAKE LININGS AND RIVETS
GARNITURES DE FREIN ET RIVETS
BREMSKLOETZE UND NIETEN
ТОРМОЗНЫЕ НАКЛАДКИ И ЗАКЛЕПКИ
FORROS DE FRENO Y REMACHES

| Emmerre | Adattabile a / Adaptable to | Dettagli / Detail | Qtà x Kg / Qty x Kg |
|--------------|-----------------------------|-----------------------------------|---------------------|
| R6000 | -- | - Acciaio/Steel | 188 |
| R6001 | | - Rivetti tubolari/Tubular rivets | 185 |
| R6002 | | - Testa piatta/Flat head 90° | 175 |
| R6003 | | Shaft Ø 8-L 16-H.15,5 | 178 |
| R6004 | | Shaft Ø 8-L 18-H.15,5 | 154 |
| R6005 | | Shaft Ø 8-L 20-H.15,5 | 146 |
| R6010 | | Shaft Ø 8-L 22-H.15,5 | 190 |
| | | Shaft Ø 10-L 18-H.18 | |
| | | Shaft Ø 10-L 20-H.18 | |
| | | Shaft Ø 8-L 22-H.13,5 | |



| | | | |
|--------------|----|-----------------------------------|-----|
| R6009 | -- | - Acciaio/Steel | 370 |
| R6006 | | - Rivetti tubolari/Tubular rivets | 326 |
| R6007 | | - Testa conica/Conical head 150° | 307 |
| R6008 | | Shaft Ø 6,3-L 14,5-H.12 | 276 |
| | | Shaft Ø 6,3-L 16-H.12 | 195 |
| | | Shaft Ø 6,3-L 17,5-H.12 | |
| | | Shaft Ø 6,3-L 20-H.12 | |
| | | Shaft Ø 6,6-L 18-H.12 | |



**CEPPI FRENO E RIVETTI
BRAKE LININGS AND RIVETS
GARNITURES DE FREIN ET RIVETS
BREMSKLOETZE UND NIETEN
ТОРМОЗНЫЕ НАКЛАДКИ И ЗАКЛЕПКИ
FORROS DE FRENO Y REMACHES**

| Qtà x Kg / Qty x Kg | Dettagli / Detail | Adattabile a / Adaptable to | Emmerre |
|--|--|-----------------------------|--|
| 196 150 133 120 351 130 | <p>- Acciaio/Steel - Rivetti semi tubolari/<i>Semi-Tubular rivets</i> - Testa piatta/<i>Flat head 90°</i></p> <p>Shaft Ø 6,3-L 20-H.12 Shaft Ø 8-L 16-H.15,5 Shaft Ø 8-L 18-H.15,5 Shaft Ø 8-L 20-H.15,5 Shaft Ø 5-L 16-H.12 Shaft Ø 10-L 18-H.17</p> | -- | <p>R6107 R6100 R6101 R6102 R6108 R6109</p> |
| 330 261 245 216 208 | <p>- Acciaio/Steel - Rivetti semi tubolari/<i>Semi-Tubular rivets</i> - Testa conica/<i>Conical head 150°</i></p> <p>Shaft Ø 5-L 16-H.12 Shaft Ø 6,3-L 14,5-H.12 Shaft Ø 6,3-L 16-H.12 Shaft Ø 6,3-L 17,5-H.12 Shaft Ø 6,3-L 19-H.12</p> | -- | <p>R6018 R6103 R6104 R6105 R6106</p> |



CEPPI FRENO E RIVETTI
BRAKE LININGS AND RIVETS
GARNITURES DE FREIN ET RIVETS
BREMSKLOETZE UND NIETEN
ТОРМОЗНЫЕ НАКЛАДКИ И ЗАКЛЕПКИ
FORROS DE FRENO Y REMACHES

| Emmerre | Adattabile a / <i>Adaptable to</i> | Dettagli / <i>Detail</i> | Qtà x Kg / <i>Qty x Kg</i> |
|--------------|------------------------------------|---|----------------------------|
| R6200 | -- | - Alluminio/Aluminium | 657 |
| R6201 | | - Rivetti semi tubolari/ <i>Semi-Tubular rivets</i> | 560 |
| R6202 | | - Testa piatta/ <i>Flat head 90°</i> | 395 |
| R6203 | | Shaft Ø 6-L 15-H.12 | 333 |
| R6204 | | Shaft Ø 6-L 20-H.12 | 310 |
| R6205 | | Shaft Ø 8-L 16-H.16 | 285 |
| R6206 | | Shaft Ø 8-L 18-H.16 | 275 |
| R6207 | | Shaft Ø 8-L 20-H.16 | 670 |
| | | Shaft Ø 8-L 23-H.13 | |
| | | Shaft Ø 8-L 23-H.16 | |
| | | Shaft Ø 5-L 12-H.10 | |



| | | | |
|--------------|----|---|-----|
| R6300 | -- | - Ottone/Brass | 195 |
| R6301 | | - Rivetti tubolari/ <i>Tubular rivets</i> | 175 |
| R6302 | | - Testa piatta/ <i>Flat head 90°</i> | 170 |
| R6303 | | Shaft Ø 8-L 16-H.15,5 | 152 |
| R6304 | | Shaft Ø 8-L 18-H.15,5 | 350 |
| | | Shaft Ø 8-L 20-H.15,5 | |
| | | Shaft Ø 8-L 22-H.15,5 | |
| | | Shaft Ø 5-L 16-H.12 | |



**CEPPI FRENO E RIVETTI
BRAKE LININGS AND RIVETS
GARNITURES DE FREIN ET RIVETS
BREMSKLOETZE UND NIETEN
ТОРМОЗНЫЕ НАКЛАДКИ И ЗАКЛЕПКИ
FORROS DE FRENO Y REMACHES**

| Qtà x Kg / Qty x Kg | Dettagli / Detail | Adattabile a / Adaptable to | Emmerre |
|---------------------------------|---|-----------------------------|---|
| 245 215 185 365 190 | <ul style="list-style-type: none"> - Ottone/Brass - Rivetti semi tubolari/<i>Semi-Tubular rivets</i> - Testa conica/<i>Conical head 150°</i> <p>Shaft Ø 6,3-L 14,5-H.12 Shaft Ø 6,3-L 17,5-H.12 Shaft Ø 6,3-L 20-H.12 Shaft Ø 6-L 12-H.10 Shaft Ø 6,6-L 18-H.12</p> | -- | <p>R6400 R6401 R6402 R6403 R6405</p> |
| 146 185 155 | <ul style="list-style-type: none"> - Rame/Copper - Rivetti tubolari/<i>Tubular rivets</i> - Testa conica/<i>Conical head 150°</i> <p>Shaft Ø 10-L 18-H.18 Shaft Ø 6,3-L 19-H.12 Shaft Ø 8-L 20-H.16</p> | -- | <p>R6500 R6501 R6502</p> |



Emmerre

Adattabile a / *Adaptable to*

Dettagli / *Detail*

Qtà x Kg / *Qty x Kg*

R6503

--

- **Rame/Copper**

260

- Rivetti tubolari / *Tubular rivets*
 - Testa piatta / *Flat head 90°*

Shaft Ø 5-L 18-H.12





INDICATORI USURA FRENO

WEAR INDICATORS
INDICATEURS D'USURE
VERSCHLEISSANZEIGER
ДАТЧИКИ ИЗНОСА
INDICADOR DE DESGASTE

BRAKE PARTS MANUFACTURER
TECHNO[®]
BRAKE COVER





NEWS

| Emmerre | Descrizione/Description | Adattabile/Adaptable to | Pagina/Page |
|---------------|---|-------------------------|----------------|
| 960492 | KIT INDICATORI USURA FRENO / SET OF WEAR INDICATORS | BPW | 519 |
| 960493 | KIT INDICATORI USURA FRENO / SET OF WEAR INDICATORS | BPW | 519 |
| 960774 | KIT INDICATORI USURA FRENO / SET OF WEAR INDICATORS | DAF | 521 |
| 960164 | KIT INDICATORI USURA FRENO / SET OF WEAR INDICATORS | DAF-SCANIA | 522-549 |
| 960751 | KIT INDICATORI USURA FRENO / SET OF WEAR INDICATORS | FORD | 524 |
| 960755 | KIT INDICATORI USURA FRENO / SET OF WEAR INDICATORS | FORD | 524 |
| 960766 | KIT INDICATORI USURA FRENO / SET OF WEAR INDICATORS | FORD | 524 |
| 960771 | KIT INDICATORI USURA FRENO / SET OF WEAR INDICATORS | FORD | 524 |
| 960684 | KIT INDICATORI USURA FRENO / SET OF WEAR INDICATORS | IVECO | 525 |
| 960770 | KIT INDICATORI USURA FRENO / SET OF WEAR INDICATORS | IVECO | 525 |
| 960682 | KIT INDICATORI USURA FRENO / SET OF WEAR INDICATORS | IVECO | 526 |
| 960687 | KIT INDICATORI USURA FRENO / SET OF WEAR INDICATORS | IVECO | 526 |
| 960685 | KIT INDICATORI USURA FRENO / SET OF WEAR INDICATORS | IVECO | 527 |
| 960689 | KIT INDICATORI USURA FRENO / SET OF WEAR INDICATORS | IVECO | 529 |
| 960688 | KIT INDICATORI USURA FRENO / SET OF WEAR INDICATORS | IVECO | 531 |
| 961089 | KIT INDICATORI USURA FRENO / SET OF WEAR INDICATORS | IVECO | 534 |
| 960757 | INDICATORE USURA FRENO / WEAR INDICATOR | MAN-MERCEDES | 536-540 |
| 960753 | KIT INDICATORI USURA FRENO / SET OF WEAR INDICATORS | MAN | 537 |
| 960167 | KIT INDICATORI USURA FRENO / SET OF WEAR INDICATORS | RENAULT | 544 |
| 960767 | KIT INDICATORI USURA FRENO / SET OF WEAR INDICATORS | RENAULT | 544 |
| 960768 | KIT INDICATORI USURA FRENO / SET OF WEAR INDICATORS | RENAULT-VOLVO | 544-552 |
| 960769 | KIT INDICATORI USURA FRENO / SET OF WEAR INDICATORS | RENAULT-VOLVO | 544-552 |
| 960584 | KIT INDICATORI USURA FRENO / SET OF WEAR INDICATORS | SAF | 547 |
| 960585 | KIT INDICATORI USURA FRENO / SET OF WEAR INDICATORS | SAF | 547 |
| 960582 | KIT INDICATORI USURA FRENO / SET OF WEAR INDICATORS | SAF | 548 |



INDICATORI USURA FRENO
WEAR INDICATORS
INDICATEURS D'USURE
VERSCHLEISSANZEIGER
ДАТЧИКИ ИЗНОСА
INDICADOR DE DESGASTE

EMMERRE
spare parts for trucks and trailers

BPW

| Applicazioni / Applications | Dettagli / Detail | Adattabile a / Adaptable to | Emmerre |
|--|--|-----------------------------|---------------|
| 3° Axle SKHBM-SKHSF Eco Maxx SKHSM-SKHSZ Eco Plus SB3745T SB 4309T SB 4345T SH - SKH | - Lunghezza/Length mm. 360 - Connettore tondo/Round Connector - Set 2 pcs. <u>Haldex System</u> <u>Wabco System</u> <u>Knorr System</u> | 0233170800 000824.1 | 960523 |
| Connessione / Connected:  960944E3-960948E3-960994E3-960996E3-960997E3 | | | |
| Connessione / Connected:  960352-960356-960358-960359-960360-960361-960570-960571-960572-960574-960575 | | | |
| Eco Maxx Eco Plus SB3745T SKH SKHBM SKHSF SKHSM SKHSZ | - Lunghezza/Length mm. 340/395 - Connettore tondo/Round Connector - Set 2 pcs. | -- | 960529 |
| Connessione / Connected:  960570-960575  9609994E3 | | | |
| Axle TSB 3709 TSB 4309 TSB 4312 | - Lunghezza/Length mm. 510 - Connettore tondo/Round Connector - Set 2 pcs. - Con supporti/With supports | 01801540490 | 960493 |
| Connessione / Connected:  970024-970025-970026 | | | |
| SH/SHSF SHSM/SHSFA SHZF/SHZM SHZMA | - Lunghezza/Length mm. 360 - Connettore tondo/Round Connector - Set 2 pcs. - Con supporti/With supports | 0580151740 0580151700 | 960492 |













| Emmerre | Adattabile a / <i>Adaptable to</i> | Dettagli / <i>Detail</i> | Applicazioni / <i>Applications</i> |
|---|------------------------------------|--|------------------------------------|
| <p>960523</p>  | <p>0233179800 000824.1</p> | <p>- Lunghezza/Length mm. 360 - Connettore tondo/Round Connector - Set 2 pcs.</p> <p>Haldex System Wabco System Knorr System</p> | <p>Mercedes Axle</p> |
| <p>Connessione / Connected:  960354  960994E3</p> | | | |

INDICATORI USURA FRENO
WEAR INDICATORS
INDICATEURS D'USURE
VERSCHLEISSANZEIGER
ДАТЧИКИ ИЗНОСА
INDICADOR DE DESGASTE



EMMERRE
spare parts for trucks and trailers

DAF

| Applicazioni / Applications | Dettagli / Detail | Adattabile a / Adaptable to | Emmerre |
|--|---|-----------------------------|---------------|
| LF 55 | <ul style="list-style-type: none"> - Anteriore/Front - Lunghezza/Length mm. 380 - Connettore rettangolare/ Rectangular Connector - Con supporti/With supports - Set 2 pcs. <p><u>Wabco System</u></p> | 1628064 | 960774 |
|  | | | |
| Connessione / Connected:  960999E3 | | | |
| LF 45 | <ul style="list-style-type: none"> - Anteriore e posteriore/Front and Rear - Lunghezza/Length mm. 290 - Connettore tondo/Round Connector - Set 2 pcs. <p><u>Wabco System</u></p> | -- | 960801 |
|  | | | |
| Connessione / Connected:  960368-960369-960375  960969E3 | | | |
| LF 55 | <ul style="list-style-type: none"> - Anteriore e posteriore/Front and Rear - Lunghezza/Length mm. 385 - Connettore ovale/Oval Connector - Set 2 pcs. - Senza supporti/Without supports <p><u>Wabco System</u></p> | 68323004 | 960551 |
|  | | | |
| Connessione / Connected:  960376-960377  960272E3 | | | |
| CF 65 | <ul style="list-style-type: none"> - Lunghezza/Length mm. 360 | -- | 960523 |
| CF 75 | <ul style="list-style-type: none"> - Connettore tondo/Round Connector | | |
| CF 85 | <ul style="list-style-type: none"> - Set 2 pcs. | | |
| LF 55 | <u>Haldex System</u> | | |
| XF 95 | <u>Wabco System</u> | | |
| XF 105 | <u>Knorr System</u> | | |
|  | | | |
| Connessione / Connected:  960213  960944E3 | | | |

Indicatori Usura
Wear Indicators

I riferimenti indicati non sono originali ma perfettamente intercambiabili. I codici originali e le case costruttrici sono indicati a puro titolo informativo
The details described are not original but perfectly interchangeable. The original references and manufacturer names are given for information purposes only.

| Emmerre | Adattabile a / <i>Adaptable to</i> | Dettagli / <i>Detail</i> | Applicazioni / <i>Applications</i> |
|---|--|---|---|
| 960164 | 2112768 1902987 1862300 1978632 | - Lunghezza/ <i>Length</i> mm. 310 - Set 2 pcs. <u>Knorr System</u> | CF/LF/XF XF105 CF 65/75/85 LF55 |
|  | | | |
| | | | Connessione / <i>Connected</i> :  960794E3 |

INDICATORI USURA FRENO
WEAR INDICATORS
INDICATEURS D'USURE
VERSCHLEISSANZEIGER
ДАТЧИКИ ИЗНОСА
INDICADOR DE DESGASTE

EMMERRE
spare parts for trucks and trailers
KÄSSBOHRER
BUS

| Applicazioni / Applications | Dettagli / Detail | Adattabile a / Adaptable to | Emmerre |
|-----------------------------|--|-----------------------------|---------------|
| Setra Bus Neoplan | <ul style="list-style-type: none"> - Anteriore/Front - Lunghezza/Length mm. 285/1285 - Connettore Klips/Klips connector - Set 4 pcs. <p>Girling System Knorr System</p> | -- | 960975 |



| | | |
|--------------------------|--|--|
| Connessione / Connected: |  960313 |  960961E3 |
|--------------------------|--|--|

| | | | |
|-----------|--|----------------------------|---------------|
| Setra Bus | <ul style="list-style-type: none"> - Anteriore e posteriore/Front and Rear - Lunghezza/Length mm. 335 - Connettore tondo/Round Connector - Set 2 pcs. <p>Perrot System Wabco System</p> | 81508110004 82823884510 | 960976 |
|-----------|--|----------------------------|---------------|



| | | |
|--------------------------|--|--|
| Connessione / Connected: |  960314 |  960960E3 |
|--------------------------|--|--|









EMMERRE

spare parts for trucks and trailers



FORD













INDICATORI USURA FRENO
WEAR INDICATORS
INDICATEURS D'USURE
VERSCHLEISSANZEIGER
ДАТЧИКИ ИЗНОСА
INDICADOR DE DESGASTE

| Emmerre | Adattabile a / Adaptable to | Dettagli / Detail | Applicazioni / Applications |
|---|-----------------------------|--|-----------------------------|
| 960766   | 1781726 1843310 | - Anteriore/Front - Lunghezza/Length mm. 315 - Set 2 pcs. <u>Bosch System</u> | Transit 2012/2017 |
| 960771   | 1853875 | - Posteriore/Rear - Lunghezza/Length mm. 370 - Set 2 pcs. <u>Bosch System</u> | Transit 2013 |
| 960755   | 1792658 | - Posteriore/Rear - Lunghezza/Length mm. 475 - Set 2 pcs. <u>Bosch System</u> | Transit 2012/2015 |
| 960751   | 1501265/A | - Posteriore/Rear - Lunghezza/Length mm. 570 - Set 2 pcs. <u>Brembo System</u> | -- |

INDICATORI USURA FRENO
WEAR INDICATORS
INDICATEURS D'USURE
VERSCHLEISSANZEIGER
ДАТЧИКИ ИЗНОСА
INDICADOR DE DESGASTE

EMMERRE
spare parts for trucks and trailers

IVECO

| Applicazioni / Applications | Dettagli / Detail | Adattabile a / Adaptable to | Emmerre |
|--|---|---|--|
| Daily 2006/2014 | <ul style="list-style-type: none"> - Anteriore/Front - Lunghezza/Length mm. 215 - Set 2 pcs. <p><u>Brembo System</u></p> | 42567351 5801525030 5801525031 | 960770  |
| Connessione / Connected:  960495  961033 | | | |
| Daily City 2000 New Daily Turbodayly Eurocargo Eurocargo Tector | <ul style="list-style-type: none"> - Anteriore e posteriore/Front and Rear - Lunghezza/Length mm. 295 - Set 2 pcs. <p><u>Bendix System</u> <u>Brembo System</u></p> | 500054528 42548208 1908407 | 960879  |
| Connessione / Connected:  960036-960037-960050-960051-960068-960107-960108-960111-960923 | | | |
| Connessione / Connected:  960899E3-960909E3-960910E3-960912E3-960939E3-960902E3-960973E3-960992E3 | | | |
| Daily City 2000 New Daily Turbodayly Eurocargo Eurocargo Tector | <ul style="list-style-type: none"> - Anteriore e posteriore/Front and Rear - Lunghezza/Length mm. 295 - Set 2 pcs. - Versione Premium/Premium version - Tipo originale con sonda in Vespel/O.E. Type with Vespel Probe <p><u>Bendix System</u> <u>Brembo System</u></p> | 500054528 42548208 1908407 | 960684  |
| Connessione / Connected:  960036-960037-960050-960051-960068-960107-960108-960111-960923 | | | |
| Connessione / Connected:  960899E3-960909E3-960910E3-960912E3-960939E3-960902E3-960973E3-960992E3 | | | |
| Daily 2006 MY Daily City 2000 New Daily Turbodayly | <ul style="list-style-type: none"> - Anteriore e posteriore/Front and Rear - Lunghezza/Length mm. 210 - Set 2 pcs. <p><u>Brembo System</u></p> | 500054693 500054692 42548195 2992393 42560913 42559191 42567352 42567358 | 960864  |
| Connessione / Connected:  960050-960051-960107-960108-960697-960923 | | | |
| Connessione / Connected:  960899E3-960909E3-960910E3-960973E3-960992E3-961015 | | | |













I riferimenti indicati non sono originali ma perfettamente intercambiabili. I codici originali e le case costruttrici sono indicati a puro titolo informativo
The details described are not original but perfectly interchangeable. The original references and manufacturer names are given for information purposes only.

EMMERRE

spare parts for trucks and trailers

IVECO

INDICATORI USURA FRENO
WEAR INDICATORS
INDICATEURS D'USURE
VERSCHLEISSANZEIGER
ДАТЧИКИ ИЗНОСА
INDICADOR DE DESGASTE

| Emmerre | Adattabile a / Adaptable to | Dettagli / Detail | Applicazioni / Applications |
|---|---|--|---|
| 960687  | 500054693 500054692 42548195 2992393 42560913 42559191 42567352 42567358 | <ul style="list-style-type: none">- Anteriore e posteriore/ Front and Rear- Lunghezza/Length mm. 210- Set 2 pcs.- Versione Premium/Premium version- Tipo originale con sonda in Vespel/O.E. Type with Vespel Probe <p><u>Brembo System</u></p> | Daily 2006 MY Daily City 2000 New Daily Turbodaily |
| Connessione / Connected:  960050-960051-960107-960108-960697-960923 | | | |
| Connessione / Connected:  960899E3-960909E3-960910E3-960973E3-960992E3-961015 | | | |
| 960979  | 42548209 2991854 | <ul style="list-style-type: none">- Posteriore/Rear- Lunghezza/Length mm. 295- Connettore ovale/Oval Connector- Set 2 pcs. <p><u>Brembo System</u> <u>Girling System</u></p> | Daily City 2000 |
| Connessione / Connected:  960924  960911E3 | | | |
| 960863  | 500054696 42559616 42548196 2992394 | <ul style="list-style-type: none">- Posteriore/Rear- Lunghezza/Length mm. 250- Connettore ovale/Oval Connector- Set 2 pcs. <p><u>Brembo System</u></p> | Daily City 2000 |
| Connessione / Connected:  960924-960925  960911E3 | | | |
| 960682  | 500054696 42559616 42548196 2992394 | <ul style="list-style-type: none">- Posteriore/Rear- Lunghezza/Length mm. 250- Connettore ovale/Oval Connector- Set 2 pcs.- Versione Premium/Premium version- Tipo originale con sonda in Vespel/O.E. Type with Vespel Probe <p><u>Brembo System</u></p> | Daily City 2000 |
| Connessione / Connected:  960924-960925  960911E3 | | | |



INDICATORI USURA FRENO
WEAR INDICATORS
INDICATEURS D'USURE
VERSCHLEISSANZEIGER
ДАТЧИКИ ИЗНОСА
INDICADOR DE DESGASTE

EMMERRE
spare parts for trucks and trailers

IVECO

| Applicazioni / Applications | Dettagli / Detail | Adattabile a / Adaptable to | Emmerre |
|-----------------------------|---|--|--|
| Daily 2006 MY | <ul style="list-style-type: none"> - Anteriore/Front - Lunghezza/Length mm. 145 - Connettore ovale/Oval Connector - Set 2 pcs. <p><u>Brembo System</u></p> | 42560068 42555634 500054694 42567353 500054697 42567356 | 960514  |













| Connessione / Connected:  960512-960696-960698  960513E3-960895E3 | | | |
|---|---|--|---|
| Daily 2006 MY | <ul style="list-style-type: none"> - Anteriore/Front - Lunghezza/Length mm. 145 - Connettore ovale/Oval Connector - Set 2 pcs. - Versione Premium/Premium version - Tipo originale con sonda in Vespel/O.E. Type with Vespel Probe <p><u>Brembo System</u></p> | 42560068 42555634 500054694 42567353 500054697 42567356 | 960685  |

| Connessione / Connected:  960512-960696-960698  960513E3-960895E3 | | | |
|---|---|-----------------------|---|
| Daily 2006 MY | <ul style="list-style-type: none"> - Posteriore/Rear - Lunghezza/Length mm. 295 - Connettore ovale/Oval Connector - Set 2 pcs. <p><u>Brembo System</u></p> | 500054695 42556205 | 960517  |

| Connessione / Connected:  960498-960515-960694-960695  960516E3 | | | |
|---|---|------------------------|---|
| Daily Serie C 2006-2014 | <ul style="list-style-type: none"> - Posteriore/Rear - Lunghezza/Length mm. 294 - Connettore ovale/Oval Connector - Set 2 pcs. <p><u>Brembo System</u></p> | 42567354 5801486732 | 960780  |

| Connessione / Connected:  960515  960516E3 | |
|--|--|
|--|--|









I riferimenti indicati non sono originali ma perfettamente intercambiabili. I codici originali e le case costruttrici sono indicati a puro titolo informativo
The details described are not original but perfectly interchangeable. The original references and manufacturer names are given for information purposes only.

| Emmerre | Adattabile a / Adaptable to | Dettagli / Detail | Applicazioni / Applications |
|---|-----------------------------|---|---------------------------------------|
| 960779 | 42567355 5801486731 | - Posteriore/Rear - Lunghezza/Length mm. 250 - Connettore ovale/Oval Connector - Set 2 pcs. | Daily serie S 2011-2014 |
|  | | | |
| Connessione / Connected:  960695  960911E3 | | | |
| 960778 | 42567357 42567660 | - Anteriore e posteriore/Front and Rear - Lunghezza/Length mm. 295 - Connettore ovale/Oval Connector - Set 2 pcs. | Daily 1999-2006 Eurocargo |
|  | | | |
| Connessione / Connected:  960050-960036-960037  960992E3-960912E3 | | | |
| 960932 | 1907942 | - Anteriore e posteriore/Front and Rear - Lunghezza/Length mm. 495 - Connettore tondo/Round Connector - Set 2 pcs. Perrot System Wabco System | Eurocargo Eurocargo Tector Zeta |
|  | | | |
| Connessione / Connected:  960032-960036-960037  960912E3-960939E3 | | | |
| 960877 | 1908825 | - Anteriore/Front - Lunghezza/Length mm. 475 - Connettore tondo/Round Connector - Set 2 pcs. Bendix System Brembo System | Eurocargo Eurocargo Tector |
|  | | | |
| Connessione / Connected:  960036-960037  960912E3-960939E3 | | | |

INDICATORI USURA FRENO
WEAR INDICATORS
INDICATEURS D'USURE
VERSCHLEISSANZEIGER
ДАТЧИКИ ИЗНОСА
INDICADOR DE DESGASTE

EMMERRE
spare parts for trucks and trailers

IVECO

| Applicazioni / Applications | Dettagli / Detail | Adattabile a / Adaptable to | Emmerre |
|--|---|-----------------------------|---------------|
| Eurocargo Eurocargo Tector | - Anteriore/Front - Lunghezza/Length mm. 150 - Connettore ovale/Oval Connector - Set 2 pcs. <u>Brembo System</u> | 1906462 | 960888 |
| Connessione / Connected:  960036-960037  960912E3-960939E3 | | | |
| Eurocargo Eurocargo Tector | - Anteriore/Front - Lunghezza/Length mm. 150 - Connettore ovale/Oval Connector - Set 2 pcs. - Versione Premium/Premium version - Tipo originale con sonda in Vespel/O.E. Type with Vespel Probe <u>Brembo System</u> | 1906462 | 960689 |
| Connessione / Connected:  960036-960037  960912E3-960939E3 | | | |
| Eurocargo Eurocargo Tector | - Anteriore/Front - Lunghezza/Length mm. 150 - Connettore ovale/Oval Connector - Set 2 pcs. <u>Perrot System</u> <u>Wabco System</u> | 1908231 503558114 | 960878 |
| Connessione / Connected:  960020-960033-960034-960048-960049-960104-960402  960938E3-960970E3 | | | |
| Eurocargo Eurocargo Tector | - Anteriore/Front - Lunghezza/Length mm. 300 - Connettore tondo/Round Connector - Set 2 pcs. <u>Bendix System</u> <u>Girling System</u> | 1907956 93161191 | 960880 |
| Connessione / Connected:  960020-960033-960034-960048-960049  960938E3-960970E3 | | | |













Indicatori Usura
Wear Indicators

EMMERRE

spare parts for trucks and trailers

IVECO









INDICATORI USURA FRENO
WEAR INDICATORS
INDICATEURS D'USURE
VERSCHLEISSANZEIGER
ДАТЧИКИ ИЗНОСА
INDICADOR DE DESGASTE

| Emmerre | Adattabile a / Adaptable to | Dettagli / Detail | Applicazioni / Applications |
|--|---|---|--|
| 960852  | 42552778 42538068 | - Posteriore/Rear - Lunghezza/Length mm. 630 - Connettore ovale/Oval Connector - Per tamburo freno/For brake drum <u>Meritor System</u> | Eurocargo Eurocargo Tector |
| Connessione / Connected:  963906-963905 | | | |
| 960881  | 1906468 | - Anteriore e posteriore/Front and Rear - Lunghezza/Length mm. 290 - Connettore ovale/Oval Connector - Set 2 pcs. <u>Bendix system</u> <u>Knorr System</u> | Eurocargo Tector |
| Connessione / Connected:  960232  960897 | | | |
| 960805  | 42536956 | - Anteriore e posteriore/Front and Rear - Lunghezza/Length mm. 290 - Connettore ovale/Oval Connector - Set 2 pcs. - Con supporto/With support <u>Wabco System</u> | Eurocargo Tector |
| Connessione / Connected:  960232  960969E3 | | | |
| 960839  | 42537941 2992666 500054985 2992337 | - Anteriore e posteriore/Front and Rear - Lunghezza/Length mm. 300 - Connettore Klips/Klips connector - Set 2 pcs. <u>Knorr SN7 System</u> | Eurocargo Eurotech Eurotech Cursor Eurostar Eurostar Cursor Eurotrækker Cursor Tector Stralis |
| Connessione / Connected:  960944E3-960970E3 | | | |
| Connessione / Connected:  960019-960033-960034-960038-960053-960404-960405-960406-960506-960507 | | | |



INDICATORI USURA FRENO
WEAR INDICATORS
INDICATEURS D'USURE
VERSCHLEISSANZEIGER
ДАТЧИКИ ИЗНОСА
INDICADOR DE DESGASTE

EMMERRE
spare parts for trucks and trailers

IVECO

| Applicazioni / Applications | Dettagli / Detail | Adattabile a / Adaptable to | Emmerre |
|--|---|---|--|
| Eurocargo Eurotech Eurotech Cursor Eurostar Eurostar Cursor Eurotrakker Cursor Tector Stralis | - Anteriore e posteriore/ Front and Rear - Lunghezza/Length mm. 300 - Connettore Klips/Klips connector - Set 2 pcs. - Versione Premium/Premium version - Tipo originale con sonda in Vespel/ O.E. Type with Vespel Probe <u>Knorr SN7 System</u> | 42537941 2992666 500054985 2992337 | 960688  |
| Connessione / Connected:  960944E3-960970E3 | | | |
| Connessione / Connected:  960019-960033-960034-960038-960053-960404-960405-960406-960506-960507 | | | |
| Eurocargo Eurotech Eurotech Cursor Eurostar Eurostar Cursor Eurotrakker Cursor Tector Stralis | - Anteriore e posteriore/ Front and Rear - Lunghezza/Length mm. 1300 / 2 pcs. - Length mm. 270 / 2 pcs. - Connettore Klips/Klips connector - Set 4 pcs. <u>Bendix System</u> <u>Knorr System</u> | 1903651 | 960908  |
| Connessione / Connected:  960937E3-960944E3 | | | |
| Connessione / Connected:  960019-960033-960034-960038-960053-960404-960405-960406 | | | |
| Eurocargo | - Posteriore/Rear - Lunghezza/Length mm. 570 - Connettore ovale/Oval Connector - Per tamburo freno/For brake drum <u>Perrot System</u> <u>Wabco System</u> | 42532204 93192584 | 960886  |
| Connessione / Connected:  963900-963901 | | | |
| Eurocargo Eurotech | - Posteriore/Rear - Lunghezza/Length mm. 955 - Connettore ovale/Oval Connector - Per tamburo freno/For brake drum <u>Rockwell System</u> | 42539438 93193778 | 960887  |









I riferimenti indicati non sono originali ma perfettamente intercambiabili. I codici originali e le case costruttrici sono indicati a puro titolo informativo
The details described are not original but perfectly interchangeable. The original references and manufacturer names are given for information purposes only.



| Emmerre | Adattabile a / Adaptable to | Dettagli / Detail | Applicazioni / Applications |
|--|----------------------------------|---|--|
| 960905  | 42530550 93191114 | - Posteriore/Rear - Lunghezza/Length mm. 1320 - Connettore ovale/Oval Connector - Per tamburo freno/For brake drum Perrot System Wabco System | Eurocargo Eurotech Eurotech Cursor Eurostar Eurotrakker Eurotrakker Cursor |
| 960882  | 42530900 93163524 | - Posteriore/Rear - Lunghezza/Length mm. 565 - Connettore tondo/Round Connector - Per tamburo freno/For brake drum Perrot System Wabco System | Eurocargo Eurotech Eurostar Eurotrakker Cursor |
| 960885  | 42539437 93192921 42552777 | - Posteriore/Rear - Lunghezza/Length mm. 1315 - Connettore ovale/Oval Connector - Per tamburo freno/For brake drum Rockwell System | Eurotech Eurotech Cursor Eurostar Eurotrakker Eurotrakker Cursor |
| 960441  | 42550958 | - Posteriore/Rear - Lunghezza/Length mm. 960 - Connettore ovale/Oval Connector - Per tamburo freno/For brake drum Meritor System | Eurocargo Eurotech Eurostar Eurotrakker Cursor |

INDICATORI USURA FRENO
WEAR INDICATORS
INDICATEURS D'USURE
VERSCHLEISSANZEIGER
ДАТЧИКИ ИЗНОСА
INDICADOR DE DESGASTE

EMMERRE
spare parts for trucks and trailers

IVECO

| Applicazioni / Applications | Dettagli / Detail | Adattabile a / Adaptable to | Emmerre |
|--|--|-----------------------------|---|
| Eurocargo Eurotech Eurostar Eurotrakker Bus | - Boccola per indicatore usura freno/ <i>Bush for brake wear indicator</i> | 42530551 | 960907 |
| | | |  |
| Turbocity City Bus Bus 370 | - Posteriore/Rear - Lunghezza/Length mm. 1480 - Per tamburo freno/For brake drum <u>Rockwell System</u> | 42539439 42532158 | 960508 |
| | | |  |
| Europolis 491 Bus Menarini BMB-M240 | - Anteriore e posteriore/Front and Rear - Lunghezza/Length mm. 200 <u>Meritor System</u> | 2995553 | 960676 |
| | | |  |
| Connessione / Connected:  960222-960224-960414  960901E3 | | | |
| Bus City Elis Arway | - Anteriore e posteriore/Front and Rear - Lunghezza/Length mm. 289 - Connettore ovale/Oval Connector - Set 2 pcs. - Per tamburo freni/For brake drum <u>Meritor System</u> | -- | 960807 |
| | | |  |
| Connessione / Connected:  960212  960798E3 | | | |

| Emmerre | Adattabile a / <i>Adaptable to</i> | Dettagli / <i>Detail</i> | Applicazioni / <i>Applications</i> |
|---|------------------------------------|---|------------------------------------|
| <p>960822</p>  | <p>--</p> | <p>- Anteriore e posteriore/<i>Front and Rear</i> - Lunghezza/<i>Length</i> mm. 194 - Connettore ovale/<i>Oval Connector</i> - Ø mm. 18,70 - Set 2 pcs. - Per tamburo freno/<i>For brake drum</i></p> <p>Meritor System Wabco System</p> | <p>Bus City Elis Arway</p> |
| <p>961089</p>  | <p>69325974</p> | <p>- Anteriore/<i>Front</i> - Lunghezza/<i>Length</i> mm. 390 - Connettore rettangolare/ <i>Rectangular Connector</i> - Set 2 pcs.</p> <p>Meritor System</p> | <p>Iris Bus</p> |
| | | | |

INDICATORI USURA FRENO
WEAR INDICATORS
INDICATEURS D'USURE
VERSCHLEISSANZEIGER
ДАТЧИКИ ИЗНОСА
INDICADOR DE DESGASTE

EMMERRE
spare parts for trucks and trailers

MAN

| Applicazioni / Applications | Dettagli / Detail | Adattabile a / Adaptable to | Emmerre |
|-----------------------------|---|-----------------------------|---------------|
| L 2000 L 2100 | <ul style="list-style-type: none"> - Anteriore e posteriore/ Front and Rear - Lunghezza/Length mm. 295 - Connettore ovale/Oval Connector - Set 2 pcs. - Con supporti/With supports <p><u>Lucas System</u> <u>Meritor System</u> <u>Wabco System</u></p> | 81508226014 81508226013 | 960803 |



| | | |
|--------------------------|-----------------------------|-------------------|
| Connessione / Connected: | 960320-960328-960343-960346 | 960969E3-960955E3 |
|--------------------------|-----------------------------|-------------------|

| | | | |
|------------------|--|----------------------------|---------------|
| L 2000 L 2100 | <ul style="list-style-type: none"> - Anteriore e posteriore/ Front and Rear - Lunghezza/Length mm. 340/395 - Connettore ovale/Oval Connector - Set 2 pcs. - Senza supporti/Without supports <p><u>Knorr System</u></p> | 81508226015 81508226029 | 960553 |
|------------------|--|----------------------------|---------------|



| | | |
|--------------------------|-----------------------------|-------------------|
| Connessione / Connected: | 960320-960328-960343-960346 | 960969E3-960955E3 |
|--------------------------|-----------------------------|-------------------|

| | | | |
|--------|--|--|---------------|
| M 2000 | <ul style="list-style-type: none"> - Anteriore/Front - Lunghezza/Length mm. 338 - Connettore ovale/Oval Connector - Set 2 pcs. <p><u>Lucas System</u> <u>Wabco System</u></p> | 81508226016 81508226011 81508226017 81508226012 68323117 | 960811 |
|--------|--|--|---------------|



| | | |
|--------------------------|--------|----------|
| Connessione / Connected: | 960329 | 960948E3 |
|--------------------------|--------|----------|

| | | | |
|--|---|----------------------------|---------------|
| F 90 F 2000 M 2000 TGA BUS 422 | <ul style="list-style-type: none"> - Anteriore e posteriore/ Front and Rear - Lunghezza/Length mm. 335 - Connettore tondo/Round Connector - Set 2 pcs. <p><u>Perrot System</u> <u>Wabco System</u></p> | 81508110004 82823884510 | 960976 |
|--|---|----------------------------|---------------|



| | | |
|--------------------------|--------|----------|
| Connessione / Connected: | 960322 | 960956E3 |
|--------------------------|--------|----------|

I riferimenti indicati non sono originali ma perfettamente intercambiabili. I codici originali e le case costruttrici sono indicati a puro titolo informativo
The details described are not original but perfectly interchangeable. The original references and manufacturer names are given for information purposes only.

| Emmerre | Adattabile a / Adaptable to | Dettagli / Detail | Applicazioni / Applications |
|---|---|---|---|
| 960822 | 81259376011 | <ul style="list-style-type: none"> - Anteriore e posteriore/ Front and Rear - Lunghezza/Length mm. 194 - Connettore ovale/Oval Connector - Ø mm. 18,70 - Set 2 pcs. - Per tamburo freno/For brake drum <p>Meritor System Wabco System</p> | F 90 F 2000 M 2000 TGA TGX BUS 422 |
|  | 68324072 81508226018 | <ul style="list-style-type: none"> - Anteriore e posteriore/ Front and Rear - Lunghezza/Length mm. 289 - Connettore ovale/Oval Connector - Set 2 pcs. - Per tamburo freno/For brake drum <p>Meritor System</p> | F 2000 M 2000 TGS TGX |
|  | Connessione / Connected:  960100-960321-960393  960956E3-960984E3 | | |
| 960810 | 81259376012 | <ul style="list-style-type: none"> - Anteriore e posteriore/ Front and Rear - Lunghezza/Length mm. 200 - Connettore tondo/Round Connector - Ø mm. 16,80 - Set 2 pcs. - Per tamburo freno/For brake drum <p>Meritor System Wabco System</p> | TGL |
|  | 36508226007 36259376009 | <ul style="list-style-type: none"> - Anteriore e posteriore/ Front and Rear - Lunghezza/Length mm. 355 - Con supporti/With supports | TGA |
|  | | | |

INDICATORI USURA FRENO
WEAR INDICATORS
INDICATEURS D'USURE
VERSCHLEISSANZEIGER
ДАТЧИКИ ИЗНОСА
INDICADOR DE DESGASTE

EMMERRE
spare parts for trucks and trailers

MAN













| Applicazioni / Applications | Dettagli / Detail | Adattabile a / Adaptable to | Emmerre |
|-----------------------------|---|--|---------------|
| TGM | <ul style="list-style-type: none">- Posteriore/Rear- Lunghezza/Length mm. 490- Connettore tondo/Round Connector- Con supporti/With supports- Set 2 pcs. <p><u>Knorr System</u></p> | 81508226035 | 960753 |
| | |  | |
| | | | |
| | | | |
| | | | |

EMMERRE

spare parts for trucks and trailers

MERCEDES



INDICATORI USURA FRENO
WEAR INDICATORS
INDICATEURS D'USURE
VERSCHLEISSANZEIGER
ДАТЧИКИ ИЗНОСА
INDICADOR DE DESGASTE



| Emmerre | Adattabile a / Adaptable to | Dettagli / Detail | Applicazioni / Applications |
|--|-----------------------------|---|-----------------------------|
| 960915  | 9015400017 9015400117 | - Posteriore/Rear - Lunghezza/Length mm. 210 - Connettore ovale/Oval Connector - Set 2 pcs. <u>Bosch System</u> | Vito sprinter |
| | | Connessione / Connected:  960920E3-960921-960922 | |
| | | Connessione / Connected:  960323-960324-960333-960334-960391-960390 | |
| 960825  | 6395401417 6395401517 | - Posteriore/Rear - Lunghezza/Length mm. 95 - Connettore ovale/Oval Connector - Set 2 pcs. <u>Bosch System</u> | Viano Vito Sprinter |
| | | Connessione / Connected:  960422-960450-960565  960451-960776-960890-960896 | |
| 960824  | 9065401417 9065401517 | - Anteriore/Front - Lunghezza/Length mm. 109 - Connettore ovale/Oval Connector - Set 2 pcs. <u>Brembo System</u> | Sprinter |
| | | Connessione / Connected:  960564  960427-960890 | |
| 960435  | 9015400317 | - Anteriore e posteriore/Front and Rear - Lunghezza/Length mm. 189 - Connettore ovale/Oval Connector - Set 2 pcs. <u>Ate System</u> | sprinter |
| | | Connessione / Connected:  960565  960890 | |

INDICATORI USURA FRENO
WEAR INDICATORS
INDICATEURS D'USURE
VERSCHLEISSANZEIGER
ДАТЧИКИ ИЗНОСА
INDICADOR DE DESGASTE

EMMERRE
spare parts for trucks and trailers

MERCEDES

| Applicazioni / Applications | Dettagli / Detail | Adattabile a / Adaptable to | Emmerre |
|--|--|--|---------------|
| Sprinter 508D - 510 512D - L 608D 612D - L 613D 614D - 615D 809D 811D 812D 813D 814D Vario | - Anteriore/Front - Lunghezza/Length mm. 212 - Connettore tondo/Round Connector - Set 2 pcs. <u>Perrot System</u> <u>Wabco System</u> | 6695400417 6695401117 6695400717 | 960916 |
| Connessione / Connected:  960973E3-960946E3-960967E3-960998E3 | | | |
| Connessione / Connected:  960073-960074-960124-960125-960318-960319-960446-960447 | | | |
| 508D 510 L 608D L 613D | - Anteriore/Front - Lunghezza/Length mm. 90 - Connettore tondo/Round Connector - Set 2 pcs. <u>Wabco System</u> | 0005400217 1405401217 6015401317 | 960842 |
| Connessione / Connected:  960335  960967E3 | | | |
| Atego I Atego II | - Posteriore/Rear - Lunghezza/Length mm. 200 - Connettore tondo/Round Connector - Ø mm. 16,80 - Set 2 pcs. - Per tamburo freno/For brake drum <u>Knorr System</u> | 6775400817 | 960810 |
| Atego Atego II Actros 22,5" Axor II MP2/MP3 Travego | - Posteriore/Rear - Lunghezza/Length mm. 200 - Connettore tondo/Round Connector - Ø mm. 19 - Set 2 pcs. - Per tamburo freno/For brake drum <u>Knorr System</u> | 6775400717 | 960808 |

| Emmerre | Adattabile a / Adaptable to | Dettagli / Detail | Applicazioni / Applications |
|---|-----------------------------|--|---|
| 960914 | 3565400017 | - Anteriore e posteriore/ <i>Front and Rear</i> - Lunghezza/ <i>Length</i> mm. 500 - Connettore tondo/ <i>Round Connector</i> - Set 2 pcs. Girling System Lucas System | Evobus Neoplan Menarini Europolis Avancity 0303 0305 0404 Turismo |
| Connessione / Connected:  960315-960693  960956E3 | | | |
| 960975 | -- | - Anteriore e posteriore/ <i>Front and Rear</i> - Lunghezza/ <i>Length</i> mm. 285/1285 - Connettore Klips/ <i>Klips connector</i> - Set 4 pcs. Girling System Knorr System | Actros |
| 960757 | 0035426818 | - Anteriore e posteriore/ <i>Front and Rear</i> - Lunghezza/ <i>Length</i> mm. 355 - Con supporti/ <i>With supports</i> | Trucks |



INDICATORI USURA FRENO
WEAR INDICATORS
INDICATEURS D'USURE
VERSCHLEISSANZEIGER
ДАТЧИКИ ИЗНОСА
INDICADOR DE DESGASTE

EMMERRE
spare parts for trucks and trailers

NISSAN













| Applicazioni / Applications | Dettagli / Detail | Adattabile a / Adaptable to | Emmerre |
|--|--|-----------------------------|---------------|
| Atleon 120 | <ul style="list-style-type: none"> - Anteriore e posteriore / <i>Front and Rear</i> - Lunghezza / <i>Length</i> mm. 260 - Tag connector - Set 2 pcs. <p><u>Brembo System</u></p> | 44069-9X400 | 960819 |
|  | | | |
| <p>Connessione / Connected:  960057-960058  960875E3</p> | | | |

EMMERRE

spare parts for trucks and trailers

RENAULT









INDICATORI USURA FRENO
WEAR INDICATORS
INDICATEURS D'USURE
VERSCHLEISSANZEIGER
ДАТЧИКИ ИЗНОСА
INDICADOR DE DESGASTE

| Emmerre | Adattabile a / Adaptable to | Dettagli / Detail | Applicazioni / Applications |
|--|--|--|--------------------------------|
| 960819  | 5001850859/A 5001844747/A | - Anteriore e posteriore/ Front and Rear - Lunghezza/Length mm. 260 - Tag connector - Set 2 pcs. <u>Brembo System</u> | Mascott |
| Connessione / Connected:  960209-960229-960230-960392  960972E3-960987E3 | | | |
| 960919  | 5001822897 68320654 | - Anteriore/ Front - Lunghezza/Length mm. 580 - Tag connector - Set 2 pcs. <u>Girling System</u> | Midliner 1993 Messenger Bus |
| Connessione / Connected:  960305-960342  960959E3 | | | |
| 960918  | 68320909 68320874 | - Anteriore/ Front - Lunghezza/Length mm. 885 - Connettore ovale/ Oval Connector - Set 2 pcs. <u>Girling System</u> | Midliner |
| Connessione / Connected:  960939E3-960957 | | | |
| Connessione / Connected:  960199 -960227-960228 -960308-960237-960242-960239-960238 | | | |
| 960977  | 68321484 68321348 5001831161/A 5001846034/A | - Anteriore/ Front - Lunghezza/Length mm. 270 - Connettore quadrato/ Square connector - Set 2 pcs. <u>Lucas System</u> <u>Meritor System</u> | Midliner Midlum |
| Connessione / Connected:  960228  960991 | | | |









INDICATORI USURA FRENO
WEAR INDICATORS
INDICATEURS D'USURE
VERSCHLEISSANZEIGER
ДАТЧИКИ ИЗНОСА
INDICADOR DE DESGASTE

EMMERRE
spare parts for trucks and trailers

RENAULT

| Applicazioni / Applications | Dettagli / Detail | Adattabile a / Adaptable to | Emmerre |
|--|--|-----------------------------|---------------|
| Midlum | <ul style="list-style-type: none"> - Anteriore e posteriore/ Front and Rear - Lunghezza/Length mm. 300 - Connettore quadrato/Square connector - Set 2 pcs. - Con supporti/With supports <p><u>Wabco System</u></p> | 5010848607/A | 960806 |
| <p>Connessione / Connected:  960969E3-960270-960272E3</p> <p>Connessione / Connected:  960237-960238-960239-960240-960242-960475</p> | | | |
| Midlum | <ul style="list-style-type: none"> - Anteriore e posteriore/ Front and Rear - Lunghezza/Length mm. 399 - Connettore quadrato/Square connector - Set 2 pcs. - Senza supporti/Without supports | -- | 960440 |
| <p>Connessione / Connected:  960969E3-960270-960272E3</p> <p>Connessione / Connected:  960237-960238-960239-960240-960242-960475</p> | | | |
| R 340 R 350 R 385 R 420 | <ul style="list-style-type: none"> - Anteriore/Front - Lunghezza/Length mm. 415 - Tag connector - Set 2 pcs. <p><u>Girling System</u></p> | 5000297198/A | 960917 |
| <p>Connessione / Connected:  960306  960958</p> | | | |
| Magnum Premium Distribution Premium Route | <ul style="list-style-type: none"> - Anteriore/Front - Lunghezza/Length mm. 365 - Connettore ovale/Oval Connector - Set 2 pcs. <p><u>Meritor System</u></p> | 5001822987/A | 960814 |
| <p>Connessione / Connected:  960226-960307-960500  960956E3-960983E3</p> | | | |





| Emmerre | Adattabile a / Adaptable to | Dettagli / Detail | Applicazioni / Applications |
|---|-----------------------------|---|-----------------------------|
| 960167  | 5001855902/A | - Anteriore e posteriore/ Front and Rear - Lunghezza/Length mm. 450 - Con supporti/With supports - Set 2 pcs. Meritor System | Midlum |
| Connessione / Connected:  960273E3 | | | |
| 960769  | 5001866914/A | - Anteriore e posteriore/ Front and Rear - Lunghezza/Length mm. 315-375 - Connettore quadrato/Square connector - Senza supporti/Without supports - Set 2 pcs. Haldex System | Midlum |
| Connessione / Connected:  960823 | | | |
| 960767  | 7485137789/A | - Anteriore e posteriore/ Front and Rear - Lunghezza/Length mm. 360 - Connettore quadrato/Square connector - Con supporti/With supports - Set 2 pcs. Wabco System | Midlum |
| Connessione / Connected:  960272E3 | | | |
| 960768  | 7485110419 | - Anteriore e posteriore/ Front and Rear - Lunghezza/Length mm. 355 - Connettore quadrato/Square connector - Con supporti/With supports - Set 2 pcs. | Magnum Premium |
| Connessione / Connected:  960394E3-960270-970006E3 | | | |

INDICATORI USURA FRENO
WEAR INDICATORS
INDICATEURS D'USURE
VERSCHLEISSANZEIGER
ДАТЧИКИ ИЗНОСА
INDICADOR DE DESGASTE

EMMERRE
spare parts for trucks and trailers

RENAULT

| Applicazioni / Applications | Dettagli / Detail | Adattabile a / Adaptable to | Emmerre |
|---|---|-----------------------------|---------------|
| Magnum Premium Distribution Premium Route | - Anteriore/Front - Lunghezza/Length mm. 355 - Connettore quadrato/Square connector - Set 2 pcs. <u>Meritor System</u> | 5001834075/A | 960933 |
|  | | | |
| Connessione / Connected:  960307  960956E3 | | | |
| Magnum Premium Distribution Premium Route | - Anteriore/Front - Lunghezza/Length mm. 270 - Connettore quadrato/Square connector - Set 2 pcs. <u>Girling System</u> <u>Lucas System</u> <u>Meritor System</u> | 68321348 5001831161 | 960977 |
|  | | | |
| Connessione / Connected:  960307  960982E3 | | | |
| Magnum Premium Distribution Premium Route Premium Distribution II Premium Route II | - Anteriore e posteriore/Front and Rear - Lunghezza/Length mm. 350 - Connettore quadrato/Square connector - Set 2 pcs. <u>Meritor System</u> | 68325408 | 960434 |
|  | | | |
| Connessione / Connected:  960225-960226-960500  960983E3-960989E3 | | | |
| Magnum DXI 12 Magnum DXI 13 Premium Distribution II Premium Route II | - Posteriore/Rear - Lunghezza/Length mm. 360 - Set 2 pcs. <u>Meritor System</u> | 5001855646/A | 960804 |
|  | | | |
| Connessione / Connected:  960225-960226-960464-960500  960983E3 | | | |

| Emmerre | Adattabile a / Adaptable to | Dettagli / Detail | Applicazioni / Applications |
|---|-----------------------------|--|--|
| 960525 | -- | <ul style="list-style-type: none"> - Lunghezza/Length mm. 380 - Connettore ovale/Oval Connector - Set 2 pcs. <p style="text-align: right;">Meritor System</p> | <ul style="list-style-type: none"> LC LM TM |
| Connessione / Connected:  960110-960417-960301-960350-960351  960394E3-960928E3 | | | |
| 960530 | -- | <ul style="list-style-type: none"> - Lunghezza/Length mm. 445 - Connettore quadrato/Square connector - Set 2 pcs. <p style="text-align: right;">Lucas System Meritor System</p> | <ul style="list-style-type: none"> LC LM TM |
| 960531 | -- | <ul style="list-style-type: none"> - Lunghezza/Length mm. 660 - Connettore quadrato/Square connector - Set 2 pcs. <p style="text-align: right;">Meritor system</p> | <ul style="list-style-type: none"> Elsa 2 LC LM TA TC |
| 960532 | -- | <ul style="list-style-type: none"> - Lunghezza/Length mm. 660 - Connettore tondo/Round Connector - Set 2 pcs. <p style="text-align: right;">Meritor system</p> | <ul style="list-style-type: none"> D Duco TA TC |



INDICATORI USURA FRENO
WEAR INDICATORS
INDICATEURS D'USURE
VERSCHLEISSANZEIGER
ДАТЧИКИ ИЗНОСА
INDICADOR DE DESGASTE

EMMERRE
spare parts for trucks and trailers

SAF

| Applicazioni / Applications | Dettagli / Detail | Adattabile a / Adaptable to | Emmerre |
|-----------------------------|--|-----------------------------|---------------|
| SBS2220 Axle | <ul style="list-style-type: none"> - Lunghezza/Length mm. 760 - Connettore tondo/Round Connector - Set 2 pcs. - Con supporti/With supports <p><u>Haldex System</u></p> | 3424203300 | 960584 |





| Connessione / Connected:  960396  960773 | | | |
|--|---|------------|---------------|
| Axle | <ul style="list-style-type: none"> - Lunghezza/Length mm. 760 - Connettore tondo/Round Connector - Set 2 pcs. - Con supporti/With supports <p><u>Knorr System</u></p> | 3424200400 | 960585 |



| | | | |
|--------------------------------------|--|----------|---------------|
| Trailer SK TE4 Axles TE5 Axles | <ul style="list-style-type: none"> - Lunghezza/Length mm. 360 - Connettore tondo/Round Connector - Set 2 pcs. <p><u>Haldex System</u> <u>Knorr System</u> <u>Wabco System</u></p> | 000824.1 | 960523 |
|--------------------------------------|--|----------|---------------|



| Connessione / Connected:  960298-960353-960362  960944E3-960948E3-960949E3-960999E3 | | | |
|---|--|------------|---------------|
| SK1000 SK9022 SK11222 | <ul style="list-style-type: none"> - Lunghezza/Length mm. 930 - Connettore tondo/Round Connector - Set 2 pcs. <p><u>Haldex system</u></p> | 3424200600 | 960524 |



| Connessione / Connected:  960353-960362  960944E3-960949E3 | | | |
|--|--|--|--|
|--|--|--|--|







I riferimenti indicati non sono originali ma perfettamente intercambiabili. I codici originali e le case costruttrici sono indicati a puro titolo informativo
The details described are not original but perfectly interchangeable. The original references and manufacturer names are given for information purposes only.

| Emmerre | Adattabile a / <i>Adaptable to</i> | Dettagli / <i>Detail</i> | Applicazioni / <i>Applications</i> |
|--|------------------------------------|---|--|
| <p>960582</p>  | <p>3424200100</p> | <ul style="list-style-type: none"> - Lunghezza/Length mm. 760 - Connettore tondo/Round Connector - Con supporti/With supports - Set 2 pcs. <p><u>Wabco System</u></p> | <p>Axle SKRB/SKRLB SKRS/SKRZ</p> |
| | | | |
| | | | |
| | | | |



INDICATORI USURA FRENO
WEAR INDICATORS
INDICATEURS D'USURE
VERSCHLEISSANZEIGER
ДАТЧИКИ ИЗНОСА
INDICADOR DE DESGASTE

EMMERRE
spare parts for trucks and trailers

SCANIA

| Applicazioni / Applications | Dettagli / Detail | Adattabile a / Adaptable to | Emmerre |
|--|--|-----------------------------|---------------|
| 94 114 124 144 164 | <ul style="list-style-type: none"> - Anteriore e posteriore/<i>Front and Rear</i> - Lunghezza/<i>Length</i> mm. 285/1285 - Connettore Klips/<i>Klips connector</i> - Set 4 pcs. <p>Girling System Knorr System</p> | -- | 960975 |
| Connessione / Connected:  960052  960944E3 | | | |
| 94 114 124 144 164 | <ul style="list-style-type: none"> - Anteriore e posteriore/<i>Front and Rear</i> - Lunghezza/<i>Length</i> mm. 285 - Connettore Klips/<i>Klips connector</i> - Set 2 pcs. <p>Girling System Knorr System</p> | 1388953 | 960838 |
| Connessione / Connected:  960052  960944E3 | | | |
| 94 114 124 144 164 | <ul style="list-style-type: none"> - Lunghezza/<i>Length</i> mm. 360 - Connettore tondo/<i>Round Connector</i> - Set 2 pcs. <p>Haldex System Knorr System Wabco System</p> | -- | 960523 |
| Connessione / Connected:  960052  960944E3 | | | |
| Serie PG RT Serie 4 | <ul style="list-style-type: none"> - Anteriore e posteriore/<i>Front and Rear</i> - Lunghezza/<i>Length</i> mm. 310 - Connettore Klips/<i>Klips connector</i> <p>Knorr System</p> | 1414156 1388953 | 960164 |











| Emmerre | Adattabile a / <i>Adaptable to</i> | Dettagli / <i>Detail</i> | Applicazioni / <i>Applications</i> |
|--|------------------------------------|--|------------------------------------|
| <p>960523</p>  | <p>--</p> | <p>- Lunghezza/<i>Length</i> mm. 360 - Connettore tondo/<i>Round Connector</i> - Set 2 pcs.</p> <p>Haldex System Knorr System Wabco System</p> | <p>Trailer 9 Ton</p> |
| <p>Connessione / <i>Connected:</i>  960363-960364  960944E3-960948E3</p> | | | |

INDICATORI USURA FRENO
WEAR INDICATORS
INDICATEURS D'USURE
VERSCHLEISSANZEIGER
ДАТЧИКИ ИЗНОСА
INDICADOR DE DESGASTE

EMMERRE
spare parts for trucks and trailers

VOLVO

| Applicazioni / Applications | Dettagli / Detail | Adattabile a / Adaptable to | Emmerre |
|---|--|-----------------------------|---------|
| FL 6 | <ul style="list-style-type: none"> - Lunghezza/Length mm. 380 - Connettore ovale/Oval Connector - Set 2 pcs. <p>Meritor System</p> | -- | 960525 |
|  | | | |
| Connessione / Connected:  960407  960271-960394E3 | | | |
| FH12 FH16 | <ul style="list-style-type: none"> - Anteriore e posteriore/Front and Rear - Lunghezza/Length mm. 350 - Connettore quadrato/Square connector - Set 2 pcs. <p>Meritor System</p> | 68325408 | 960434 |
|  | | | |
| Connessione / Connected:  960394E3 | | | |
| FL 180 FL 220 FL 250 | <ul style="list-style-type: none"> - Lunghezza/Length mm. 360 - Connettore tondo/Round Connector - Set 2 pcs. <p> Haldex System Knorr System Wabco System </p> | -- | 960523 |
|  | | | |
| Connessione / Connected:  960347 | | | |
| B 10L B 12 | <ul style="list-style-type: none"> - Anteriore/Front - Lunghezza/Length mm. 270 - Connettore quadrato/Square connector - Set 2 pcs. <p> Girling System Lucas System Meritor System </p> | 3118128 | 960977 |
|  | | | |
| Connessione / Connected:  960964E3 | | | |









I riferimenti indicati non sono originali ma perfettamente intercambiabili. I codici originali e le case costruttrici sono indicati a puro titolo informativo
The details described are not original but perfectly interchangeable. The original references and manufacturer names are given for information purposes only.

EMMERRE

spare parts for trucks and trailers

VOLVO

INDICATORI USURA FRENO
WEAR INDICATORS
INDICATEURS D'USURE
VERSCHLEISSANZEIGER
ДАТЧИКИ ИЗНОСА
INDICADOR DE DESGASTE

| Emmerre | Adattabile a / Adaptable to | Dettagli / Detail | Applicazioni / Applications |
|--|---|--|---|
| 960781  | 20928533 20392985 20442608 3986607 | - Anteriore e posteriore/ Front and Rear - Lunghezza/Length mm. 1672 - Connettore tondo/Round Connector - Set 1 pcs. | F10/12 FH12/16 FH16 II FL 10/12/6 FM 7/12/9 N10/NH12 |
| | | | Connessione / Connected:  960993E3 |
| 960783  | 20928532 20442607 20392986 | - Anteriore e posteriore/ Front and Rear - Lunghezza/Length mm. 950 - Connettore tondo/Round Connector - Set 1 pcs. | FH12/16 FM 9/12 |
| | | | Connessione / Connected:  960993E3 |
| 960769  | 20844903/A | - Anteriore e posteriore/ Front and Rear - Lunghezza/Length mm. 315/375 - Connettore quadrato/Square connector - Set 2 pcs. - Senza supporti/Without supports | FL II |
| | | | Connessione / Connected:  960823 |
| 960768  | 85110419 | - Anteriore e posteriore/ Front and Rear - Lunghezza/Length mm. 355 - Connettore quadrato/Square connector - Set 2 pcs. - Con supporti/With supports | FL FH 16/12 FM |
| | | | Connessione / Connected:  960394E3-960270-970006E3 |



PINZE FRENO

BRAKE CALIPERS
ETRIERS DE FREIN
BREMSSATTEL
СУППОРТА И РЕМОНТНЫЕ КОМПЛЕКТЫ
PINZAS DE FRENO

BRAKE PARTS MANUFACTURER
TECHNO
BRAKE СЪЗДАТЕЛИ

NEWS











| Emmerre | Descrizione/Description | Adattabile/Adaptable to | Pagina/Page |
|---------------|---|----------------------------|--------------------|
| 975236 | PINZA FRENO POSTERIORE DESTRA / REAR AND RIGHT BRAKE CALIPER | FIAT | 553 |
| 975237 | PINZA FRENO POSTERIORE SINISTRA / REAR AND LEFT BRAKE CALIPER | FIAT | 553 |
| 975238 | PINZA FRENO ANTERIORE DESTRA / FRONT AND RIGHT BRAKE CALIPER | FIAT | 553 |
| 975239 | PINZA FRENO ANTERIORE SINISTRA / FRONT AND LEFT BRAKE CALIPER | FIAT | 553 |
| 975215 | PINZA FRENO DESTRA / RIGHT BRAKE CALIPER | ISUZU | 556 |
| 975216 | PINZA FRENO SINISTRA / LEFT BRAKE CALIPER | ISUZU | 556 |
| 975200 | PINZA FRENO ANTERIORE DESTRA / FRONT AND RIGHT BRAKE CALIPER | IVECO | 564 |
| 975201 | PINZA FRENO ANTERIORE SINISTRA / FRONT AND LEFT BRAKE CALIPER | IVECO | 564 |
| 975190 | PINZA FRENO ANTERIORE DESTRA / FRONT AND RIGHT BRAKE CALIPER | MERCEDES | 569 |
| 975191 | PINZA FRENO ANTERIORE SINISTRA / FRONT AND LEFT BRAKE CALIPER | MERCEDES | 569 |
| 975192 | PINZA FRENO ANTERIORE SINISTRA / FRONT AND LEFT BRAKE CALIPER | MERCEDES | 569 |
| 975193 | PINZA FRENO ANTERIORE DESTRA / FRONT AND RIGHT BRAKE CALIPER | MERCEDES | 569 |
| 960745 | KIT REVISIONE PINZE FRENO / BRAKE CALIPERS REPAIRING KIT | IVECO | 584 |
| 970752 | KIT REVISIONE PINZE FRENO / BRAKE CALIPERS REPAIRING KIT | IVECO | 606 |
| 960678 | KIT REVISIONE PINZE FRENO / BRAKE CALIPERS REPAIRING KIT | NISSAN-OPEL-RENAULT | 609-610-611 |
| 960679 | KIT REVISIONE PINZE FRENO / BRAKE CALIPERS REPAIRING KIT | NISSAN-OPEL-RENAULT | 609-610-611 |
| 960680 | PISTONE PINZE FRENO / BRAKE CALIPER PISTON | NISSAN-OPEL-RENAULT | 609-610-612 |
| 960752 | KIT REVISIONE PINZE FRENO / BRAKE CALIPERS REPAIRING KIT | RENAULT-VOLVO | 611-621 |

**PINZE FRENO
BRAKE CALIPERS
ETRIERS DE FREIN
BREMSSATTEL
СУППОРТА И РЕМОНТНЫЕ КОМПЛЕКТЫ
PINZAS DE FRENO**

EMMERRE
spare parts for trucks and trailers

FIAT





| Applicazioni / Applications | Dettagli / Detail | Adattabile a / Adaptable to | Emmerre |
|---|---|--|--|
| Ducato Citroen Jumper Peugeot Boxer | - Posteriore/Rear - Destra/Right - Senza pastiglie/Without brake pads - Cilindro/Cylinder Ø 48 mm | 77366668 77364133 4401K5 | 975236  |
| Ducato Citroen Jumper Peugeot Boxer | - Posteriore/Rear - Sinistra/Left - Senza pastiglie/Without brake pads - Cilindro/Cylinder Ø 48 mm | 77366667 77364132 4401K4 | 975237  |
| Ducato Citroen Jumper Peugeot Boxer | - Anteriore/Front - Destra/Right - Senza pastiglie/Without brake pads - Cilindro/Cylinder Ø 44/48 mm | 77364043 71793159 71793160 4401J7 | 975238  |
| Ducato Citroen Jumper Peugeot Boxer | - Anteriore/Front - Sinistra/Left - Senza pastiglie/Without brake pads - Cilindro/Cylinder Ø 44/48 mm | 77364042 71793157 71793156 4401J6 | 975239  |



| Emmerre | Adattabile a / Adaptable to | Dettagli / Detail | Applicazioni / Applications |
|--|--|--|---|
| 975230  | 77364457 77362182 77362703 4401E7 | - Anteriore/ <i>Front</i> - Destra/ <i>Right</i> - Senza pastiglie/ <i>Without brake pads</i> | Ducato Citroen Jumper Peugeot Boxer |
| | | Connessione / Connected:  960171  960380 | |
| 975231  | 77364456 77362702 9949415 4401E6 | - Anteriore/ <i>Front</i> - Sinistra/ <i>Left</i> - Senza pastiglie/ <i>Without brake pads</i> | Ducato Citroen Jumper Peugeot Boxer |
| | | Connessione / Connected:  960171  960380 | |
| 975234  | 735353871 | - Posteriore/ <i>Rear</i> - Destra/ <i>Right</i> - Senza pastiglie/ <i>Without brake pads</i> | Ducato |
| | | Connessione / Connected:  960173 | |
| 975235  | 735353870 | - Posteriore/ <i>Rear</i> - Sinistra/ <i>Left</i> - Senza pastiglie/ <i>Without brake pads</i> | Ducato |
| | | Connessione / Connected:  960173 | |

**PINZE FRENO
BRAKE CALIPERS
ETRIERS DE FREIN
BREMSSATTEL
СУППОРТА И РЕМОНТНЫЕ КОМПЛЕКТЫ
PINZAS DE FRENO**

EMMERRE
spare parts for trucks and trailers

FORD











| Applicazioni / Applications | Dettagli / Detail | Adattabile a / Adaptable to | Emmerre |
|-----------------------------|---|-----------------------------|---|
| Transit | - Anteriore/Front - Sinistra/Left - Senza pastiglie/Without brake pads | 4055820 | 975348 |
| | | |  |
| Transit | - Anteriore/Front - Destra/Right - Senza pastiglie/Without brake pads | 4055819 | 975349 |
| | | |  |
| Transit | - Posteriore/Rear - Sinistra/Left - Senza pastiglie/Without brake pads | 1521636 1433964 | 975347 |
| | | |  |
| Transit | - Posteriore/Rear - Destra/Right - Senza pastiglie Without brake pads | 1521632 1433963 | 975346 |
| | | |  |

| Emmerre | Adattabile a / <i>Adaptable to</i> | Dettagli / <i>Detail</i> | Applicazioni / <i>Applications</i> |
|---|------------------------------------|--|------------------------------------|
| <p>975215</p>  | <p>8983034710</p> | <p>- Destra/<i>Right</i> - Senza pastiglie/<i>Without brake pads</i></p> | <p>NRL 85</p> |
| <p>975216</p>  | <p>8983034720</p> | <p>- Sinistra/<i>Left</i> - Senza pastiglie/<i>Without brake pads</i></p> | <p>NRL 85</p> |
| | | | |

**PINZE FRENO
BRAKE CALIPERS
ETRIERS DE FREIN
BREMSSATTEL
СУППОРТА И РЕМОНТНЫЕ КОМПЛЕКТЫ
PINZAS DE FRENO**

EMMERRE
spare parts for trucks and trailers

IVECO

| Applicazioni / Applications | Dettagli / Detail | Adattabile a / Adaptable to | Emmerre |
|--|--|----------------------------------|---------------|
| Daily 1996 | - Anteriore/Front - Destra/Right - Senza pastiglie/Without brake pads | 42561696 42532363 99464095 | 960373 |
| Connessione / Connected:  960894E3 - 960995  960830 - 960850 - 960846 - 960889  960022 - 960021 | | | |
| Daily 1996 | - Anteriore/Front - Sinistra/Left - Senza pastiglie/Without brake pads | 42561695 42532362 99464094 | 960372 |
| Connessione / Connected:  960894E3 - 960995  960830 - 960850 - 960846 - 960889  960022 - 960021 | | | |
| Daily 45/49.10 35/45/49/59.12 | - Anteriore/Front - Destra/Right - Senza pastiglie/Without brake pads | 42561704 99464101 98410369 | 965056 |
| Connessione / Connected:  960941E3 - 960900E3  960832 - 960848 - 965059 - 965058 | | | |
| Daily 45/49.10 35/45/49/59.12 | - Anteriore/Front - Sinistra/Left - Senza pastiglie/Without brake pads | 42561703 99464100 98410367 | 965057 |
| Connessione / Connected:  960941E3 - 960900E3  960832 - 960848 - 965059 - 965058 | | | |

















I riferimenti indicati non sono originali ma perfettamente intercambiabili. I codici originali e le case costruttrici sono indicati a puro titolo informativo
The details described are not original but perfectly interchangeable. The original references and manufacturer names are given for information purposes only.

EMMERRE

spare parts for trucks and trailers

IVECO











PINZE FRENO BRAKE CALIPERS ETRIERS DE FREIN BREMSSATTEL СУППОРТА И РЕМОНТНЫЕ КОМПЛЕКТЫ PINZAS DE FRENO

| Emmerre | Adattabile a / Adaptable to | Dettagli / Detail | Applicazioni / Applications |
|---|----------------------------------|--|------------------------------|
| 975081  | 42548188 42536625 42536173 | - Anteriore/Front - Destra/Right - Senza pastiglie/Without brake pads | Daily '96 Daily City 2000 |
| Connessione / Connected:  960909E3 - 960992E3  960834 - 960700 - 960828 - 960703  960050 | | | |
| 975080  | 42548187 42536624 42536172 | - Anteriore/Front - Sinistra/Left - Senza pastiglie/Without brake pads | Daily '96 Daily City 2000 |
| Connessione / Connected:  960909E3 - 960992E3  960834 - 960700 - 960828 - 960703  960050 | | | |
| 975083  | 42548190 42536627 42536175 | - Posteriore/Rear - Destra/Right - Senza pastiglie/Without brake pads | Daily '96 Daily City 2000 |
| Connessione / Connected:  960909E3 - 960992E3  960834 - 960700 - 960828 - 960703  960051 | | | |
| 975082  | 42548189 42536626 42536174 | - Posteriore/Rear - Sinistra/Left - Senza pastiglie/Without brake pads | Daily '96 Daily City 2000 |
| Connessione / Connected:  960909E3 - 960992E3  960834 - 960700 - 960828 - 960703  960051 | | | |

**PINZE FRENO
BRAKE CALIPERS
ETRIERS DE FREIN
BREMSSATTEL
СУППОРТА И РЕМОНТНЫЕ КОМПЛЕКТЫ
PINZAS DE FRENO**

EMMERRE
spare parts for trucks and trailers

IVECO

| Applicazioni / Applications | Dettagli / Detail | Adattabile a / Adaptable to | Emmerre |
|---|--|----------------------------------|---------------|
| Daily Turbodaily '96 | - Anteriore/Front - Destra/Right - Senza pastiglie/Without brake pads | 99465473 99465632 98438402 | 975085 |
| Connessione / Connected:  960940 - 960974  960017 - 960026  960039 | | | |
| Daily Turbodaily '96 | - Anteriore/Front - Sinistra/Left - Senza pastiglie/Without brake pads | 99465472 99465631 98438401 | 975084 |
| Connessione / Connected:  960940 - 960974  960017 - 960026  960039 | | | |
| Daily M.Y. 2006 | - Posteriore/Rear - Destra/Right - Senza pastiglie/Without brake pads | 42554991 504122834 | 975091 |
| Connessione / Connected:  960895E3  960013 - 960014 - 960015 - 960016 - 960719  960698 | | | |
| Daily M.Y. 2006 | - Posteriore/Rear - Sinistra/Left - Senza pastiglie/Without brake pads | 42554990 504122833 | 975090 |
| Connessione / Connected:  960895E3  960013 - 960014 - 960015 - 960016 - 960719  960698 | | | |















I riferimenti indicati non sono originali ma perfettamente intercambiabili. I codici originali e le case costruttrici sono indicati a puro titolo informativo
The details described are not original but perfectly interchangeable. The original references and manufacturer names are given for information purposes only.

EMMERRE

spare parts for trucks and trailers

IVECO

PINZE FRENO BRAKE CALIPERS ETRIERS DE FREIN BREMSSATTEL СУППОРТА И РЕМОНТНЫЕ КОМПЛЕКТЫ PINZAS DE FRENO

| Emmerre | Adattabile a / Adaptable to | Dettagli / Detail | Applicazioni / Applications |
|--|------------------------------------|--|-----------------------------|
| 975120  | 42536629 504090406 504028770 | - Anteriore/Front - Destra/Right - Senza pastiglie/Without brake pads | Daily City 2000 |
| Connessione / Connected:  960910E3  960834 - 960700 - 960828 - 960703  960923 | | | |
| 975119  | 42536628 504090405 504028767 | - Anteriore/Front - Sinistra/Left - Senza pastiglie/Without brake pads | Daily City 2000 |
| Connessione / Connected:  960910E3  960834 - 960700 - 960828 - 960703  960923 | | | |
| 975093  | 42559618 42554778 | - Posteriore/Rear - Destra/Right - Senza pastiglie/Without brake pads | Daily City 2000 |
| Connessione / Connected:  960911E3  960748 - 960746 | | | |
| 975092  | 42559617 42554777 | - Posteriore/Rear - Sinistra/Left - Senza pastiglie/Without brake pads | Daily City 2000 |
| Connessione / Connected:  960911E3  960749 - 960746 | | | |



**PINZE FRENO
BRAKE CALIPERS
ETRIERS DE FREIN
BREMSSATTEL
СУППОРТА И РЕМОНТНЫЕ КОМПЛЕКТЫ
PINZAS DE FRENO**

EMMERRE
spare parts for trucks and trailers

IVECO



| Applicazioni / Applications | Dettagli / Detail | Adattabile a / Adaptable to | Emmerre |
|-----------------------------|---|----------------------------------|---------------|
| Daily M.Y. 2006 | - Anteriore/Front - Destra/Right - Senza pastiglie/Without brake pads | 42548184 42536633 42535600 | 975105 |



| Connessione / Connected:  960973E3  960703 - 960714 - 960739 - 960835 | | | |
|---|--|--|--|
|---|--|--|--|



| | | | |
|-----------------|--|----------------------------------|---------------|
| Daily M.Y. 2006 | - Anteriore/Front - Sinistra/Left - Senza pastiglie/Without brake pads | 42548183 42536632 42535599 | 975104 |
|-----------------|--|----------------------------------|---------------|



| Connessione / Connected:  960973E3  960703 - 960714 - 960739 - 960835 | | | |
|---|--|--|--|
|---|--|--|--|

| | | | |
|-----------------|---|----------------------------------|---------------|
| Daily M.Y. 2006 | - Posteriore/Rear - Destra/Right - Senza pastiglie/Without brake pads | 42548186 42536635 42535439 | 975107 |
|-----------------|---|----------------------------------|---------------|



| Connessione / Connected:  960973E3  960836 - 960715 - 960703 | | | |
|--|--|--|--|
|--|--|--|--|

| | | | |
|-----------------|--|----------------------------------|---------------|
| Daily M.Y. 2006 | - Posteriore/Rear - Sinistra/Left - Senza pastiglie/Without brake pads | 42548185 42536634 42535438 | 975106 |
|-----------------|--|----------------------------------|---------------|



| Connessione / Connected:  960973E3  960836 - 960715 - 960703 | | | |
|--|--|--|--|
|--|--|--|--|











I riferimenti indicati non sono originali ma perfettamente intercambiabili. I codici originali e le case costruttrici sono indicati a puro titolo informativo
The details described are not original but perfectly interchangeable. The original references and manufacturer names are given for information purposes only.

EMMERRE

spare parts for trucks and trailers

IVECO

PINZE FRENO BRAKE CALIPERS ETRIERS DE FREIN BREMSSATTEL СУППОРТА И РЕМОНТНЫЕ КОМПЛЕКТЫ PINZAS DE FRENO

| Emmerre | Adattabile a / Adaptable to | Dettagli / Detail | Applicazioni / Applications |
|---|--|--|-----------------------------|
| 975100  | 42560073 504139834 504120471 42555558 | - Anteriore/Front - Destra/Right - Senza pastiglie/Without brake pads | Daily M.Y. 2006 |
| Connessione / Connected:  960513E3  960016 - 960716 - 960717 - 960718 - 960719 | | | |
| 975101  | 42560072 504139833 504120470 42555557 | - Anteriore/Front - Sinistra/Left - Senza pastiglie/Without brake pads | Daily M.Y. 2006 |
| Connessione / Connected:  960513E3  960016 - 960716 - 960717 - 960718 - 960719 | | | |
| 975102  | 42554759 504120970 | - Posteriore/Rear - Destra/Right - Senza pastiglie/Without brake pads | Daily M.Y. 2006 |
| Connessione / Connected:  960516E3 | | | |
| 975103  | 42554758 504120969 | - Posteriore/Rear - Sinistra/Left - Senza pastiglie/Without brake pads | Daily M.Y. 2006 |
| Connessione / Connected:  960516E3 | | | |

**PINZE FRENO
BRAKE CALIPERS
ETRIERS DE FREIN
BREMSSATTEL
СУППОРТА И РЕМОНТНЫЕ КОМПЛЕКТЫ
PINZAS DE FRENO**

EMMERRE
spare parts for trucks and trailers

IVECO

| Applicazioni / Applications | Dettagli / Detail | Adattabile a / Adaptable to | Emmerre |
|---|---|--|--|
| Eurocargo 60/65/75 | - Anteriore/Front - Destra/Right - Senza pastiglie/Without brake pads | 42568970 42534120 42533001 42532305 | 975087  |
| Connessione / Connected:  960912E3  960847 - 960843 - 960837 - 960849  960036 | | | |
| Eurocargo 60/65/75 | - Anteriore/Front - Sinistra/Left - Senza pastiglie/Without brake pads | 42568969 42534119 42533000 42532304 | 975086  |
| Connessione / Connected:  960912E3  960847 - 960843 - 960837 - 960849  960036 | | | |
| Eurocargo 60/65/75 | - Posteriore/Rear - Destra/Right - Senza pastiglie/Without brake pads | 42568972 42534122 42533004 | 975089  |
| Connessione / Connected:  960912E3  960847 - 960843 - 960837 - 960849 - 960706  960036 | | | |
| Eurocargo 60/65/75 | - Posteriore/Rear - Sinistra/Left - Senza pastiglie/Without brake pads | 42568971 42534121 42533002 | 975088  |
| Connessione / Connected:  960912E3  960847 - 960843 - 960837 - 960849 - 960706  960036 | | | |

I riferimenti indicati non sono originali ma perfettamente intercambiabili. I codici originali e le case costruttrici sono indicati a puro titolo informativo
The details described are not original but perfectly interchangeable. The original references and manufacturer names are given for information purposes only.

EMMERRE

spare parts for trucks and trailers

IVECO

PINZE FRENO BRAKE CALIPERS ETRIERS DE FREIN BREMSSATTEL СУППОРТА И РЕМОНТНЫЕ КОМПЛЕКТЫ PINZAS DE FRENO

| Emmerre | Adattabile a / Adaptable to | Dettagli / Detail | Applicazioni / Applications |
|--|-----------------------------|---|--|
| 975200   | 42548180 504085823 | - Anteriore/Front - Destra/Right - Senza pastiglie/Without brake pads - Cilindro/Cylinder Ø 44 mm | Daily III |
| | | Connessione / Connected:  960923  960910E3 | |
| 975201   | 42548179 504085822 | - Anteriore/Front - Sinistra/Left - Senza pastiglie/Without brake pads - Cilindro/Cylinder Ø 44 mm | Daily III |
| | | Connessione / Connected:  960923  960910E3 | |
| 975132  | 42555559 504121785 | - Anteriore/Front - Sinistra/Left - Senza pastiglie/Without brake pads | Daily 65/70 C14/15/17/18 60C15/17/18 55C/17 |
| | | Connessione / Connected:  961015  960847-960837-960849 | |
| 975133  | 42555560 504121786 | - Anteriore/Front - Destra/Right - Senza pastiglie/Without brake pads | Daily 65/70 C14/15/17/18 60C15/17/18 55C/17 |
| | | Connessione / Connected:  961015  960847-960837-960849 | |

**PINZE FRENO
BRAKE CALIPERS
ETRIERS DE FREIN
BREMSSATTEL
СУППОРТА И РЕМОНТНЫЕ КОМПЛЕКТЫ
PINZAS DE FRENO**

EMMERRE
spare parts for trucks and trailers

IVECO

| Applicazioni / Applications | Dettagli / Detail | Adattabile a / Adaptable to | Emmerre |
|---|---|-----------------------------|---------------|
| Eurocargo 60/70 Tector 75 MY2008 Euro 6 | - Anteriore/Front - Sinistra/Left - Senza pastiglie/Without brake pads | 42559189 504234182 | 975121 |



| Connessione / Connected:  961033 | | | |
|---|--|--|--|
|---|--|--|--|

| | | | |
|---|--|-----------------------|---------------|
| Eurocargo 60/70 Tector 75 MY2008 Euro 6 | - Anteriore/Front - Destra/Right - Senza pastiglie/Without brake pads | 42559190 504234183 | 975122 |
|---|--|-----------------------|---------------|



| Connessione / Connected:  961033 | | | |
|---|--|--|--|
|---|--|--|--|

| | | | |
|---|---|-----------------------|---------------|
| Eurocargo 60/70 Tector 75 MY2008 Euro 6 | - Posteriore/Rear - Sinistra/Left - Senza pastiglie/Without brake pads | 42559201 504234189 | 975123 |
|---|---|-----------------------|---------------|



















| Connessione / Connected:  961033 | | | |
|---|--|--|--|
|---|--|--|--|

| | | | |
|---|--|-----------------------|---------------|
| Eurocargo 60/70 Tector 75 MY2008 Euro 6 | - Posteriore/Rear - Destra/Right - Senza pastiglie/Without brake pads | 42559202 504234190 | 975126 |
|---|--|-----------------------|---------------|



| Connessione / Connected:  961033 | | | |
|---|--|--|--|
|---|--|--|--|

I riferimenti indicati non sono originali ma perfettamente intercambiabili. I codici originali e le case costruttrici sono indicati a puro titolo informativo
The details described are not original but perfectly interchangeable. The original references and manufacturer names are given for information purposes only.

| Emmerre | Adattabile a / Adaptable to | Dettagli / Detail | Applicazioni / Applications |
|--|-----------------------------------|---|-----------------------------|
| 960453  | 42534116 42533006 | Anteriore/Front - Destra/Right - Senza pastiglie/Without brake pads | Eurocargo 80/100 |
| Connessione / Connected:  960939E3  960841 - 960847 - 960849  960036 | | | |
| 960452  | 42534115 42533005 | - Anteriore/Front - Sinistra/Left - Senza pastiglie/Without brake pads | Eurocargo 80/100 |
| Connessione / Connected:  960939E3  960841 - 960847 - 960849  960036 | | | |
| 975109  | 42534118 42533008 500352575 | - Posteriore/Rear - Destra/Right - Senza pastiglie/Without brake pads | Eurocargo 80/100 |
| Connessione / Connected:  960939E3  960841 - 960847 - 960849 - 960706  960037 | | | |
| 975108  | 42534117 42533007 500352574 | - Posteriore/Rear - Sinistra/Left - Senza pastiglie/Without brake pads | Eurocargo 80/100 |
| Connessione / Connected:  960939E3  960841 - 960847 - 960849 - 960706  960037 | | | |

**PINZE FRENO
BRAKE CALIPERS
ETRIERS DE FREIN
BREMSSATTEL
СУППОРТА И РЕМОНТНЫЕ КОМПЛЕКТЫ
PINZAS DE FRENO**

EMMERRE
spare parts for trucks and trailers

IVECO

| Applicazioni / Applications | Dettagli / Detail | Adattabile a / Adaptable to | Emmerre |
|---------------------------------------|---|-----------------------------|---------------|
| Eurocargo 100/120 Tector Euro 6 | - Anteriore/Front - Sinistra/Left - Senza pastiglie/Without brake pads | 42559199 504234186 | 975128 |



Connessione / Connected:  961034

| | | | |
|---------------------------------------|--|-----------------------|---------------|
| Eurocargo 100/120 Tector Euro 6 | - Anteriore/Front - Destra/Right - Senza pastiglie/Without brake pads | 42559200 504234187 | 975129 |
|---------------------------------------|--|-----------------------|---------------|



Connessione / Connected:  961034

| | | | |
|---------------------------------------|---|-----------------------|---------------|
| Eurocargo 100/120 Tector Euro 6 | - Posteriore/Rear - Sinistra/Left - Senza pastiglie/Without brake pads | 42559203 504234209 | 975130 |
|---------------------------------------|---|-----------------------|---------------|



Connessione / Connected:  961034

| | | | |
|---------------------------------------|--|-----------------------|---------------|
| Eurocargo 100/120 Tector Euro 6 | - Posteriore/Rear - Destra/Right - Senza pastiglie/Without brake pads | 42559204 504234210 | 975131 |
|---------------------------------------|--|-----------------------|---------------|



Connessione / Connected:  961034









I riferimenti indicati non sono originali ma perfettamente intercambiabili. I codici originali e le case costruttrici sono indicati a puro titolo informativo
The details described are not original but perfectly interchangeable. The original references and manufacturer names are given for information purposes only.

EMMERRE

spare parts for trucks and trailers

MERCEDES

PINZE FRENO
BRAKE CALIPERS
ETRIERS DE FREIN
BREMSSATTEL
СУППОРТА И РЕМОНТНЫЕ КОМПЛЕКТЫ
PINZAS DE FRENO

| Emmerre | Adattabile a / Adaptable to | Dettagli / Detail | Applicazioni / Applications |
|--|--|--|-----------------------------|
| 975112  | 6384230398 6384230198 6384230598 | - Posteriore/Rear - Sinistra/Left - Senza pastiglie/Without brake pads | Vito |
| Connessione / Connected:  960777 - 960926 | | | |
| 975113  | 6384230698 6384230298 6384230498 | - Posteriore/Rear - Destra/Right - Senza pastiglie/Without brake pads | Vito |
| Connessione / Connected:  960777 - 960926 | | | |
| 975110  | 0014208683 9044200801 0014206983 9024201101 | - Anteriore/Front - Posteriore/Rear - Sinistra/Left - Senza pastiglie/Without brake pads | Sprinter |
| Connessione / Connected:  960920E3 | | | |
| 975111  | 0014208783 9044200901 9024201201 | - Anteriore/Front - Posteriore/Rear - Destra/Right - Senza pastiglie/Without brake pads | Sprinter |
| Connessione / Connected:  960920E3 | | | |

**PINZE FRENO
BRAKE CALIPERS
ETRIERS DE FREIN
BREMSSATTEL
СУППОРТА И РЕМОНТНЫЕ КОМПЛЕКТЫ
PINZAS DE FRENO**

EMMERRE
spare parts for trucks and trailers

MERCEDES

| Applicazioni / Applications | Dettagli / Detail | Adattabile a / Adaptable to | Emmerre |
|-----------------------------|--|---|---------------|
| Sprinter 2006/2016 | - Anteriore/Front - Destra/Right - Senza pastiglie/Without brake pads - Cilindro/Cylinder Ø 48 mm | 0044205683 | 975190 |
| | |  | |
| Sprinter 2006/2016 | - Anteriore/Front - Sinistra/Left - Senza pastiglie/Without brake pads - Cilindro/Cylinder Ø 48 mm | 0044205583 | 975191 |
| | |  | |
| Sprinter 2006/2016 | - Anteriore/Front - Sinistra/Left - Senza pastiglie/Without brake pads - Cilindro/Cylinder Ø 52 mm | 0044205783 | 975192 |
| | |  | |
| Sprinter 2006/2016 | - Anteriore/Front - Destra/Right - Senza pastiglie/Without brake pads - Cilindro/Cylinder Ø 52 mm | 0044205883 | 975193 |
| | |  | |







I riferimenti indicati non sono originali ma perfettamente intercambiabili. I codici originali e le case costruttrici sono indicati a puro titolo informativo
The details described are not original but perfectly interchangeable. The original references and manufacturer names are given for information purposes only.

EMMERRE

spare parts for trucks and trailers

NISSAN







PINZE FRENO
BRAKE CALIPERS
ETRIERS DE FREIN
BREMSSATTEL
СУППОРТА И РЕМОНТНЫЕ КОМПЛЕКТЫ
PINZAS DE FRENO

| Emmerre | Adattabile a / Adaptable to | Dettagli / Detail | Applicazioni / Applications |
|---|-----------------------------|---|-----------------------------|
| 975350  | 41000G4802 | - Anteriore/Front - Sinistra/Left - Senza pastiglie/Without brake pads - Cylinder Ø 52 mm | Cabstar 110 Trade |
| Connessione / Connected:  960872E3 | | | |
| 975351  | 41000G4801 | - Anteriore/Front - Destra/Right - Senza pastiglie/Without brake pads - Cylinder Ø 52 mm | Cabstar 110 Trade |
| Connessione / Connected:  960872E3 | | | |
| 975352  | -06903085-0 41000F3901 | - Anteriore/Front - Sinistra/Left - Senza pastiglie/Without brake pads - Cylinder Ø 48 mm | Cabstar 110 Trade |
| 975353  | -06903084-0 41000F3902 | - Anteriore/Front - Destra/Right - Senza pastiglie/Without brake pads - Cylinder Ø 48 mm | Cabstar 110 Trade |

**PINZE FRENO
BRAKE CALIPERS
ETRIERS DE FREIN
BREMSSATTEL
СУППОРТА И РЕМОНТНЫЕ КОМПЛЕКТЫ
PINZAS DE FRENO**

EMMERRE
spare parts for trucks and trailers

NISSAN

| Applicazioni / Applications | Dettagli / Detail | Adattabile a / Adaptable to | Emmerre |
|--|---|---|---------------|
| Cabstar 120 Cabstar 35.13 | - Anteriore/Front - Sinistra/Left - Senza pastiglie/Without brake pads | 410119X225 | 975348 |
| | |  | |
| Cabstar 120 Cabstar 35.13 | - Anteriore/Front - Destra/Right - Senza pastiglie/Without brake pads | 410019X225 | 975349 |
| | |  | |
| Cabstar 45.13 Cabstar 45.15 | - Anteriore/Front - Destra/Right - Senza pastiglie/Without brake pads | 41001MB200 41001MB225 | 975105 |
| | |  | |
| Connessione / Connected:  960787-960714 | | | |
| Cabstar 45.13 Cabstar 45.15 | - Anteriore/Front - Sinistra/Left - Senza pastiglie/Without brake pads | 41011MB225 41011MB200 | 975104 |
| | |  | |
| Connessione / Connected:  960787-960714 | | | |

I riferimenti indicati non sono originali ma perfettamente intercambiabili. I codici originali e le case costruttrici sono indicati a puro titolo informativo
The details described are not original but perfectly interchangeable. The original references and manufacturer names are given for information purposes only.

EMMERRE

spare parts for trucks and trailers

NISSAN





PINZE FRENO
BRAKE CALIPERS
ETRIERS DE FREIN
BREMSSATTEL
СУППОРТА И РЕМОНТНЫЕ КОМПЛЕКТЫ
PINZAS DE FRENO

| Emmerre | Adattabile a / Adaptable to | Dettagli / Detail | Applicazioni / Applications |
|--|-----------------------------|---|---|
| 975172  | 44011MA00A | - Posteriore/Rear - Sinistra/Left - Senza pastiglie/Without brake pads | Cabstar 28.11 Cabstar 35.13/15 Cabstar 45.15 |
| | | | Connessione / Connected:  960459 |
| 975171  | 44001MA00A | - Posteriore/Rear - Destra/Right - Senza pastiglie/Without brake pads | Cabstar 28.11 Cabstar 35.13/15 Cabstar 45.15 |
| | | | Connessione / Connected:  960459 |
| 975360  | 4401100Q0C | - Posteriore/Rear - Sinistra/Left - Senza pastiglie/Without brake pads - Cylinder Ø 48 mm | NV400 |
| | | | Connessione / Connected:  960791 |
| 975361  | 4400100Q0D | - Posteriore/Rear - Destra/Right - Senza pastiglie/Without brake pads - Cylinder Ø 48 mm | NV400 |
| | | | Connessione / Connected:  960791 |

**PINZE FRENO
BRAKE CALIPERS
ETRIERS DE FREIN
BREMSSATTEL
СУППОРТА И РЕМОНТНЫЕ КОМПЛЕКТЫ
PINZAS DE FRENO**

EMMERRE
spare parts for trucks and trailers

NISSAN

| Applicazioni / Applications | Dettagli / Detail | Adattabile a / Adaptable to | Emmerre |
|---|--|-----------------------------------|---------------|
| NV400 2.3 DCI | <ul style="list-style-type: none"> - Posteriore/Rear - Sinistra/Left - Senza pastiglie/Without brake pads - Cylinder Ø 60 mm | 4401100Q0K 4401100Q0D | 975362 |
| Connessione / Connected:  960790 | | | |
| NV400 2.3 DCI | <ul style="list-style-type: none"> - Posteriore/Rear - Destra/Right - Senza pastiglie/Without brake pads - Cylinder Ø 60 mm | 4400100Q0J 4400100Q0C | 975363 |
| Connessione / Connected:  960790 | | | |
| Atleon 110 Atleon 120 | <ul style="list-style-type: none"> - Anteriore/Front - Sinistra/Left - Destra/Right - Senza pastiglie/Without brake pads | 411119X425 (DX) 41129X425 (SX) | 975355 |
| Connessione / Connected:  960872E3 | | | |
| Atleon 140 from 2003 | <ul style="list-style-type: none"> - Posteriore/Rear - Destra/Right - Senza pastiglie/Without brake pads - <u>Brembo system</u> | 440019X426 440019X425 | 975356 |
| Connessione / Connected:  960985E3 | | | |









EMMERRE

spare parts for trucks and trailers

NISSAN





PINZE FRENO
BRAKE CALIPERS
ETRIERS DE FREIN
BREMSSATTEL
СУППОРТА И РЕМОНТНЫЕ КОМПЛЕКТЫ
PINZAS DE FRENO

| Emmerre | Adattabile a / Adaptable to | Dettagli / Detail | Applicazioni / Applications |
|---|-----------------------------|--|--|
| 975357  | 440119X426 440119X425 | - Posteriore/Rear - Sinistra/Left - Senza pastiglie/Without brake pads - <u>Brembo system</u> | Atleon 140 from 2003 |
| Connessione / Connected:  960947E3 | | | |
| 975117  | 4400100QAA 4400100QAB | - Posteriore/Rear - Destra/Right - Senza pastiglie/Without brake pads | Interstar DCI 100/120 140 /90/80 |
| Connessione / Connected:  960985E3 | | | |
| 975116  | 4401100QAA 4401100QAB | - Posteriore/Rear - Sinistra/Left - Senza pastiglie/Without brake pads | Interstar DCI 100/120 140 /90/80 |
| Connessione / Connected:  960985E3 | | | |



**PINZE FRENO
BRAKE CALIPERS
ETRIERS DE FREIN
BREMSSATTEL
СУППОРТА И РЕМОНТНЫЕ КОМПЛЕКТЫ
PINZAS DE FRENO**

EMMERRE
spare parts for trucks and trailers

OPEL

| Applicazioni / Applications | Dettagli / Detail | Adattabile a / Adaptable to | Emmerre |
|---|---|-------------------------------|---------------|
| Movano Combi | - Posteriore/Rear - Destra/Right - Senza pastiglie/Without brake pads | 4403463 4405544 9111463 | 975117 |
| Connessione / Connected:  960985E3 | | | |
| Movano Combi | - Posteriore/Rear - Sinistra/Left - Senza pastiglie/Without brake pads | 4403459 4405539 9111459 | 975116 |
| Connessione / Connected:  960985E3 | | | |
| Movano B | - Posteriore/Rear - Sinistra/Left - Senza pastiglie/Without brake pads - Cylinder Ø 48 mm | 4420056 | 975360 |
| Connessione / Connected:  960791 | | | |
| Movano B | - Posteriore/Rear - Destra/Right - Senza pastiglie/Without brake pads - Cylinder Ø 48 mm | 4420057 | 975361 |
| Connessione / Connected:  960791 | | | |







| Emmerre | Adattabile a / Adaptable to | Dettagli / Detail | Applicazioni / Applications |
|--|-----------------------------|--|-----------------------------|
| 975362 | 4421281 | - <i>Posteriore/Rear</i> - <i>Sinistra/Left</i> - <i>Senza pastiglie/Without brake pads</i> - <i>Cylinder Ø 60 mm</i> | Movano B |
|  | | | |
| 975363 | 4421282 | - <i>Posteriore/Rear</i> - <i>Destra/Right</i> - <i>Senza pastiglie/Without brake pads</i> - <i>Cylinder Ø 60 mm</i> | Movano B |
|  | | | |

PINZE FRENO
BRAKE CALIPERS
ETRIERS DE FREIN
BREMSSATTEL
СУППОРТА И РЕМОНТНЫЕ КОМПЛЕКТЫ
PINZAS DE FRENO





EMMERRE
spare parts for trucks and trailers

RENAULT

| Applicazioni / Applications | Dettagli / Detail | Adattabile a / Adaptable to | Emmerre |
|---|---|--|---------------|
| Master III | <ul style="list-style-type: none"> - Posteriore/Rear - Sinistra/Left - Senza pastiglie/Without brake pads - Cylinder Ø 48 mm | 440118711R 440111516R | 975360 |
| Connessione / Connected:  960791 | | | |
| Master III | <ul style="list-style-type: none"> - Posteriore/Rear - Destra/Right - Senza pastiglie/Without brake pads - Cylinder Ø 48 mm | 440010814R 440014373R | 975361 |
| Connessione / Connected:  960791 | | | |
| Master III | <ul style="list-style-type: none"> - Posteriore/Rear - Sinistra/Left - Senza pastiglie/Without brake pads - Cylinder Ø 60 mm | 7485124347 440115651R 440116884R 7485135104 440118714R | 975362 |
| Connessione / Connected:  960790 | | | |
| Master III | <ul style="list-style-type: none"> - Posteriore/Rear - Destra/Right - Senza pastiglie/Without brake pads - Cylinder Ø 60 mm | 7485124349 440010724R 440011819R 7485135103 440016929R | 975363 |
| Connessione / Connected:  960790 | | | |







I riferimenti indicati non sono originali ma perfettamente intercambiabili. I codici originali e le case costruttrici sono indicati a puro titolo informativo
The details described are not original but perfectly interchangeable. The original references and manufacturer names are given for information purposes only.

| Emmerre | Adattabile a / Adaptable to | Dettagli / Detail | Applicazioni / Applications |
|---------------|-----------------------------|--|---|
| 975081 | 5001874363 | - Anteriore/ <i>Front</i> - Destra/ <i>Right</i> - Senza pastiglie/ <i>Without brake pads</i> | Mascott 120.35/55/65 160.35/55/65 |
| | | | Connessione / Connected:  960987E3 |
| 975080 | 5001874362 | - Anteriore/ <i>Front</i> - Sinistra/ <i>Left</i> - Senza pastiglie/ <i>Without brake pads</i> | Mascott 120.35/55/65 160.35/55/65 |
| | | | Connessione / Connected:  960987E3 |
| 975083 | 5001874365 | - Posteriore/ <i>Rear</i> - Destra/ <i>Right</i> - Senza pastiglie/ <i>Without brake pads</i> | Mascott 120.35/55/65 160.35/55/65 |
| | | | Connessione / Connected:  960987E3 |
| 975082 | 5001874364 | - Posteriore/ <i>Rear</i> - Sinistra/ <i>Left</i> - Senza pastiglie <i>Without brake pads</i> | Mascott 120.35/55/65 160.35/55/65 |
| | | | Connessione / Connected:  960987E3 |

**PINZE FRENO
BRAKE CALIPERS
ETRIERS DE FREIN
BREMSSATTEL
СУППОРТА И РЕМОНТНЫЕ КОМПЛЕКТЫ
PINZAS DE FRENO**



EMMERRE
spare parts for trucks and trailers

RENAULT

| Applicazioni / Applications | Dettagli / Detail | Adattabile a / Adaptable to | Emmerre |
|---|---|-----------------------------|---------------|
| Master Master II Master III | - Posteriore/Rear - Sinistra/Left - Senza pastiglie/Without brake pads | 7701206754 7701208036 | 975116 |
| Connessione / Connected:  960985E3 | | | |
| Master Master II Master III | - Posteriore/Rear - Destra/Right - Senza pastiglie/Without brake pads | 7701206755 7701208037 | 975117 |
| Connessione / Connected:  960985E3 | | | |
| Mascott 120.35 120.55/65 | - Posteriore/Rear - Destra/Right - Senza pastiglie/Without brake pads | 5001867384 | 975107 |
| Connessione / Connected:  960987E3 | | | |
| Mascott 120.35 120.55/65 | - Posteriore/Rear - Sinistra/Left - Senza pastiglie/Without brake pads | 5001867383 | 975106 |
| Connessione / Connected:  960987E3 | | | |



I riferimenti indicati non sono originali ma perfettamente intercambiabili. I codici originali e le case costruttrici sono indicati a puro titolo informativo
The details described are not original but perfectly interchangeable. The original references and manufacturer names are given for information purposes only.

| Emmerre | Adattabile a / <i>Adaptable to</i> | Dettagli / <i>Detail</i> | Applicazioni / <i>Applications</i> |
|---------------|------------------------------------|---|---|
| 975172 | 7485120001 5001872513 | - Posteriore/Rear - Sinistra/Left - Senza pastiglie/Without brake pads | Maxity |
| | | | Connessione / Connected:  960459 |
| 975171 | 7485120000 5001872515 | - Posteriore/Rear - Destra/Right - Senza pastiglie/Without brake pads | Maxity |
| | | | Connessione / Connected:  960459 |

PINZE FRENO
BRAKE CALIPERS
ETRIERS DE FREIN
BREMSSATTEL
СУППОРТА И РЕМОНТНЫЕ КОМПЛЕКТЫ
PINZAS DE FRENO



| Applicazioni / Applications | Dettagli / Detail | Adattabile a / Adaptable to | Emmerre |
|-----------------------------|-------------------|-----------------------------|---------|
|-----------------------------|-------------------|-----------------------------|---------|

| | | | |
|--|--|--|--|
| | | | |
|--|--|--|--|

| | | | |
|--|--|--|--|
| | | | |
|--|--|--|--|

| | | | |
|--|--|--|--|
| | | | |
|--|--|--|--|

| Emmerre | Adattabile a / <i>Adaptable to</i> | Dettagli / <i>Detail</i> | Applicazioni / <i>Applications</i> |
|--|------------------------------------|---|---|
| <p>960709</p>  | <p>0980106320</p> | <p>- Anteriore e posteriore/<i>Front and rear</i></p> | <p>Axle RS.-SB. 3745/4345</p> |
| | | | |
| | | | |
| | | | |

KIT REVISIONE PINZE FRENO
BRAKE CALIPERS REPAIRING KIT
KIT DE REPARATION POUR ETRIERES DE FREIN
REPARATURSATZ FÜR BREMSSEL
РЕМОНТНЫЕ КОМПЛЕКТЫ ДЛЯ СУППОРТОВ
KIT REPARACION PARA PINZAS DE FRENO

EMMERRE
 spare parts for trucks and trailers

DAF

| Applicazioni / Applications | Dettagli / Detail | Adattabile a / Adaptable to | Emmerre |
|-----------------------------|---|-------------------------------|--|
| Trucks | - Anteriore e posteriore/ <i>Front and Rear</i> | 1622785 1689313 1616894 | 960709  |
| Trucks | - Anteriore e posteriore/ <i>Front and Rear</i> | 1639100 | 960710  |
| Trucks | - Anteriore e posteriore/ <i>Front and Rear</i> | 1436853 | 960734  |
| Trucks | - Anteriore/ <i>Front</i> | 1690420 | 960731  |









I riferimenti indicati non sono originali ma perfettamente intercambiabili. I codici originali e le case costruttrici sono indicati a puro titolo informativo
 The details described are not original but perfectly interchangeable. The original references and manufacturer names are given for information purposes only.

EMMERRE

spare parts for trucks and trailers

IVECO





KIT REVISIONE PINZE FRENO BRAKE CALIPERS REPAIRING KIT KIT DE REPARATION POUR ETRIERES DE FREIN REPARATURSATZ FÜR BREMSSATTEL РЕМОНТНЫЕ КОМПЛЕКТЫ ДЛЯ СУППОРТОВ KIT REPARACION PARA PINZAS DE FRENO

| Emmerre | Adattabile a / Adaptable to | Dettagli / Detail | Applicazioni / Applications |
|---|-----------------------------|--|---------------------------------------|
| 960745  NEW | 42559213 | - Posteriore/Rear | Eurocargo 100/120 Tector Euro 6 |
| | | Connessione / Connected:  | 975130 -975131 |
| 965059  | 93160528 | - Anteriore/Front - Molla pinze freno/Brake caliper spring | Daily New Daily |
| | | Connessione / Connected:  | 965056 -965057 |
| 965058  | 93160526 | - Anteriore/Front - Perno calibrato/Calibrated pin | Daily New Daily |
| | | Connessione / Connected:  | 965056 -965057 |
| 960832  | 93161188 | - Anteriore/Front | Daily |
| | | Connessione / Connected:  | 965056 -965057 |

KIT REVISIONE PINZE FRENO
BRAKE CALIPERS REPAIRING KIT
KIT DE REPARATION POUR ETRIERS DE FREIN
REPARATURSATZ FÜR BREMSSEL
РЕМОНТНЫЕ КОМПЛЕКТЫ ДЛЯ СУППОРТОВ
KIT REPARACION PARA PINZAS DE FRENO

EMMERRE
 spare parts for trucks and trailers

IVECO

| Applicazioni / Applications | Dettagli / Detail | Adattabile a / Adaptable to | Emmerre |
|--|---|-----------------------------|--|
| Daily New Daily Turbodaily | - Anteriore/Front - Esterno <i>External</i> Ø mm. 44 - Altezza/ <i>Height</i> mm. 35 | 93161187 | 960848  |
| Connessione / Connected:  965056 - 965057 | | | |
| Daily Restyling New Daily New Daily '96 Turbodaily | - Anteriore/Front | 1902317 | 960889  |
| Connessione / Connected:  960372 - 960373 - 42532364 - 42532365 | | | |
| Daily New Daily | - Anteriore/Front - Esterno <i>External</i> Ø mm. 42 - Altezza/ <i>Height</i> mm. 35 | 93161568 | 960850  |
| Connessione / Connected:  960372 - 960373 - 42532364 - 42532365 - 42561697 - 42561698 | | | |
| New Daily Daily Restyling | - Anteriore/Front | 8121135 | 960846  |
| Connessione / Connected:  960372 - 960373 - 42532364 - 42532365 | | | |

I riferimenti indicati non sono originali ma perfettamente intercambiabili. I codici originali e le case costruttrici sono indicati a puro titolo informativo
 The details described are not original but perfectly interchangeable. The original references and manufacturer names are given for information purposes only.

EMMERRE

spare parts for trucks and trailers

IVECO

KIT REVISIONE PINZE FRENO BRAKE CALIPERS REPAIRING KIT KIT DE REPARATION POUR ETRIERES DE FREIN REPARATURSATZ FÜR BREMSSATTEL РЕМОНТНЫЕ КОМПЛЕКТЫ ДЛЯ СУППОРТОВ KIT REPARACION PARA PINZAS DE FRENO

| Emmerre | Adattabile a / Adaptable to | Dettagli / Detail | Applicazioni / Applications |
|--|-----------------------------|---|------------------------------|
| 960830 | 93161567 | - Anteriore/Front | Daily |
|  | | | |
| Connessione / Connected:  960372 - 960373 | | | |
| 960713 | 93156966 | - Anteriore/Front - Esterno/External Ø mm. 42 - Altezza/Height mm. 35 | New Daily Daily Restyling |
|  | | | |
| Connessione / Connected:  960372 - 960373 | | | |
| 960829 | 42556251 42530365 | - Molla pinze freno/ Brake caliper spring | Daily City 2000 Daily '96 |
|  | | | |
| Connessione / Connected:  975080 - 975081 - 975082 - 975083 | | | |
| 960834 | 93161847 | - Anteriore e posteriore/Front and rear | Daily City 2000 Daily '96 |
|  | | | |
| Connessione / Connected:  975080 - 975081 - 975082 - 975083 | | | |

KIT REVISIONE PINZE FRENO
BRAKE CALIPERS REPAIRING KIT
KIT DE REPARATION POUR ETRIER DE FREIN
REPARATURSATZ FÜR BREMSSEL
РЕМОНТНЫЕ КОМПЛЕКТЫ ДЛЯ СУППОРТОВ
KIT REPARACION PARA PINZAS DE FRENO

EMMERRE
 spare parts for trucks and trailers

IVECO

| Applicazioni / Applications | Dettagli / Detail | Adattabile a / Adaptable to | Emmerre |
|---|---|-----------------------------|---------------|
| Daily City 2000 | - Anteriore e posteriore/ <i>Front and Rear</i> - Cuffie e tappo pinze freno/ <i>Brake caliper protective hoods and caps</i> | -- | 960742 |
|  | | | |
| Connessione / Connected: | 975080 - 975081 - 975082 - 975083 | | |
| Daily Daily '96 Daily City 2000 | - Anteriore e posteriore/ <i>Front and rear</i> | 93161849 | 960828 |
|  | | | |
| Connessione / Connected: | 975080 - 975081 - 975082 - 975083 - 975119 - 975120 | | |
| Daily Daily '96 Daily City 2000 | - Anteriore e posteriore/ <i>Front and rear</i> | 93162193 | 960703 |
|  | | | |
| Connessione / Connected: | 975080 - 975081 - 975082 - 975083 | | |
| Daily Daily '96 Daily City 2000 | - Anteriore e posteriore/ <i>Front and rear</i> - Esterno/ <i>External</i> Ø mm. 44 - Altezza/ <i>Height</i> mm. 61,50 | 42548327 93161848 | 960700 |
|  | | | |
| Connessione / Connected: | 975080 - 975081 - 975082 - 975083 - 975119 - 975120 | | |
|  | | | |
|  | | | |









I riferimenti indicati non sono originali ma perfettamente intercambiabili. I codici originali e le case costruttrici sono indicati a puro titolo informativo
 The details described are not original but perfectly interchangeable. The original references and manufacturer names are given for information purposes only.

EMMERRE

spare parts for trucks and trailers

IVECO









KIT REVISIONE PINZE FRENO BRAKE CALIPERS REPAIRING KIT KIT DE REPARATION POUR ETRIERES DE FREIN REPARATURSATZ FÜR BREMSSATTEL РЕМОНТНЫЕ КОМПЛЕКТЫ ДЛЯ СУППОРТОВ KIT REPARACION PARA PINZAS DE FRENO

| Emmerre | Adattabile a / Adaptable to | Dettagli / Detail | Applicazioni / Applications |
|--|-----------------------------|--|--|
| 960930  | 1902316 | - Anteriore/Front | Daily Restyling New Daily Turbodaily |
| Connessione / Connected:  8581657 - 8581658 - 93807093 - 93807094 - 93807099 - 93807100 | | | |
| 960090  | 93160388 | - Anteriore/Front - Molla pinze freno/ Brake caliper spring | Turbodaily '96 |
| Connessione / Connected:  975084 - 975085 | | | |
| 960091  | 93160389 | - Anteriore/Front - Perno pinze freno/ Brake caliper pin | Turbodaily '96 |
| Connessione / Connected:  975084 - 975085 | | | |
| 960017  | 93161181 | - Anteriore/Front | Daily '96 |
| Connessione / Connected:  975084 - 975085 | | | |

KIT REVISIONE PINZE FRENO
BRAKE CALIPERS REPAIRING KIT
KIT DE REPARATION POUR ETRIER DE FREIN
REPARATURSATZ FÜR BREMSSEL
РЕМОНТНЫЕ КОМПЛЕКТЫ ДЛЯ СУППОРТОВ
KIT REPARACION PARA PINZAS DE FRENO

EMMERRE
 spare parts for trucks and trailers

IVECO

| Applicazioni / Applications | Dettagli / Detail | Adattabile a / Adaptable to | Emmerre |
|---|---|-----------------------------|--|
| Turbodaily '96 | <ul style="list-style-type: none"> - Anteriore/Front - Kit pistoni pinze freno/Brake caliper piston kit - Esterno/External Ø mm. 50 - Altezza/Height mm. 38 | 93160387 |  960026 |
| Connessione / Connected:  975084 - 975085 | | | |
| Daily City 2000 | - Molla pinze freno/Brake caliper spring | 42555414 |  965060 |
| Connessione / Connected:  975092 -975093 | | | |
| Daily City 2000 | <ul style="list-style-type: none"> - Posteriore/Rear - Sinistro/Left | -- |  960749 |
| Connessione / Connected:  975092 | | | |
| Daily City 2000 | <ul style="list-style-type: none"> - Posteriore/Rear - Destro/Right | -- |  960748 |
| Connessione / Connected:  975093 | | | |









I riferimenti indicati non sono originali ma perfettamente intercambiabili. I codici originali e le case costruttrici sono indicati a puro titolo informativo
 The details described are not original but perfectly interchangeable. The original references and manufacturer names are given for information purposes only.

| Emmerre | Adattabile a / Adaptable to | Dettagli / Detail | Applicazioni / Applications |
|--|-----------------------------|---|-----------------------------|
| 960746 | -- | - Posteriore/Rear | Daily City 2000 |
|  | | | |
| Connessione / Connected:  975092 - 975093 | | | |
| 960719 | 42555416 42548197 | - Posteriore/Rear | Daily M.Y. 2006 |
|  | | | |
| Connessione / Connected:  975092 - 975093 | | | |
| 960744 | -- | - Posteriore/Rear - Pistone pinza freno/Brake caliper piston - Esterno/External Ø mm. 52 - Altezza/Height mm. 65 | Daily City 2000 |
|  | | | |
| Connessione / Connected:  975092 - 975093 | | | |
| 960720 | 42555418 93162295 | - Posteriore/Rear | Daily M.Y. 2006 |
|  | | | |
| Connessione / Connected:  975092 - 975093 | | | |

KIT REVISIONE PINZE FRENO
BRAKE CALIPERS REPAIRING KIT
KIT DE REPARATION POUR ETRIER DE FREIN
REPARATURSATZ FÜR BREMSSEL
РЕМОНТНЫЕ КОМПЛЕКТЫ ДЛЯ СУППОРТОВ
KIT REPARACION PARA PINZAS DE FRENO

EMMERRE
 spare parts for trucks and trailers

IVECO

| Applicazioni / Applications | Dettagli / Detail | Adattabile a / Adaptable to | Emmerre |
|--|--|-----------------------------|--|
| Daily M.Y. 2006 | - Posteriore/Rear | 42555419 93162294 | 960721  |
| Connessione / Connected:  975092 - 975093 | | | |
| Daily M.Y. 2006 | - Anteriore e posteriore/Front and Rear | 42555417 93162192 | 960016  |
| Connessione / Connected:  975092 - 975093 - 975104 - 975105 - 975106 - 975107 - 975119 - 975120 | | | |
| Connessione / Connected:  975090 - 975091 - 975100 - 975101 | | | |
| Daily Serie C | - Posteriore/Rear | 42556206 | 960743  |
| Connessione / Connected:  975102 - 975103 | | | |
| Daily City 2000 | - Posteriore/Rear | 42555420 42537599 | 960740  |
| Connessione / Connected:  975102 - 975103 | | | |

I riferimenti indicati non sono originali ma perfettamente intercambiabili. I codici originali e le case costruttrici sono indicati a puro titolo informativo
 The details described are not original but perfectly interchangeable. The original references and manufacturer names are given for information purposes only.

KIT REVISIONE PINZE FRENO BRAKE CALIPERS REPAIRING KIT KIT DE REPARATION POUR ETRIERES DE FREIN REPARATURSATZ FÜR BREMSSATTEL РЕМОНТНЫЕ КОМПЛЕКТЫ ДЛЯ СУППОРТОВ KIT REPARACION PARA PINZAS DE FRENO

| Emmerre | Adattabile a / Adaptable to | Dettagli / Detail | Applicazioni / Applications |
|--|-----------------------------|---|---|
| 960756 | -- | - Posteriore/Rear - Kit riparazione pinze freno/ <i>Brake caliper repairing kit</i> - Sinistra e destra/ <i>Left and right</i> | Daily 35C10 35C12 35C15 35C18 |
|  | | | |
| Connessione / Connected:  975102 - 975103 | | | |
| 960758 | -- | - Posteriore/Rear - Destra/ <i>Right</i> | Daily 35C10 35C12 35C15 35C18 |
|  | | | |
| Connessione / Connected:  975102 | | | |
| 960759 | -- | - Posteriore/Rear - Sinistra/ <i>Left</i> | Daily 35C10 35C12 35C15 35C18 |
|  | | | |
| Connessione / Connected:  975103 | | | |
| 960754 | -- | - Pistone/Piston - Esterno/ <i>External</i> Ø mm. 60 - Altezza/ <i>Height</i> mm. 65 | Daily 2006 |
|  | | | |
| Connessione / Connected:  975102 - 975103 | | | |

KIT REVISIONE PINZE FRENO
BRAKE CALIPERS REPAIRING KIT
KIT DE REPARATION POUR ETRIERES DE FREIN
REPARATURSATZ FÜR BREMSSEL
РЕМОНТНЫЕ КОМПЛЕКТЫ ДЛЯ СУППОРТОВ
KIT REPARACION PARA PINZAS DE FRENO

EMMERRE
 spare parts for trucks and trailers

IVECO

| Applicazioni / Applications | Dettagli / Detail | Adattabile a / Adaptable to | Emmerre |
|-----------------------------|---|-----------------------------|---------------|
| Daily City 2000 | - Anteriore/Front - Molla pinze freno/Brake caliper spring | 42556252 42535783 | 960739 |



| Connessione / Connected: | 975104 - 975105 | | |
|--------------------------|-----------------|--|--|
|--------------------------|-----------------|--|--|

| | | | |
|-----------------|-------------------|----------|---------------|
| Daily City 2000 | - Anteriore/Front | 42535784 | 960835 |
|-----------------|-------------------|----------|---------------|



| Connessione / Connected: | 975104 - 975105 | | |
|--------------------------|-----------------|--|--|
|--------------------------|-----------------|--|--|

| | | | |
|-----------------|--|----------------------|---------------|
| Daily City 2000 | - Anteriore/Front - Esterno/External Ø mm. 52 - Altezza/Height mm. 60,50 | 42548325 42535785 | 960714 |
|-----------------|--|----------------------|---------------|



| Connessione / Connected: | 975104 - 975105 | | |
|--------------------------|-----------------|--|--|
|--------------------------|-----------------|--|--|

| | | | |
|-----------------|-------------------|----------|---------------|
| Daily City 2000 | - Posteriore/Rear | 42535792 | 960836 |
|-----------------|-------------------|----------|---------------|



| Connessione / Connected: | 975106 - 975107 | | |
|--------------------------|-----------------|--|--|
|--------------------------|-----------------|--|--|

I riferimenti indicati non sono originali ma perfettamente intercambiabili. I codici originali e le case costruttrici sono indicati a puro titolo informativo
 The details described are not original but perfectly interchangeable. The original references and manufacturer names are given for information purposes only.

KIT REVISIONE PINZE FRENO
BRAKE CALIPERS REPAIRING KIT
KIT DE REPARATION POUR ETRIERES DE FREIN
REPARATURSATZ FÜR BREMSSATTEL
РЕМОНТНЫЕ КОМПЛЕКТЫ ДЛЯ СУППОРТОВ
KIT REPARACION PARA PINZAS DE FRENO

| Emmerre | Adattabile a / Adaptable to | Dettagli / Detail | Applicazioni / Applications |
|---|-----------------------------|---|--|
| 960715 | 42548326 42535793 | - Posteriore/Rear - Esterno/External Ø mm. 46 - Altezza/Height mm. 59,50 | Daily City 2000 |
|  | | | |
| | | | Connessione / Connected:  975107 - 975106 |
| 960716 | 42555882 | - Anteriore/Front | Daily M.Y. 2006 |
|  | | | |
| | | | Connessione / Connected:  975101 - 975100 |
| 960717 | 42555883 | - Anteriore/Front | Daily M.Y. 2006 |
|  | | | |
| | | | Connessione / Connected:  975101 - 975100 |
| 960718 | 42555884 | - Anteriore/Front - Esterno/External Ø mm. 48 - Altezza/Height mm. 59,50 | Daily M.Y. 2006 |
|  | | | |
| | | | Connessione / Connected:  975101 - 975100 |

KIT REVISIONE PINZE FRENO
BRAKE CALIPERS REPAIRING KIT
KIT DE REPARATION POUR ETRIERES DE FREIN
REPARATURSATZ FÜR BREMSSEL
РЕМОНТНЫЕ КОМПЛЕКТЫ ДЛЯ СУППОРТОВ
KIT REPARACION PARA PINZAS DE FRENO

EMMERRE
 spare parts for trucks and trailers

IVECO

| Applicazioni / Applications | Dettagli / Detail | Adattabile a / Adaptable to | Emmerre |
|-----------------------------|-------------------|-----------------------------|---------------|
| Daily M.Y. 2006 | - Anteriore/Front | 93162191 | 960727 |



| | | | |
|--|--|--|--|
| Connessione / Connected:  975119 - 975120 | | | |
|--|--|--|--|

| | | | |
|-----------------|-------------------|----------|---------------|
| Daily City 2000 | - Anteriore/Front | 93162189 | 960833 |
|-----------------|-------------------|----------|---------------|



| | | | |
|--|--|--|--|
| Connessione / Connected:  975119 - 975120 | | | |
|--|--|--|--|

| | | | |
|-----------------|--|----------|---------------|
| Daily City 2000 | - Anteriore/Front - Kit pistoni pinze freno/Brake caliper piston kit - Esterno/External Ø mm. 42 - Altezza/Height mm. 53,50 | 93162190 | 960726 |
|-----------------|--|----------|---------------|



| | | | |
|--|--|--|--|
| Connessione / Connected:  975119 - 975120 | | | |
|--|--|--|--|

| | | | |
|-----------------|--|----------|---------------|
| Daily M.Y. 2006 | - Posteriore/Rear - Kit ricambio molle pinze freno/Brake caliper spring replacement kit | 42555635 | 960013 |
|-----------------|--|----------|---------------|



| | | | |
|--|--|--|--|
| Connessione / Connected:  975090 - 975091 | | | |
|--|--|--|--|









I riferimenti indicati non sono originali ma perfettamente intercambiabili. I codici originali e le case costruttrici sono indicati a puro titolo informativo
 The details described are not original but perfectly interchangeable. The original references and manufacturer names are given for information purposes only.

EMMERRE

spare parts for trucks and trailers

IVECO

KIT REVISIONE PINZE FRENO BRAKE CALIPERS REPAIRING KIT KIT DE REPARATION POUR ETRIERES DE FREIN REPARATURSATZ FÜR BREMSSATTEL РЕМОНТНЫЕ КОМПЛЕКТЫ ДЛЯ СУППОРТОВ KIT REPARACION PARA PINZAS DE FRENO

| Emmerre | Adattabile a / Adaptable to | Dettagli / Detail | Applicazioni / Applications |
|--|-----------------------------|---|-----------------------------|
| 960015 | 42555636 | - Posteriore/Rear | Daily M.Y. 2006 |
|  | | | |
| Connessione / Connected:  975090 -975091 | | | |
| 960014 | 42555637 | - Posteriore/Rear - Kit pistoni pinze freno/Brake caliper piston kit - Esterno/External Ø mm. 48 - Altezza/Height mm. 64 | Daily M.Y. 2006 |
|  | | | |
| Connessione / Connected:  975090 -975091 | | | |
| 960725 | 8124032 | - Anteriore/Front | Turbozeta Zeta |
|  | | | |
| Connessione / Connected:  4824821 -4824822 - 7169623 - 7169624 | | | |
| 960082 | 8124735 | - Anteriore/Front | Eurocargo Gammazeta |
|  | | | |
| Connessione / Connected:  4830046 -4830047 | | | |

KIT REVISIONE PINZE FRENO
BRAKE CALIPERS REPAIRING KIT
KIT DE REPARATION POUR ETRIERES DE FREIN
REPARATURSATZ FÜR BREMSSEL
РЕМОНТНЫЕ КОМПЛЕКТЫ ДЛЯ СУППОРТОВ
KIT REPARACION PARA PINZAS DE FRENO

EMMERRE
 spare parts for trucks and trailers

IVECO

| Applicazioni / Applications | Dettagli / Detail | Adattabile a / Adaptable to | Emmerre |
|-----------------------------|---|-----------------------------|---------------|
| Eurocargo Tector | - Anteriore e posteriore/ <i>Front and rear</i> - Molla pinze freno/ <i>Brake caliper spring</i> | 93191658 | 960004 |



| Connessione / Connected:  4845536 - 4845537 | | | |
|--|--|----------|---------------|
| Eurocargo Tector | - Perno calibrato pinze freno/ <i>Brake caliper calibrated pin</i> | 93191659 | 960005 |



| Connessione / Connected:  4845536 - 4845537 | | | |
|--|---|----------|---------------|
| Eurocargo | - Anteriore e posteriore/ <i>Front and rear</i> | 93161429 | 960077 |











| Connessione / Connected:  4845536 - 4845537 | | | |
|--|---|----------|---------------|
| Eurocargo Tector | - Anteriore e posteriore/ <i>Front e rear</i> - Kit pistoni pinze freno/ <i>Brake caliper piston kit</i> - Esterno/ <i>External</i> Ø mm. 68 - Altezza/ <i>Height</i> mm. 39 | 93162033 | 960009 |

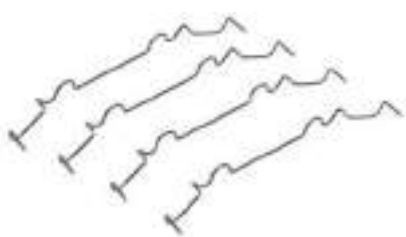

| Connessione / Connected:  4845536 - 4845537 | | | |
|--|--|--|--|
|--|--|--|--|

I riferimenti indicati non sono originali ma perfettamente intercambiabili. I codici originali e le case costruttrici sono indicati a puro titolo informativo
 The details described are not original but perfectly interchangeable. The original references and manufacturer names are given for information purposes only.







597

| Emmerre | Adattabile a / Adaptable to | Dettagli / Detail | Applicazioni / Applications |
|--|-----------------------------|---|----------------------------------|
| 960705 | 93161976 | - Anteriore/Front | Eurocargo |
|  | | | |
| Connessione / Connected:  975086 - 975087 | | | |
| 960847 | 93161757 | - Anteriore e posteriore/Front and rear | Eurocargo Eurocargo Tector |
|  | | | |
| Connessione / Connected:  960452 - 960453 - 975086 - 975087 - 975088 - 975089 - 975108 - 975109 - 975132 - 975133 | | | |
| 960837 | 93162075 | - Anteriore e posteriore/Front and rear | Eurocargo |
|  | | | |
| Connessione / Connected:  975086 - 975087 - 975088 - 975089 - 42555560 - 42555561 - 975132 - 975133 | | | |
| 960843 | 93162043 93161871 | - Anteriore e posteriore/Front and rear | Eurocargo |
|  | | | |
| Connessione / Connected:  975087 - 975088 - 975089 - 975086 | | | |

KIT REVISIONE PINZE FRENO
BRAKE CALIPERS REPAIRING KIT
KIT DE REPARATION POUR ETRIER DE FREIN
REPARATURSATZ FÜR BREMSSEL
РЕМОНТНЫЕ КОМПЛЕКТЫ ДЛЯ СУППОРТОВ
KIT REPARACION PARA PINZAS DE FRENO

EMMERRE
 spare parts for trucks and trailers

IVECO

| Applicazioni / Applications | Dettagli / Detail | Adattabile a / Adaptable to | Emmerre |
|---|---|-----------------------------|---------------|
| Eurocargo Eurocargo Tector | - Anteriore e posteriore/ <i>Front and rear</i> | 93161759 | 960849 |
|  Connessione / Connected: 960452 - 960453 - 975086 - 975087 - 975088 - 975089 - 975108 - 975109 - 975132 - 975133 | | | |
| Eurocargo | - Anteriore e posteriore/ <i>Front and rear</i> - Pistone pinza freno/ <i>Brake caliper piston</i> - Esterno/ <i>External</i> Ø mm. 60 - Altezza/ <i>Height</i> mm. 65 | 42530519 | 960711 |
|  Connessione / Connected:  975088 - 975089 - 975086 - 975087 | | | |
| Eurocargo | - Posteriore/ <i>Rear</i> - Pistone pinza freno/ <i>Brake caliper piston</i> - Esterno/ <i>External</i> Ø mm. 60 - Altezza/ <i>Height</i> mm. 65 | 42530520 | 960712 |
|  Connessione / Connected:  975088 - 975089 | | | |
| Eurocargo | - Anteriore e posteriore/ <i>Front and rear</i> | 93162076 | 960841 |
|  Connessione / Connected:  960452 - 960453 - 975108 - 975109 | | | |

I riferimenti indicati non sono originali ma perfettamente intercambiabili. I codici originali e le case costruttrici sono indicati a puro titolo informativo
 The details described are not original but perfectly interchangeable. The original references and manufacturer names are given for information purposes only.

KIT REVISIONE PINZE FRENO
BRAKE CALIPERS REPAIRING KIT
KIT DE REPARATION POUR ETRIERES DE FREIN
REPARATURSATZ FÜR BREMSSATTEL
РЕМОНТНЫЕ КОМПЛЕКТЫ ДЛЯ СУППОРТОВ
KIT REPARACION PARA PINZAS DE FRENO

| Emmerre | Adattabile a / Adaptable to | Dettagli / Detail | Applicazioni / Applications |
|--|-----------------------------|---|----------------------------------|
| 960078 | 93162044 93161758 | - Anteriore e posteriore/ <i>Front and rear</i> | Eurocargo |
|  | | | |
| Connessione / Connected:  960452 - 960453 - 975108 - 975109 | | | |
| 960722 | 93193784 | - Anteriore e posteriore/ <i>Front and rear</i> - Pistone pinza freno/ <i>Brake caliper piston</i> - Esterno/ <i>External</i> Ø mm. 68 - Altezza/ <i>Height</i> mm. 65 | Eurocargo Tector |
|  | | | |
| Connessione / Connected:  975108 - 975109 - 960452 - 960453 | | | |
| 960723 | 93193785 | - Posteriore/ <i>Rear</i> - Pistone pinza freno/ <i>Brake caliper piston</i> - Esterno/ <i>External</i> Ø mm. 68 - Altezza/ <i>Height</i> mm. 65 | Eurocargo Eurocargo Tector |
|  | | | |
| Connessione / Connected:  975108 - 975109 | | | |
| 960706 | 93161977 | - Posteriore/ <i>Rear</i> | Eurocargo |
|  | | | |
| Connessione / Connected:  975088 - 975089 - 975108 - 975109 | | | |

KIT REVISIONE PINZE FRENO
BRAKE CALIPERS REPAIRING KIT
KIT DE REPARATION POUR ETRIERES DE FREIN
REPARATURSATZ FÜR BREMSSEL
РЕМОНТНЫЕ КОМПЛЕКТЫ ДЛЯ СУППОРТОВ
KIT REPARACION PARA PINZAS DE FRENO

EMMERRE
 spare parts for trucks and trailers

IVECO

| Applicazioni / Applications | Dettagli / Detail | Adattabile a / Adaptable to | Emmerre |
|---|--|-----------------------------|---------------|
| Eurocargo | - Posteriore/Rear | 93161471 93161034 | 960083 |
|  | | | |
| Connessione / Connected: 4832624 - 4832625 | | | |
| Eurocargo | - Posteriore/Rear | 93161475 93161035 | 960084 |
|  | | | |
| Connessione / Connected: 4832624 - 4832625 | | | |
| Eurocargo Tector Gammazeta | - Anteriore e posteriore/Front and rear - Pistone pinza freno/Brake caliper piston - Esterno/External Ø mm. 68 - Altezza/Height mm. 65 | 93159285 | 960079 |
|  | | | |
| Connessione / Connected: 4830046 - 4830047 - 4832624 - 4832625 | | | |
| Eurocargo | - Posteriore/Rear - Pistone pinza freno/Brake caliper piston - Esterno/External Ø mm. 68 - Altezza/Height mm. 72 | 93161244 | 960080 |
|  | | | |
| Connessione / Connected: 4832624 - 4832625 | | | |









I riferimenti indicati non sono originali ma perfettamente intercambiabili. I codici originali e le case costruttrici sono indicati a puro titolo informativo
 The details described are not original but perfectly interchangeable. The original references and manufacturer names are given for information purposes only.

EMMERRE

spare parts for trucks and trailers

IVECO

KIT REVISIONE PINZE FRENO BRAKE CALIPERS REPAIRING KIT KIT DE REPARATION POUR ETRIERS DE FREIN REPARATURSATZ FÜR BREMSSATTEL РЕМОНТНЫЕ КОМПЛЕКТЫ ДЛЯ СУППОРТОВ KIT REPARACION PARA PINZAS DE FRENO

| Emmerre | Adattabile a / Adaptable to | Dettagli / Detail | Applicazioni / Applications |
|---|-----------------------------|--|-----------------------------|
| 960728 | 93191505 93161036 | - Posteriore/Rear | Eurocargo |
|  | | | |
| Connessione / Connected:  4832627 - 4832628 | | | |
| 960729 | 93161245 93161040 | - Posteriore/Rear - Esterno/External Ø mm. 60 - Altezza/Height mm. 63 | Eurocargo |
|  | | | |
| Connessione / Connected:  4832627 - 4832628 | | | |
| 960730 | 93161473 93161037 | - Posteriore/Rear | Eurocargo |
|  | | | |
| Connessione / Connected:  4832627 - 4832628 | | | |
| 960738 | 42530548 | - Anteriore e posteriore/Front and rear - Pistone pinze freno/Brake caliper piston - Esterno/External Ø mm. 60 - Altezza/Height mm. 63,50 | Eurocargo |
|  | | | |
| Connessione / Connected:  4832627 - 4832628 - 4830626 - 4830627 | | | |

KIT REVISIONE PINZE FRENO
BRAKE CALIPERS REPAIRING KIT
KIT DE REPARATION POUR ETRIERES DE FREIN
REPARATURSATZ FÜR BREMSSEL
РЕМОНТНЫЕ КОМПЛЕКТЫ ДЛЯ СУППОРТОВ
KIT REPARACION PARA PINZAS DE FRENO

EMMERRE
 spare parts for trucks and trailers

IVECO

| Applicazioni / Applications | Dettagli / Detail | Adattabile a / Adaptable to | Emmerre |
|-----------------------------|---|-----------------------------|---------------|
| Eurocargo | - Anteriore e posteriore / Front and rear | 42536957 | 960734 |



| | | | |
|---|--|--|--|
| Conessione / Connected:  500328232 - 500328234 | | | |
|---|--|--|--|

| | | | |
|-----------|---|----------|---------------|
| Eurocargo | - Anteriore e posteriore / Front and rear | 42537451 | 960735 |
|-----------|---|----------|---------------|



| | | | |
|---|--|--|--|
| Conessione / Connected:  99483108 - 99483109 - 41033394 - 41033395 | | | |
|---|--|--|--|

| | | | |
|-----------|----|----------|---------------|
| Eurocargo | -- | 42559195 | 960741 |
|-----------|----|----------|---------------|



| | | | |
|---|--|--|--|
| Conessione / Connected:  975128 - 975129 - 975130 - 975131 | | | |
|---|--|--|--|

| | | | |
|--------------------------------------|---------------------|----------|---------------|
| Eurocargo Eurotech Eurotrakker | - Anteriore / Front | 42538003 | 960081 |
|--------------------------------------|---------------------|----------|---------------|



| | | | |
|---|--|--|--|
| Conessione / Connected:  99458477 - 99458478 | | | |
|---|--|--|--|







I riferimenti indicati non sono originali ma perfettamente intercambiabili. I codici originali e le case costruttrici sono indicati a puro titolo informativo
 The details described are not original but perfectly interchangeable. The original references and manufacturer names are given for information purposes only.

EMMERRE

spare parts for trucks and trailers

IVECO







KIT REVISIONE PINZE FRENO BRAKE CALIPERS REPAIRING KIT KIT DE REPARATION POUR ETRIERES DE FREIN REPARATURSATZ FÜR BREMSSATTEL РЕМОНТНЫЕ КОМПЛЕКТЫ ДЛЯ СУППОРТОВ KIT REPARACION PARA PINZAS DE FRENO

| Emmerre | Adattabile a / Adaptable to | Dettagli / Detail | Applicazioni / Applications |
|--|-----------------------------|---|---|
| 960708  | 42562855 42538002 | - Anteriore/Front | Eurocargo Eurostar Eurotech Eurotrakker Cursor Tector Stralis |
| Connessione / Connected:  99458477 - 99458478 | | | |
| 960731  | 42553530 93162050 | - Anteriore/Front | Eurocargo Eurotech Eurotrakker Cursor Strali |
| Connessione / Connected:  99458477 - 99458478 | | | |
| 960709  | 42552622 42541413 | - Anteriore e posteriore/Front and rear | Eurocargo Eurostar Eurotech Eurotrakker Cursor Tector Stralis |
| Connessione / Connected:  41211269 - 41211270 | | | |
| 960710  | 42562856 42541412 | - Anteriore e posteriore/Front and rear | Eurocargo Eurostar Eurotech Eurotrakker Cursor Tector Stralis |
| Connessione / Connected:  41211269 - 41211270 | | | |

KIT REVISIONE PINZE FRENO
BRAKE CALIPERS REPAIRING KIT
KIT DE REPARATION POUR ETRIERS DE FREIN
REPARATURSATZ FÜR BREMSSEL
РЕМОНТНЫЕ КОМПЛЕКТЫ ДЛЯ СУППОРТОВ
KIT REPARACION PARA PINZAS DE FRENO







EMMERRE
 spare parts for trucks and trailers

IVECO

| Applicazioni / Applications | Dettagli / Detail | Adattabile a / Adaptable to | Emmerre |
|--|-------------------|-----------------------------|---------------|
| Eurocargo Eurostar Eurotech | - Anteriore/Front | 93161908 | 960085 |
|  | | | |
| Connessione / Connected:  98417402 - 98417403 - 98447620 - 98447621 | | | |
| Eurocargo Eurostar Eurotech | - Anteriore/Front | 93161559 | 960086 |
|  | | | |
| Connessione / Connected:  98479614 - 98479613 - 98417402 - 98417403 - 98447620 - 98447621 | | | |
| Eurocargo Eurostar Eurotech | -- | 93161192 | 960087 |
|  | | | |
| Connessione / Connected:  98417402 - 98417403 - 98447620 - 98447621 | | | |
| Eurocargo Eurostar Eurotech | -- | 93161189 | 960088 |
|  | | | |
| Connessione / Connected:  98417402 - 98417403 - 98447620 - 98447621 | | | |

I riferimenti indicati non sono originali ma perfettamente intercambiabili. I codici originali e le case costruttrici sono indicati a puro titolo informativo
 The details described are not original but perfectly interchangeable. The original references and manufacturer names are given for information purposes only.





KIT REVISIONE PINZE FRENO
BRAKE CALIPERS REPAIRING KIT
KIT DE REPARATION POUR ETRIERS DE FREIN
REPARATURSATZ FÜR BREMSSATTEL
РЕМОНТНЫЕ КОМПЛЕКТЫ ДЛЯ СУППОРТОВ
KIT REPARACION PARA PINZAS DE FRENO

| Emmerre | Adattabile a / Adaptable to | Dettagli / Detail | Applicazioni / Applications |
|---|--------------------------------|---|---|
| 960089 | 93161560 | -- | Eurocargo Eurotech Eurostar Eurotrakker |
|  | | | |
| Connessione / Connected: | | |  98417405 - 98417406 |
| 960724 | 42541464 | -- | Eurocargo Cursor Tector Stralisi |
|  | | | |
| 960112 | 42559192 | - Anteriore e posteriore/ <i>Front and rear</i> | Eurocargo |
|  | | | |
| Connessione / Connected: | | |  975121 - 975122 - 975123 - 975126 - 975128 - 975129 - 975130 - 975131 |
| 970752 | 93161552 8124895 8124736 | - Anteriore e posteriore/ <i>Front and rear</i> | Eurocargo |
|  | | | |
| Connessione / Connected: | | |  4830046-4830047-4832624-4832625 |

KIT REVISIONE PINZE FRENO
BRAKE CALIPERS REPAIRING KIT
KIT DE REPARATION POUR ETRIERES DE FREIN
REPARATURSATZ FÜR BREMSSEL
РЕМОНТНЫЕ КОМПЛЕКТЫ ДЛЯ СУППОРТОВ
KIT REPARACION PARA PINZAS DE FRENO

EMMERRE
 spare parts for trucks and trailers

MAN

| Applicazioni / Applications | Dettagli / Detail | Adattabile a / Adaptable to | Emmerre |
|---|---|-----------------------------|---------------|
| Trucks | - Anteriore/Front | 81508226023 | 960708 |
|  | | | |
| Trucks | - Anteriore/Front | 81508226022 81508226007 | 960731 |
|  | | | |
| Trucks | - Anteriore e posteriore/Front and rear | 81508226020 | 960709 |
|  | | | |
| Trucks | - Anteriore e posteriore/Front and rear | 81508226019 | 960710 |
|  | | | |









I riferimenti indicati non sono originali ma perfettamente intercambiabili. I codici originali e le case costruttrici sono indicati a puro titolo informativo
 The details described are not original but perfectly interchangeable. The original references and manufacturer names are given for information purposes only.

| Emmerre | Adattabile a / Adaptable to | Dettagli / Detail | Applicazioni / Applications |
|---|-----------------------------|---|--|
| 960708 | 0004202982 | - Anteriore/Front | Atleon 140 Eco L60 Eco L70 Eco T135 |
|  | | | |
| 960731 | 0004200682 | - Anteriore/Front | Atleon 140 Eco L60 Eco L70 Eco T135 |
|  | | | |
| 960709 | 0004204082 0004202382 | - Anteriore e posteriore/Front and rear | Atleon 140/165 |
|  | | | |







KIT REVISIONE PINZE FRENO
BRAKE CALIPERS REPAIRING KIT
KIT DE REPARATION POUR ETRIER DE FREIN
REPARATURSATZ FÜR BREMSSEL
РЕМОНТНЫЕ КОМПЛЕКТЫ ДЛЯ СУППОРТОВ
KIT REPARACION PARA PINZAS DE FRENO

EMMERRE
 spare parts for trucks and trailers

NISSAN

| Applicazioni / Applications | Dettagli / Detail | Adattabile a / Adaptable to | Emmerre |
|--|--|-----------------------------|---------------|
| Cabstar 45.13/15 | - Anteriore/Front - Esterno/External Ø mm. 52 - Altezza/Height mm. 60,50 | -- | 960714 |
|  | | | |
| Connessione / Connected:  975104 - 975105 | | | |
| NV 400 | - Posteriore/Rear | -- | 960678 |
|  | | | |
| Connessione / Connected:  975360-975361 | | | |
| NV 400 | - Posteriore/Rear | -- | 960679 |
|  | | | |
| Connessione / Connected:  975360-975361 | | | |
| NV 400 | - Posteriore/Rear | -- | 960680 |
|  | | | |
| Connessione / Connected:  975360-975361 | | | |

I riferimenti indicati non sono originali ma perfettamente intercambiabili. I codici originali e le case costruttrici sono indicati a puro titolo informativo
 The details described are not original but perfectly interchangeable. The original references and manufacturer names are given for information purposes only.

| Emmerre | Adattabile a / Adaptable to | Dettagli / Detail | Applicazioni / Applications |
|---|-----------------------------|-------------------|-----------------------------|
| <p>960678</p>  <p>NEWS</p> | -- | - Posteriore/Rear | Movano Combi |
| Connessione / Connected:  | | | 975360-975361 |
| <p>960679</p>  <p>NEWS</p> | -- | - Posteriore/Rear | Movano Combi |
| Connessione / Connected:  | | | 975360-975361 |
| <p>960680</p>  <p>NEWS</p> | -- | - Posteriore/Rear | Movano Combi |
| Connessione / Connected:  | | | 975360-975361 |

KIT REVISIONE PINZE FRENO
BRAKE CALIPERS REPAIRING KIT
KIT DE REPARATION POUR ETRIER DE FREIN
REPARATURSATZ FÜR BREMSSEL
РЕМОНТНЫЕ КОМПЛЕКТЫ ДЛЯ СУППОРТОВ
KIT REPARACION PARA PINZAS DE FRENO

EMMERRE
 spare parts for trucks and trailers

RENAULT

| Applicazioni / Applications | Dettagli / Detail | Adattabile a / Adaptable to | Emmerre |
|--------------------------------------|---|-----------------------------|---------------|
| Master II Mascott 120.55/65/35 | - Posteriore/Rear - Esterno/External Ø mm. 46 - Altezza/Height mm. 59,50 | 42548326 | 960715 |



Connessione / Connected:  975106-975107

| | | | |
|--------|--|--------------------------|---------------|
| Trucks | - Kit revisione pinza/ <i>Brake caliper repairing kit</i> | 5001014701 5001829895 | 960752 |
|--------|--|--------------------------|---------------|



| | | | |
|------------|--------------------------|----|---------------|
| Master III | - Posteriore/Rear | -- | 960678 |
|------------|--------------------------|----|---------------|



Connessione / Connected:  975360-975361

| | | | |
|------------|--------------------------|----|---------------|
| Master III | - Posteriore/Rear | -- | 960679 |
|------------|--------------------------|----|---------------|



Connessione / Connected:  975360-975361

I riferimenti indicati non sono originali ma perfettamente intercambiabili. I codici originali e le case costruttrici sono indicati a puro titolo informativo
 The details described are not original but perfectly interchangeable. The original references and manufacturer names are given for information purposes only.

Emmerre

Adattabile a / *Adaptable to*

Dettagli / *Detail*

Applicazioni / *Applications*

960680

--

- *Posteriore/Rear*

Master III



Connessione / *Connected:*







975360-975361





KIT REVISIONE PINZE FRENO
BRAKE CALIPERS REPAIRING KIT
KIT DE REPARATION POUR ETRIERES DE FREIN
REPARATURSATZ FÜR BREMSSEL
РЕМОНТНЫЕ КОМПЛЕКТЫ ДЛЯ СУППОРТОВ
KIT REPARACION PARA PINZAS DE FRENO

EMMERRE
 spare parts for trucks and trailers

ROR

| Applicazioni / Applications | Dettagli / Detail | Adattabile a / Adaptable to | Emmerre |
|--|-------------------|-----------------------------|---------------|
| Axle | - Posteriore/Rear | SJ1033 | 960083 |
|  | | | |
| Axle | - Posteriore/Rear | SJ1030 | 960728 |
|  | | | |
| Axle | - Posteriore/Rear | SJ1034 | 960730 |
|  | | | |
| Axle | | SJ4109 | 960400 |
|  | | | |

I riferimenti indicati non sono originali ma perfettamente intercambiabili. I codici originali e le case costruttrici sono indicati a puro titolo informativo
 The details described are not original but perfectly interchangeable. The original references and manufacturer names are given for information purposes only.

| Emmerre | Adattabile a / Adaptable to | Dettagli / Detail | Applicazioni / Applications |
|--|-----------------------------|-------------------|-----------------------------|
| 960257 | SJ4098 | - Anteriore/Front | Axle |
|  | | | |
| Connessione / Connected:  B/C/D - Duco - Series LRG | | | |
| 960157 | SJ4112 | - Posteriore/Rear | Axle |
|  | | | |
| Connessione / Connected:  Elsa 1 - Series LRG | | | |
| 960267 | MEK1238 | | Axle |
|  | | | |
| Connessione / Connected:  B/C/D - DUCO | | | |
| 960266 | MEK1118 | - Anteriore/Front | Axle |
|  | | | |
| Connessione / Connected:  B/C/D - Duco | | | |

KIT REVISIONE PINZE FRENO
BRAKE CALIPERS REPAIRING KIT
KIT DE REPARATION POUR ETRIERES DE FREIN
REPARATURSATZ FÜR BREMSSEL
РЕМОНТНЫЕ КОМПЛЕКТЫ ДЛЯ СУППОРТОВ
KIT REPARACION PARA PINZAS DE FRENO

EMMERRE
 spare parts for trucks and trailers

ROR

| Applicazioni / Applications | Dettagli / Detail | Adattabile a / Adaptable to | Emmerre |
|-----------------------------|-------------------|-----------------------------|---------------|
| Axle | -- | MEK1116 | 960265 |



| Connessione / Connected: | B/C/D - Duco |
|---|--------------|
|  | |

| | | | |
|------|---|---------|---------------|
| Axle | - Posteriore/Rear - Destra/Right | MEK1237 | 960263 |
|------|---|---------|---------------|



| Connessione / Connected: | B/C/D - Duco |
|---|--------------|
|  | |

| | | | |
|------|--|---------|---------------|
| Axle | - Posteriore/Rear - Sinistra/Left | MEK1236 | 960262 |
|------|--|---------|---------------|





| Connessione / Connected: | B/C/D - Duco |
|---|--------------|
|  | |

| | | | |
|------|--|--------|---------------|
| Axle | - Destra/Right - Con registro/With adjuster | SJ4114 | 960277 |
|------|--|--------|---------------|



I riferimenti indicati non sono originali ma perfettamente intercambiabili. I codici originali e le case costruttrici sono indicati a puro titolo informativo
 The details described are not original but perfectly interchangeable. The original references and manufacturer names are given for information purposes only.

| Emmerre | Adattabile a / <i>Adaptable to</i> | Dettagli / <i>Detail</i> | Applicazioni / <i>Applications</i> |
|--|------------------------------------|---|---|
| <p>960264</p>  | <p>MEK1129</p> | <p>- Kit revisione molle registro pinze freno/ <i>Brake caliper adjusting springs repair kit</i></p> | <p>Axle</p> <p>Connessione / <i>Connected:</i>  B/C/D - Duco</p> |

KIT REVISIONE PINZE FRENO
BRAKE CALIPERS REPAIRING KIT
KIT DE REPARATION POUR ETRIERES DE FREIN
REPARATURSATZ FÜR BREMSSATTEL
РЕМОНТНЫЕ КОМПЛЕКТЫ ДЛЯ СУППОРТОВ
KIT REPARACION PARA PINZAS DE FRENO

EMMERRE
 spare parts for trucks and trailers

SCANIA

| Applicazioni / Applications | Dettagli / Detail | Adattabile a / Adaptable to | Emmerre |
|-----------------------------|-------------------|-------------------------------|---------------|
| Serie 4 Serie P/G/R/T | - Anteriore/Front | 1759811 1746824 1390429 | 960731 |



KIT REVISIONE PINZE FRENO BRAKE CALIPERS REPAIRING KIT KIT DE REPARATION POUR ETRIERES DE FREIN REPARATURSATZ FÜR BREMSSATTEL РЕМОНТНЫЕ КОМПЛЕКТЫ ДЛЯ СУППОРТОВ KIT REPARACION PARA PINZAS DE FRENO

| Emmerre | Adattabile a / Adaptable to | Dettagli / Detail | Applicazioni / Applications |
|---|--------------------------------|--|-----------------------------|
| 960266  | 85102092 3096768 3092256 | - Anteriore/ <i>Front</i> | FH FM |
| Connessione / Connected:  B/C/D - Duco | | | |
| 960265  | 85102094 | - Posteriore/ <i>Rear</i> | FH FM |
| Connessione / Connected:  B/C/D - Duco | | | |
| 960263  | 3092263 | - Posteriore/ <i>Rear</i> - Destra/ <i>Right</i> | FH FM |
| Connessione / Connected:  B/C/D - Duco | | | |
| 960262  | 3092262 | - Posteriore/ <i>Rear</i> - Sinistra/ <i>Left</i> | FH FM |
| Connessione / Connected:  B/C/D - Duco | | | |

KIT REVISIONE PINZE FRENO
BRAKE CALIPERS REPAIRING KIT
KIT DE REPARATION POUR ETRIERES DE FREIN
REPARATURSATZ FÜR BREMSSEL
РЕМОНТНЫЕ КОМПЛЕКТЫ ДЛЯ СУППОРТОВ
KIT REPARACION PARA PINZAS DE FRENO

EMMERRE
 spare parts for trucks and trailers

VOLVO

| Applicazioni / Applications | Dettagli / Detail | Adattabile a / Adaptable to | Emmerre |
|-----------------------------|--------------------------------------|-----------------------------|---------------|
| FH FM | - Anteriore/Front - Sinistra/Left | 3092267 | 960261 |



| Connessione / Connected:  B/C/D - Duco | | | |
|---|-------------------------------------|----------|---------------|
| FH FM | - Anteriore/Front - Destra/Right | 85102093 | 960260 |



| Connessione / Connected:  B/C/D - Duco | | | |
|---|-------------------------------------|----------|---------------|
| FH FM | - Posteriore/Rear - Destra/Right | 85102096 | 960259 |



| Connessione / Connected:  B/C/D - Duco | | | |
|---|--------------------------------------|----------|---------------|
| FH FM | - Posteriore/Rear - Sinistra/Left | 85102095 | 960258 |



| Connessione / Connected:  B/C/D - Duco | | | |
|---|--|--|--|
|---|--|--|--|



I riferimenti indicati non sono originali ma perfettamente intercambiabili. I codici originali e le case costruttrici sono indicati a puro titolo informativo
 The details described are not original but perfectly interchangeable. The original references and manufacturer names are given for information purposes only.

EMMERRE

spare parts for trucks and trailers

VOLVO



KIT REVISIONE PINZE FRENO BRAKE CALIPERS REPAIRING KIT KIT DE REPARATION POUR ETRIERES DE FREIN REPARATURSATZ FÜR BREMSSATTEL РЕМОНТНЫЕ КОМПЛЕКТЫ ДЛЯ СУППОРТОВ KIT REPARACION PARA PINZAS DE FRENO

| Emmerre | Adattabile a / Adaptable to | Dettagli / Detail | Applicazioni / Applications |
|--|-----------------------------|---|-----------------------------|
| 960257  | 3092261 | - Anteriore/Front | FH FM |
| Connessione / Connected:  B/C/D - Duco - Series LRG | | | |
| 960157  | 3092329 | - Posteriore/Rear | FH FM |
| Connessione / Connected:  Elsa 1 - Series LRG | | | |
| 960267  | 3092264 | - Posteriore/Rear - Sinistra/Left | FH FM |
| Connessione / Connected:  B/C/D - Duco | | | |
| 960264  | 3095626 | - Kit revisione molle registro pinze freno/ Brake caliper adjusting springs repair kit | FH FM |
| Connessione / Connected:  B/C/D - Duco | | | |

KIT REVISIONE PINZE FRENO
BRAKE CALIPERS REPAIRING KIT
KIT DE REPARATION POUR ETRIERES DE FREIN
REPARATURSATZ FÜR BREMSSEL
РЕМОНТНЫЕ КОМПЛЕКТЫ ДЛЯ СУППОРТОВ
KIT REPARACION PARA PINZAS DE FRENO

EMMERRE
 spare parts for trucks and trailers

VOLVO

| Applicazioni / Applications | Dettagli / Detail | Adattabile a / Adaptable to | Emmerre |
|--|---|--|---------------|
| B 12 FH 12 FH 16 FM 7 FM 10 FM 12 | | 3092270 | 960400 |
| | |  | |
| Trucks LRG728/729 | - Kit Revisione pinza/ Brake caliper repairing kit | 85109890 | 961063 |
| | |  | |
| Trucks | - Kit Revisione pinza/ Brake caliper repairing kit | 3090937 270527 | 960752 |
| | |  | |

| Emmerre | Adattabile a / Adaptable to | Dettagli / Detail | Applicazioni / Applications |
|--|-----------------------------|--|--|
| 960288  | -- | - Con registro/ <i>With adjuster</i> | Daf Pan19-1 Plus Saf Wabco |
| 960289  | -- | | Daf Pan19-1 Plus Saf Wabco |
| 960290  | -- | - Con molla/ <i>With spring</i> - Con albero/ <i>With shaft</i> | Pan 17-19 Wabco |
| 960291  | -- | - Nuovo tipo/ <i>New type</i> | Lucas Man Mercedes Meritor Renault |



KIT REVISIONE PINZE FRENO
BRAKE CALIPERS REPAIRING KIT
KIT DE REPARATION POUR ETRIER DE FREIN
REPARATURSATZ FÜR BREMSSEL
РЕМОНТНЫЕ КОМПЛЕКТЫ ДЛЯ СУППОРТОВ
KIT REPARACION PARA PINZAS DE FRENO

EMMERRE
 spare parts for trucks and trailers

VARIOUS

| Applicazioni / Applications | Dettagli / Detail | Adattabile a / Adaptable to | Emmerre |
|---|--|-----------------------------|---|
| Irisbus Lucas Renault Volvo Bus | - Con registro/With adjuster - Destra/Right | -- | 960277 |
| | | |  |
| Knorr SB/SN-6/7 all types | - Albero con molla pinze freno/Brake caliper spring shaft | -- | 960280 |
| | | |  |
| Connessione / Connected:  SN5/6/7 - SB6/7 - SK | | | |
| Knorr SB/SN -6/7 all types | - Albero con molla pinze freno/Brake caliper spring shaft | -- | 960281 |
| | | |  |
| Connessione / Connected:  SN5/6/7 - SB6/7 - SK | | | |
| Knorr SB/SN -5 | | -- | 960282 |
| | | |  |
| Connessione / Connected:  SN5/6/7 - SB6/7 - SK | | | |







I riferimenti indicati non sono originali ma perfettamente intercambiabili. I codici originali e le case costruttrici sono indicati a puro titolo informativo
 The details described are not original but perfectly interchangeable. The original references and manufacturer names are given for information purposes only.

| Emmerre | Adattabile a / Adaptable to | Dettagli / Detail | Applicazioni / Applications |
|--|-----------------------------|--|--|
| 960283 | -- | - Corpo per albero con cuscinetto nuovo modello/ <i>Brake caliper bearing shaft body new model</i> | Knorr SB/SN -6/7 |
| Connessione / Connected:  | | | SN5/6/7 - SB6/7 - SK |
| 960294 | -- | - Ingranaggio destro pinze freno/ <i>Brake caliper gear right</i> | Irisbus Lucas Man Mercedes Meritor Renault |
| Connessione / Connected:  | | | Elsa 1 |
| 960295 | -- | - Ingranaggio sinistro pinze freno/ <i>Brake caliper gear left</i> | Irisbus Lucas Man Mercedes Meritor Renault |
| Connessione / Connected:  | | | Elsa 1 |
| 960279 | -- | - Ingranaggio grande destro pinze freno/ <i>Brake caliper big gear right</i> | Irisbus Lucas Man Mercedes Meritor Renault Volvo Bus |
| Connessione / Connected:  | | | MPO D3 |

KIT REVISIONE PINZE FRENO
BRAKE CALIPERS REPAIRING KIT
KIT DE REPARATION POUR ETRIERS DE FREIN
REPARATURSATZ FÜR BREMSSEL
РЕМОНТНЫЕ КОМПЛЕКТЫ ДЛЯ СУППОРТОВ
KIT REPARACION PARA PINZAS DE FRENO

EMMERRE
 spare parts for trucks and trailers

VARIOUS

| Applicazioni / Applications | Dettagli / Detail | Adattabile a / Adaptable to | Emmerre |
|--|--|-----------------------------|---------------|
| Man Meritor Renault Ror | - Albero ingranaggio piccolo pinze freno/Brake caliper shaft small gear | -- | 960273 |
|  | | | |
| Connesione / Connected:  Elsa 2/195/225 | | | |
| Man Meritor Renault Ror | - Boccia albero calibrata pinze freno/Brake caliper calibration shaft | -- | 960269 |
|  | | | |
| Connesione / Connected:  Elsa 1 | | | |
| Knorr SN -6/7 Scania SB6/7 SK | - Corpo per albero con cuscinetto/ Brake caliper bearings body - Vecchio modello/Old model | -- | 960302 |
|  | | | |
| Knorr SN -6/7 Scania SB6/7 SK | - Corpo per albero con cuscinetto/ Brake caliper bearings body - Nuovo modello/New model | -- | 960340 |
|  | | | |
| Connesione / Connected:  Elsa 1 | | | |

I riferimenti indicati non sono originali ma perfettamente intercambiabili. I codici originali e le case costruttrici sono indicati a puro titolo informativo
 The details described are not original but perfectly interchangeable. The original references and manufacturer names are given for information purposes only.

| Emmerre | Adattabile a / Adaptable to | Dettagli / Detail | Applicazioni / Applications |
|---------------|-----------------------------|---|---|
| 960416 | -- | - Guarnizione pinza freno/ <i>Brake caliper ring</i> | Irisbus Lucas Man Mercedes Meritor |
| | | | Connessione / Connected:  Elsa 1 |
| 960420 | -- | - Piastra pinze freno/ <i>Brake caliper plates</i> | Lucas Man Mercedes Meritor |
| | | | Connessione / Connected:  D3 |
| 960296 | -- | - Ingranaggio piccolo pinze freno/ <i>Brake caliper gear small</i> - Destra/ <i>Right</i> | Lucas Meritor Renault |
| 960297 | -- | - Ingranaggio piccolo pinze freno/ <i>Brake caliper gear small</i> - Sinistra/ <i>Left</i> | Lucas Meritor Renault |



MASSE FRENO

BRAKE ASSEMBLY
FLASQUES DE FREIN
RADBREMSEN
ТОРОЗНАЯ ГРУППА
MASAS DE FRENO

BRAKE PARTS MANUFACTURER
TECHNO
BRAKE СЪВЕРШЕ













NEWS

| Emmerre | Descrizione/Description | Adattabile/Adaptable to | Pagina/Page |
|---------------|--|-------------------------|-------------|
| 960586 | GANASCIA FRENO NUDA / BRAKE SHOE NAKED | ROR | 652 |
| 960587 | GANASCIA FRENO NUDA / BRAKE SHOE NAKED | ROR | 652 |
| 963630 | KIT RIPARAZIONE FRENO / BRAKE REPAIRING KIT | IVECO | 686 |
| 960590 | REGISTRO FRENO A TAMBURO / BRAKE DRUM ADJUSTER | IVECO | 689 |
| 960591 | REGISTRO FRENO A TAMBURO / BRAKE DRUM ADJUSTER | RENAULT | 705 |
| 963632 | KIT REVISIONE Z-CAM COMPLETO / COMPLETE Z-CAM REVISION KIT | VOLVO | 735 |
| 963633 | KIT REVISIONE Z-CAM COMPLETO / COMPLETE Z-CAM REVISION KIT | VOLVO | 735 |
| 964000 | POMPA FRENO / BRAKE PUMP | IVECO | 745 |
| 972096 | TUBO FLESSIBILE FRENO / PNEUMATIC BRAKE PIPE | IVECO | 749 |
| 972103 | TUBO FRENO / BRAKE PIPE | IVECO | 751 |
| 964058 | SERBATOIO LIQUIDO FRENI / BRAKE FLUID TANK | IVECO | 752 |

**MASSE FRENO
BRAKE ASSEMBLY
FLASQUES DE FREIN
RADBREMSEN
ТОРОЗНАЯ ГРУППА
MASAS DE FRENO**

EMMERRE
spare parts for trucks and trailers

IVECO

| Applicazioni / Applications | Dettagli / Detail | Adattabile a / Adaptable to | Emmerre |
|--|--|-----------------------------|--|
| Daily Restyling New Daily | - Sinistra/Left - Esterno/External Ø mm.: 254 - Interno/Internal Ø mm.: 89 <u>Lockheed system</u> | 500300073 7165370 | 963086  |
| Connessione / Connected:  964201  961009 | | | |
| Daily Restyling New Daily | - Destra/Right - Esterno/External Ø mm.: 254 - Interno/Internal Ø mm.: 89 <u>Lockheed system</u> | 500300075 7165371 | 963087  |
| Connessione / Connected:  964201  961009 | | | |
| New Daily Turbodaily | - Sinistra/Left - Con indicatore usura freno/ With wear brake indicator - Esterno/External Ø mm.: 254 - Interno/Internal Ø mm.: 89 <u>Lockheed system</u> | 500300079 | 963098  |
| Connessione / Connected:  964201  961011 | | | |
| New Daily Turbodaily | - Destra/Right - Con indicatore usura freno/ With wear brake indicator - Esterno/External Ø mm.: 254 - Interno/Internal Ø mm.: 89 <u>Lockheed system</u> | 500300080 | 963097  |
| Connessione / Connected:  964201  961011 | | | |

I riferimenti indicati non sono originali ma perfettamente intercambiabili. I codici originali e le case costruttrici sono indicati a puro titolo informativo
The details described are not original but perfectly interchangeable. The original references and manufacturer names are given for information purposes only.











627

EMMERRE

spare parts for trucks and trailers

IVECO

















MASSE FRENO
BRAKE ASSEMBLY
FLASQUES DE FREIN
RADBREMSEN
ТОРОЗНАЯ ГРУППА
MASAS DE FRENO

| Emmerre | Adattabile a / Adaptable to | Dettagli / Detail | Applicazioni / Applications |
|--|------------------------------------|--|--|
| 963114  | 500300092 500300082 | - Sinistra/Left - Con indicatore usura freno/ With wear brake indicator - Esterno/External Ø mm.: 254 - Interno/Internal Ø mm.: 89 <i>Lockheed system</i> | New Daily Turbodaily |
| | | Connessione / Connected:  964203 |  961011 |
| 963115  | 500300093 500300083 | - Destra/Right - Con indicatore usura freno/ With wear brake indicator - Esterno/External Ø mm.: 254 - Interno/Internal Ø mm.: 89 <i>Lockheed system</i> | New Daily Turbodaily |
| | | Connessione / Connected:  964203 |  961011 |
| 970103  | 504102693 504060927 99431433 | - Complessivo freno a mano post./ Complete rear hand brake assembly - Destra/Right | Daily City 2000 New Daily '96 Turbodaily '96 |
| | | Connessione / Connected:  970101 | |
| 970104  | 504102692 504060926 99431432 | - Complessivo freno a mano post./ Complete rear hand brake assembly - Sinistra/Left | Daily City 2000 New Daily '96 Turbodaily '96 |
| | | Connessione / Connected:  970101 | |























**MASSE FRENO
BRAKE ASSEMBLY
FLASQUES DE FREIN
RADBREMSEN
ТОРОЗНАЯ ГРУППА
MASAS DE FRENO**

EMMERRE
spare parts for trucks and trailers

IVECO

| Applicazioni / Applications | Dettagli / Detail | Adattabile a / Adaptable to | Emmerre |
|--|--|-----------------------------|--|
| Daily MY 2006 | - Complessivo freno a mano post./ <i>Complete rear hand brake assembly</i> - Destra/Right | 5801324148 504093277 | 970132  |
| Connessione / Connected:  970102 | | | |
| Daily MY 2006 | - Complessivo freno a mano post./ <i>Complete rear hand brake assembly</i> - Sinistra/Left | 5801324147 504093276 | 970131  |
| Connessione / Connected:  970102 | | | |
| Turbostar Turbotech | - Sinistra/Left - Massa freno posteriore completa/ <i>Complete rear assembly</i> - Esterno/External Ø mm.: 381 - Interno/Internal Ø mm.: 180 <i>Rockwell system</i> | 42101963 42101841 | 963069  |
| Connessione / Connected:  963106  963001 | | | |
| Connessione / Connected:  961013-960559-960560  961055  AS5011 | | | |
| Turbostar Turbotech | - Destra/Right - Massa freno posteriore completa/ <i>Complete rear assembly</i> - Esterno/External Ø mm.: 381 - Interno/Internal Ø mm.: 180 <i>Rockwell system</i> | 42101964 42101842 | 963068  |
| Connessione / Connected:  963106  963001 | | | |
| Connessione / Connected:  961013-960559-960560  961055  AS5011 | | | |

I riferimenti indicati non sono originali ma perfettamente intercambiabili. I codici originali e le case costruttrici sono indicati a puro titolo informativo
The details described are not original but perfectly interchangeable. The original references and manufacturer names are given for information purposes only.

| Emmerre | Adattabile a / Adaptable to | Dettagli / Detail | Applicazioni / Applications |
|--|---|---|---|
| 963457  | 41032928 41022771 | - Sinistra/Left - Simplex - Massa freno anteriore completa/ <i>Complete front assembly</i> - Esterno/External Ø mm.: 410 - Interno/Internal Ø mm.: 180 <i>Rockwell system</i> | Eurotech Eurotech Cursor Eurotrakker Eurostar Eurostar Cursor Stralis |
| | Connessione / Connected:  963529  963523-963524  963532  963533 | | |
| 963456  | 41032929 41022772 | - Destra/Right - Simplex - Massa freno anteriore completa/ <i>Complete front assembly</i> - Esterno/External Ø mm.: 410 - Interno/Internal Ø mm.: 180 <i>Rockwell system</i> | Eurotech Eurotech Cursor Eurotrakker Eurostar Eurostar Cursor Stralis |
| | Connessione / Connected:  963529  963523-963524  AS5026  963532  963533 | | |
| 963551  | 41022773 | - Sinistra/Left - Simplex - Massa freno posteriore completa/ <i>Complete rear assembly</i> - Esterno/External Ø mm.: 410 - Interno/Internal Ø mm.: 200 <i>Rockwell system</i> | Eurotech Eurotech Cursor Eurotrakker Eurostar Eurostar Cursor Stralis |
| | Connessione / Connected:  963531  963520-963521  AS5010  963532  963533 | | |
| 963552  | 41022774 | - Destra/Right - Simplex - Massa freno posteriore completa/ <i>Complete rear assembly</i> - Esterno/External Ø mm.: 410 - Interno/Internal Ø mm.: 200 <i>Rockwell system</i> | Eurotech Eurotech Cursor Eurotrakker Eurostar Eurostar Cursor Stralis |
| | Connessione / Connected:  963531  963520-963521  AS5010  963532  963533 | | |













**MASSE FRENO
BRAKE ASSEMBLY
FLASQUES DE FREIN
RADBREMSEN
ТОРОЗНАЯ ГРУППА
MASAS DE FRENO**

EMMERRE
spare parts for trucks and trailers

IVECO

| Applicazioni / Applications | Dettagli / Detail | Adattabile a / Adaptable to | Emmerre |
|---|---|-----------------------------|--|
| Eurotech Eurotech Cursor Eurostar Eurotraker Eurotrakker Cursor Stralis | - Sinistra/Left - Massa freno anteriore completa/ Complete front assembly - Esterno/External Ø mm.: 410 - Interno/Internal Ø mm.: 180 <u>Perrot system</u> VERSIONE O.E. | 41025287 10410837 | 963902  |
| Connessione / Connected:  963615  963528  AS5031 | | | |
| Eurotech Eurotech Cursor Eurostar Eurotraker Eurotrakker Cursor Stralis | - Destra/Right - Massa freno anteriore completa/ Complete front assembly - Esterno/External Ø mm.: 410 - Interno/Internal Ø mm.: 180 <u>Perrot system</u> VERSIONE O.E. | 41025288 10410838 | 963903  |
| Connessione / Connected:  963615  963528  AS5031 | | | |
| Eurotech Eurotech Cursor Eurostar Eurostar Cursor Eurotrakker Eurotrakker Cursor Stralis | - Sinistra/Left - Massa freno posteriore completa/ Complete rear assembly - Esterno/External Ø mm.: 410 - Interno/Internal Ø mm.: 200 <u>Perrot system</u> VERSIONE O.E. | 41025289 10410839 | 963557  |
| Connessione / Connected:  963559  963522  AS5024 | | | |
| Eurotech Eurotech Cursor Eurostar Eurostar Cursor Eurotrakker Eurotrakker Cursor Stralis | - Destra/Right - Massa freno posteriore completa/ Complete rear assembly - Esterno/External Ø mm.: 410 - Interno/Internal Ø mm.: 200 <u>Perrot system</u> VERSIONE O.E. | 41025290 10410840 | 963558  |
| Connessione / Connected:  963559  963522  AS5024 | | | |













I riferimenti indicati non sono originali ma perfettamente intercambiabili. I codici originali e le case costruttrici sono indicati a puro titolo informativo
The details described are not original but perfectly interchangeable. The original references and manufacturer names are given for information purposes only.

| Emmerre | Adattabile a / Adaptable to | Dettagli / Detail | Applicazioni / Applications |
|---|-----------------------------|---|---|
| 963570  | 41211321 41211043 | - Sinistra/Left - Duplex - Massa freno posteriore completa/ <i>Complete rear assembly</i> - Esterno/External Ø mm.: 410 - Interno/Internal Ø mm.: 200 <i>Meritor system</i> VERSIONE O.E. | Eurotrakker Eurotrakker Cursor Stralis |
| Connessione / Connected:  963591-963128-963129  963499  AS5029  963131 | | | |
| 963571  | 41211322 41211044 | - Destra/Right - Duplex - Massa freno posteriore completa/ <i>Complete rear assembly</i> - Esterno/External Ø mm.: 410 - Interno/Internal Ø mm.: 200 <i>Meritor system</i> VERSIONE O.E. | Eurotrakker Eurotrakker Cursor Stralis |
| Connessione / Connected:  963591-963128-963129  963499  AS5029  963131 | | | |
| 963110  | 4815279 | - Sinistra/Left - Massa freno posteriore completa/ <i>Complete rear assembly</i> - Esterno/External Ø mm.: 325 - Interno/Internal Ø mm.: 100 - Spessore/Thickness mm.: 12 | -- |
| 963111  | 4815280 | - Destra/Right - Massa freno posteriore completa/ <i>Complete rear assembly</i> - Esterno/External Ø mm.: 325 - Interno/Internal Ø mm.: 100 - Spessore/Thickness mm.: 12 | -- |

**MASSE FRENO
BRAKE ASSEMBLY
FLASQUES DE FREIN
RADBREMSEN
ТОРОЗНАЯ ГРУППА
MASAS DE FRENO**

EMMERRE
spare parts for trucks and trailers

ROR

| Applicazioni / Applications | Dettagli / Detail | Adattabile a / Adaptable to | Emmerre |
|--|---|-----------------------------|---------------|
| Axle | <ul style="list-style-type: none"> - Sinistra/Left - Assale posteriore/Rear axle - Massa freno completa/Complete assembly - Esterno/External Ø mm.: 381 - Interno/Internal Ø mm.: 180 <p><i>Rockwell system</i></p> | RD15705153 | 963069 |
| Connessione / Connected:  961013  961055  AS5011 | | | |
| Axle | <ul style="list-style-type: none"> - Destra/Right - Assale posteriore/Rear axle - Massa freno completa/Complete assembly - Esterno/External Ø mm.: 381 - Interno/Internal Ø mm.: 180 <p><i>Rockwell system</i></p> | RD15705154 | 963068 |
| Connessione / Connected:  961013  963062  AS5011 | | | |
| Axle | <ul style="list-style-type: none"> - Sinistra/Left - Simplex - Assale posteriore/Rear axle - Massa freno completa/Complete assembly - Esterno/External Ø mm.: 410 - Interno/Internal Ø mm.: 180 <p><i>Rockwell system</i></p> | RS41018205 RS41018221 | 963457 |
| Connessione / Connected:  963529  963523-963524  AS5026 | | | |
| Axle | <ul style="list-style-type: none"> - Destra/Right - Simplex - Assale posteriore/Rear axle - Massa freno completa/Complete assembly - Esterno/External Ø mm.: 410 - Interno/Internal Ø mm.: 180 <p><i>Rockwell system</i></p> | RS41018206 RS41018222 | 963456 |
| Connessione / Connected:  963529  963523-963524  AS5026 | | | |

I riferimenti indicati non sono originali ma perfettamente intercambiabili. I codici originali e le case costruttrici sono indicati a puro titolo informativo
The details described are not original but perfectly interchangeable. The original references and manufacturer names are given for information purposes only.

| Emmerre | Adattabile a / Adaptable to | Dettagli / Detail | Applicazioni / Applications |
|---------------|-----------------------------|--|---|
| 963650 | 0509146360 | - Ganaschia nuda/ <i>Naked brake shoe</i> - Ø mm. 360 x 200 | Axle |
| | | | Connessione / Connected:  AS5052 |
| 963651 | 0509114800 | - Ganaschia nuda/ <i>Naked brake shoe</i> - Ø mm. 300 x 200 | Axle |
| | | | Connessione / Connected:  AC1653 |

**GANASCE FRENO
BRAKE SHOES
MACHOIRES DE FREIN
BREMSBACKEN
БАРАБАНЫЕ КОЛОДКИ
MORDAZAS DE FRENO**

EMMERRE
spare parts for trucks and trailers

FIAT

| Applicazioni / Applications | Dettagli / Detail | Adattabile a / Adaptable to | Emmerre |
|--|--|---|---------------|
| Ducato Citroen Jumper Peugeot Boxer | - Serie ganasce complete/ <i>Set complete brake shoes</i> - Posteriore/Rear - Ø mm. 254 x 57 <u>Girling system</u> | 9945885 4241H4 | 961012 |
| Ducato Citroen Jumper Peugeot Boxer | - Serie ganasce complete/ <i>Set complete brake shoes</i> - Posteriore/Rear - Ø mm. 254 x 87 <u>Girling system</u> | 9467549388 9945884 77362428 4241H5 | 961000 |
| Ducato Scudo Ulisse Citroen Jumpy Peugeot Expert | - Serie ganasce complete/ <i>Set complete brake shoes</i> - Posteriore/Rear - Ø mm. 255 x 60 <u>Bendix system</u> | 77362451 9569692680 9566949580 4241H7 4241K6 | 961057 |
| Ducato 2006 Citroen Jumpy Peugeot Boxer | - Serie ganasce complete/ <i>Set complete brake shoes</i> - Posteriore/Rear - Ø mm. 172 x 42 <u>Bendix system</u> | 77363479 9949494 77363478 77362290 77362699 4241L1 4241L9 | 961050 |







| Emmerre | Adattabile a / <i>Adaptable to</i> | Dettagli / <i>Detail</i> | Applicazioni / <i>Applications</i> |
|--|--|---|------------------------------------|
| <p>961062</p>  | <p>4525732 4055724 4143208 1227046 4455986</p> | <p>- Serie ganasce complete/ <i>Set complete brake shoes</i> - Posteriore/<i>Rear</i> - Ø mm. 280 x 65</p> <p><u><i>Bosch system</i></u></p> | <p>Transit</p> |
| | | | |
| | | | |
| | | | |

**GANASCE FRENO
BRAKE SHOES
MACHOIRES DE FREIN
BREMSBACKEN
БАРАБАННЫЕ КОЛОДКИ
MORDAZAS DE FRENO**

EMMERRE
spare parts for trucks and trailers

IVECO

| Applicazioni / Applications | Dettagli / Detail | Adattabile a / Adaptable to | Emmerre |
|--|--|-----------------------------|---------------|
| Daily Restyling New Daily Turbodaily | <ul style="list-style-type: none"> - Serie ganasce complete/ <i>Set complete brake shoes</i> - Senza indicatore usura freno/ <i>Without wear brake indicator</i> - Posteriore/Rear - Ø mm. 254 x 89 <p>Omologazione/Homologation Nr.: E11 90R-02B01109/41467</p> | 1906350 | 961009 |
|  | | | |
| Connessione / Connected: 963086-963087 | | | |
| Daily Restyling New Daily Turbodaily | <ul style="list-style-type: none"> - Serie ganasce complete/ <i>Set complete brake shoes</i> - Aumentato/Increased 10/10 - Posteriore/Rear - Ø mm. 254 x 89 | -- | 961042 |
|  | | | |
| New Daily Turbodaily | <ul style="list-style-type: none"> - Serie ganasce complete/ <i>Set complete brake shoes</i> - Con indicatore usura freno/ <i>With wear brake indicator</i> - Posteriore/Rear - Ø mm. 254 x 89 | 1906351 | 961011 |
|  | | | |
| Connessione / Connected:  963114-963115-963097-963098 | | | |
| Daily Restyling New Daily Turbodaily (Singolo/Single wheel) | <ul style="list-style-type: none"> - Serie ganasce complete/ <i>Set complete brake shoes</i> - Senza indicatore usura freno/ <i>Without wear brake indicator</i> - Posteriore/Rear - Ø mm. 254 x 70 | 1906352 | 961018 |
|  | | | |

I riferimenti indicati non sono originali ma perfettamente intercambiabili. I codici originali e le case costruttrici sono indicati a puro titolo informativo
The details described are not original but perfectly interchangeable. The original references and manufacturer names are given for information purposes only.

637

EMMERRE

spare parts for trucks and trailers

IVECO

GANASCE FRENO
BRAKE SHOES
MACHOIRES DE FREIN
BREMSBACKEN
БАРАБАНЫЕ КОЛОДКИ
MORDAZAS DE FRENO

| Emmerre | Adattabile a / Adaptable to | Dettagli / Detail | Applicazioni / Applications |
|--|-----------------------------|--|--|
| 961040  | 1906377 | - Serie ganasce complete/ <i>Set complete brake shoes</i> - Posteriore/Rear - Ø mm. 260 x 80 <i>Perrot System</i> | Daily Restyling New Daily Turbodaily |
| 961037  | 1906073 | - Serie ganasce complete/ <i>Set complete brake shoes</i> - Posteriore/Rear - Ø mm. 325 x 100 <i>Sirmac System</i> | Daily Turbozeta 65.9 Zeta |
| 961010  | 1906403 | - Serie ganasce complete/ <i>Set complete brake shoes</i> - Per freno a mano/ <i>For hand brake</i> - Posteriore/Rear - Ø mm. 172 x 42 <i>Brembo System</i> Omologazione/Homologation Nr.: E11 90R-02B01108/41468 | Daily City 2000 New Daily '96 Turbodaily '96 |
| 970101  | 2992568 | - Serie ganasce complete/ <i>Set complete brake shoes</i> - Per freno a mano/ <i>For hand brake</i> - Posteriore/Rear - Ø mm. 172 x 42 <i>Brembo System</i> Omologazione/Homologation Nr.: E11 90R-02B01108/41468 | Daily City 2000 New Daily '96 Turbodaily '96 |

Connessione / Connected:



AS5027

**GANASCE FRENO
BRAKE SHOES
MACHOIRES DE FREIN
BREMSBACKEN
БАРАБАННЫЕ КОЛОДКИ
MORDAZAS DE FRENO**

EMMERRE
spare parts for trucks and trailers

IVECO

| Applicazioni / Applications | Dettagli / Detail | Adattabile a / Adaptable to | Emmerre |
|---|---|-----------------------------|---------------|
| Daily M.Y. 2006 | <ul style="list-style-type: none"> - Serie ganasce complete/ <i>Set complete brake shoes</i> - Per freno a mano/<i>For hand brake</i> - Posteriore/<i>Rear</i> - Ø mm. 172 x 42 <p><i>Brembo System</i> <u>Omologazione/Homologation Nr.:</u> <u>E11 90R-02B01108/41470</u></p> | 2995817 500054631 | 970120 |
|  | | | |
| Connessione / Connected: 970103-970104 | | | |
| Daily City 2000 | <ul style="list-style-type: none"> - Serie ganasce complete/ <i>Set complete brake shoes</i> - Per freno a mano/<i>For hand brake</i> - Posteriore/<i>Rear</i> - Ø mm. 190 x 42 <p><i>Brembo System</i> <u>Omologazione/Homologation Nr.:</u> <u>E11 90R-02B01108/41469</u></p> | 42535858 | 970102 |
|  | | | |
| Connessione / Connected: 970131-970132 | | | |
| Daily 45/49.10/12 | <ul style="list-style-type: none"> - Kit riparazione per un assale/ <i>Repairing kit for one axle</i> | -- | 962288 |
|  | | | |
| Connessione / Connected: 962075-962076 | | | |
| 115.14/17 135.14/17 145.17 | <ul style="list-style-type: none"> - Ganaschia nuda/<i>Naked brake shoe</i> - Singolo/<i>Single</i> - Senza ceppi/<i>Without lining</i> - Ø mm. 360 x 170 <p><i>Perrot system</i></p> | -- | 961056 |
|  | | | |
| Connessione / Connected: 961008 | | | |
|  | | | |

I riferimenti indicati non sono originali ma perfettamente intercambiabili. I codici originali e le case costruttrici sono indicati a puro titolo informativo
The details described are not original but perfectly interchangeable. The original references and manufacturer names are given for information purposes only.

EMMERRE

spare parts for trucks and trailers

IVECO

GANASCE FRENO
BRAKE SHOES
MACHOIRES DE FREIN
BREMSBACKEN
БАРАБАННЫЕ КОЛОДКИ
MORDAZAS DE FRENO

| Emmerre | Adattabile a / Adaptable to | Dettagli / Detail | Applicazioni / Applications |
|--|-----------------------------|--|----------------------------------|
| 961008  | 1906128 12999347VT | - Serie ganasce complete/ <i>Set complete brake shoes</i> - Posteriore/Rear - Ø mm. 360 x 170 <i>Perrot system</i> | 115.14/17 135.14/17 145.17 |
| | | Connessione / Connected:  961056  | AC1976 |
| 963545  | 1906354 | - Posteriore/Rear - Ø mm. 381 x 180 <i>Rockwell system</i> | Eurocargo Eurocargo Tector |
| | | Connessione / Connected:  | 963907-963908 |
| 963519  | -- | - Ganasca nuda/ <i>Naked brake shoe</i> - Con fori indicatori usura freno/ <i>With wear brake indicator holes</i> - Singolo/Single - Ø mm. 360 x 170 <i>Perrot system</i> | Eurocargo Tector |
| | | Connessione / Connected:  | 963526 |
| 963526  | 1906361 12999469VT | - Posteriore/Rear - Ø mm. 360 x 170 <i>Perrot system</i> | Eurocargo Tector |
| | | Connessione / Connected:  963900-963901  | 963519 |

**GANASCE FRENO
BRAKE SHOES
MACHOIRES DE FREIN
BREMSBACKEN
БАРАБАННЫЕ КОЛОДКИ
MORDAZAS DE FRENO**

EMMERRE
spare parts for trucks and trailers

IVECO

| Applicazioni / Applications | Dettagli / Detail | Adattabile a / Adaptable to | Emmerre |
|---|---|-----------------------------|---------------|
| Eurocargo Tector | <ul style="list-style-type: none"> - Serie ganasce complete/ <i>Set complete brake shoes</i> - Posteriore/Rear - Ø 360 x 170 mm. <p><u>Meritor system</u></p> | 2992530 | 963614 |
|  | | | |
| Connessione / Connected:  963905-963906 | | | |
| Turbostar Turbotech | <ul style="list-style-type: none"> - Ganasca nuda/<i>Naked brake shoe</i> - Senza ceppi/<i>Without lining</i> - Singolo/<i>Single</i> | -- | 961055 |
|  | | | |
| Connessione / Connected:  963069-963068  961013 | | | |
| Turbostar Turbotech | <ul style="list-style-type: none"> - Serie ganasce complete/ <i>Set complete brake shoes</i> - Posteriore/Rear - Ø mm. 381 x 178 | 1906032 RBSK1212 | 961013 |
|  | | | |
| Connessione / Connected:  963068-963069 | | | |
| Eurotech Eurostar Eurotrakker Cursor | <ul style="list-style-type: none"> - Serie ganasce complete/ <i>Set complete brake shoes</i> - Anteriore/Front - Ø mm. 410 x 180 <p><u>Rockwell system</u></p> | 1906404 RBSK1496 | 963529 |
|  | | | |
| Connessione / Connected:  963456-963457 | | | |

I riferimenti indicati non sono originali ma perfettamente intercambiabili. I codici originali e le case costruttrici sono indicati a puro titolo informativo
The details described are not original but perfectly interchangeable. The original references and manufacturer names are given for information purposes only.

EMMERRE

spare parts for trucks and trailers

IVECO

GANASCE FRENO BRAKE SHOES MACHOIRES DE FREIN BREMSBACKEN БАРАБАННЫЕ КОЛОДКИ MORDAZAS DE FRENO

| Emmerre | Adattabile a / Adaptable to | Dettagli / Detail | Applicazioni / Applications |
|---|--------------------------------|---|---|
| 963520 | -- | <ul style="list-style-type: none">- Ganasce nude/<i>Naked brake shoe</i>- Con fori indicatori usura freno/<i>With wear brake indicator holes</i>- Singolo/<i>Single</i>- Posteriore/<i>Rear</i>- Ø mm. 410 x 200 <p><i>Rockwell system</i></p> | Eurotech Eurostar Eurotrakker Cursor |
|  | | | |
| Connessione / Connected: | |  963531 |  963551-963552 |
| 963521 | -- | <ul style="list-style-type: none">- Ganasce nude/<i>Naked brake shoe</i>- Senza fori indicatori usura freno/<i>Without wear brake indicator holes</i>- Singolo/<i>Single</i>- Posteriore/<i>Rear</i>- Ø mm. 410 x 200 <p><i>Rockwell system</i></p> | Eurotech Eurostar Eurotrakker Cursor |
|  | | | |
| Connessione / Connected: | |  963531 |  963551-963552 |
| 963531 | 1906410 1906368 RBSK1493 | <ul style="list-style-type: none">- Serie ganasce complete/<i>Set complete brake shoes</i>- Posteriore/<i>Rear</i>- Ø mm. 410 x 200 <p><i>Rockwell system</i></p> | Eurotech Eurostar Eurotrakker Cursor |
|  | | | |
| Connessione / Connected: | |  963551-963552 |  963520-963521 |
| 963522 | -- | <ul style="list-style-type: none">- Ganasce nude/<i>Naked brake shoe</i>- Singolo/<i>Single</i>- Spoglio/<i>Naked</i>- Posteriore/<i>Rear</i>- Ø mm. 410 x 200 <p><i>Perrot system</i></p> | Eurotech Eurostar Eurotrakker Cursor Stralis |
|  | | | |
| Connessione / Connected: | |  963559 |  963558 |

**GANASCE FRENO
BRAKE SHOES
MACHOIRES DE FREIN
BREMSBACKEN
БАРАБАННЫЕ КОЛОДКИ
MORDAZAS DE FRENO**

EMMERRE
spare parts for trucks and trailers

IVECO

| Applicazioni / Applications | Dettagli / Detail | Adattabile a / Adaptable to | Emmerre |
|---|---|-----------------------------|---------------|
| Eurotech Eurostar Eurotrakker Cursor Stralis | - Serie ganasce complete/ <i>Set complete brake shoes</i> - Posteriore/Rear - Ø mm. 410 x 200 <i>Perrot system</i> | 2991759 12999711VT | 963559 |
|  | | | |
| Connessione / Connected:  963557-963558  963522 | | | |
| Eurotech Eurostar Eurotrakker Cursor Stralis | - Ganaschia nuda/ <i>Naked brake shoe</i> - Singolo/Single - Spoglio/Naked - Anteriore/Front - Ø mm. 410 x 180 <i>Perrot system</i> | -- | 963528 |
|  | | | |
| Connessione / Connected:  963902-963903  963615 | | | |
| Eurotech Eurostar Eurotrakker Cursor Stralis | - Serie ganasce complete/ <i>Set complete brake shoes</i> - Anteriore/Front - Ø mm. 410 x 180 <i>Perrot system</i> | 2991755 12999709VT | 963615 |
|  | | | |
| Connessione / Connected:  963902-963903  963528 | | | |
| Eurotrakker Cursor Stralis | - Ganaschia nuda/ <i>Naked brake shoe</i> - Senza fori indicatori usura freno/ <i>Without wear brake indicator holes</i> - Singolo/Single - Anteriore/Front - Ø mm. 410 x 180 <i>Meritor system</i> | -- | 963498 |
|  | | | |
| Connessione / Connected:  963590 | | | |

I riferimenti indicati non sono originali ma perfettamente intercambiabili. I codici originali e le case costruttrici sono indicati a puro titolo informativo
The details described are not original but perfectly interchangeable. The original references and manufacturer names are given for information purposes only.

EMMERRE

spare parts for trucks and trailers

IVECO

GANASCE FRENO BRAKE SHOES MACHOIRES DE FREIN BREMSBACKEN БАРАБАННЫЕ КОЛОДКИ MORDAZAS DE FRENO

| Emmerre | Adattabile a / Adaptable to | Dettagli / Detail | Applicazioni / Applications |
|--|---|---|----------------------------------|
| 963590  | 2992375 42537726 2992110 | - Serie ganasce complete/ <i>Set complete brake shoes</i> - Anteriore/ <i>Front</i> - Ø mm. 410 x 180 <i>Meritor system</i> | Eurotrakker Cursor Stralis |
| | | Connessione / Connected:  963498 | |
| 963499  | -- | - Senza fori indicatori usura freno/ <i>Without wear brake indicator holes</i> - Singolo/ <i>Single</i> - Spoglio/ <i>Naked</i> - Posteriore/ <i>Rear</i> - Ø mm. 410 x 200 <i>Meritor system</i> | Eurotrakker Cursor Stralis |
| | | Connessione / Connected:  963570-963571  963591 | |
| 963591  | 2992378 42537727 2992120 2991630 | - Duplex - Serie ganasce complete/ <i>Set complete brake shoes</i> - Posteriore/ <i>Rear</i> - Ø 410 x 200 mm. <i>Meritor system</i> | Eurotrakker Cursor Stralis |
| | | Connessione / Connected:  963570-963571  963499 | |
| 963128  | 2992379 2992121 | - Duplex - Serie ganasce complete/ <i>Set complete brake shoes</i> - Posteriore/ <i>Rear</i> - Aumentato/ <i>Increased 10/10</i> - Ø 410 x 200 mm. <i>Meritor system</i> | Eurotrakker Cursor |
| | | Connessione / Connected:  963570-963571 | |



**GANASCE FRENO
BRAKE SHOES
MACHOIRES DE FREIN
BREMSBACKEN
БАРАБАННЫЕ КОЛОДКИ
MORDAZAS DE FRENO**

EMMERRE
spare parts for trucks and trailers

IVECO

| Applicazioni / Applications | Dettagli / Detail | Adattabile a / Adaptable to | Emmerre |
|---|---|-----------------------------|---------------|
| Eurotrakker Cursor | <ul style="list-style-type: none"> - Serie ganasce complete/ <i>Set complete brake shoes</i> - Duplex - Posteriore/<i>Rear</i> - Aumentato/<i>Increased 20/10</i> - Ø 410 x 200 mm. <p><u>Meritor system</u></p> | 2992380 2992122 | 963129 |
|  | | | |
| Connessione / Connected: 963570-963571 | | | |
| Eurotrakker Cursor Trakker | <ul style="list-style-type: none"> - Serie ganasce complete/ <i>Set complete brake shoes</i> - Duplex - Anteriore/<i>Front</i> - Ø 410 x 180 mm. <p><u>Meritor system</u></p> | 2995821 | 963121 |
| Eurotrakker Cursor Trakker | <ul style="list-style-type: none"> - Serie ganasce complete/ <i>Set complete brake shoes</i> - Duplex - Posteriore/<i>Rear</i> - Ø 410 x 200 mm. <p><u>Meritor system</u></p> | 2995824 | 963543 |
| Eurotrakker Cursor Trakker | <ul style="list-style-type: none"> - Serie ganasce complete/ <i>Set complete brake shoes</i> - Duplex - Posteriore/<i>Rear</i> - Aumentato/<i>Increased 10/10</i> - Ø 410 x 200 mm. <p><u>Meritor system</u></p> | 2995825 | 963122 |



| Emmerre | Adattabile a / Adaptable to | Dettagli / Detail | Applicazioni / Applications |
|---|-----------------------------|--|--|
| 963123 | 2995826 | - Serie ganasce complete/ <i>Set complete brake shoes</i> - Duplex - Posteriore/Rear - Aumentato/Increased 20/10 - Ø 410 x 200 mm. <i>Meritor system</i> | Eurotrakker Cursor |
|  | | | |
| 960561 | 2992448 | - Serie ganasce complete/ <i>Set complete brake shoes</i> - Duplex - Posteriore/Rear - Ø 410 x 200 mm. <i>Meritor system</i> | Bus Euroclass Eurorider Turbocity |
|  | | | |
| 963623 | 2992376 | - Serie ganasce complete/ <i>Set complete brake shoes</i> - Anteriore/Front - Ø 410 x 180 mm. - 1^ maggiorazione/Increase | Eurotrakker Cursor Stralis |
|  | | | |

**GANASCE FRENO
BRAKE SHOES
MACHOIRES DE FREIN
BREMSBACKEN
БАРАБАННЫЕ КОЛОДКИ
MORDAZAS DE FRENO**

EMMERRE
spare parts for trucks and trailers

MAN

| Applicazioni / Applications | Dettagli / Detail | Adattabile a / Adaptable to | Emmerre |
|-----------------------------|---|---|---------------|
| F 90 F 2000 | - Ganascia nuda/ <i>Naked brake shoe</i> - Ø mm. 410 x 220 | 81502016114 81502016218 81502016185 | 963750 |



| | |
|--------------------------|--|
| Connessione / Connected: |  AC2125 |
|--------------------------|--|

| | | | |
|----------------|---|-------------|---------------|
| F 90 F 2000 | - Ganascia nuda/ <i>Naked brake shoe</i> - Ø mm. 410 x 180 | 81502016184 | 963751 |
|----------------|---|-------------|---------------|





| | |
|--------------------------|--|
| Connessione / Connected: |  AC2126 |
|--------------------------|--|



| Emmerre | Adattabile a / Adaptable to | Dettagli / Detail | Applicazioni / Applications |
|--|--|---|--|
| 963750 | 6204200119 6204200319 6244200019 | - Ganasce nuda/ <i>Naked brake shoe</i> - Ø mm. 410 x 220 | Actros Actros MP2 Actros MP3 Atego Axor Axor II MK - NG - SK |
| Connessione / Connected: | | |  AC2125 |
| 963754 | 6394200220 | - Serie ganasce complete/ <i>Set complete brake shoes</i> - Per freno a mano/ <i>For hand brake</i> - Posteriore/ <i>Rear</i> - Ø mm. 186 x 20 <i>Bosch system</i> | Viano Vito |
|  | | | |

**GANASCE FRENO
BRAKE SHOES
MACHOIRES DE FREIN
BREMSBACKEN
БАРАБАНЫЕ КОЛОДКИ
MORDAZAS DE FRENO**

EMMERRE
spare parts for trucks and trailers

NISSAN

| Applicazioni / Applications | Dettagli / Detail | Adattabile a / Adaptable to | Emmerre |
|-----------------------------|--|---|---------------|
| Cabstar Trade | - Serie ganasce complete/ <i>Set complete brake shoes</i> - Posteriore/Rear - Ø mm. 254 x 57 <u>Lucas Girling system</u> | 06905320-0 069029000 | 960873 |
| | |  | |
| Cabstar | - Serie ganasce complete/ <i>Set complete brake shoes</i> - Posteriore/Rear - Ø mm. 280 x 65 | 440609X127 440609X129 440600X825 | 961062 |
| | |  | |
| | | | |
| | | | |

| Emmerre | Adattabile a / Adaptable to | Dettagli / Detail | Applicazioni / Applications |
|--|--|--|--|
| 970100 | 5001860144 5001844749 | - Serie ganasce complete/ <i>Set complete brake shoes</i> - Per freno a mano/ <i>For hand brake</i> - Posteriore/ <i>Rear</i> - Ø mm. 172 x 42 <i>Brembo system</i> | Mascott 1999 Mascott 2000 Mascott 2001 Mascott 2004 |
|  | | | |
| 960873 | 7701201617 7701202897 7701203072 | - Serie ganasce complete/ <i>Set complete brake shoes</i> - Posteriore/ <i>Rear</i> - Ø mm. 254 x 57 <i>Lucas Girling system</i> | Trafic Master |
|  | | | |
| | | | |
| | | | |

**GANASCE FRENO
BRAKE SHOES
MACHOIRES DE FREIN
BREMSBACKEN
БАРАБАНЫЕ КОЛОДКИ
MORDAZAS DE FRENO**

EMMERRE
spare parts for trucks and trailers

ROR

| Applicazioni / Applications | Dettagli / Detail | Adattabile a / Adaptable to | Emmerre |
|-----------------------------|--|-----------------------------|---------------|
| Series TE Series TM | - Serie ganasce complete/ <i>Set complete brake shoes</i> - Ø mm. 419 x 178 - Per una ruota/ <i>For one wheel</i> | OMBSK1000-20 15205533 | 960566 |
| Series LM Series LMC | - Serie ganasce complete/ <i>Set complete brake shoes</i> - Ø mm. 419 x 178 - Per una ruota/ <i>For one wheel</i> | OMBSK1040-20 15224724 | 960567 |
| Series TE Series TM | - Serie ganasce complete/ <i>Set complete brake shoes</i> - Ø mm. 419 x 178 - Per assale/ <i>For axle</i> | OMBSK1000-40 15205533 | 960568 |
| Series LM Series LMC | - Serie ganasce complete/ <i>Set complete brake shoes</i> - Ø mm. 419 x 178 - Per assale/ <i>For axle</i> | OMBSK1040-40 15224724 | 960569 |



I riferimenti indicati non sono originali ma perfettamente intercambiabili. I codici originali e le case costruttrici sono indicati a puro titolo informativo
The details described are not original but perfectly interchangeable. The original references and manufacturer names are given for information purposes only.

| Emmerre | Adattabile a / Adaptable to | Dettagli / Detail | Applicazioni / Applications |
|--|-----------------------------|---|--|
| 960586 | 15205533 | - Ganaschia nuda/ <i>Naked brake shoe</i> | Series TE Series TM |
|  | | | |
| | | | Connessione / Connected:  960566-960568 |
| 960587 | 15224724 | - Ganaschia nuda/ <i>Naked brake shoe</i> | Series LM Series LME |
|  | | | |
| | | | Connessione / Connected:  960567-960569 |

GANASCE FRENO
BRAKE SHOES
MACHOIRES DE FREIN
BREMSBACKEN
БАРАБАНЫЕ КОЛОДКИ
MORDAZAS DE FRENO



EMMERRE
spare parts for trucks and trailers

SAF

| Applicazioni / Applications | Dettagli / Detail | Adattabile a / Adaptable to | Emmerre |
|-----------------------------|--|-----------------------------|---------------|
| | - Ganaschia nuda/ <i>Naked brake shoe</i> - Ø mm. 420 x 180 | 3054012000 | 963700 |



| | |
|--------------------------|--|
| Connessione / Connected: |  AS5061 |
|--------------------------|--|

| Emmerre | Adattabile a / Adaptable to | Dettagli / Detail | Applicazioni / Applications |
|--|-----------------------------|---|---|
| 963800 | 1104544 1104548 | - Ganasce nuda/ <i>Naked brake shoe</i> - Ø mm. 413 x 203 | Series 3 Series 4 Series P/G/R/T |
|  | | | Connessione / Connected:  AC2134 |
| 963802 | 1104545 1104549 | - Ganasce nuda/ <i>Naked brake shoe</i> - Ø mm. 413 x 254 - 16 fori/ <i>holes</i> | Series 3 Series 3 Bus Series P/G/R/T |
|  | | | Connessione / Connected:  AC2135 |

**GANASCE FRENO
BRAKE SHOES
MACHOIRES DE FREIN
BREMSBACKEN
БАРАБАННЫЕ КОЛОДКИ
MORDAZAS DE FRENO**

EMMERRE
spare parts for trucks and trailers

VOLVO

| Applicazioni / Applications | Dettagli / Detail | Adattabile a / Adaptable to | Emmerre |
|---|--|-----------------------------|---------------|
| FH FM | - Serie ganasce nude/ <i>Set naked brake shoes</i> - Ø mm. 410 x 175 | 3095195 | 963850 |
|  | | | |
| Connessione / Connected:  AC2137 | | | |
| FH FM | - Serie ganasce nude/ <i>Set naked brake shoes</i> - Ø mm. 410 x 200 | 3095196 240377 | 963851 |
|  | | | |
| Connessione / Connected:  AC2138 | | | |
| F FL FH | - Serie ganasce nude/ <i>Set naked brake shoes</i> - Ø mm. 410 x 225 | 3095197 | 963852 |
|  | | | |
| Connessione / Connected:  AC2139 | | | |
| FL 6 FL 7 FL 10 FL 12 FH 12 FH 16 | - Serie ganasce nude/ <i>Set naked brake shoes</i> - Ø mm. 410 x 175 | 3090075 272842 270827 | 963853 |
|  | | | |

I riferimenti indicati non sono originali ma perfettamente intercambiabili. I codici originali e le case costruttrici sono indicati a puro titolo informativo
The details described are not original but perfectly interchangeable. The original references and manufacturer names are given for information purposes only.

EMMERRE
spare parts for trucks and trailers

VOLVO

**GANASCE FRENO
BRAKE SHOES
MACHOIRES DE FREIN
BREMSBACKEN
БАРАБАННЫЕ КОЛОДКИ
MORDAZAS DE FRENO**

| Emmerre | Adattabile a / Adaptable to | Dettagli / Detail | Applicazioni / Applications |
|---|-----------------------------|--|--|
| 963854 | 3090076 272843 270828 | - Serie ganasce nude/ <i>Set naked brake shoes</i> - Ø mm. 410 x 200 | F 10 - 12 - 16 FL 6 - 7 - 10 - 12 FH 12 - 16 FM 7 - 9 - 12 NH 12 |
|  | | | |
| | | | |
| | | | |
| | | | |

**KIT RIPARAZIONE
REPAIRING KIT
KIT REPARATION
REPARATURSATZ
РЕМКОМПЛЕКТЫ
JUEGO DE REPARACION**

EMMERRE
spare parts for trucks and trailers

DAF

| Applicazioni / Applications | Dettagli / Detail | Adattabile a / Adaptable to | Emmerre |
|-----------------------------|---|---|---------------|
| Trucks | - Kit cuscinetti/Bearings kit - Ø mm. 36 x 21,50 <u>Perrot system</u> | 1518476 FBU7501 12999403VT | 963622 |
| | |  | |
| Trucks | - Kit cilindri freno/Brake cylinder kit <u>Perrot system</u> | 1505885 FBU7499 12999418VT | 963019 |
| | |  | |
| Trucks | - Kit cunei freno/Brake wedges kit <u>Perrot system</u> | 1518475 FBU9123 12999402VT | 963554 |
| | |  | |
| Trucks | - Registro freno/Brake adjuster <u>Perrot system</u> | 1505894 13730103 | 964215 |
| | |  | |

I riferimenti indicati non sono originali ma perfettamente intercambiabili. I codici originali e le case costruttrici sono indicati a puro titolo informativo
The details described are not original but perfectly interchangeable. The original references and manufacturer names are given for information purposes only.

657

| Emmerre | Adattabile a / <i>Adaptable to</i> | Dettagli / <i>Detail</i> | Applicazioni / <i>Applications</i> |
|---|------------------------------------|---|------------------------------------|
| 963021 | 1518465 12999134VT | - Kit registro cunei freno/ <i>Brake adjuster wedges kit</i> | Trucks |
|  | | | |
| 963002 | 1505874 12999011VT | - Kit cuffie/ <i>Protective hoods set</i> | Trucks |
|  | | | |
| 960511 | 1258802 RBSK1255M | - Kit cunei freno/ <i>Brake wedges kit</i> <i>Meritor system</i> | Trucks |
|  | | | |
| 963553 | 1505883 12999410VT | - Kit cunei freno/ <i>Brake wedges kit</i> <i>Perrot system</i> | Trucks |
|  | | | |

**KIT RIPARAZIONE
REPAIRING KIT
KIT REPARATION
REPARATURSATZ
РЕМКОМПЛЕКТЫ
JUEGO DE REPARACION**

EMMERRE
spare parts for trucks and trailers

DAF

| Applicazioni / Applications | Dettagli / Detail | Adattabile a / Adaptable to | Emmerre |
|-----------------------------|--|-----------------------------|---------------|
| Trucks | - Kit cuffie alte e basse/ <i>High and low Protective hoods set</i> | 1505875 12999063VT | 963004 |



| | | | |
|--------|---|-------------------|---------------|
| Trucks | - Membrana corta tipo/ <i>Membrane short type 9"</i> - Ø mm. 128 x 30 - Battuta/ <i>Stroke</i> mm.44 | 1257928 709116 | 970801 |
|--------|---|-------------------|---------------|



| | | | |
|--------|--|--------|---------------|
| Trucks | - Membrana corta tipo/ <i>Membrane short type 16"</i> - Ø mm. 158 x 36 - Battuta/ <i>Stroke</i> mm.57 | 721187 | 970803 |
|--------|--|--------|---------------|



| | | | |
|--------|--|-------------------|---------------|
| Trucks | - Membrana corta tipo/ <i>Membrane short type 20"</i> - Ø mm. 168 x 38 - Battuta/ <i>Stroke</i> mm.57 | FBU8676 303055 | 970804 |
|--------|--|-------------------|---------------|





I riferimenti indicati non sono originali ma perfettamente intercambiabili. I codici originali e le case costruttrici sono indicati a puro titolo informativo
The details described are not original but perfectly interchangeable. The original references and manufacturer names are given for information purposes only.

| Emmerre | Adattabile a / Adaptable to | Dettagli / Detail | Applicazioni / Applications |
|---|--|--|-----------------------------|
| 970805 | FBU8648 312940 0706123 501182 | - Membrana corta tipo/ <i>Membrane short type 24"</i> - Ø mm. 178 x 42 - Battuta/ <i>Stroke</i> mm.64 | Trucks |
|  | | | |
| 970806 | 0305049 0706128 5334585 | - Membrana corta tipo/ <i>Membrane short type 30"</i> - Ø mm. 201 x 36 - Battuta/ <i>Stroke</i> mm.64 | Trucks |
|  | | | |
| 970809 | 0067185 | - Membrana lunga tipo/ <i>Membrane long type 16"</i> - Ø mm. 158 x 58 - Battuta/ <i>Stroke</i> mm.44 | Trucks |
|  | | | |
| 970810 | 0689366 | - Membrana lunga tipo/ <i>Membrane long type 20"</i> - Ø mm. 168 x 50 - Battuta/ <i>Stroke</i> mm.76 | Trucks |
|  | | | |

**KIT RIPARAZIONE
REPAIRING KIT
KIT REPARATION
REPARATURSATZ
РЕМКОМПЛЕКТЫ
JUEGO DE REPARACION**

EMMERRE
spare parts for trucks and trailers

DAF

| Applicazioni / Applications | Dettagli / Detail | Adattabile a / Adaptable to | Emmerre |
|-----------------------------|---|-----------------------------|--|
| Trucks | - Membrana lunga tipo/ <i>Membrane long type 24"</i> - Ø mm. 178 x 52 - Battuta/Stroke mm.76 | 691763 695751 | 970811 |
| | | |  |
| Trucks | - Membrana lunga tipo/ <i>Membrane long type 30"</i> - Ø mm. 203 x 52 - Battuta/Stroke mm.76 | 0691602 0694277 | 970812 |
| | | |  |
| | | | |
| | | | |

| Emmerre | Adattabile a / Adaptable to | Dettagli / Detail | Applicazioni / Applications |
|---|-----------------------------|---|-----------------------------|
| 961044 | -- | - Set molle per ganasce freno posteriori/ Springs set for rear brake shoes set | Ducato |
|  | | | |

GASOLONE

| Emmerre | Adattabile a / Adaptable to | Dettagli / Detail | Applicazioni / Applications |
|---|-----------------------------|---------------------------------|-----------------------------|
| 960252 | RI412536200 | - Cilindro freno/Brake cylinder | TS 27/28 1° Serie |
|  | | | |

**KIT RIPARAZIONE
REPAIRING KIT
KIT REPARATION
REPARATURSATZ
РЕМКОМПЛЕКТЫ
JUEGO DE REPARACION**

EMMERRE
spare parts for trucks and trailers

IVECO

| Applicazioni / Applications | Dettagli / Detail | Adattabile a / Adaptable to | Emmerre |
|---|--|-----------------------------|---------------|
| Daily Restyling New Daily TurboDaily | - Kit riparazione freni/Brake repairing kit - Senza cilindro/Without cylinder - Posteriore/Rear - Sinistra/Left - Ruota singola/Single wheel | -- | 963085 |
|  | | | |
| Connessione / Connected:  963086-963098-963114 | | | |
| Daily Restyling New Daily TurboDaily | - Kit riparazione freni/Brake repairing kit - Senza cilindro/Without cylinder - Posteriore/Rear - Destra/Right - Ruota singola/Single wheel | -- | 963084 |
|  | | | |
| Connessione / Connected:  963087-963097-963115 | | | |
| Daily Restyling New Daily TurboDaily | - Kit riparazione freni/Brake repairing kit - Sinistra/Left | 8124927 | 963101 |
|  | | | |
| Connessione / Connected:  963086-963098-963114 | | | |
| Daily Restyling New Daily TurboDaily | - Kit riparazione freni/Brake repairing kit - Destra/Right | 8124924 | 963100 |
|  | | | |
| Connessione / Connected:  963087-963097-963115 | | | |

I riferimenti indicati non sono originali ma perfettamente intercambiabili. I codici originali e le case costruttrici sono indicati a puro titolo informativo
The details described are not original but perfectly interchangeable. The original references and manufacturer names are given for information purposes only.

| Emmerre | Adattabile a / Adaptable to | Dettagli / Detail | Applicazioni / Applications |
|---|-----------------------------|---|--|
| 963116 | -- | - Kit riparazione freni/ <i>Brake repairing kit</i> - Senza registro freno/ <i>Without Brake adjuster</i> - Sinistra/ <i>Left</i> | Daily Restyling New Daily Turbodaily |
|  | | | |
| Connessione / Connected: | | |  963086-963098-963114 |
| 963117 | -- | - Kit riparazione freni/ <i>Brake repairing kit</i> - Senza registro freno/ <i>Without Brake adjuster</i> - Destra/ <i>Right</i> | Daily Restyling New Daily Turbodaily |
|  | | | |
| Connessione / Connected: | | |  963087-963097-963115 |
| 960884 | 8124928 | - Kit leva sinistra freno/ <i>Brake lever kit left</i> | Daily Restyling New Daily Turbodaily |
|  | | | |
| Connessione / Connected: | | |  963086-963098-963114 |
| 960883 | 8124925 | - Kit leva destra freno/ <i>Brake lever kit right</i> | Daily Restyling New Daily Turbodaily |
|  | | | |
| Connessione / Connected: | | |  963087-963097-963115 |

**KIT RIPARAZIONE
REPAIRING KIT
KIT REPARATION
REPARATURSATZ
РЕМКОМПЛЕКТЫ
JUEGO DE REPARACION**

EMMERRE
spare parts for trucks and trailers

IVECO

| Applicazioni / Applications | Dettagli / Detail | Adattabile a / Adaptable to | Emmerre |
|--|---|-----------------------------|---------------|
| Daily Restyling New Daily Turbodaily | - Set molle freno/ <i>Brake Springs set</i> - Sinistra/ <i>Left</i> - Con 5ª molla/ <i>With 5° spring</i> | 93161124 | 963089 |
|  | | | |
| Connessione / Connected: 963086-963098-963114 | | | |
| Daily Restyling New Daily Turbodaily | - Set molle freno/ <i>Brake Springs set</i> - Destra/ <i>Right</i> - Con 5ª molla/ <i>With 5° spring</i> | 93161123 | 963088 |
|  | | | |
| Connessione / Connected: 963087-963097-963115 | | | |
| Daily Restyling New Daily Turbodaily | - Set molle freno/ <i>Brake Springs set</i> <i>Perrot system</i> | 8124934 | 961523 |
|  | | | |
| Connessione / Connected: 962075-962076 | | | |
| Turbozeta Zeta | - Set leve per freno a mano/ <i>Levers set for hand brake</i> | -- | 963597 |
|  | | | |
| Connessione / Connected: 963110-963111  963616-961037 | | | |



I riferimenti indicati non sono originali ma perfettamente intercambiabili. I codici originali e le case costruttrici sono indicati a puro titolo informativo
The details described are not original but perfectly interchangeable. The original references and manufacturer names are given for information purposes only.

EMMERRE

spare parts for trucks and trailers

IVECO

KIT RIPARAZIONE REPAIRING KIT KIT REPARATION REPARATURSATZ РЕМКОМПЛЕКТЫ JUEGO DE REPARACION

| Emmerre | Adattabile a / Adaptable to | Dettagli / Detail | Applicazioni / Applications |
|--|----------------------------------|--|--|
| 961045  | 42556773 42536259 93161850 | - Kit riparazione freni/ <i>Brake repairing kit</i> - Per freno a mano/ <i>For hand brake</i> | Daily City 2000 New Daily '96 Turbodaily '96 |
| | | Connessione / Connected:  970131-970132-970103-970104 | |
| 961046  | 42556902 93161851 | - Kit riparazione freni/ <i>Brake repairing kit</i> - Per freno a mano/ <i>For hand brake</i> | Daily City 2000 New Daily '96 Turbodaily '96 |
| | | Connessione / Connected:  970103-970104 | |
| 961047  | 93161852 | - Kit riparazione freni/ <i>Brake repairing kit</i> - Per freno a mano/ <i>For hand brake</i> | Daily City 2000 New Daily '96 Turbodaily '96 |
| | | Connessione / Connected:  970131-970132-970103-970104 | |
| 963525  | 42530368 42556903 | - Leva per freno a mano/ <i>Lever for hand brake</i> | Daily City 2000 Daily '96 |
| | | Connessione / Connected:  970103-970104 | |

**KIT RIPARAZIONE
REPAIRING KIT
KIT REPARATION
REPARATURSATZ
РЕМКОМПЛЕКТЫ
JUEGO DE REPARACION**

EMMERRE
spare parts for trucks and trailers

IVECO

| Applicazioni / Applications | Dettagli / Detail | Adattabile a / Adaptable to | Emmerre |
|--|--|-----------------------------|---------------|
| Daily City 2000 | - Leva per freno a mano/ <i>Lever for hand brake</i> | 42556775 42535860 | 963598 |
|  | | | |
| Connessione / Connected:  500369260-500369261-970131-970132 | | | |
| Daily City 2000 | - Set molle/ <i>Springs set</i> | 42556774 42535859 | 963618 |
|  | | | |
| Connessione / Connected:  970131-970132 | | | |
| 115.14/17 135.14/17 145.17 Eurocargo Eurocargo Tector | - Kit cuscinetti/ <i>Bearings kit</i> - Ø 36 x 21,50 mm <i>Perrot system</i> | 93161268 12999403VT | 963622 |
|  | | | |
| Connessione / Connected:  963900-963901 | | | |
| 115.14/17 135.14/17 145.17 Eurocargo Tector Eurotech Eurotrakker Cursor | - Kit cilindri freno/ <i>Brake cylinder kit</i> <i>Perrot system</i> | 93161254 12999418VT | 963019 |
|  | | | |
| Connessione / Connected:  963900-963901 | | | |

I riferimenti indicati non sono originali ma perfettamente intercambiabili. I codici originali e le case costruttrici sono indicati a puro titolo informativo
The details described are not original but perfectly interchangeable. The original references and manufacturer names are given for information purposes only.

EMMERRE

spare parts for trucks and trailers

IVECO





KIT RIPARAZIONE REPAIRING KIT KIT REPARATION REPARATURSATZ РЕМКОМПЛЕКТЫ JUEGO DE REPARACION

| Emmerre | Adattabile a / Adaptable to | Dettagli / Detail | Applicazioni / Applications |
|---|-----------------------------|--|---|
| 963599 | 93161257 12999404 | - Kit cuffie per cilindro freno/ <i>Protective hoods set for brake cylinder</i> <i>Perrot system</i> | 115.14/17 135.14/17 145.17 Eurocargo Tector Eurotech Eurotrakker Cursor |
|  | | | |
| Connessione / Connected: | | |  963900-963901 |
| 963554 | 93161267 12999402VT | - Kit cunei freno/ <i>Brake wedges kit</i> <i>Perrot system</i> | 115.14/17 135.14/17 145.17 Eurocargo Eurocargo Tector |
|  | | | |
| Connessione / Connected: | | |  963900-963901 |
| 963619 | 93161183 12999356VT | - Kit molle/ <i>Springs kit</i> <i>Perrot system</i> | Eurocargo |
|  | | | |
| 963620 | 8121441 13304029 | - Molla ganasce freno/ <i>Brake spring shoes</i> <i>Perrot system</i> | Eurotech Eurotech Cursor Eurostar Eurotrakker Eurotrakker Cursor Stralis |
|  | | | |

**KIT RIPARAZIONE
REPAIRING KIT
KIT REPARATION
REPARATURSATZ
РЕМКОМПЛЕКТЫ
JUEGO DE REPARACION**

EMMERRE
spare parts for trucks and trailers

IVECO

| Applicazioni / Applications | Dettagli / Detail | Adattabile a / Adaptable to | Emmerre |
|---|---|---|---------------|
| Eurocargo Tector | - Set molle freno/ <i>Brake Springs set</i> <i>Perrot System</i> | 93161954 | 961043 |
| | |  | |
| Eurotech Eurotech Cursor Eurostar Eurotrakker Eurotrakker Cursor Stralis | - Set molle freno/ <i>Brake Springs set</i> <i>Perrot system</i> | 93161260 12999443VT | 963556 |
| | |  | |
| 115.14/17 135.14/17 145.17 | - Registro freno/ <i>Brake adjuster</i> <i>Perrot system</i> | 9987624 13730103 | 964215 |
| | |  | |
| 115.14/17 135.14/17 145.17 | - Molla/ <i>Spring</i> <i>Perrot system</i> | 42488219 13304019 | 964218 |
| | |  | |

I riferimenti indicati non sono originali ma perfettamente intercambiabili. I codici originali e le case costruttrici sono indicati a puro titolo informativo
The details described are not original but perfectly interchangeable. The original references and manufacturer names are given for information purposes only.

EMMERRE

spare parts for trucks and trailers

IVECO

KIT RIPARAZIONE REPAIRING KIT KIT REPARATION REPARATURSATZ РЕМКОМПЛЕКТЫ JUEGO DE REPARACION

| Emmerre | Adattabile a / Adaptable to | Dettagli / Detail | Applicazioni / Applications |
|--|-----------------------------|--|-------------------------------------|
| 963003  | 8124815 12999135VT | - Kit cuscinetti/Bearings kit - Ø 36 x 18 mm <i>Perrot system</i> | 115.14/17 135.14/17 145.17 |
| 963021  | 8124814 12999134VT | - Kit registro cunei freno/ Brake adjuster wedges kit <i>Perrot system</i> | 115.14/17 135.14/17 145.17 |
| Connessione / Connected:  | | | 963900-963901 |
| 963002  | 8124031 12999011VT | - Kit cuffie/Protective hoods set <i>Perrot system</i> | 115.14/17 135.14/17 145.17 |
| 963106  | 42480411 3211J302635 | - Supporto massa freno/Brake wheel support - Simplex <i>Meritor system</i> | 175.17/24 Turbotech Turbostar |
| Connessione / Connected:  | | | 963068-963069 |

**KIT RIPARAZIONE
REPAIRING KIT
KIT REPARATION
REPARATURSATZ
РЕМКОМПЛЕКТЫ
JUEGO DE REPARACION**

EMMERRE
spare parts for trucks and trailers

IVECO

| Applicazioni / Applications | Dettagli / Detail | Adattabile a / Adaptable to | Emmerre |
|--|---|-----------------------------|---|
| Eurocargo Eurocargo Tector Turbotech Turbostar | - Registro freno/ <i>Brake adjuster</i> <i>Meritor system</i> | 42480059 A2297L3158 | 963005 |
| | | |  |
| 175.17/24 Eurocargo Eurocargo Tector Turbotech Turbostar Eurotech | - Boccola zigrinata/ <i>Knurled bushing</i> <i>Meritor system</i> | 42480058 328058131 | 963006 |
| | | |  |
| 175.17/24 Eurocargo Eurocargo Tector Turbotech Turbostar Eurotech | - Astuccio/ <i>Holder</i> <i>Meritor system</i> | 42480060 3280Y8163 | 963007 |
| | | |  |
| 175.17/24 Eurocargo Eurocargo Tector Turbotech Turbostar Eurotech | - Kit riparazione completo/ <i>Complete repairing kit</i> <i>Meritor system</i> | 42491950 RBSK0502 | 963001 |
| | | |  |

Connessione / Connected:  963068-963069

I riferimenti indicati non sono originali ma perfettamente intercambiabili. I codici originali e le case costruttrici sono indicati a puro titolo informativo
The details described are not original but perfectly interchangeable. The original references and manufacturer names are given for information purposes only.

671

EMMERRE

spare parts for trucks and trailers

IVECO

KIT RIPARAZIONE
REPAIRING KIT
KIT REPARATION
REPARATURSATZ
РЕМКОМПЛЕКТЫ
JUEGO DE REPARACION

| Emmerre | Adattabile a / Adaptable to | Dettagli / Detail | Applicazioni / Applications |
|--|-------------------------------------|--|--|
| 963024  | 7980407 503472857 RBSK0250BM | - Kit cunei freno/ <i>Brake wedges kit</i> <i>Meritor system</i> | 175.17/24 Turbotech Turbostar |
| 963547  | 93161353 | - Kit cunei freno/ <i>Brake wedges kit</i> <i>Meritor system</i> | Eurocargo Eurocargo Tector Eurotech |
| 963023  | 7980406 503532557 RBSK0249B.M | - Kit pistone freno/ <i>Brake piston kit</i> - Destra/ <i>Right</i> <i>Meritor system</i> | 175.17/24 Eurocargo Eurocargo Tector Turbotech Turbostar Eurotech |
| 963022  | 7980405 503532558 RBSK0248B.M | - Kit pistone freno/ <i>Brake piston kit</i> - Sinistra/ <i>Left</i> <i>Meritor system</i> | 175.17/24 Eurocargo Eurocargo Tector Turbotech Turbostar Eurotech |

**KIT RIPARAZIONE
REPAIRING KIT
KIT REPARATION
REPARATURSATZ
РЕМКОМПЛЕКТЫ
JUEGO DE REPARACION**

EMMERRE
spare parts for trucks and trailers

IVECO

| Applicazioni / Applications | Dettagli / Detail | Adattabile a / Adaptable to | Emmerre |
|--|--|---|---------------|
| 175.17/24 Eurocargo Eurocargo Tector Turbotech Turbostar Eurotech | - Kit cuffie/Protective hoods set <u>Meritor system</u> | 7980408 RBSK0251B.M | 963025 |
| | |  | |
| 175.17/24 Eurocargo Eurocargo Tector Turbotech Turbostar Eurotech | - Kit molle ganasce/Shoes springs kit <u>Meritor system</u> | 7980687 RBSK03431B | 963026 |
| | |  | |
| 175.17/24 Eurocargo Eurocargo Tector Turbotech Turbostar Eurotech | - Kit riparazione freno ridotto/ Brake reduced kit <u>Meritor system</u> | 42491974 RBSK0549 | 963020 |
| | |  | |
| 175.17/24 Eurocargo Eurocargo Tector Turbotech Turbostar Eurotech | - Tubetto grasso/Grease <u>Meritor system</u> | 2992382 41817599 | 963013 |
| | |  | |

I riferimenti indicati non sono originali ma perfettamente intercambiabili. I codici originali e le case costruttrici sono indicati a puro titolo informativo
The details described are not original but perfectly interchangeable. The original references and manufacturer names are given for information purposes only.

| Emmerre | Adattabile a / Adaptable to | Dettagli / Detail | Applicazioni / Applications |
|---|-----------------------------|--|--|
| 963010 | 42480056 2258H580 | - Molla freno/Brake spring <i>Meritor system</i> | 175.17/24 Eurocargo Eurocargo Tector Turbotech Turbostar Eurotech |
|  | | | |
| 963011 | 42488736 1205B1666 | - Cuffia alta/High protective hood <i>Rockwell system</i> | 175.17/24 Eurocargo Eurocargo Tector Turbotech Turbostar Eurotech |
|  | | | |
| 963012 | 42488737 | - Cuffia bassa/Low protective hood <i>Meritor system</i> | 175.17/24 Eurocargo Eurocargo Tector Turbotech Turbostar Eurotech |
|  | | | |
| 963017 | 42480062 A2247U47 | - Dispositivo a cuneo/Device <i>Meritor system</i> | 175.17/24 Eurocargo Eurocargo Tector Turbotech Turbostar Eurotech |
|  | | | |

**KIT RIPARAZIONE
REPAIRING KIT
KIT REPARATION
REPARATURSATZ
РЕМКОМПЛЕКТЫ
JUEGO DE REPARACION**

EMMERRE
spare parts for trucks and trailers

IVECO

| Applicazioni / Applications | Dettagli / Detail | Adattabile a / Adaptable to | Emmerre |
|--|--|---------------------------------|---|
| 175.17/24 Eurocargo Eurocargo Tector Turbotech Turbostar Eurotech | - Stantuffo destro/ <i>Plunger right</i> <i>Meritor system</i> | 7984216 2980303 2297K4821 | 963014 |
| | | |  |
| 175.17/24 Eurocargo Eurocargo Tector Turbotech Turbostar Eurotech | - Stantuffo sinistro/ <i>Plunger left</i> <i>Meritor system</i> | 7984217 2980304 2297J4820 | 963015 |
| | | |  |
| 175.17/24 Eurocargo Eurocargo Tector Turbotech Turbostar Eurotech | - Molla/ <i>Spring</i> <i>Meritor system</i> | 42488484 2257M1001 | 963016 |
| | | |  |
| Eurocargo | - Set molle freno/ <i>Brake Springs set</i> <i>Meritor System</i> | 42538063 RBSK15611 | 960951 |
| | | |  |

Connessione / Connected:  963905-963906

I riferimenti indicati non sono originali ma perfettamente intercambiabili. I codici originali e le case costruttrici sono indicati a puro titolo informativo
The details described are not original but perfectly interchangeable. The original references and manufacturer names are given for information purposes only.



675

EMMERRE

spare parts for trucks and trailers

IVECO





KIT RIPARAZIONE REPAIRING KIT KIT REPARATION REPARATURSATZ РЕМКОМПЛЕКТЫ JUEGO DE REPARACION

| Emmerre | Adattabile a / Adaptable to | Dettagli / Detail | Applicazioni / Applications |
|--|-----------------------------|---|---|
| 960965  | 42538064 RBSK1558 | - Kit molle fissaggio ganasce/ <i>Fixing shoes spring kit</i> <i>Meritor System</i> | Eurocargo Tector |
| Connessione / Connected: | | |  963905-963906 |
| 960511  | 42537942 RBSK1255M | - Kit cunei freno/ <i>Brake wedges kit</i> <i>Meritor System</i> | Eurocargo |
| Connessione / Connected: | | |  963905-963906 |
| 960603  | 42538066 RBSK15571 | - Kit revisione freni/ <i>Brake overhaul kit</i> <i>Meritor System</i> | Eurocargo |
| Connessione / Connected: | | |  963905-963906 |
| 960601  | 42538062 RBSK1563 | - Kit revisione freni/ <i>Brake overhaul kit</i> <i>Meritor System</i> | Eurocargo |
| Connessione / Connected: | | |  963905-963906 |

**KIT RIPARAZIONE
REPAIRING KIT
KIT REPARATION
REPARATURSATZ
РЕМКОМПЛЕКТЫ
JUEGO DE REPARACION**

EMMERRE
spare parts for trucks and trailers

IVECO

| Applicazioni / Applications | Dettagli / Detail | Adattabile a / Adaptable to | Emmerre |
|--|--|-----------------------------|---------------|
| Eurotech Eurotech Cursor Eurotrakker Eurotrakker Cursor | - Cuffia/Protective hood <u>Meritor System</u> | 42531677 1205X2000 | 963541 |
|  | | | |
| Eurotech Eurotech Cursor Eurotrakker Eurotrakker Cursor | - Kit cuffie/Protective hoods set <u>Meritor System</u> | 93161625 RBSK2030M | 963535 |
|  | | | |
| Eurocargo Eurocargo Tector | - Kit riparazione freni/Brake repairing kit <u>Meritor system</u> | 42538065 RBSK1560 | 963904 |
|  | | | |
| Connessione / Connected:  963905-963906 | | | |
| Eurotech Eurotech Cursor Eurotrakker Eurotrakker Cursor Stralis | - Kit cunei freno/Brake wedges kit <u>Perrot system</u> | 93161768 12999410VT | 963553 |
|  | | | |





I riferimenti indicati non sono originali ma perfettamente intercambiabili. I codici originali e le case costruttrici sono indicati a puro titolo informativo
The details described are not original but perfectly interchangeable. The original references and manufacturer names are given for information purposes only.

EMMERRE

spare parts for trucks and trailers

IVECO

KIT RIPARAZIONE
REPAIRING KIT
KIT REPARATION
REPARATURSATZ
РЕМКОМПЛЕКТЫ
JUEGO DE REPARACION

| Emmerre | Adattabile a / Adaptable to | Dettagli / Detail | Applicazioni / Applications |
|---|--|---|---|
| 963555 | 93161872 12999573VT | - Set molle freno/ <i>Brake Springs set</i> <i>Perrot system</i> | Eurotech Eurotech Cursor Eurostar Eurotrakker Eurotrakker Cursor Stralis |
|  | | | |
| 963548 | 93161256 12999411VT | - Kit revisione boccole freno/ <i>Overhaul kit for brake bush</i> <i>Perrot system</i> | Eurotech Eurotech Cursor Eurotrakker Eurotrakker Cursor Stralis |
|  | | | |
| 963125 | 500054820 2996557 | - Kit riparazione freni/ <i>Brake Repairing kit</i> <i>Meritor system</i> | Eurotech Eurotech Cursor Eurostar Eurotrakker Eurotrakker Cursor |
|  | | | |
| 963533 | 42558430 93162114 93161622 RBSK1408 | - Kit riparazione freno/ <i>Brake repair kit</i> <i>Meritor System</i> | Eurotech Eurotech Cursor Eurotrakker Eurotrakker Cursor |
|  | | | |

Connessione / Connected:  963456-963457-963551-963552

**KIT RIPARAZIONE
REPAIRING KIT
KIT REPARATION
REPARATURSATZ
РЕМКОМПЛЕКТЫ
JUEGO DE REPARACION**

EMMERRE
spare parts for trucks and trailers

IVECO

| Applicazioni / Applications | Dettagli / Detail | Adattabile a / Adaptable to | Emmerre |
|---|---|-----------------------------------|---------------|
| Eurotech Eurotech Cursor Eurotrakker Eurotrakker Cursor | - Kit cunei freno/Brake wedges kit <i>Meritor System</i> | 93161621 RBSK2051M | 963536 |
|  | | | |
| Eurotech Eurotech Cursor Eurotrakker Eurotrakker Cursor | - Kit perni freno sinistro/Brake pins set left <i>Meritor System</i> | 93161863 RBSK1481M | 963537 |
|  | | | |
| Eurotech Eurotech Cursor Eurotrakker Eurotrakker Cursor | - Kit perni freno destro/Brake pins set right <i>Meritor System</i> | 93161864 RBSK1482M | 963538 |
|  | | | |
| Eurotech Eurotech Cursor Eurotrakker Eurotrakker Cursor | - Set molle/Spring set <i>Meritor System</i> | 93162113 93161627 RBSK2128M | 963539 |
|  | | | |

I riferimenti indicati non sono originali ma perfettamente intercambiabili. I codici originali e le case costruttrici sono indicati a puro titolo informativo
The details described are not original but perfectly interchangeable. The original references and manufacturer names are given for information purposes only.

EMMERRE

spare parts for trucks and trailers

IVECO





KIT RIPARAZIONE
REPAIRING KIT
KIT REPARATION
REPARATURSATZ
РЕМКОМПЛЕКТЫ
JUEGO DE REPARACION

| Emmerre | Adattabile a / <i>Adaptable to</i> | Dettagli / <i>Detail</i> | Applicazioni / <i>Applications</i> |
|--|------------------------------------|--|---|
| 963534  | 42558429 93161623 RBSK1407 | - Kit riparazione freno ridotto/ <i>Brake reduced kit</i> <i>Meritor System</i> | Eurotech Eurotech Cursor Eurotrakker Eurotrakker Cursor |
| 963009  | 42531676 A22297E5909 | - Dispositivo registro freno/ <i>Brake adjuster device</i> <i>Meritor System</i> | Eurotech Eurotech Cursor Eurotrakker Eurotrakker Cursor |
| 963540  | 93161626 RBSK1409 | - Kit fissaggio ganasce freno/ <i>Brake shoes fixing kit</i> <i>Meritor system</i> | Eurotrakker Eurotrakker Cursor Bus Euroclass Euro rider Turbocity |
| 963027  | 42536176 1205Y2001 | - Cuffia bassa/ <i>Low protective hood</i> <i>Meritor System</i> | Eurotrakker Cursor |

**KIT RIPARAZIONE
REPAIRING KIT
KIT REPARATION
REPARATURSATZ
РЕМКОМПЛЕКТЫ
JUEGO DE REPARACION**

EMMERRE
spare parts for trucks and trailers

IVECO

| Applicazioni / Applications | Dettagli / Detail | Adattabile a / Adaptable to | Emmerre |
|--|--|---|---------------|
| Eurotrakker Eurotrakker Cursor Bus Euroclass Eurorider TurboCity | - Set molle freno/ <i>Brake Springs set</i> <i>Meritor system</i> | 42536192 RBSK1586M | 963560 |
| | |  | |
| Eurotech Eurotech Cursor Eurotrakker Eurotrakker Cursor | - Supporto massa freno/ <i>Brake wheel support</i> - Simplex <i>Meritor System</i> | 93192915 3211Q498335 | 963532 |
| | |  | |
| Connessione / Connected:  963456-963457-963551-963552 | | | |
| Eurotrakker Eurotrakker Cursor Stralis Bus Euroclass Eurorider TurboCity | - Kit riparazione freno/ <i>Brake repairing kit</i> <i>Meritor system</i> | 42536197 42558432 RBSK2301 | 963594 |
| | |  | |
| Eurotrakker Eurotrakker Cursor Stralis Bus Euroclass Eurorider TurboCity | - Kit riparazione freno ridotto/ <i>Brake reduced kit</i> <i>Meritor system</i> | 42558431 42536195 | 963596 |
| | |  | |





I riferimenti indicati non sono originali ma perfettamente intercambiabili. I codici originali e le case costruttrici sono indicati a puro titolo informativo
The details described are not original but perfectly interchangeable. The original references and manufacturer names are given for information purposes only.

EMMERRE

spare parts for trucks and trailers

IVECO





KIT RIPARAZIONE REPAIRING KIT KIT REPARATION REPARATURSATZ РЕМКОМПЛЕКТЫ JUEGO DE REPARACION

| Emmerre | Adattabile a / Adaptable to | Dettagli / Detail | Applicazioni / Applications |
|--|-----------------------------|---|---|
| 963595  | 42537365 RBSK1606.M | - Parte fissa/Fixed part - Lato destro/Right side <i>Meritor system</i> | Eurotrakker Eurotrakker Cursor Stralis Bus Euroclass Eurorider Turbocity |
| 963569  | 42537366 RBSK1607M | - Kit riparazione/repairing kit - Parte fissa/Fixed part - Lato sinistro/Left side <i>Meritor system</i> | Eurotrakker Eurotrakker Cursor Stralis Bus Euroclass Eurorider Turbocity |
| 963574  | 42537884 RBSK16251 | - Kit cuffie/Protective hoods set <i>Meritor system</i> | Eurotrakker Eurotrakker Cursor Stralis Bus Euroclass Eurorider Turbocity |
| 963575  | 42537758 A229758287 | - Dispositivo registro freno/ Brake adjuster device <i>Meritor system</i> | Eurotrakker Eurotrakker Cursor Bus Euroclass Eurorider Turbocity |

**KIT RIPARAZIONE
REPAIRING KIT
KIT REPARATION
REPARATURSATZ
РЕМКОМПЛЕКТЫ
JUEGO DE REPARACION**

EMMERRE
spare parts for trucks and trailers

IVECO

| Applicazioni / Applications | Dettagli / Detail | Adattabile a / Adaptable to | Emmerre |
|--|--|-----------------------------|---------------|
| Eurotrakker Eurotrakker Cursor Stralis Bus Euroclass Eurorider Turbocity | - Kit cunei freno/ <i>Brake wedges kit</i> <i>Meritor system</i> | 42536194 RBSK1573M | 963593 |
|  | | | |
| Eurotrakker Eurotrakker Cursor Trakker | - Supporto gruppo freno/ <i>Brake assembly support</i> - Duplex <i>Meritor system</i> | 42536143 3211P675035 | 963131 |
|  | | | |
| Connessione / Connected:  963570-963571 | | | |
| Eurotrakker Eurotrakker Cursor Bus Euroclass Eurorider Turbocity | - Cuffia bassa/ <i>Low protective hood</i> <i>Meritor system</i> | 42537841 1205E2683 | 963576 |
|  | | | |
| Eurotrakker Eurotrakker Cursor Stralis | - Kit riparazione/ <i>Repairing kit</i> - Parte fissa/ <i>Fixed part</i> - Lato destro/ <i>Right side</i> <i>Meritor system</i> | 42537363 RBSK1599M | 963465 |
|  | | | |

I riferimenti indicati non sono originali ma perfettamente intercambiabili. I codici originali e le case costruttrici sono indicati a puro titolo informativo
The details described are not original but perfectly interchangeable. The original references and manufacturer names are given for information purposes only.

EMMERRE

spare parts for trucks and trailers

IVECO

KIT RIPARAZIONE REPAIRING KIT KIT REPARATION REPARATURSATZ РЕМКОМПЛЕКТЫ JUEGO DE REPARACION

| Emmerre | Adattabile a / Adaptable to | Dettagli / Detail | Applicazioni / Applications |
|---|-----------------------------|--|---|
| 963466 | 42537364 RBSK1600M | - Kit riparazione/Repairing kit - Parte fissa/Fixed part - Lato sinistro/Left side <i>Meritor system</i> | Eurotrakker Eurotrakker Cursor Stralis |
|  | | | |
| 963627 | 42536177 RBSK15841 | - Kit riparazione/Repairing kit - Per freno ruota completo/ For complete wheel brake - Destra/Right <i>Meritor system</i> | Eurotrakker Cursor |
|  | | | |
| 963626 | 42536178 RBSK15851 | - Kit riparazione/repairing kit - Per freno ruota completo/ For complete wheel brake - Sinistra/Left <i>Meritor system</i> | Eurotrakker Cursor |
|  | | | |
| 963625 | 42536193 RBSK20311 | - Kit cuffie/protective hoods set <i>Meritor system</i> | Eurotrakker Cursor |
|  | | | |

**KIT RIPARAZIONE
REPAIRING KIT
KIT REPARATION
REPARATURSATZ
РЕМКОМПЛЕКТЫ
JUEGO DE REPARACION**

EMMERRE
spare parts for trucks and trailers

IVECO

| Applicazioni / Applications | Dettagli / Detail | Adattabile a / Adaptable to | Emmerre |
|---|---|----------------------------------|---------------|
| Eurotrakker Cursor | <ul style="list-style-type: none"> - Kit riparazione/repairing kit - Per una ruota/For one wheel - Rinforzato/Reinforced <p><u>Meritor system</u></p> | 42562830 42559512 | 963583 |
| Eurotrakker Cursor | <ul style="list-style-type: none"> - Kit riparazione/repairing kit - Per due ruote/For two wheels - Rinforzato/Reinforced <p><u>Meritor system</u></p> | 42558433 42559513 42550961 | 963624 |
| Eurotrakker Eurotrakker Cursor | <ul style="list-style-type: none"> - Set molle freno/Brake Springs set <p><u>Meritor system</u></p> | 42550957 | 963518 |
| Eurotrakker Eurotrakker Cursor Trakker | <ul style="list-style-type: none"> - Kit riparazione/Repairing kit - Parte fissa/Fixed part - Lato destro/Right side <p><u>Meritor system</u></p> | 42536200 RBSK15951 | 963467 |









| Emmerre | Adattabile a / Adaptable to | Dettagli / Detail | Applicazioni / Applications |
|--|-----------------------------|---|---|
| 963468  | 42536201 RBSK15961 | - Kit riparazione/Repairing kit - Parte fissa/Fixed part - Lato sinistro/Left side <u>Meritor system</u> | Eurotrakker Eurotrakker Cursor Trakker |
| 963004  | 42488208 12999063VT | - Kit cuffie alte e basse/ High and low Protective hoods set <u>Perrot system</u> | Bus Euroclass Euro rider Turbocity |
| 963127  | 93163356 | - Coperchio parapolvere/Cover | Eurotech Eurostar Eurotrakker |
| | | Connessione / Connected:  | 41025327-41025328 |
| 963630  | 93161624 | - Kit riparazione/Repairing kit <u>Meritor system</u> | Eurotech Eurotrakker |

**KIT RIPARAZIONE
REPAIRING KIT
KIT REPARATION
REPARATURSATZ
РЕМКОМПЛЕКТЫ
JUEGO DE REPARACION**

EMMERRE
spare parts for trucks and trailers

IVECO

| Applicazioni / Applications | Dettagli / Detail | Adattabile a / Adaptable to | Emmerre |
|---|--|---|---------------|
| Turbotech Turbostar 330 | - Tassello in gomma rettangolare/ <i>Rectangular rubber plug</i> <i>Meritor system</i> | 42493640 503476067 | 103647 |
| | |  | |
| Turbotech Turbostar Eurotech | - Tassello in gomma rotondo/ <i>Round rubber plug</i> <i>Meritor system</i> | 42480064 93156906 | 103648 |
| | |  | |
| Daily Restyling New Daily Turbodaily | - Registro completo automatico/ <i>Complete auto adjuster</i> - Destra/ <i>Right</i> | -- | 960844 |
| | |  | |
| Connessione / Connected:  963087-963097-963115 | | | |
| Daily Restyling New Daily Turbodaily | - Registro completo automatico/ <i>Complete auto adjuster</i> - Sinistra/ <i>Left</i> | -- | 960845 |
| | |  | |
| Connessione / Connected:  963086-963098-963114 | | | |

I riferimenti indicati non sono originali ma perfettamente intercambiabili. I codici originali e le case costruttrici sono indicati a puro titolo informativo
The details described are not original but perfectly interchangeable. The original references and manufacturer names are given for information purposes only.

| Emmerre | Adattabile a / Adaptable to | Dettagli / Detail | Applicazioni / Applications |
|---------------|----------------------------------|--|---|
| 960860 | 93192155 8190358 503474998 | - Registro freno automatico/ <i>Automatic Brake adjuster</i> | Daily Restyling New Daily Turbodaily |
| | | | Connessione / Connected:  962288 |
| 960859 | 4851782 8198934 | - Registro freno automatico/ <i>Automatic Brake adjuster</i> | Daily Zeta Turbozeta |
| 960855 | 8528686 3475296 | - Registro freno/ <i>Brake adjuster</i> | 50NC 50-55-65-70-75F8 619N1 697-300 OM 40 |
| 960856 | -- | - Registro freno/ <i>Brake adjuster</i> - Con molla/ <i>With spring</i> | 50NC 50-55-65-70-75F8 619N1 697-300 |



**KIT RIPARAZIONE
REPAIRING KIT
KIT REPARATION
REPARATURSATZ
РЕМКОМПЛЕКТЫ
JUEGO DE REPARACION**

EMMERRE
spare parts for trucks and trailers

IVECO

| Applicazioni / Applications | Dettagli / Detail | Adattabile a / Adaptable to | Emmerre |
|-----------------------------|---|-----------------------------|---------------|
| Turbozeta Zeta | - Registro freno automatico/ <i>Automatic Brake adjuster</i> | 7170420 7164657 | 960857 |



| | | | |
|-------------------|---|--------------------|---------------|
| Turbozeta Zeta | - Registro freno automatico/ <i>Automatic Brake adjuster</i> | 4819706 7165279 | 960840 |
|-------------------|---|--------------------|---------------|



| | | | |
|-----------------------------|---|----|---------------|
| 645 650 662 110 NC | - Piastra freno completa/ <i>Complete brake plate</i> - Anteriore/ <i>Front</i> | -- | 960330 |
|-----------------------------|---|----|---------------|



| | | | |
|-----------|---|----------|---------------|
| Eurocargo | - Registro freni a tamburo/ <i>Brake drum adjuster</i> | 93163525 | 960590 |
|-----------|---|----------|---------------|



I riferimenti indicati non sono originali ma perfettamente intercambiabili. I codici originali e le case costruttrici sono indicati a puro titolo informativo
The details described are not original but perfectly interchangeable. The original references and manufacturer names are given for information purposes only.

| Emmerre | Adattabile a / Adaptable to | Dettagli / Detail | Applicazioni / Applications |
|---|-----------------------------|---|---|
| 962501 | 42064491 | - Ghiera cilindro freno/ <i>Brake cylinder ring nut</i> - M48 x 2 | Eurocargo Tector |
|  | | | |
| 962505 | 93163852 | - Ghiera cilindro freno/ <i>Brake cylinder ring nut</i> - M48 x 2 | Eurostar Eurotrakker Cursor Stralis |
|  | | | |
| 962504 | 4756032 1227L1156 | - Ghiera cilindro freno/ <i>Brake cylinder ring nut</i> - 1" 3/4 | Turbostar |
|  | | | |
| 963028 | 42063178 42062522 | - Ghiera cilindro freno/ <i>Brake cylinder ring nut</i> - 1" 3/4 | Turbostar 330 135.17 |
|  | | | |

**KIT RIPARAZIONE
REPAIRING KIT
KIT REPARATION
REPARATURSATZ
РЕМКОМПЛЕКТЫ
JUEGO DE REPARACION**

EMMERRE
spare parts for trucks and trailers

IVECO

| Applicazioni / Applications | Dettagli / Detail | Adattabile a / Adaptable to | Emmerre |
|-----------------------------|--|----------------------------------|---|
| Eurotrakker Cursor | - Ghiera corta cilindro freno/ <i>Short Brake cylinder ring nut</i> - M48 x 2 | 41211047 | 963067 |
| | | |  |
| All trucks | - Membrana corta tipo/ <i>Membrane short type 9"</i> - Ø mm. 128 x 30 - Battuta/Stroke mm.44 | 8123746 1257928 8971204954 | 970801 |
| | | |  |
| All trucks | - Membrana corta tipo/ <i>Membrane short type 12"</i> - Ø mm. 139 x 29 - Battuta/Stroke mm.44 | 9986597 | 970802 |
| | | |  |
| All trucks | - Membrana corta tipo/ <i>Membrane short type 16"</i> - Ø mm. 158 x 36 - Battuta/Stroke mm.57 | 2961819 8971205104 | 970803 |
| | | |  |

I riferimenti indicati non sono originali ma perfettamente intercambiabili. I codici originali e le case costruttrici sono indicati a puro titolo informativo
The details described are not original but perfectly interchangeable. The original references and manufacturer names are given for information purposes only.

| Emmerre | Adattabile a / Adaptable to | Dettagli / Detail | Applicazioni / Applications |
|---|-----------------------------------|---|-----------------------------|
| 970804 | 1282538 8971205204 | - Membrana corta tipo/ <i>Membrane short type 20"</i> - Ø mm. 168 x 38 - Battuta/ <i>Stroke</i> mm.57 | All trucks |
|  | | | |
| 970805 | 1271506 8971205304 | - Membrana corta tipo/ <i>Membrane short type 24"</i> - Ø mm. 178 x 42 - Battuta/ <i>Stroke</i> mm.64 | All trucks |
|  | | | |
| 970806 | 8971205404 | - Membrana corta tipo/ <i>Membrane short type 30"</i> - Ø mm. 201 x 36 - Battuta/ <i>Stroke</i> mm.64 | All trucks |
|  | | | |
| 970808 | 8197157 42487115 8971205054 | - Membrana media tipo/ <i>Membrane medium type 12"</i> - Ø mm. 139 x 50 - Battuta/ <i>Stroke</i> mm.70 | All trucks |
|  | | | |

**KIT RIPARAZIONE
REPAIRING KIT
KIT REPARATION
REPARATURSATZ
РЕМКОМПЛЕКТЫ
JUEGO DE REPARACION**

EMMERRE
spare parts for trucks and trailers

IVECO

| Applicazioni / Applications | Dettagli / Detail | Adattabile a / Adaptable to | Emmerre |
|-----------------------------|---|-----------------------------|---|
| All trucks | - Membrana lunga tipo/ <i>Membrane long type 16"</i> - Ø mm. 158 x 58 - Battuta/Stroke mm.44 | 8971205164 | 970809 |
| | | |  |
| All trucks | - Membrana lunga tipo/ <i>Membrane long type 20"</i> - Ø mm. 168 x 50 - Battuta/Stroke mm.76 | 8971205264 | 970810 |
| | | |  |
| All trucks | - Membrana lunga tipo/ <i>Membrane long type 24"</i> - Ø mm. 178 x 52 - Battuta/Stroke mm.76 | 8971205364 | 970811 |
| | | |  |
| All trucks | - Membrana lunga tipo/ <i>Membrane long type 30"</i> - Ø mm. 203 x 52 - Battuta/Stroke mm.76 | 8971205464 | 970812 |
| | | |  |

I riferimenti indicati non sono originali ma perfettamente intercambiabili. I codici originali e le case costruttrici sono indicati a puro titolo informativo
The details described are not original but perfectly interchangeable. The original references and manufacturer names are given for information purposes only.

693

| Emmerre | Adattabile a / <i>Adaptable to</i> | Dettagli / <i>Detail</i> | Applicazioni / <i>Applications</i> |
|---|------------------------------------|---|------------------------------------|
| 963532 | 1474276 | - Supporto massa freno/ <i>Brake wheel support</i> - Simplex | All trucks |
|  | | | |
| 963541 | 8600569 | - Cuffia/ <i>Protective hood</i> | All trucks |
|  | | | |
| 963537 | 2020376 | - Kit perni freno/ <i>Brake pins set</i> - Sinistra/ <i>Left</i> | All trucks |
|  | | | |
| 963538 | 2020382 | - Kit perni freno/ <i>Brake pins set</i> - Destra/ <i>Right</i> | All trucks |
|  | | | |

**KIT RIPARAZIONE
REPAIRING KIT
KIT REPARATION
REPARATURSATZ
РЕМКОМПЛЕКТЫ
JUEGO DE REPARACION**

EMMERRE
spare parts for trucks and trailers

MAN

| Applicazioni / Applications | Dettagli / Detail | Adattabile a / Adaptable to | Emmerre |
|-----------------------------|--|-----------------------------|---|
| All trucks | - Ghiera cilindro freno/ <i>Brake cylinder ring nut</i> - 1' 3/4 | 1449702 | 962504 |
| | | |  |
| All trucks | - Membrana corta tipo/ <i>Membrane short type 16"</i> - Ø mm. 158 x 36 - Battuta/Stroke mm.57 | 81511130013 | 970803 |
| | | |  |
| All trucks | - Membrana corta tipo/ <i>Membrane short type 20"</i> - Ø mm. 168 x 38 - Battuta/Stroke mm.57 | 81511130001 | 970804 |
| | | |  |
| All trucks | - Membrana corta tipo/ <i>Membrane short type 24"</i> - Ø mm. 178 x 42 - Battuta/Stroke mm.64 | 81521120039 81511130002 | 970805 |
| | | |  |

I riferimenti indicati non sono originali ma perfettamente intercambiabili. I codici originali e le case costruttrici sono indicati a puro titolo informativo
The details described are not original but perfectly interchangeable. The original references and manufacturer names are given for information purposes only.

| Emmerre | Adattabile a / Adaptable to | Dettagli / Detail | Applicazioni / Applications |
|---|-----------------------------|---|-----------------------------|
| 970806 | 90911590013 | - Membrana corta tipo/ <i>Membrane short type 30"</i> - Ø mm. 201 x 36 - Battuta/ <i>Stroke</i> mm.64 | All trucks |
|  | | | |
| 970808 | 99014360821 81511130019 | - Membrana media tipo/ <i>Membrane medium type 12"</i> - Ø mm. 139 x 50 - Battuta/ <i>Stroke</i> mm.70 | All trucks |
|  | | | |
| 970809 | 81511130007 | - Membrana lunga tipo/ <i>Membrane long type 16"</i> - Ø mm. 158 x 58 - Battuta/ <i>Stroke</i> mm.44 | All trucks |
|  | | | |
| 970810 | 81511130020 | - Membrana lunga tipo/ <i>Membrane long type 20"</i> - Ø mm. 168 x 50 - Battuta/ <i>Stroke</i> mm.76 | All trucks |
|  | | | |





**KIT RIPARAZIONE
REPAIRING KIT
KIT REPARATION
REPARATURSATZ
РЕМКОМПЛЕКТЫ
JUEGO DE REPARACION**

EMMERRE
spare parts for trucks and trailers

MAN

| Applicazioni / Applications | Dettagli / Detail | Adattabile a / Adaptable to | Emmerre |
|-----------------------------|---|-----------------------------|---------------|
| All trucks | <ul style="list-style-type: none">- Membrana lunga tipo/ <i>Membrane long type 24"</i>- Ø mm. 178 x 52- Battuta/<i>Stroke</i> mm.76 | 81511130017 | 970811 |
| | | | |
| | | | |
| | | | |







| Emmerre | Adattabile a / <i>Adaptable to</i> | Dettagli / <i>Detail</i> | Applicazioni / <i>Applications</i> |
|---|------------------------------------|--|------------------------------------|
| 963574 | 6394200220 | - Kit Cuffie/ <i>Protective Hoods kit</i> <i>Meritor System</i> | Viano Vito |
|  | | | |
| 970801 | 0001440028 | - Membrana corta tipo/ <i>Membrane short type 9"</i> - Ø mm. 128 x 30 - Battuta/ <i>Stroke</i> mm.44 | All trucks |
|  | | | |
| 970803 | 0004212986 | - Membrana corta tipo/ <i>Membrane short type 16"</i> - Ø mm. 158 x 36 - Battuta/ <i>Stroke</i> mm.57 | All trucks |
|  | | | |
| 970804 | 0004310728 8971205204 | - Membrana corta tipo/ <i>Membrane short type 20"</i> - Ø mm. 168 x 38 - Battuta/ <i>Stroke</i> mm.57 | All trucks |
|  | | | |

KIT RIPARAZIONE
REPAIRING KIT
KIT REPARATION
REPARATURSATZ
РЕМКОМПЛЕКТЫ
JUEGO DE REPARACION

EMMERRE
spare parts for trucks and trailers

MERCEDES

| Applicazioni / Applications | Dettagli / Detail | Adattabile a / Adaptable to | Emmerre |
|-----------------------------|---|-----------------------------|---|
| All trucks | - Membrana corta tipo/ <i>Membrane short type 24"</i> - Ø mm. 178 x 42 - Battuta/Stroke mm.64 | 0004212086 | 970805 |
| | | |  |
| All trucks | - Membrana corta tipo/ <i>Membrane short type 30"</i> - Ø mm. 201 x 36 - Battuta/Stroke mm.64 | 0004231286 | 970806 |
| | | |  |
| All trucks | - Membrana media tipo/ <i>Membrane medium type 12"</i> - Ø mm. 139 x 50 - Battuta/Stroke mm.70 | 0004311728 | 970808 |
| | | |  |
| All trucks | - Membrana lunga tipo/ <i>Membrane long type 16"</i> - Ø mm. 158 x 58 - Battuta/Stroke mm.44 | 0004312026 | 970809 |
| | | |  |

I riferimenti indicati non sono originali ma perfettamente intercambiabili. I codici originali e le case costruttrici sono indicati a puro titolo informativo
The details described are not original but perfectly interchangeable. The original references and manufacturer names are given for information purposes only.

699

| Emmerre | Adattabile a / <i>Adaptable to</i> | Dettagli / <i>Detail</i> | Applicazioni / <i>Applications</i> |
|---|------------------------------------|---|------------------------------------|
| 970810 | 0004214286 0004230096 | - Membrana lunga tipo/ <i>Membrane long type 20"</i> - Ø mm. 168 x 50 - Battuta/ <i>Stroke</i> mm.76 | All trucks |
|  | | | |
| 970811 | 0004311928 | - Membrana lunga tipo/ <i>Membrane long type 24"</i> - Ø mm. 178 x 52 - Battuta/ <i>Stroke</i> mm.76 | All trucks |
|  | | | |
| 970812 | 0004216286 | - Membrana lunga tipo/ <i>Membrane long type 30"</i> - Ø mm. 203 x 52 - Battuta/ <i>Stroke</i> mm.76 | All trucks |
|  | | | |

KIT RIPARAZIONE
REPAIRING KIT
KIT REPARATION
REPARATURSATZ
РЕМКОМПЛЕКТЫ
JUEGO DE REPARACION

EMMERRE
spare parts for trucks and trailers

NISSAN

| Applicazioni / Applications | Dettagli / Detail | Adattabile a / Adaptable to | Emmerre |
|-----------------------------|--------------------------|-----------------------------|---------------|
| All trucks | - Cuffia/Protective hood | 069028590 | 963541 |



| Emmerre | Adattabile a / <i>Adaptable to</i> | Dettagli / <i>Detail</i> | Applicazioni / <i>Applications</i> |
|---|------------------------------------|---|------------------------------------|
| 962098 | 5010098945 503529934 | - Molla freno posteriore/ <i>Rear brake spring</i> | Magnum Premium AE |
|  | | | |
| 962099 | 5010097340 503470050 | - Molla freno posteriore/ <i>Rear brake spring</i> | Magnum Premium AE |
|  | | | |
| 962100 | 5010097089 503469909 | - Molla freno posteriore/ <i>Rear brake spring</i> | Magnum Premium AE |
|  | | | |
| 963019 | 5021170485 | - Kit cilindri freno/ <i>Brake cylinder kit</i> <i>Perrot system</i> | All trucks |
|  | | | |

KIT RIPARAZIONE
REPAIRING KIT
KIT REPARATION
REPARATURSATZ
РЕМКОМПЛЕКТЫ
JUEGO DE REPARACION

EMMERRE
spare parts for trucks and trailers

RENAULT

| Applicazioni / Applications | Dettagli / Detail | Adattabile a / Adaptable to | Emmerre |
|-----------------------------|--|-----------------------------|---|
| All trucks | - Membrana corta tipo/ <i>Membrane short type 9"</i> - Ø mm. 128 x 30 - Battuta/Stroke mm.44 | 5001832026 5021170272 | 970801 |
| | | |  |
| All trucks | - Membrana corta tipo/ <i>Membrane short type 16"</i> - Ø mm. 158 x 36 - Battuta/Stroke mm.57 | 5021170274 5000821928 | 970803 |
| | | |  |
| All trucks | - Membrana corta tipo/ <i>Membrane short type 20"</i> - Ø mm. 168 x 38 - Battuta/Stroke mm.57 | 5000243913 5021170276 | 970804 |
| | | |  |
| All trucks | - Membrana corta tipo/ <i>Membrane short type 24"</i> - Ø mm. 178 x 42 - Battuta/Stroke mm.64 | 5000243917 | 970805 |
| | | |  |

| Emmerre | Adattabile a / Adaptable to | Dettagli / Detail | Applicazioni / Applications |
|---|-----------------------------|---|-----------------------------|
| 970806 | 7701005197 5021170282 | - Membrana corta tipo/ <i>Membrane short type 30"</i> - Ø mm. 201 x 36 - Battuta/ <i>Stroke</i> mm.64 | All trucks |
|  | | | |
| 970808 | 5000814337 5000130329 | - Membrana media tipo/ <i>Membrane medium type 12"</i> - Ø mm. 139 x 50 - Battuta/ <i>Stroke</i> mm.70 | All trucks |
|  | | | |
| 970810 | 5000819262 5021170278 | - Membrana lunga tipo/ <i>Membrane long type 20"</i> - Ø mm. 168 x 50 - Battuta/ <i>Stroke</i> mm.76 | All trucks |
|  | | | |
| 970811 | 5000809652 5021170284 | - Membrana lunga tipo/ <i>Membrane long type 24"</i> - Ø mm. 178 x 52 - Battuta/ <i>Stroke</i> mm.76 | All trucks |
|  | | | |

KIT RIPARAZIONE
REPAIRING KIT
KIT REPARATION
REPARATURSATZ
РЕМКОМПЛЕКТЫ
JUEGO DE REPARACION

EMMERRE
spare parts for trucks and trailers

RENAULT

| Applicazioni / Applications | Dettagli / Detail | Adattabile a / Adaptable to | Emmerre |
|-----------------------------|---|---|---------------|
| All trucks | - Membrana lunga tipo/ <i>Membrane long type 30"</i> - Ø mm. 203 x 52 - Battuta/Stroke mm.76 | 5000807176 5021170283 | 970812 |
| | |  | |
| Midliner Midlum | - Registro freni a tamburo/ <i>Brake drum adjuster</i> | 5000815484 | 960591 |
| | |  | |
| Kerax Premium | - Cuffia/Protective hood Z-Cam | 5001868119 | 963604 |
| | |  | |
| Kerax Premium | - Perno/Pin Z-Cam | 5001868121 | 963606 |
| | |  | |

I riferimenti indicati non sono originali ma perfettamente intercambiabili. I codici originali e le case costruttrici sono indicati a puro titolo informativo
The details described are not original but perfectly interchangeable. The original references and manufacturer names are given for information purposes only.

| Emmerre | Adattabile a / <i>Adaptable to</i> | Dettagli / <i>Detail</i> | Applicazioni / <i>Applications</i> |
|---|------------------------------------|--|------------------------------------|
| 963607 | 5001868120 | - Perno/ <i>Pin Z-Cam</i> | Kerax Premium |
|  | | | |
| 963610 | 5001868125 | - Pignone registro/ <i>Adjuster pinion Z-Cam</i> - Sinistra/ <i>Left</i> | Kerax Premium |
|  | | | |
| 963611 | 5001868126 | - Pignone registro/ <i>Adjuster pinion Z-Cam</i> - Destra/ <i>Right</i> | Kerax Premium |
|  | | | |
| 963584 | 5001868117 ST4013 | - Dispositivo registro/ <i>Adjuster device Z-Cam</i> - Destra/ <i>Right</i> | Kerax Premium |
|  | | | |

KIT RIPARAZIONE
REPAIRING KIT
KIT REPARATION
REPARATURSATZ
РЕМКОМПЛЕКТЫ
JUEGO DE REPARACION

EMMERRE
spare parts for trucks and trailers

RENAULT

| Applicazioni / Applications | Dettagli / Detail | Adattabile a / Adaptable to | Emmerre |
|-----------------------------|---|---|---------------|
| Kerax Premium | - Dispositivo registro/ <i>Adjuster device</i> Z-Cam - Sinistra/ <i>Left</i> | 5001868118 ST4014 | 963585 |
| | |  | |
| Kerax Premium | - Kit revisione/ <i>Overhaul kit</i> - Sinistra/ <i>Left</i> - Z-Cam | 7400276097 | 963586 |
| | |  | |
| Kerax Premium | - Kit revisione/ <i>Overhaul kit</i> - Destra/ <i>Right</i> - Z-Cam | 7400276098 | 963587 |
| | |  | |
| Kerax Premium | - Kit revisione/ <i>Overhaul kit</i> - Z-Cam | 7403090964 | 963612 |
| | |  | |

I riferimenti indicati non sono originali ma perfettamente intercambiabili. I codici originali e le case costruttrici sono indicati a puro titolo informativo
The details described are not original but perfectly interchangeable. The original references and manufacturer names are given for information purposes only.

| Emmerre | Adattabile a / Adaptable to | Dettagli / Detail | Applicazioni / Applications |
|---|-----------------------------|--|-----------------------------|
| 963021 | 12999134VT | - Kit registro cunei freno/ <i>Brake adjuster wedges kit</i> <i>Perrot System</i> | Axle |
|  | | | |
| 963003 | 12999135VT | - Kit revisione cuscinetti/ <i>Bearings Overhaul kit</i> - Ø mm. 36 x 18 <i>Perrot System</i> | Axle |
|  | | | |
| 963002 | 12999011VT | - Kit cuffie/Protective hoods set <i>Perrot System</i> | Axle |
|  | | | |
| 963005 | A2297L3158 A164002 | - Registro freno/Brake adjuster <i>Meritor System</i> | Axle |
|  | | | |

**KIT RIPARAZIONE
REPAIRING KIT
KIT REPARATION
REPARATURSATZ
РЕМКОМПЛЕКТЫ
JUEGO DE REPARACION**

EMMERRE
spare parts for trucks and trailers

ROR

| Applicazioni / Applications | Dettagli / Detail | Adattabile a / Adaptable to | Emmerre |
|-----------------------------|---|-----------------------------|---|
| Axle | - Boccola zigrinata/ <i>Knurled bushing</i> <i>Meritor System</i> | 328058131 | 963006 |
| | | |  |
| Axle | - Astuccio/ <i>Holder</i> <i>Meritor System</i> | 3280Y8163 | 963007 |
| | | |  |
| Axle | - Kit registro freni completo/ <i>Complete Brake adjuster kit</i> <i>Meritor System</i> | RBSK0502 | 963001 |
| | | |  |
| Axle | - Kit cunei freno/ <i>Brake wedges kit</i> <i>Meritor System</i> | RBSK0250 RBSK13141 | 963024 |
| | | |  |

I riferimenti indicati non sono originali ma perfettamente intercambiabili. I codici originali e le case costruttrici sono indicati a puro titolo informativo
The details described are not original but perfectly interchangeable. The original references and manufacturer names are given for information purposes only.

| Emmerre | Adattabile a / Adaptable to | Dettagli / Detail | Applicazioni / Applications |
|---|-----------------------------|---|-----------------------------|
| 963023 | RBSK02491B | - Kit pistoni freno/ <i>Brake pistons kit</i> - Destra/ <i>Right</i> <i>Meritor System</i> | Axle |
|  | | | |
| 963022 | RBSK02481B RBSK0248 | - Kit pistoni freno/ <i>Brake pistons kit</i> - Sinistra/ <i>Left</i> <i>Meritor System</i> | Axle |
|  | | | |
| 963025 | RBSK02511B | - Kit cuffie/ <i>Protective hoods set</i> <i>Meritor System</i> | Axle |
|  | | | |
| 963026 | RBSK03431B | - Kit molle ganasce freno/ <i>Shoes springs kit</i> <i>Meritor System</i> | Axle |
|  | | | |





**KIT RIPARAZIONE
REPAIRING KIT
KIT REPARATION
REPARATURSATZ
РЕМКОМПЛЕКТЫ
JUEGO DE REPARACION**

EMMERRE
spare parts for trucks and trailers

ROR

| Applicazioni / Applications | Dettagli / Detail | Adattabile a / Adaptable to | Emmerre |
|-----------------------------|---|---|---------------|
| Axle | - Kit riparazione freno ridotto/ <i>Brake reduced kit</i> <i>Meritor System</i> | RBSK0549 | 963020 |
| | |  | |
| Axle | - Tubetto grasso/Grease <i>Meritor System</i> | RBSK0253M | 963013 |
| | |  | |
| Axle | - Cuffia bassa/Low protective hood <i>Meritor System</i> | 1205B1667 | 963012 |
| | |  | |
| Axle | - Set molle freno/Brake Springs set <i>Perrot System</i> | 12999623VT | 961043 |
| | |  | |

I riferimenti indicati non sono originali ma perfettamente intercambiabili. I codici originali e le case costruttrici sono indicati a puro titolo informativo
The details described are not original but perfectly interchangeable. The original references and manufacturer names are given for information purposes only.

| Emmerre | Adattabile a / Adaptable to | Dettagli / Detail | Applicazioni / Applications |
|---|-----------------------------|---|-----------------------------|
| 960951 | RBSK15611 | - Set molle freno/ <i>Brake Springs set</i> <i>Meritor System</i> | Axle |
|  | | | |
| 960965 | RBSK1558 | - Kit fissaggio molle ganasce freno/ <i>Fixing shoes springs kit</i> <i>Meritor System</i> | Axle |
|  | | | |
| 960511 | RBSK1255M | - Kit cunei freno/ <i>Brake wedges kit</i> <i>Meritor System</i> | Axle |
|  | | | |
| 960603 | RBSK15571 | - Kit revisione freni/ <i>Brake overhaul kit</i> <i>Meritor System</i> | Axle |
|  | | | |

KIT RIPARAZIONE
REPAIRING KIT
KIT REPARATION
REPARATURSATZ
РЕМКОМПЛЕКТЫ
JUEGO DE REPARACION

EMMERRE
spare parts for trucks and trailers

ROR

| Applicazioni / Applications | Dettagli / Detail | Adattabile a / Adaptable to | Emmerre |
|-----------------------------|---|---|---------------|
| Axle | - Kit revisione freni/ <i>Brake overhaul kit</i> <i>Meritor System</i> | RBSK1563 | 960601 |
| | |  | |
| Axle | - Cuffia bassa/ <i>Low protective hood</i> <i>Meritor System</i> | 1205Y2001 | 963027 |
| | |  | |
| Axle | - Dispositivo a cuneo/ <i>Device</i> <i>Meritor System</i> | A2247U47 | 963017 |
| | |  | |
| Axle | - Stantuffo destro/ <i>Plunger right</i> <i>Meritor System</i> | 2297K4821 | 963014 |
| | |  | |

| Emmerre | Adattabile a / Adaptable to | Dettagli / Detail | Applicazioni / Applications |
|---|-----------------------------|---|-----------------------------|
| 963015 | 2297J4820 | - Stantuffo sinistro/ <i>Plunger left</i> <i>Meritor System</i> | Axle |
|  | | | |
| 963016 | 2257M1001 | - Molla/ <i>Spring</i> <i>Meritor System</i> | Axle |
|  | | | |
| 963106 | 3211J302635 | - Supporto massa freno/ <i>Brake wheel support</i> <i>Meritor System</i> | Axle |
|  | | | |
| 963533 | RBSK1408 | - Kit riparazione freno/ <i>Brake repair kit</i> <i>Meritor System</i> | Axle |
|  | | | |

**KIT RIPARAZIONE
REPAIRING KIT
KIT REPARATION
REPARATURSATZ
РЕМКОМПЛЕКТЫ
JUEGO DE REPARACION**

EMMERRE
spare parts for trucks and trailers

ROR





| Applicazioni / Applications | Dettagli / Detail | Adattabile a / Adaptable to | Emmerre |
|-----------------------------|---|---|---------------|
| Axle | - Kit riparazione freno ridotto/ <i>Brake reduced kit</i> <i>Meritor System</i> | RBSK1407 | 963534 |
| | |  | |
| Axle | - Kit cunei freno/Brake wedges kit <i>Meritor System</i> | RBSK2051M | 963536 |
| | |  | |
| Axle | - Kit cuffie/Protective hoods set <i>Meritor System</i> | RBSK2030M | 963535 |
| | |  | |
| Axle | - Cuffia/Protective hood <i>Meritor System</i> | 1205X2000 | 963541 |
| | |  | |

| Emmerre | Adattabile a / Adaptable to | Dettagli / Detail | Applicazioni / Applications |
|---|-----------------------------|---|-----------------------------|
| 963537 | RBSK1481M | - Kit perni freno sinistro/ <i>Brake pins set left</i> <i>Meritor System</i> | Axle |
|  | | | |
| 963538 | RBSK1482M | - Kit perni freno destro/ <i>Brake pins set right</i> <i>Meritor System</i> | Axle |
|  | | | |
| 963539 | RBSK2128M | - Set molle/ <i>Springs set</i> <i>Meritor System</i> | Axle |
|  | | | |
| 963553 | 12999410 | - Kit cunei freno/ <i>Brake wedges kit</i> <i>Meritor System</i> | Axle |
|  | | | |





**KIT RIPARAZIONE
REPAIRING KIT
KIT REPARATION
REPARATURSATZ
РЕМКОМПЛЕКТЫ
JUEGO DE REPARACION**

EMMERRE
spare parts for trucks and trailers

ROR

| Applicazioni / Applications | Dettagli / Detail | Adattabile a / Adaptable to | Emmerre |
|-----------------------------|--|---|---------------|
| Axle | - Kit revisione boccole freno/ <i>Overhaul kit for brake bush</i> <i>Perrot System</i> | 12999411VT | 963548 |
| | |  | |
| Axle | - Set molle freno/Brake Springs set <i>Perrot System</i> | 12999443 | 963556 |
| | |  | |
| Axle | - Set molle freno/Brake Springs set <i>Perrot System</i> | 12999573VT | 963555 |
| | |  | |
| Axle | - Supporto gruppo freno/ <i>Brake assembly support</i> <i>Meritor System</i> | 3211P675035 | 963131 |
| | |  | |

I riferimenti indicati non sono originali ma perfettamente intercambiabili. I codici originali e le case costruttrici sono indicati a puro titolo informativo
The details described are not original but perfectly interchangeable. The original references and manufacturer names are given for information purposes only.

| Emmerre | Adattabile a / Adaptable to | Dettagli / Detail | Applicazioni / Applications |
|---|-----------------------------|--|-----------------------------|
| 963594 | RBSK2301 | - Kit registro freni completo/ Complete brake adjuster kit <i>Meritor System</i> | Axle |
|  | | | |
| 963595 | RBSK1606M | - Kit pistoni freno/Brake piston kit - Parte fissa/Fixed part - Lato destro/Right side <i>Meritor System</i> | Axle |
|  | | | |
| 963569 | RBSK16001 RBSK1607 | - Kit pistoni freno/Brake piston kit - Parte fissa/Fixed part - Lato sinistro/Left side <i>Meritor System</i> | Axle |
|  | | | |
| 963574 | RBSK16251 | - Kit cuffie/Protective hoods set <i>Meritor System</i> | Axle |
|  | | | |





**KIT RIPARAZIONE
REPAIRING KIT
KIT REPARATION
REPARATURSATZ
РЕМКОМПЛЕКТЫ
JUEGO DE REPARACION**

EMMERRE
spare parts for trucks and trailers

ROR

| Applicazioni / Applications | Dettagli / Detail | Adattabile a / Adaptable to | Emmerre |
|-----------------------------|---|-----------------------------|---------------|
| Axle | <ul style="list-style-type: none"> - Kit pistoni freno/<i>Brake piston kit</i> - Parte fissa/<i>Fixed part</i> - Lato destro/<i>Right side</i> <p><u>Meritor System</u></p> | RBSK1599M | 963465 |
| Axle | <ul style="list-style-type: none"> - Kit pistoni freno/<i>Brake piston kit</i> - Parte fissa/<i>Fixed part</i> - Lato sinistro/<i>Left side</i> <p><u>Meritor System</u></p> | RBSK1600M | 963466 |
| Axle | <ul style="list-style-type: none"> - Kit pistoni freno/<i>Brake piston kit</i> - Parte fissa/<i>Fixed part</i> - Lato destro/<i>Right side</i> <p><u>Meritor System</u></p> | RBSK15951 | 963467 |
| Axle | <ul style="list-style-type: none"> - Kit pistoni freno/<i>Brake piston kit</i> - Parte fissa/<i>Fixed part</i> - Lato sinistro/<i>Left side</i> <p><u>Meritor System</u></p> | RBSK15961 | 963468 |







| Emmerre | Adattabile a / <i>Adaptable to</i> | Dettagli / <i>Detail</i> | Applicazioni / <i>Applications</i> |
|--|------------------------------------|---|------------------------------------|
| <p>963625</p>  | <p>RBSK20311</p> | <p>- Kit cuffie/<i>Protective hoods set</i></p> <p><i>Meritor System</i></p> | <p>Axle</p> |
| <p>963626</p>  | <p>RBSK15851</p> | <p>- Kit pistoni freno/<i>Brake piston kit</i> - Per massa freno completa/ <i>For complete wheel brake</i> - Sinistra/<i>Left</i></p> <p><i>Meritor System</i></p> | <p>Axle</p> |
| <p>963627</p>  | <p>RBSK15841</p> | <p>- Kit pistoni freno/<i>Brake piston kit</i> - Per massa freno completa/ <i>For complete wheel brake</i> - Destra/<i>Right</i></p> <p><i>Meritor System</i></p> | <p>Axle</p> |
| <p>963575</p>  | <p>A229758287</p> | <p>- Dispositivo registro freno/ <i>Brake adjuster device</i></p> <p><i>Meritor System</i></p> | <p>Axle</p> |

KIT RIPARAZIONE
REPAIRING KIT
KIT REPARATION
REPARATURSATZ
РЕМКОМПЛЕКТЫ
JUEGO DE REPARACION

EMMERRE
spare parts for trucks and trailers

ROR

| Applicazioni / Applications | Dettagli / Detail | Adattabile a / Adaptable to | Emmerre |
|-----------------------------|--|--|---------------|
| Axle | - Cuffia bassa/Low protective hood <u>Meritor System</u> | 1205E2683 | 963576 |
| | |  | |
| Axle | - Kit fissaggio ganasce freno/ Brake shoes fixing kit <u>Meritor System</u> | RBSK1409 | 963540 |
| | |  | |
| Axle | - Set molle freno/Brake Springs set <u>Meritor System</u> | RBSK1586M | 963560 |
| | |  | |
| Axle | - Kit registro freni completo/ Complete brake adjuster kit <u>Meritor System</u> | RBSK1560 | 963904 |
| | |  | |





I riferimenti indicati non sono originali ma perfettamente intercambiabili. I codici originali e le case costruttrici sono indicati a puro titolo informativo
The details described are not original but perfectly interchangeable. The original references and manufacturer names are given for information purposes only.

| Emmerre | Adattabile a / Adaptable to | Dettagli / Detail | Applicazioni / Applications |
|---|-----------------------------|--|-----------------------------|
| 962504 | 1227L1156 | - Ghiera cilindro freno/ Brake cylinder ring nut - 1' 3/4 | Axle |
|  | | | |
| 963602 | ST1053 | - Kit riparazione guarnizione/ Gaskets repairing kit | Axle |
|  | | | |
| 963606 | SP8540 | - Perno/Pin Z-Cam | Axle |
|  | | | |
| 963584 | ST4013 | - Dispositivo registro/ Adjuster device Z-Cam - Destra/Right | Axle |
|  | | | |





**KIT RIPARAZIONE
REPAIRING KIT
KIT REPARATION
REPARATURSATZ
РЕМКОМПЛЕКТЫ
JUEGO DE REPARACION**

EMMERRE
spare parts for trucks and trailers

ROR

| Applicazioni / Applications | Dettagli / Detail | Adattabile a / Adaptable to | Emmerre |
|-----------------------------|---|---|---------------|
| Axle | - Dispositivo registro/ Adjuster device Z-Cam - Sinistra/Left | ST4014 | 963585 |
| | |  | |
| Axle | - Kit revisione/Overhaul kit - Sinistra/Left - Z-Cam | ST1036 | 963586 |
| | |  | |
| Axle | - Kit revisione/Overhaul kit - Destra/Right - Z-Cam | ST1037 | 963587 |
| | |  | |
| Axle | - Kit revisione/Overhaul kit - Sinistra/Left - Z-Cam | SP8548 | 963588 |
| | |  | |





I riferimenti indicati non sono originali ma perfettamente intercambiabili. I codici originali e le case costruttrici sono indicati a puro titolo informativo
The details described are not original but perfectly interchangeable. The original references and manufacturer names are given for information purposes only.

| Emmerre | Adattabile a / Adaptable to | Dettagli / Detail | Applicazioni / Applications |
|---|-----------------------------|---|-----------------------------|
| 963589 | SP8549 | - Kit revisione/ <i>Overhaul kit</i> - Destra/ <i>Right</i> - Z-Cam | Axle |
|  | | | |
| 963612 | ST1035 | - Kit revisione/ <i>Overhaul kit</i> - Z-Cam | Axle |
|  | | | |
| 961002 | ST1038 | - Dispositivo registro/ <i>Adjuster device Z-cam</i> - Sinistra/ <i>Left</i> | Axle |
|  | | | |
| 961003 | ST1039 | - Dispositivo registro/ <i>Adjuster device Z-cam</i> - Destra/ <i>Right</i> | Axle |
|  | | | |





**KIT RIPARAZIONE
REPAIRING KIT
KIT REPARATION
REPARATURSATZ
РЕМКОМПЛЕКТЫ
JUEGO DE REPARACION**

EMMERRE
spare parts for trucks and trailers

SCANIA

| Applicazioni / Applications | Dettagli / Detail | Adattabile a / Adaptable to | Emmerre |
|--|--|-----------------------------|---|
| Series 3 Series 4 Bus Series P/G/R/T | - Membrana corta tipo/ <i>Membrane short type 9"</i> - Ø mm. 128 x 30 - Battuta/Stroke mm.44 | 203670 189644 | 970801 |
| | | |  |
| Series 3 Series 4 Bus Series P/G/R/T | - Membrana corta tipo/ <i>Membrane short type 16"</i> - Ø mm. 158 x 36 - Battuta/Stroke mm.57 | 1802698 160342 | 970803 |
| | | |  |
| Series 3 | - Membrana corta tipo/ <i>Membrane short type 20"</i> - Ø mm. 168 x 38 - Battuta/Stroke mm.57 | 1104252 151476 181331 | 970804 |
| | | |  |
| Series 3 | - Membrana corta tipo/ <i>Membrane short type 24"</i> - Ø mm. 178 x 42 - Battuta/Stroke mm.64 | 143112 1784593 | 970805 |
| | | |  |

I riferimenti indicati non sono originali ma perfettamente intercambiabili. I codici originali e le case costruttrici sono indicati a puro titolo informativo
The details described are not original but perfectly interchangeable. The original references and manufacturer names are given for information purposes only.

| Emmerre | Adattabile a / Adaptable to | Dettagli / Detail | Applicazioni / Applications |
|---|-----------------------------|---|--|
| 970806 | 1104202 143113 176232 | - Membrana corta tipo/ <i>Membrane short type 30"</i> - Ø mm. 201 x 36 - Battuta/ <i>Stroke</i> mm.64 | Series 3 |
|  | | | |
| 970808 | 171566 1325347 | - Membrana media tipo/ <i>Membrane medium type 12"</i> - Ø mm. 139 x 50 - Battuta/ <i>Stroke</i> mm.70 | Series 3 Series 3 Bus |
|  | | | |
| 970810 | 1303474 1333810 | - Membrana lunga tipo/ <i>Membrane long type 20"</i> - Ø mm. 168 x 50 - Battuta/ <i>Stroke</i> mm.76 | Series 3 Series 4 Series 3 Bus Series 4 Bus Series P/G/R/T |
|  | | | |
| 970811 | 1320138 | - Membrana lunga tipo/ <i>Membrane long type 24"</i> - Ø mm. 178 x 52 - Battuta/ <i>Stroke</i> mm.76 | Series 3 Series 4 Bus Series P/G/R/T |
|  | | | |

**KIT RIPARAZIONE
REPAIRING KIT
KIT REPARATION
REPARATURSATZ
РЕМКОМПЛЕКТЫ
JUEGO DE REPARACION**

EMMERRE
spare parts for trucks and trailers

SCANIA

| Applicazioni / Applications | Dettagli / Detail | Adattabile a / Adaptable to | Emmerre |
|-----------------------------|--|-----------------------------|---------------|
| Series 3 Bus | - Membrana lunga tipo/ | 1303475 | 970812 |
| Series 4 Bus | <i>Membrane long type 30"</i> | 1802699 | |
| Series P/G/R/T | - Ø mm. 203 x 52 - Battuta/Stroke mm.76 | | |



EMMERRE

spare parts for trucks and trailers

VOLVO

KIT RIPARAZIONE
REPAIRING KIT
KIT REPARATION
REPARATURSATZ
РЕМКОМПЛЕКТЫ
JUEGO DE REPARACION

| Emmerre | Adattabile a / Adaptable to | Dettagli / Detail | Applicazioni / Applications |
|---|-----------------------------|--|-----------------------------|
| 963020 | 272857 | - Kit riparazione freno ridotto/ <i>Brake reduced kit</i> - Anteriore/ <i>Front</i> <i>Meritor System</i> | FL 6 |
|  | | | |
| 963010 | 1695051 | - Molla freno/ <i>Brake spring</i> - Anteriore e posteriore/ <i>Front and rear</i> <i>Meritor System</i> | FL 6 |
|  | | | |
| 963011 | 1696218 | - Cuffia alta/ <i>High protective hood</i> - Anteriore e posteriore/ <i>Front and rear</i> <i>Meritor System</i> | FL 6 |
|  | | | |
| 963012 | 1696219 | - Cuffia bassa/ <i>Low protective hood</i> - Anteriore e posteriore/ <i>Front and rear</i> <i>Meritor System</i> | FL 6 |
|  | | | |

KIT RIPARAZIONE
REPAIRING KIT
KIT REPARATION
REPARATURSATZ
РЕМКОМПЛЕКТЫ
JUEGO DE REPARACION

EMMERRE
spare parts for trucks and trailers

VOLVO

| Applicazioni / Applications | Dettagli / Detail | Adattabile a / Adaptable to | Emmerre |
|-----------------------------|--|-----------------------------|--|
| FH 12/16 | - Cuffia/Protective hood <i>Meritor System</i> | 1698588 | 963541 |
| | | |  |
| FH 12/16 | - Ghiera cilindro freno/Brake cylinder ring nut - 1' 3/4 | 6773786 | 962504 |
| | | |  |
| FH 12/16 | - Membrana corta tipo/ <i>Membrane short type 9"</i> - Ø mm. 128 x 30 - Battuta/Stroke mm.44 | 353314 | 970801 |
| | | |  |
| FH 12/16 | - Membrana corta tipo/ <i>Membrane short type 16"</i> - Ø mm. 158 x 36 - Battuta/Stroke mm.57 | 1696583 1609308 | 970803 |
| | | |  |

EMMERRE

spare parts for trucks and trailers

VOLVO

KIT RIPARAZIONE
REPAIRING KIT
KIT REPARATION
REPARATURSATZ
РЕМКОМПЛЕКТЫ
JUEGO DE REPARACION

| Emmerre | Adattabile a / Adaptable to | Dettagli / Detail | Applicazioni / Applications |
|---|------------------------------|---|-----------------------------|
| 970805 | 1609310 338452 1614798 | - Membrana corta tipo/ <i>Membrane short type 24"</i> - Ø mm. 178 x 42 - Battuta/ <i>Stroke</i> mm.64 | FH 12/16 |
|  | | | |
| 970806 | 1609311 1614799 | - Membrana corta tipo/ <i>Membrane short type 30"</i> - Ø mm. 201 x 36 - Battuta/ <i>Stroke</i> mm.64 | FH 12/16 |
|  | | | |
| 970808 | 6210873 325197 | - Membrana media tipo/ <i>Membrane medium type 12"</i> - Ø mm. 139 x 50 - Battuta/ <i>Stroke</i> mm.70 | FH 12/16 |
|  | | | |
| 970809 | 3090848 | - Membrana lunga tipo/ <i>Membrane long type 16"</i> - Ø mm. 158 x 58 - Battuta/ <i>Stroke</i> mm.44 | FH 12/16 |
|  | | | |

**KIT RIPARAZIONE
REPAIRING KIT
KIT REPARATION
REPARATURSATZ
РЕМКОМПЛЕКТЫ
JUEGO DE REPARACION**

EMMERRE
spare parts for trucks and trailers

VOLVO

| Applicazioni / Applications | Dettagli / Detail | Adattabile a / Adaptable to | Emmerre |
|--|---|------------------------------|---|
| FH 12/16 | - Membrana lunga tipo/ <i>Membrane long type 20"</i> - Ø mm. 168 x 50 - Battuta/Stroke mm.76 | 3090925 | 970810 |
| | | |  |
| FH 12/16 | - Membrana lunga tipo/ <i>Membrane long type 24"</i> - Ø mm. 178 x 52 - Battuta/Stroke mm.76 | 6212195 1698126 341425 | 970811 |
| | | |  |
| F 12 F 16 FH 12 FH 16 FL/FM FMX NH | - Kit riparazione guarnizione/ <i>Gaskets repairing kit</i> - Z-Cam | 272905 ST1053 | 963602 |
| | | |  |
| F 12 F 16 FH 12 FH 16 FL/FM FMX NH | - Cuffia/Protective hood | 3090954 1696448 | 963604 |
| | | |  |

| Emmerre | Adattabile a / Adaptable to | Dettagli / Detail | Applicazioni / Applications |
|---|-------------------------------|---|--|
| 963606 | 272910 1696453 | - Perno/Pin Z-Cam | F 12 F 16 FH 12 FH 16 FL/FM FMX NH |
|  | | | |
| 963607 | 1696446 | - Perno/Pin Z-Cam | F 12 F 16 FH 12 FH 16 FL/FM FMX NH |
|  | | | |
| 963608 | 3097299 1698346 1696445 | - Perno/Pin Z-Cam | F 12 F 16 FH 12 FH 16 FL/FM FMX NH |
|  | | | |
| 963610 | 1696924 | - Pignone registro/ Adjuster pinion Z-Cam - Sinistra/Left | F 12 F 16 FH 12 FH 16 FL/FM FMX NH |
|  | | | |





**KIT RIPARAZIONE
REPAIRING KIT
KIT REPARATION
REPARATURSATZ
РЕМКОМПЛЕКТЫ
JUEGO DE REPARACION**

EMMERRE
spare parts for trucks and trailers

VOLVO

| Applicazioni / Applications | Dettagli / Detail | Adattabile a / Adaptable to | Emmerre |
|--|--|---|---|
| F 12 F 16 FH 12 FH 16 FL/FM FMX NH | - Pignone registro/ <i>Adjuster pinion Z-Cam</i> - Destra/ <i>Right</i> | 1696925 | 963611 |
| | | |  |
| F 12 F 16 FH 12 FH 16 FL/FM FMX NH | - Dispositivo registro/ <i>Adjuster device Z-Cam</i> - Destra/ <i>Right</i> | 8550977 3097100 272908 | 963584 |
| | | |  |
| F 12 F 16 FH 12 FH 16 FL/FM FMX NH | - Dispositivo registro/ <i>Adjuster device Z-Cam</i> - Sinistra/ <i>Left</i> | 3098276 8550978 3097099 272909 | 963585 |
| | | |  |
| F 12 F 16 FH 12 FH 16 FL/FM FMX NH | - Kit revisione/ <i>Overhaul kit</i> - Sinistra/ <i>Left</i> - Z-Cam | 276097 | 963586 |
| | | |  |

I riferimenti indicati non sono originali ma perfettamente intercambiabili. I codici originali e le case costruttrici sono indicati a puro titolo informativo
The details described are not original but perfectly interchangeable. The original references and manufacturer names are given for information purposes only.

| Emmerre | Adattabile a / Adaptable to | Dettagli / Detail | Applicazioni / Applications |
|---|-----------------------------|--|--|
| 963587 | 276098 | - Kit revisione/ <i>Overhaul kit</i> - Destra/ <i>Right</i> - Z-Cam | F 12 F 16 FH 12 FH 16 FL/FM FMX NH |
|  | | | |
| 963588 | 272906 | - Kit revisione/ <i>Overhaul kit</i> - Sinistra/ <i>Left</i> - Z-Cam | F 12 F 16 FH 12 FH 16 FL/FM FMX NH |
|  | | | |
| 963589 | 272907 | - Kit revisione/ <i>Overhaul kit</i> - Destra/ <i>Right</i> - Z-Cam | F 12 F 16 FH 12 FH 16 FL/FM FMX NH |
|  | | | |
| 963612 | 3090964 276100 | - Kit revisione/ <i>Overhaul kit</i> - Z-Cam | F 12 F 16 FH 12 FH 16 FL/FM FMX NH |
|  | | | |

**KIT RIPARAZIONE
REPAIRING KIT
KIT REPARATION
REPARATURSATZ
РЕМКОМПЛЕКТЫ
JUEGO DE REPARACION**

EMMERRE
spare parts for trucks and trailers

VOLVO

| Applicazioni / Applications | Dettagli / Detail | Adattabile a / Adaptable to | Emmerre |
|---|---|-----------------------------|--|
| All Trucks | - Dispositivo registro/Adjuster device Z-cam - Sinistra/Left | 3090997 | 961002 |
| | | |  |
| All Trucks | - Dispositivo registro/Adjuster device Z-cam - Destra/Right | 3090998 | 961003 |
| | | |  |
| F 12/16 FH 12/16 FL/FM FMX NH | - Kit revisione Z-Cam completo/ Complete Z-Cam revision kit - Destra/Right | -- | 963632 |
| | | |  |
| F 12/16 FH 12/16 FL/FM FMX NH | - Kit revisione Z-Cam completo/ Complete Z-Cam revision kit - Sinistra/Left | -- | 963633 |
| | | |  |

I riferimenti indicati non sono originali ma perfettamente intercambiabili. I codici originali e le case costruttrici sono indicati a puro titolo informativo
The details described are not original but perfectly interchangeable. The original references and manufacturer names are given for information purposes only.

Emmerre

Adattabile a / *Adaptable to*

Dettagli / *Detail*

Applicazioni / *Applications*

IMPIANTO IDRAULICO
HYDRAULIC SYSTEM
SYSTEME HYDRAULIQUE
HYDRAULIKSYSTEM
ГИДРАВЛИЧЕСКАЯ СИСТЕМА
SISTEMA HIDRAULICO

EMMERRE
 spare parts for trucks and trailers

FIAT

| Applicazioni / Applications | Dettagli / Detail | Adattabile a / Adaptable to | Emmerre |
|---|--|-----------------------------|---------------|
| Ducato Citroen Jumper Peugeot Boxer | - Cilindro freno posteriore/Rear brake cylinder - Ø mm. 28,60 | 9945895 4402A5 | 964022 |



| Emmerre | Adattabile a / Adaptable to | Dettagli / Detail | Applicazioni / Applications |
|---|-------------------------------|---|-----------------------------|
| 964202 | 1560029 | - Cilindro freno destro/sinistro Brake cylinder right/left - Ø mm. 15,80 - <u>AP Lockheed system</u> | Transit |
|  | | | |
| 964201 | 1560032 | - Cilindro freno destro/sinistro Brake cylinder right/left - Ø mm.17,40 - <u>AP Lockheed system</u> | Transit |
|  | | | |
| 964203 | 1443447 1478964 1561166 | - Cilindro freno destro/sinistro Brake cylinder right/left - Ø mm.19,05 - <u>AP Lockheed system</u> | Transit |
|  | | | |





IMPIANTO IDRAULICO
HYDRAULIC SYSTEM
SYSTEME HYDRAULIQUE
HYDRAULIKSYSTEM
ГИДРАВЛИЧЕСКАЯ СИСТЕМА
SISTEMA HIDRAULICO

EMMERRE
spare parts for trucks and trailers

IVECO

| Applicazioni / Applications | Dettagli / Detail | Adattabile a / Adaptable to | Emmerre |
|--|--|---|---|
| Daily Restyling New Daily | - Cilindro freno destro/sinistro <i>Brake cylinder right/left</i> - Ø mm. 15,80 - <u>AP Lockheed system</u> | 8121576 9983871 9983471 | 964202 |
| | | |  |
| Daily Restyling New Daily | - Cilindro freno destro/sinistro <i>Brake cylinder right/left</i> - Ø mm.17,40 - <u>AP Lockheed system</u> | 8121575 7980525 9983470 | 964201 |
| | | |  |
| Turbodaily 35.10 | - Cilindro freno destro/sinistro <i>Brake cylinder right/left</i> - Ø mm.19,05 - <u>AP Lockheed system</u> | 2997355 93160540 93159002 | 964203 |
| | | |  |
| Daily Restyling New Daily Turbodaily | - Cilindro freno destro/sinistro <i>Brake cylinder right/left</i> - Ø mm. 20,60 - <u>Perrot system</u> | 2997354 93155720 8123580 8194527 | 964211 |
| | | |  |





I riferimenti indicati non sono originali ma perfettamente intercambiabili. I codici originali e le case costruttrici sono indicati a puro titolo informativo
The details described are not original but perfectly interchangeable. The original references and manufacturer names are given for information purposes only.

| Emmerre | Adattabile a / Adaptable to | Dettagli / Detail | Applicazioni / Applications |
|---|-----------------------------|--|---|
| 964204 | 2997420 98452387 | - Cilindro freno destro/sinistro <i>Brake cylinder right/left</i> - Ø mm. 23,80 | Turbodaily 59.12 |
|  | | | |
| 964205 | 4122369 | - Cilindro freno destro/sinistro <i>Brake cylinder right/left</i> - Anteriore e posteriore/ <i>Front and rear</i> - Ø mm. 28,50 | 616N1 616N2 616N3 625N1 625N2 |
|  | | | |
| 964209 | 4276036 | - Cilindro freno destro/sinistro <i>Brake cylinder right/left</i> - Anteriore/ <i>Front</i> - Ø mm. 27 | OM 35 OM 40 OM 50 OM 55 |
|  | | | |
| 964210 | 4220639 | - Cilindro freno destro/sinistro <i>Brake cylinder right/left</i> - Posteriore/ <i>Rear</i> - Ø mm. 22,22 | OM 35 OM 40 OM 50 OM 55 |
|  | | | |

IMPIANTO IDRAULICO
HYDRAULIC SYSTEM
SYSTEME HYDRAULIQUE
HYDRAULIKSYSTEM
ГИДРАВЛИЧЕСКАЯ СИСТЕМА
SISTEMA HIDRAULICO

EMMERRE
spare parts for trucks and trailers

IVECO

| Applicazioni / Applications | Dettagli / Detail | Adattabile a / Adaptable to | Emmerre |
|---|--|--|---|
| Turbozeta Zeta 50.8 - 50.9 - 50.10 60.10 - 65.12 | - Cilindro freno destro/sinistro <i>Brake cylinder right/left</i> - Posteriore/Rear - Ø mm .23,80 | 2997461 4712856 | 964214 |
| | | |  |
| 65 - 70 - 75 Zeta OM Leoncino Eurocargo | - Cilindro freno destro/sinistro <i>Brake cylinder right/left</i> - Anteriore e posteriore/ <i>Front and rear</i> - Ø mm .25,40 | 2997337 4220643 7165213 | 964217 |
| | | |  |
| Turbozeta Zeta 79.10 - 79.12 - 79.14 | - Cilindro freno destro/sinistro <i>Brake cylinder right/left</i> - Anteriore e posteriore/ <i>Front and rear</i> - Ø mm . 27 | 2997520 4744164 4727624 4727809 | 964220 |
| | | |  |
| 100 110 130NC | - Cilindro freno destro/sinistro <i>Brake cylinder right/left</i> - Anteriore e posteriore/ <i>Front and rear</i> - Ø mm. 50,80 | 2997339 500039974 4294681 | 964235 |
| | | |  |

I riferimenti indicati non sono originali ma perfettamente intercambiabili. I codici originali e le case costruttrici sono indicati a puro titolo informativo
The details described are not original but perfectly interchangeable. The original references and manufacturer names are given for information purposes only.

| Emmerre | Adattabile a / Adaptable to | Dettagli / Detail | Applicazioni / Applications |
|---|--|--|---|
| 964234 | 4212449 | - Cilindro freno destro/sinistro <i>Brake cylinder right/left</i> - Anteriore e posteriore/ <i>Front and rear</i> - Ø mm. 50,80 | 662N3 673-314/3 |
|  | | | |
| 964213 | 2997456 93155721 8121103 8193387 7984212 | - Cilindro freno posteriore <i>Rear brake cylinder</i> - Ø mm . 28,60 | Zeta 95.14 |
|  | | | |
| 964216 | 93155722 7984278 8121104 | - Cilindro freno posteriore <i>Rear brake cylinder</i> - Ø mm. 31,75 | Zeta 109.14 |
|  | | | |
| 964013 | 2997353 9989017 | - Pompa freno/ <i>Brake pump</i> - Flangia ovale/ <i>Oval flange</i> - Ø mm. 20,60 - <i>Bendix system</i> | Daily Restyling New Daily Turbodaily |
|  | | | |
| Connessione / Connected: | | |  4791100 |

IMPIANTO IDRAULICO
HYDRAULIC SYSTEM
SYSTEME HYDRAULIQUE
HYDRAULIKSYSTEM
ГИДРАВЛИЧЕСКАЯ СИСТЕМА
SISTEMA HIDRAULICO

EMMERRE
spare parts for trucks and trailers

IVECO

| Applicazioni / Applications | Dettagli / Detail | Adattabile a / Adaptable to | Emmerre |
|---|--|-----------------------------|---------------|
| Daily Restyling 45.10 49.10 | - Pompa freno/ <i>Brake pump</i> - Flangia quadrata/ <i>Square flange</i> - Ø mm. 25,40 - Per servofreno/ <i>For servobrake</i> 4797460 - 99436561 - <i>Bosch/Bendix system</i> | 4797280 | 964004 |
|  | | | |
| Connessione / Connected: 4797460 | | | |
| Turbodaily 59.12 | - Pompa freno/ <i>Brake pump</i> - Ø mm. 28,60 - Per servofreno/ <i>For servobrake</i> 99463713 - 60188878 | 2991751 | 964031 |
|  | | | |
| Connessione / Connected: 99463713-60188878-98434065 | | | |
| Turbodaily 49.12 | - Pompa freno/ <i>Brake pump</i> - Ø mm. 27 - Per servofreno/ <i>For servobrake</i> 99483920 | -- | 964032 |
|  | | | |
| Connessione / Connected: 99483920-99459380-500374416-504042984 | | | |
| Daily City 2000 35-C9-11-12 35C13-15 50-C11-13 65-C15 | - Pompa freno/ <i>Brake pump</i> - Ø mm. 25,40 | 2991743 42530542 | 964404 |
|  | | | |
| Connessione / Connected: 504089709 | | | |



I riferimenti indicati non sono originali ma perfettamente intercambiabili. I codici originali e le case costruttrici sono indicati a puro titolo informativo
The details described are not original but perfectly interchangeable. The original references and manufacturer names are given for information purposes only.

| Emmerre | Adattabile a / Adaptable to | Dettagli / Detail | Applicazioni / Applications |
|---------------|-----------------------------|--|--|
| 964033 | 2997334 2991745 | - Pompa freno/ <i>Brake pump</i> - Ø mm. 23,81 | Daily City 2000 29-L11 29-L12 29-L13 35-S-9-13 35-S-11-13 |
| | | Connessione / Connected:  99487840-504099707 | |
| 964011 | 4844302 | - Pompa freno/ <i>Brake pump</i> - Con servofreno/ <i>With servobrake</i> - Ø mm. 20,60 | Daily 30.8 35.8 35.10 |
| 964003 | -- | - Pompa freno/ <i>Brake pump</i> - Ø mm. 27 - Per servofreno/ <i>For servobrake</i> 504089710 | Daily 50-C13 |
| | | Connessione / Connected:  500374416-504042984-504089710 | |
| 964001 | -- | - Pompa freno/ <i>Brake pump</i> - Ø mm. 28,60 - Per servofreno/ <i>For servobrake</i> 504089711 | Daily 65-C15 |
| | | Connessione / Connected:  504089711-500359653-504042985 | |

IMPIANTO IDRAULICO
HYDRAULIC SYSTEM
SYSTEME HYDRAULIQUE
HYDRAULIKSYSTEM
ГИДРАВЛИЧЕСКАЯ СИСТЕМА
SISTEMA HIDRAULICO

EMMERRE
spare parts for trucks and trailers

IVECO



| Applicazioni / Applications | Dettagli / Detail | Adattabile a / Adaptable to | Emmerre |
|---|--|-------------------------------|---|
| Daily 2014/2016 | - Pompa freno/ <i>Brake pump</i> | 42568306 | 964000 |
| | | |  |
| 612 N2 612 N3N 612 N4 625 N1 625 N2 | - Pompa freno/ <i>Brake pump</i> - Ø mm. 31,75 | 4277619 4210961 9290536 | 964002 |
| | | |  |
| OM 40 OM 40/35 Zeta | - Pompa freno/ <i>Brake pump</i> - Con accessori/ <i>With fittings</i> - Ø mm. 25,40 | 2997346 4797844 | 964005 |
| | | |  |
| 50 55 Gammazeta | - Pompa freno/ <i>Brake pump</i> - Ø mm. 25,40 | 2997345 4797843 | 964009 |
| | | |  |

I riferimenti indicati non sono originali ma perfettamente intercambiabili. I codici originali e le case costruttrici sono indicati a puro titolo informativo
The details described are not original but perfectly interchangeable. The original references and manufacturer names are given for information purposes only.

EMMERRE

spare parts for trucks and trailers

IVECO**IMPIANTO IDRAULICO**
HYDRAULIC SYSTEM
SYSTEME HYDRAULIQUE
HYDRAULIKSYSTEM
ГИДРАВЛИЧЕСКАЯ СИСТЕМА
SISTEMA HIDRAULICO

| Emmerre | Adattabile a / <i>Adaptable to</i> | Dettagli / <i>Detail</i> | Applicazioni / <i>Applications</i> |
|--|--|--|---|
| 964006  | 2997343 4765078 4237415 4723798 | - Pompa freno/ <i>Brake pump</i> - Con accessori/ <i>With fittings</i> - Ø mm. 25,40 | OM50-55 F8/10 65-75-79F10/F13 OM Leoncino Zeta |
| 964010  | 4797846 4721716 | - Pompa freno/ <i>Brake pump</i> - Ø mm. 25,40 | Turbozeta Zeta |
| 964016  | 2997351 4804132 | - Pompa freno/ <i>Brake pump</i> - Ø mm. 27 | Turbozeta Zeta |
| 964007  | 2997350 4804131 | - Pompa freno/ <i>Brake pump</i> - Ø mm. 28,60 | Turbozeta Zeta |

IMPIANTO IDRAULICO
HYDRAULIC SYSTEM
SYSTEME HYDRAULIQUE
HYDRAULIKSYSTEM
ГИДРАВЛИЧЕСКАЯ СИСТЕМА
SISTEMA HIDRAULICO





EMMERRE
spare parts for trucks and trailers

IVECO

| Applicazioni / Applications | Dettagli / Detail | Adattabile a / Adaptable to | Emmerre |
|---|---|--|---|
| 80 90 100 110 | - Pompa freno/ <i>Brake pump</i> - Ø mm. 44,45 | 2997342 4762814 4164296 4754206 | 964008 |
| | | |  |
| Eurocargo Zeta 109.14 | - Pompa freno/ <i>Brake pump</i> - Ø mm. 31,75 | 4804129 2997349 | 964017 |
| | | |  |
| Eurocargo Eurocargo Tector | - Pompa freno/ <i>Brake pump</i> - Ø mm. 33,30 | 4817854 | 964035 |
| | | |  |
| New Daily Daily Restyling Turbodaily Turbozeta Zeta | - Correttore di frenata/ <i>Breaking control</i> | 4792417 4277473 4178751 4717095 | 964401 |
| | | |  |

I riferimenti indicati non sono originali ma perfettamente intercambiabili. I codici originali e le case costruttrici sono indicati a puro titolo informativo
The details described are not original but perfectly interchangeable. The original references and manufacturer names are given for information purposes only.





747

| Emmerre | Adattabile a / <i>Adaptable to</i> | Dettagli / <i>Detail</i> | Applicazioni / <i>Applications</i> |
|---|------------------------------------|--|--|
| 964402 | 4792418 | - Correttore di frenata/ <i>Breaking control</i> | New Daily Daily Restyling Turbodaily |
|  | | | |
| 964054 | 98407235 | - Serbatoio liquido freno/ <i>Brake fluid tank</i> | Eurocargo Tector |
|  | | | |
| 964055 | 98407236 | - Serbatoio liquido freno/ <i>Brake fluid tank</i> | Eurocargo Euroclass |
|  | | | |
| 972104 | 93822393 8797513 | - Tubo freno/ <i>Brake pipe</i> - Lunghezza/ <i>Lenght</i> mm. 492 - M16x1,5-M10x1-M10x1 | New Daily '96 Turbodaily '96 |
|  | | | |

IMPIANTO IDRAULICO
HYDRAULIC SYSTEM
SYSTEME HYDRAULIQUE
HYDRAULIKSYSTEM
ГИДРАВЛИЧЕСКАЯ СИСТЕМА
SISTEMA HIDRAULICO

EMMERRE
spare parts for trucks and trailers

IVECO





| Applicazioni / Applications | Dettagli / Detail | Adattabile a / Adaptable to | Emmerre |
|--------------------------------|--|-----------------------------|---|
| Daily Restyling | - Tubo freno/Brake pipe - Lunghezza/Lenght mm. 532 - M16x1,5-M10x1-M10x1 | 8796958 | 972105 |
| | | |  |
| New Daily '96 Turbdaily '96 | - Tubo freno/Brake pipe - Lunghezza/Lenght mm. 383 - M16x1,5-M10x1-M10x1 | 93822492 8796934 | 972107 |
| | | |  |
| Daily Restyling | - Tubo freno/Brake pipe - Lunghezza/Lenght mm. 495 - M16x1,5-M10x1-M10x1 | 8796885 | 972106 |
| | | |  |
| Daily 2011/2014 | - Tubo freno/Brake pipe - Lunghezza/Lenght mm. 540 - M16x1,5-F10x1-M10x1 | 500330389 | 972096 |
| | | |  NEWS |

I riferimenti indicati non sono originali ma perfettamente intercambiabili. I codici originali e le case costruttrici sono indicati a puro titolo informativo
The details described are not original but perfectly interchangeable. The original references and manufacturer names are given for information purposes only.

EMMERRE

spare parts for trucks and trailers





IVECO**IMPIANTO IDRAULICO**
HYDRAULIC SYSTEM
SYSTEME HYDRAULIQUE
HYDRAULIKSYSTEM
ГИДРАВЛИЧЕСКАЯ СИСТЕМА
SISTEMA HIDRAULICO

| Emmerre | Adattabile a / <i>Adaptable to</i> | Dettagli / <i>Detail</i> | Applicazioni / <i>Applications</i> |
|---|------------------------------------|---|---|
| 972079 | 98409528 | - Tubo freno/ <i>Brake pipe</i> - Lunghezza/ <i>Lenght</i> mm. 393 - Ø 10 -F12x1,5 - Pneumatico/ <i>Pneumatic</i> | Eurocargo |
|  | | | |
| 972082 | 4722497 | - Tubo freno/ <i>Brake pipe</i> - Lunghezza/ <i>Lenght</i> mm. 542 - F16x1,5-F16x1,5 - Pneumatico/ <i>Pneumatic</i> - Anteriore/ <i>Front</i> | Eurocargo Turbotech |
|  | | | |
| 972085 | 4722637 | - Tubo freno/ <i>Brake pipe</i> - Lunghezza/ <i>Lenght</i> mm. 645 - F16x1,5-F16x1,5 - Pneumatico/ <i>Pneumatic</i> - Anteriore/ <i>Front</i> | Eurocargo Eurotech Turbostar Turbotech AP 160 |
|  | | | |
| 972093 | 4742729 | - Tubo freno/ <i>Brake pipe</i> - Lunghezza/ <i>Lenght</i> mm. 645 - F18x1,5-F18x1,5 - Pneumatico/ <i>Pneumatic</i> - Posteriore/ <i>Rear</i> | Eurocargo Turbostar Turbotech Eurotrakker Cursor Eurotech |
|  | | | |



IMPIANTO IDRAULICO
HYDRAULIC SYSTEM
SYSTEME HYDRAULIQUE
HYDRAULIKSYSTEM
ГИДРАВЛИЧЕСКАЯ СИСТЕМА
SISTEMA HIDRAULICO

EMMERRE
spare parts for trucks and trailers

IVECO

| Applicazioni / Applications | Dettagli / Detail | Adattabile a / Adaptable to | Emmerre |
|--|---|-----------------------------|---|
| Eurocargo Eurotech Cursor Eurostar Cursor Eurotrakker Turbostar Turbotech Stralis | - Tubo freno/ <i>Brake pipe</i> - Lunghezza/ <i>Lenght</i> mm. 560 - F18x1,5-F18x1,5 - Posteriore/ <i>Rear</i> | 42106884 | 972078 |
| | | |  |
| Eurocargo Eurotech Eurotrakker Cursor | - Tubo freno/ <i>Brake pipe</i> - Lunghezza/ <i>Lenght</i> mm. 460 - M26x1,5-M26x1,5 | 99447552 98455921 | 971111 |
| | | |  |
| Eurotrakker Stralis Cursor | - Tubo freno/ <i>Brake pipe</i> | 42106893 | 972103 |
| | | |  |
| New Daily Turbodaily | - Valvola più vie per sistemi frenanti pneumatici/ <i>Multi-way valve for pneumatic brake system</i> | 8796328 | 902298 |
| | | |  |

I riferimenti indicati non sono originali ma perfettamente intercambiabili. I codici originali e le case costruttrici sono indicati a puro titolo informativo
The details described are not original but perfectly interchangeable. The original references and manufacturer names are given for information purposes only.

| Emmerre | Adattabile a / <i>Adaptable to</i> | Dettagli / <i>Detail</i> | Applicazioni / <i>Applications</i> |
|---|------------------------------------|--|---|
| 964058 | -- | - Serbatoio liquido freno/ <i>Brake fluid tank</i> | Daily |
|  | | |  |
| | | | Connessione / <i>Connected:</i> 964011 |

MERCEDES

| Emmerre | Adattabile a / <i>Adaptable to</i> | Dettagli / <i>Detail</i> | Applicazioni / <i>Applications</i> |
|---|------------------------------------|---|------------------------------------|
| 964222 | 66648728 | - Cilindro freno/ <i>Brake cylinder</i> - Posteriore/ <i>Rear</i> - Ø mm. 25,40 | 100 BUS (631)D |
|  | | | |

IMPIANTO IDRAULICO
HYDRAULIC SYSTEM
SYSTEME HYDRAULIQUE
HYDRAULIKSYSTEM
ГИДРАВЛИЧЕСКАЯ СИСТЕМА
SISTEMA HIDRAULICO

EMMERRE
spare parts for trucks and trailers

NISSAN

| Applicazioni / Applications | Dettagli / Detail | Adattabile a / Adaptable to | Emmerre |
|-----------------------------|---|-----------------------------|--|
| Trade | - Cilindro freno/ <i>Brake cylinder</i> - Posteriore/ <i>Rear</i> - Ø mm. 25,40 | 06902174-0 | 964222 |
| | | |  |
| Cabstar | - Cilindro freno/ <i>Brake cylinder</i> - Posteriore/ <i>Rear</i> - Ø mm. 25,40 | 441009X125 | 964226 |
| | | |  |
| | | | |
| | | | |

Emmerre

Adattabile a / *Adaptable to*

Dettagli / *Detail*

Applicazioni / *Applications*

964404

5001847577

- Pompa freno/*Brake pump*
- Ø mm. 25,40

Mascott



RICERCA DI RIFERIMENTO EMMERRE SEARCH BY EMMERRE'S REFERENCE

| Emmerre | Adaptable | Page |
|---------|-----------|------|
| 101400 | IVECO | 306 |
| 101401 | IVECO | 306 |
| 101402 | IVECO | 306 |
| 101403 | IVECO | 307 |
| 101403 | MERCEDES | 322 |
| 101404 | IVECO | 307 |
| 101405 | IVECO | 308 |
| 101406 | IVECO | 310 |
| 101406 | MAN | 320 |
| 101406 | SAF | 328 |
| 101408 | IVECO | 316 |
| 101409 | IVECO | 318 |
| 101410 | IVECO | 318 |
| 101495 | IVECO | 309 |
| 101499 | IVECO | 319 |
| 101500 | IVECO | 308 |
| 101501 | IVECO | 307 |
| 101502 | IVECO | 309 |
| 101506 | IVECO | 311 |
| 101507 | IVECO | 311 |
| 101508 | IVECO | 311 |
| 101509 | IVECO | 310 |
| 101510 | IVECO | 310 |
| 101510 | SAF | 328 |
| 101511 | IVECO | 313 |
| 101512 | IVECO | 312 |
| 101513 | IVECO | 308 |
| 101514 | IVECO | 308 |
| 101517 | IVECO | 314 |
| 101518 | IVECO | 306 |
| 101519 | IVECO | 312 |
| 101521 | IVECO | 309 |
| 101522 | IVECO | 318 |
| 101523 | DAF | 305 |
| 101525 | CARDI | 304 |
| 101526 | SCANIA | 329 |
| 101527 | SCANIA | 329 |
| 101528 | IVECO | 307 |
| 101529 | SCANIA | 329 |
| 101532 | VOLVO | 333 |
| 101533 | VOLVO | 332 |
| 101534 | VOLVO | 332 |
| 101535 | VOLVO | 332 |
| 101536 | VOLVO | 332 |
| 101537 | RENAULT | 326 |
| 101537 | ROR | 327 |
| 101538 | ROR | 327 |
| 101539 | BPW | 303 |
| 101539 | SCHMITZ | 330 |
| 101540 | BPW | 303 |
| 101543 | BPW | 303 |
| 101544 | BPW | 303 |
| 101545 | IVECO | 316 |
| 101548 | ROR | 327 |
| 101550 | IVECO | 313 |
| 101551 | IVECO | 309 |
| 101552 | MAN | 320 |
| 101556 | MAN | 321 |
| 101559 | IVECO | 312 |
| 101565 | IVECO | 311 |
| 101566 | IVECO | 312 |
| 101567 | IVECO | 313 |
| 101568 | MERCEDES | 322 |
| 101569 | MERCEDES | 322 |
| 101581 | IVECO | 314 |

| Emmerre | Adaptable | Page |
|---------|-----------|------|
| 101583 | IVECO | 318 |
| 101587 | IVECO | 317 |
| 101588 | IVECO | 317 |
| 101588 | VOLVO | 333 |
| 101589 | MERCEDES | 323 |
| 101590 | SMB | 331 |
| 101593 | MERCEDES | 322 |
| 101598 | MERCEDES | 323 |
| 101600 | IVECO | 316 |
| 101603 | IVECO | 315 |
| 101605 | IVECO | 315 |
| 101605 | VOLVO | 333 |
| 101606 | IVECO | 315 |
| 101607 | IVECO | 316 |
| 101608 | IVECO | 314 |
| 101609 | IVECO | 314 |
| 101610 | IVECO | 317 |
| 101611 | IVECO | 317 |
| 101611 | MAN | 320 |
| 101611 | RENAULT | 325 |
| 101612 | IVECO | 313 |
| 101612 | NISSAN | 324 |
| 101612 | RENAULT | 325 |
| 101613 | IVECO | 315 |
| 101613 | MAN | 320 |
| 101613 | RENAULT | 325 |
| 101613 | VOLVO | 333 |
| 103647 | IVECO | 687 |
| 103648 | IVECO | 687 |
| 902298 | IVECO | 751 |
| 930935 | BPW | 361 |
| 930936 | BPW | 362 |
| 930937 | BPW | 362 |
| 930938 | BPW | 362 |
| 930939 | BPW | 362 |
| 930943 | BPW | 361 |
| 930944 | BPW | 361 |
| 930960 | BPW | 363 |
| 930961 | BPW | 363 |
| 930962 | BPW | 361 |
| 930967 | IVECO | 370 |
| 930968 | IVECO | 370 |
| 930971 | IVECO | 370 |
| 930974 | IVECO | 167 |
| 930976 | IVECO | 164 |
| 930977 | IVECO | 161 |
| 930979 | IVECO | 159 |
| 930980 | IVECO | 167 |
| 930982 | IVECO | 166 |
| 930986 | IVECO | 162 |
| 930989 | IVECO | 167 |
| 930993 | IVECO | 160 |
| 930994 | DAF | 225 |
| 930994 | IVECO | 234 |
| 930994 | MERCEDES | 245 |
| 930994 | SAF | 260 |
| 930994 | SCANIA | 262 |
| 930994 | VOLVO | 273 |
| 930995 | IVECO | 234 |
| 930995 | MERCEDES | 245 |
| 930996 | DAF | 225 |
| 930996 | IVECO | 233 |
| 930996 | MAN | 240 |
| 930996 | MERCEDES | 246 |
| 930997 | IVECO | 236 |

| Emmerre | Adaptable | Page |
|---------|-----------|------|
| 930998 | IVECO | 231 |
| 930999 | IVECO | 156 |
| 931000 | IVECO | 152 |
| 931001 | IVECO | 152 |
| 931002 | IVECO | 155 |
| 931003 | IVECO | 150 |
| 931005 | IVECO | 150 |
| 931006 | IVECO | 150 |
| 931007 | IVECO | 150 |
| 931008 | IVECO | 151 |
| 931009 | IVECO | 228 |
| 931010 | IVECO | 228 |
| 931011 | BPW | 219 |
| 931011 | DAF | 225 |
| 931011 | IVECO | 229 |
| 931011 | MAN | 238 |
| 931011 | MERCEDES | 243 |
| 931011 | RENAULT | 250 |
| 931011 | SCANIA | 262 |
| 931011 | VOLVO | 269 |
| 931012 | IVECO | 229 |
| 931012 | MAN | 238 |
| 931012 | MERCEDES | 244 |
| 931012 | RENAULT | 250 |
| 931012 | SCANIA | 264 |
| 931012 | VOLVO | 269 |
| 931013 | IVECO | 370 |
| 931014 | IVECO | 228 |
| 931015 | IVECO | 229 |
| 931017 | IVECO | 153 |
| 931018 | IVECO | 230 |
| 931019 | IVECO | 154 |
| 931020 | IVECO | 229 |
| 931021 | IVECO | 230 |
| 931022 | IVECO | 230 |
| 931023 | IVECO | 166 |
| 931025 | IVECO | 155 |
| 931029 | IVECO | 159 |
| 931030 | IVECO | 165 |
| 931031 | IVECO | 165 |
| 931032 | IVECO | 165 |
| 931033 | IVECO | 160 |
| 931034 | IVECO | 164 |
| 931035 | IVECO | 160 |
| 931036 | IVECO | 163 |
| 931037 | IVECO | 163 |
| 931038 | IVECO | 167 |
| 931039 | IVECO | 159 |
| 931040 | IVECO | 165 |
| 931041 | IVECO | 161 |
| 931042 | IVECO | 168 |
| 931043 | IVECO | 162 |
| 931044 | IVECO | 166 |
| 931046 | IVECO | 160 |
| 931048 | IVECO | 161 |
| 931049 | IVECO | 164 |
| 931050 | IVECO | 156 |
| 931051 | DAF | 222 |
| 931052 | DAF | 222 |
| 931053 | DAF | 223 |
| 931053 | IVECO | 228 |
| 931053 | MAN | 238 |
| 931053 | MERCEDES | 243 |
| 931053 | RENAULT | 252 |
| 931053 | SCANIA | 263 |

I riferimenti indicati non sono originali ma perfettamente intercambiabili. I codici originali e le case costruttrici sono indicati a puro titolo informativo
The details described are not original but perfectly interchangeable. The original references and manufacturer names are given for information purposes only.

| Emmerre | Adaptable | Page |
|---------|-----------|------|
| 931053 | VOLVO | 269 |
| 931054 | IVECO | 231 |
| 931055 | IVECO | 231 |
| 931056 | IVECO | 232 |
| 931056 | MERCEDES | 246 |
| 931056 | RENAULT | 252 |
| 931056 | SAF | 260 |
| 931057 | DAF | 223 |
| 931057 | IVECO | 235 |
| 931057 | ROR | 256 |
| 931057 | VANHOOL | 268 |
| 931058 | IVECO | 282 |
| 931059 | MAN | 239 |
| 931060 | MAN | 240 |
| 931061 | IVECO | 236 |
| 931061 | MAN | 239 |
| 931061 | SCANIA | 264 |
| 931062 | MAN | 169 |
| 931064 | IVECO | 235 |
| 931068 | RENAULT | 179 |
| 931068 | VOLVO | 211 |
| 931070 | IVECO | 166 |
| 931071 | IVECO | 157 |
| 931072 | MAN | 170 |
| 931073 | IVECO | 158 |
| 931074 | BPW | 220 |
| 931074 | MAN | 239 |
| 931074 | MERCEDES | 244 |
| 931074 | RENAULT | 250 |
| 931074 | ROR | 255 |
| 931074 | SAF | 258 |
| 931074 | SCHMITZ | 266 |
| 931074 | VOLVO | 270 |
| 931075 | DAF | 224 |
| 931075 | RENAULT | 251 |
| 931075 | ROR | 255 |
| 931075 | SAF | 259 |
| 931075 | SCANIA | 263 |
| 931075 | SCHMITZ | 267 |
| 931075 | VOLVO | 270 |
| 931076 | ROR | 255 |
| 931077 | DAF | 223 |
| 931078 | IVECO | 235 |
| 931078 | ROR | 256 |
| 931078 | VANHOOL | 268 |
| 931079 | IVECO | 230 |
| 931080 | DAF | 222 |
| 931082 | IVECO | 156 |
| 931083 | DAF | 226 |
| 931083 | IVECO | 235 |
| 931083 | MAN | 241 |
| 931083 | MERCEDES | 245 |
| 931083 | RENAULT | 252 |
| 931083 | ROR | 257 |
| 931083 | SAF | 260 |
| 931083 | VOLVO | 273 |
| 931084 | IVECO | 161 |
| 931086 | DAF | 226 |
| 931086 | IVECO | 232 |
| 931086 | MAN | 239 |
| 931086 | MERCEDES | 243 |
| 931086 | VOLVO | 271 |
| 931087 | IVECO | 233 |
| 931087 | MAN | 240 |
| 931087 | MERCEDES | 246 |

| Emmerre | Adaptable | Page |
|---------|-----------|------|
| 931087 | ROR | 256 |
| 931087 | SCANIA | 262 |
| 931087 | VOLVO | 273 |
| 931089 | IVECO | 234 |
| 931089 | MERCEDES | 246 |
| 931090 | IVECO | 233 |
| 931091 | DAF | 225 |
| 931091 | IVECO | 233 |
| 931091 | MAN | 240 |
| 931091 | VOLVO | 272 |
| 931092 | MERCEDES | 248 |
| 931093 | DAF | 223 |
| 931094 | IVECO | 236 |
| 931094 | SAF | 259 |
| 931095 | IVECO | 163 |
| 931096 | RENAULT | 179 |
| 931097 | RENAULT | 179 |
| 931098 | IVECO | 368 |
| 931099 | BPW | 219 |
| 931099 | IVECO | 237 |
| 931099 | MAN | 241 |
| 931099 | MERCEDES | 245 |
| 931099 | RENAULT | 254 |
| 931099 | SAF | 260 |
| 931099 | SCANIA | 264 |
| 931099 | VOLVO | 275 |
| 931100 | MAN | 169 |
| 931101 | MAN | 170 |
| 931102 | RENAULT | 252 |
| 931103 | RENAULT | 251 |
| 931104 | IVECO | 163 |
| 931105 | IVECO | 158 |
| 931106 | IVECO | 158 |
| 931107 | RENAULT | 183 |
| 931107 | VOLVO | 217 |
| 931108 | MAN | 241 |
| 931108 | MERCEDES | 247 |
| 931108 | VOLVO | 274 |
| 931109 | IVECO | 157 |
| 931110 | MAN | 170 |
| 931112 | MAN | 170 |
| 931114 | BPW | 363 |
| 931115 | IVECO | 153 |
| 931116 | IVECO | 152 |
| 931117 | IVECO | 154 |
| 931118 | IVECO | 155 |
| 931119 | IVECO | 156 |
| 931120 | RENAULT | 374 |
| 931120 | VOLVO | 382 |
| 931121 | RENAULT | 374 |
| 931121 | VOLVO | 382 |
| 931122 | VOLVO | 382 |
| 931123 | DAF | 364 |
| 931124 | MERCEDES | 372 |
| 931125 | DAF | 364 |
| 931126 | SCANIA | 380 |
| 931127 | DAF | 364 |
| 931128 | MERCEDES | 372 |
| 931129 | RENAULT | 374 |
| 931129 | VOLVO | 382 |
| 931130 | MERCEDES | 372 |
| 931131 | BPW | 363 |
| 931132 | SAF | 378 |
| 931133 | MERCEDES | 372 |
| 931135 | MERCEDES | 373 |

| Emmerre | Adaptable | Page |
|---------|-----------|------|
| 931136 | MERCEDES | 373 |
| 931137 | IVECO | 153 |
| 931138 | IVECO | 152 |
| 931139 | IVECO | 151 |
| 931140 | IVECO | 157 |
| 931141 | IVECO | 157 |
| 931142 | IVECO | 151 |
| 931143 | IVECO | 151 |
| 931144 | IVECO | 153 |
| 931145 | IVECO | 158 |
| 931146 | IVECO | 162 |
| 931147 | DAF | 365 |
| 931148 | MERCEDES | 373 |
| 931149 | SAF | 378 |
| 931150 | DAF | 364 |
| 931152 | SAF | 378 |
| 931153 | MAN | 169 |
| 931154 | MAN | 171 |
| 931155 | MAN | 171 |
| 931156 | MAN | 169 |
| 931157 | MAN | 371 |
| 931158 | MAN | 371 |
| 931158 | MERCEDES | 373 |
| 931159 | SAF | 376 |
| 931160 | IVECO | 231 |
| 931161 | SAF | 376 |
| 931162 | DAF | 227 |
| 931162 | IVECO | 236 |
| 931162 | MAN | 242 |
| 931162 | MERCEDES | 248 |
| 931162 | RENAULT | 253 |
| 931162 | SCANIA | 265 |
| 931162 | VOLVO | 275 |
| 931163 | SCANIA | 380 |
| 931164 | SCANIA | 380 |
| 931165 | SCANIA | 380 |
| 931168 | IVECO | 154 |
| 931172 | IVECO | 159 |
| 931174 | IVECO | 237 |
| 931180 | SAF | 378 |
| 931181 | SAF | 379 |
| 931200 | CARDI | 144 |
| 931205 | IVECO | 369 |
| 931206 | IVECO | 369 |
| 931207 | IVECO | 369 |
| 931215 | IVECO | 162 |
| 931216 | IVECO | 164 |
| 931251 | O-CAVA | 178 |
| 931300 | VIBERTI | 210 |
| 931317 | IVECO | 310 |
| 931317 | RENAULT | 325 |
| 931369 | BPW | 138 |
| 931370 | BPW | 141 |
| 931371 | BPW | 141 |
| 931372 | BPW | 141 |
| 931373 | BPW | 137 |
| 931374 | BPW | 140 |
| 931375 | BPW | 132 |
| 931376 | BPW | 133 |
| 931377 | BPW | 134 |
| 931378 | DAF | 227 |
| 931378 | MAN | 242 |
| 931378 | MERCEDES | 247 |
| 931380 | MAN | 242 |
| 931380 | MERCEDES | 247 |

I riferimenti indicati non sono originali ma perfettamente intercambiabili. I codici originali e le case costruttrici sono indicati a puro titolo informativo
The details described are not original but perfectly interchangeable. The original references and manufacturer names are given for information purposes only.

RICERCA DI RIFERIMENTO EMMERRE SEARCH BY EMMERRE'S REFERENCE

| Emmerre | Adaptable | Page |
|---------|-----------|------|
| 931380 | RENAULT | 253 |
| 931380 | VOLVO | 274 |
| 931381 | BPW | 136 |
| 931382 | BPW | 139 |
| 931383 | BPW | 139 |
| 931385 | BPW | 143 |
| 931386 | BPW | 140 |
| 931387 | BPW | 221 |
| 931388 | BPW | 220 |
| 931389 | BPW | 221 |
| 931390 | BPW | 221 |
| 931391 | BPW | 143 |
| 931392 | BPW | 140 |
| 931393 | BPW | 138 |
| 931394 | BPW | 219 |
| 931394 | DAF | 226 |
| 931394 | IVECO | 237 |
| 931394 | MAN | 241 |
| 931394 | MERCEDES | 244 |
| 931394 | ROR | 255 |
| 931394 | SCANIA | 263 |
| 931394 | SCHMITZ | 266 |
| 931395 | BPW | 220 |
| 931395 | IVECO | 232 |
| 931395 | SAF | 258 |
| 931395 | SCHMITZ | 266 |
| 931396 | BPW | 220 |
| 931396 | DAF | 222 |
| 931396 | IVECO | 234 |
| 931396 | MAN | 238 |
| 931396 | MERCEDES | 248 |
| 931396 | ROR | 256 |
| 931396 | SCHMITZ | 266 |
| 931396 | VOLVO | 273 |
| 931397 | MERCEDES | 247 |
| 931398 | BPW | 135 |
| 931399 | BPW | 137 |
| 931400 | BPW | 134 |
| 931401 | BPW | 128 |
| 931402 | BPW | 129 |
| 931403 | BPW | 130 |
| 931404 | BPW | 131 |
| 931405 | BPW | 133 |
| 931406 | BPW | 127 |
| 931408 | BPW | 127 |
| 931409 | BPW | 134 |
| 931410 | BPW | 128 |
| 931411 | BPW | 129 |
| 931412 | BPW | 130 |
| 931413 | BPW | 131 |
| 931414 | BPW | 132 |
| 931415 | BPW | 133 |
| 931416 | DAF | 224 |
| 931416 | VOLVO | 272 |
| 931417 | DAF | 224 |
| 931417 | VOLO | 271 |
| 931418 | BPW | 132 |
| 931419 | DAF | 224 |
| 931419 | VOLVO | 272 |
| 931420 | IVECO | 232 |
| 931420 | ROR | 257 |
| 931420 | VOLVO | 271 |
| 931421 | BPW | 135 |
| 931422 | RENAULT | 181 |
| 931422 | VOLVO | 211 |

| Emmerre | Adaptable | Page |
|---------|-----------|------|
| 931423 | RENAULT | 251 |
| 931423 | VOLVO | 271 |
| 931424 | RENAULT | 251 |
| 931424 | VOLVO | 270 |
| 931425 | RENAULT | 250 |
| 931425 | VOLVO | 270 |
| 931426 | RENAULT | 182 |
| 931426 | VOLVO | 214 |
| 931427 | RENAULT | 180 |
| 931427 | VOLVO | 212 |
| 931429 | VOLVO | 212 |
| 931430 | SCANIA | 262 |
| 931430 | VOLVO | 269 |
| 931431 | VOLVO | 214 |
| 931432 | VOLVO | 213 |
| 931433 | RENAULT | 180 |
| 931433 | VOLVO | 213 |
| 931434 | BPW | 136 |
| 931435 | RENAULT | 181 |
| 931436 | RENAULT | 181 |
| 931436 | VOLVO | 215 |
| 931437 | BPW | 136 |
| 931438 | RENAULT | 182 |
| 931438 | VOLVO | 214 |
| 931439 | VOLVO | 214 |
| 931440 | RENAULT | 180 |
| 931440 | VOLVO | 212 |
| 931441 | VOLVO | 212 |
| 931442 | VOLVO | 213 |
| 931443 | RENAULT | 180 |
| 931443 | VOLVO | 213 |
| 931445 | VOLVO | 218 |
| 931448 | RENAULT | 182 |
| 931448 | VOLVO | 215 |
| 931449 | VOLVO | 216 |
| 931450 | VOLVO | 217 |
| 931451 | VOLVO | 217 |
| 931452 | VOLVO | 216 |
| 931453 | VOLVO | 216 |
| 931455 | VOLVO | 211 |
| 931458 | BPW | 127 |
| 931459 | BPW | 129 |
| 931460 | BPW | 130 |
| 931461 | BPW | 131 |
| 931462 | BPW | 137 |
| 931463 | BPW | 135 |
| 931464 | BPW | 128 |
| 931465 | BPW | 138 |
| 931466 | BPW | 143 |
| 931471 | RENAULT | 181 |
| 931471 | VOLVO | 215 |
| 931472 | RENAULT | 183 |
| 931472 | VOLVO | 217 |
| 931475 | VOLVO | 216 |
| 931479 | BPW | 144 |
| 931480 | BPW | 144 |
| 931481 | BPW | 142 |
| 931482 | BPW | 142 |
| 931483 | BPW | 143 |
| 931484 | BPW | 142 |
| 931485 | BPW | 144 |
| 931486 | RENAULT | 182 |
| 931486 | VOLVO | 215 |
| 931487 | DAF | 148 |
| 931487 | RENAULT | 179 |

| Emmerre | Adaptable | Page |
|----------|-----------|------|
| 931487 | VOLVO | 211 |
| 931488 | IVECO | 237 |
| 931489 | BPW | 219 |
| 931492 | BPW | 139 |
| 931500 | ROR | 186 |
| 931500/N | ROR | 186 |
| 931501 | ROR | 184 |
| 931501/N | ROR | 184 |
| 931502 | ROR | 185 |
| 931502/N | ROR | 185 |
| 931503 | ROR | 189 |
| 931503/N | ROR | 189 |
| 931504 | ROR | 187 |
| 931504/N | ROR | 187 |
| 931505 | ROR | 192 |
| 931505/N | ROR | 192 |
| 931506 | ROR | 193 |
| 931506/N | ROR | 193 |
| 931507 | ROR | 188 |
| 931507/N | ROR | 188 |
| 931508 | ROR | 190 |
| 931508/N | ROR | 190 |
| 931510 | IVECO | 367 |
| 931511 | IVECO | 154 |
| 931512 | IVECO | 367 |
| 931513 | IVECO | 366 |
| 931514 | IVECO | 366 |
| 931515 | IVECO | 366 |
| 931516 | IVECO | 366 |
| 931517 | IVECO | 369 |
| 931521 | ROR | 184 |
| 931522 | ROR | 185 |
| 931523 | ROR | 188 |
| 931524 | ROR | 189 |
| 931525 | ROR | 186 |
| 931526 | ROR | 187 |
| 931527 | ROR | 193 |
| 931528 | ROR | 190 |
| 931530 | ROR | 191 |
| 931530/N | ROR | 191 |
| 931531 | ROR | 191 |
| 931532 | ROR | 192 |
| 931534 | ROR | 375 |
| 931535 | ROR | 375 |
| 931536 | ROR | 375 |
| 931537 | ROR | 375 |
| 931594 | SAF | 261 |
| 931596 | SAF | 200 |
| 931597 | SAF | 199 |
| 931598 | SAF | 200 |
| 931599 | SAF | 194 |
| 931600 | SAF | 194 |
| 931600 | SCHMITZ | 208 |
| 931600.4 | SAF | 377 |
| 931600.4 | SCHMITZ | 381 |
| 931600.5 | SAF | 296 |
| 931600.5 | SCHMITZ | 298 |
| 931604 | SAF | 197 |
| 931605 | SAF | 194 |
| 931606 | SAF | 195 |
| 931606/N | SAF | 195 |
| 931607 | SAF | 376 |
| 931608 | SAF | 259 |
| 931609 | DAF | 226 |
| 931609 | SAF | 258 |

I riferimenti indicati non sono originali ma perfettamente intercambiabili. I codici originali e le case costruttrici sono indicati a puro titolo informativo
The details described are not original but perfectly interchangeable. The original references and manufacturer names are given for information purposes only.

| Emmerre | Adaptable | Page |
|----------|-----------|------|
| 931610 | SAF | 258 |
| 931611 | SAF | 259 |
| 931612 | SAF | 196 |
| 931613 | SAF | 196 |
| 931614 | SAF | 198 |
| 931615 | SAF | 197 |
| 931616 | SAF | 195 |
| 931617 | FRUEHAUF | 149 |
| 931617 | SAF | 194 |
| 931618 | FRUEHAUF | 149 |
| 931619 | DAF | 148 |
| 931619 | FRUEHAUF | 149 |
| 931621 | SMB | 209 |
| 931622 | SAF | 377 |
| 931623 | SAF | 377 |
| 931624 | SAF | 376 |
| 931625 | SAF | 377 |
| 931626 | SCANIA | 381 |
| 931630 | SAF | 196 |
| 931631 | SAF | 196 |
| 931632 | SAF | 198 |
| 931633 | SAF | 197 |
| 931634 | SAF | 200 |
| 931635 | SAF | 199 |
| 931636 | SAF | 200 |
| 931637 | SAF | 201 |
| 931638 | SAF | 201 |
| 931701 | NISSAN | 177 |
| 931749 | DAF | 146 |
| 931750 | DAF | 145 |
| 931750.3 | DAF | 365 |
| 931751 | DAF | 147 |
| 931752 | DAF | 147 |
| 931753 | DAF | 145 |
| 931754 | DAF | 146 |
| 931755 | DAF | 146 |
| 931800 | SCANIA | 203 |
| 931801 | SCANIA | 202 |
| 931802 | SCANIA | 204 |
| 931803 | SCANIA | 205 |
| 931804 | SCANIA | 203 |
| 931805 | SCANIA | 205 |
| 931806 | SCANIA | 206 |
| 931807 | MERCEDES | 175 |
| 931808 | SCANIA | 202 |
| 931809 | SCANIA | 204 |
| 931810 | MERCEDES | 173 |
| 931811 | MERCEDES | 175 |
| 931812 | MERCEDES | 249 |
| 931812 | RENAULT | 253 |
| 931812 | SAF | 261 |
| 931812 | SCANIA | 264 |
| 931812 | VOLVO | 274 |
| 931813 | MERCEDES | 249 |
| 931813 | VOLVO | 274 |
| 931814 | MERCEDES | 174 |
| 931815 | MERCEDES | 172 |
| 931816 | MERCEDES | 243 |
| 931817 | MERCEDES | 172 |
| 931818 | SCANIA | 263 |
| 931823 | MERCEDES | 174 |
| 931824 | MERCEDES | 172 |
| 931825 | MERCEDES | 173 |
| 931827 | MERCEDES | 176 |
| 931827.1 | MERCEDES | 290 |

| Emmerre | Adaptable | Page |
|---------|-----------|------|
| 931828 | MERCEDES | 173 |
| 931829 | MERCEDES | 173 |
| 931830 | MERCEDES | 244 |
| 931830 | VOLVO | 272 |
| 931831 | MERCEDES | 172 |
| 931832 | MERCEDES | 176 |
| 931833 | MERCEDES | 175 |
| 931835 | MERCEDES | 174 |
| 931836 | MERCEDES | 176 |
| 931838 | SCANIA | 202 |
| 931839 | SCANIA | 204 |
| 931840 | MERCEDES | 174 |
| 931841 | SCANIA | 207 |
| 931842 | SCANIA | 206 |
| 931843 | SCANIA | 203 |
| 931844 | SCANIA | 205 |
| 931845 | SCANIA | 207 |
| 931846 | SCANIA | 207 |
| 931847 | SCANIA | 206 |
| 931850 | DAF | 145 |
| 931851 | DAF | 147 |
| 931852 | DAF | 147 |
| 931853 | DAF | 145 |
| 931855 | DAF | 146 |
| 931868 | MERCEDES | 175 |
| 931869 | SAF | 201 |
| 931870 | SAF | 201 |
| 931979 | MAN | 242 |
| 931979 | MERCEDES | 248 |
| 931979 | RENAULT | 253 |
| 932000 | DAF | 91 |
| 932001 | DAF | 91 |
| 932004 | DAF | 91 |
| 932006 | DAF | 91 |
| 932100 | IVECO | 93 |
| 932101 | IVECO | 93 |
| 932102 | IVECO | 95 |
| 932103 | IVECO | 93 |
| 932104 | IVECO | 93 |
| 932105 | IVECO | 94 |
| 932106 | IVECO | 96 |
| 932107 | IVECO | 96 |
| 932108 | IVECO | 95 |
| 932109 | IVECO | 95 |
| 932110 | IVECO | 97 |
| 932111 | IVECO | 96 |
| 932112 | IVECO | 97 |
| 932113 | IVECO | 97 |
| 932114 | IVECO | 97 |
| 932115 | IVECO | 98 |
| 932116 | IVECO | 98 |
| 932117 | IVECO | 99 |
| 932118 | IVECO | 100 |
| 932119 | IVECO | 99 |
| 932120 | IVECO | 99 |
| 932121 | IVECO | 99 |
| 932122 | IVECO | 95 |
| 932123 | IVECO | 94 |
| 932124 | IVECO | 92 |
| 932126 | IVECO | 94 |
| 932128 | IVECO | 92 |
| 932130 | IVECO | 94 |
| 932132 | IVECO | 98 |
| 932133 | IVECO | 96 |
| 932134 | IVECO | 98 |

| Emmerre | Adaptable | Page |
|---------|-----------|------|
| 932200 | MAN | 101 |
| 932201 | MAN | 101 |
| 932203 | MAN | 101 |
| 932300 | MERCEDES | 103 |
| 932301 | MERCEDES | 103 |
| 932302 | MERCEDES | 103 |
| 932302 | RENAULT | 108 |
| 932303 | MAN | 102 |
| 932303 | MERCEDES | 103 |
| 932303 | RENAULT | 107 |
| 932304 | MERCEDES | 104 |
| 932305 | MAN | 102 |
| 932305 | MERCEDES | 104 |
| 932305 | RENAULT | 107 |
| 932306 | MERCEDES | 104 |
| 932307 | MERCEDES | 104 |
| 932308 | MAN | 101 |
| 932308 | MERCEDES | 105 |
| 932308 | RENAULT | 108 |
| 932309 | MERCEDES | 105 |
| 932400 | RENAULT | 107 |
| 932401 | RENAULT | 107 |
| 932402 | RENAULT | 108 |
| 932404 | RENAULT | 109 |
| 932500 | SCANIA | 114 |
| 932501 | SCANIA | 114 |
| 932502 | SCANIA | 114 |
| 932503 | SCANIA | 114 |
| 932504 | SCANIA | 115 |
| 932600 | VOLVO | 122 |
| 932601 | RENAULT | 108 |
| 932601 | VOLVO | 122 |
| 932602 | VOLVO | 122 |
| 932603 | VOLVO | 123 |
| 932604 | VOLVO | 123 |
| 932605 | VOLVO | 123 |
| 932606 | VOLVO | 124 |
| 932607 | VOLVO | 124 |
| 932608 | VOLVO | 124 |
| 932609 | VOLVO | 124 |
| 932610 | VOLVO | 123 |
| 932614 | VOLVO | 125 |
| 932615 | VOLVO | 122 |
| 932700 | SMB | 116 |
| 932701 | SMB | 116 |
| 932748 | CALABRESE | 90 |
| 932750 | CARDI | 90 |
| 932751 | CARDI | 90 |
| 932800 | BPW | 85 |
| 932800 | VIBERTI | 118 |
| 932801 | BPW | 85 |
| 932801 | VIBERTI | 118 |
| 932802 | BPW | 85 |
| 932802 | SAF | 112 |
| 932802 | VIBERTI | 118 |
| 932803 | BPW | 85 |
| 932803 | VIBERTI | 118 |
| 932804 | BPW | 86 |
| 932805 | BPW | 86 |
| 932805 | VIBERTI | 119 |
| 932806 | BPW | 86 |
| 932806 | VIBERTI | 119 |
| 932807 | BPW | 86 |
| 932807 | VIBERTI | 119 |
| 932808 | BPW | 87 |

RICERCA DI RIFERIMENTO EMMERRE SEARCH BY EMMERRE'S REFERENCE

| Emmerre | Adaptable | Page |
|---------|-----------|------|
| 932808 | VIBERTI | 119 |
| 932809 | BPW | 87 |
| 932809 | VIBERTI | 120 |
| 932810 | BPW | 87 |
| 932810 | VIBERTI | 120 |
| 932811 | BPW | 88 |
| 932811 | VIBERTI | 120 |
| 932814 | BPW | 89 |
| 932814 | VIBERTI | 121 |
| 932815 | BPW | 88 |
| 932816 | BPW | 88 |
| 932817 | BPW | 87 |
| 932818 | BPW | 88 |
| 932818 | VIBERTI | 120 |
| 932819 | BPW | 89 |
| 932850 | SAF | 113 |
| 932850 | TRAILOR | 117 |
| 932900 | ROR | 110 |
| 932901 | ROR | 110 |
| 932902 | ROR | 110 |
| 932903 | ROR | 110 |
| 932904 | ROR | 111 |
| 932950 | SAF | 112 |
| 932951 | SAF | 112 |
| 932952 | SAF | 112 |
| 932953 | SAF | 113 |
| 932954 | SAF | 113 |
| 933012 | IVECO | 280 |
| 933016 | IVECO | 283 |
| 933017 | IVECO | 283 |
| 933104 | BPW | 277 |
| 933104 | IVECO | 286 |
| 933104 | MAN | 287 |
| 933104 | MERCEDES | 290 |
| 933111 | DAF | 279 |
| 933111 | IVECO | 285 |
| 933111 | MERCEDES | 290 |
| 933112 | DAF | 279 |
| 933112 | IVECO | 285 |
| 933112 | MAN | 287 |
| 933112 | MERCEDES | 289 |
| 933112 | SAF | 296 |
| 933115 | IVECO | 281 |
| 933118 | DAF | 278 |
| 933118 | IVECO | 284 |
| 933119 | IVECO | 284 |
| 933119 | ROR | 294 |
| 933119 | SAF | 295 |
| 933121 | IVECO | 285 |
| 933121 | VOLVO | 301 |
| 933122 | IVECO | 283 |
| 933126 | IVECO | 284 |
| 933127 | IVECO | 284 |
| 933128 | RENAULT | 292 |
| 933129 | SCANIA | 297 |
| 933140 | ROR | 294 |
| 951026 | VOLVO | 300 |
| 951027 | VOLVO | 300 |
| 951032 | RENAULT | 293 |
| 951032 | VOLVO | 300 |
| 951037 | RENAULT | 293 |
| 951037 | VOLVO | 300 |
| 951059 | IVECO | 281 |
| 951060 | IVECO | 280 |
| 951063 | IVECO | 280 |

| Emmerre | Adaptable | Page |
|----------|-----------|------|
| 951064 | IVECO | 282 |
| 951065 | IVECO | 281 |
| 951066 | IVECO | 280 |
| 951067 | IVECO | 283 |
| 951068 | IVECO | 282 |
| 951069 | IVECO | 282 |
| 951070 | IVECO | 281 |
| 951071 | RENAULT | 292 |
| 951071 | VOLVO | 299 |
| 951072 | VOLVO | 301 |
| 951073 | RENAULT | 293 |
| 951073 | VOLVO | 301 |
| 951074 | RENAULT | 292 |
| 951074 | VOLVO | 299 |
| 951075 | VOLVO | 299 |
| 951076 | DAF | 278 |
| 951077 | DAF | 278 |
| 951078 | VOLVO | 299 |
| 951079 | RENAULT | 292 |
| 951080 | RENAULT | 293 |
| 951082 | MAN | 287 |
| 951082 | MERCEDES | 290 |
| 951085 | MERCEDES | 291 |
| 951086 | MERCEDES | 291 |
| 951088 | SCANIA | 297 |
| 951089 | SCANIA | 297 |
| 951090 | SCANIA | 298 |
| 951091 | DAF | 278 |
| 951092 | DAF | 279 |
| 951097 | SCANIA | 297 |
| 951098 | MAN | 287 |
| 951098 | MERCEDES | 289 |
| 951100 | SAF | 295 |
| 951101 | SAF | 296 |
| 951102 | SAF | 296 |
| 951103 | BPW | 277 |
| 951104 | BPW | 277 |
| 951105 | BPW | 277 |
| 951120 | IVECO | 285 |
| 951130 | MAN | 288 |
| 951131 | MAN | 288 |
| 951140 | MERCEDES | 289 |
| 951141 | MERCEDES | 289 |
| 951150 | SAF | 295 |
| 951151 | SAF | 295 |
| 953200 | IVECO | 368 |
| 953201 | IVECO | 368 |
| 953202 | IVECO | 368 |
| 960002 | IVECO | 31 |
| 960002S | IVECO | 31 |
| 960003 | IVECO | 31 |
| 960003S | IVECO | 31 |
| 960004 | IVECO | 597 |
| 960005 | IVECO | 597 |
| 960007 | IVECO | 31 |
| 960007S | IVECO | 31 |
| 960009 | IVECO | 597 |
| 960011E3 | IVECO BUS | 415 |
| 960013 | IVECO | 595 |
| 960014 | IVECO | 596 |
| 960015 | IVECO | 596 |
| 960016 | IVECO | 591 |
| 960017 | IVECO | 588 |
| 960018 | SCHMITZ | 75 |
| 960019 | IVECO | 30 |

| Emmerre | Adaptable | Page |
|----------|-----------|------|
| 960019S | IVECO | 30 |
| 960020 | IVECO | 27 |
| 960020S | IVECO | 27 |
| 960021 | IVECO | 20 |
| 960021S | IVECO | 20 |
| 960022 | IVECO | 20 |
| 960022S | IVECO | 20 |
| 960023 | IVECO | 20 |
| 960023S | IVECO | 20 |
| 960024 | IVECO | 25 |
| 960024S | IVECO | 25 |
| 960026 | IVECO | 589 |
| 960027 | IVECO | 92 |
| 960028 | IVECO | 92 |
| 960029E3 | IVECO | 411 |
| 960031 | SCHMITZ | 75 |
| 960032 | IVECO | 25 |
| 960032S | IVECO | 25 |
| 960033 | IVECO | 29 |
| 960033S | IVECO | 29 |
| 960034 | IVECO | 29 |
| 960036 | IVECO | 25 |
| 960036S | IVECO | 25 |
| 960037 | IVECO | 25 |
| 960037S | IVECO | 25 |
| 960038 | IVECO | 30 |
| 960038S | IVECO | 30 |
| 960039 | IVECO | 20 |
| 960039S | IVECO | 20 |
| 960048 | IVECO | 26 |
| 960048S | IVECO | 26 |
| 960049 | IVECO | 26 |
| 960049S | IVECO | 26 |
| 960050 | IVECO | 21 |
| 960050S | IVECO | 21 |
| 960051 | IVECO | 22 |
| 960051S | IVECO | 22 |
| 960052 | SCANIA | 74 |
| 960053 | IVECO | 29 |
| 960053S | IVECO | 29 |
| 960054 | NISSAN | 53 |
| 960055 | NISSAN | 49 |
| 960056 | NISSAN | 49 |
| 960057 | NISSAN | 51 |
| 960058 | NISSAN | 51 |
| 960058 | RENAULT | 57 |
| 960059 | NISSAN | 50 |
| 960062 | NISSAN | 53 |
| 960068 | IVECO | 26 |
| 960068S | IVECO | 26 |
| 960073 | MERCEDES | 43 |
| 960074 | MERCEDES | 44 |
| 960077 | IVECO | 597 |
| 960078 | IVECO | 600 |
| 960079 | IVECO | 601 |
| 960080 | IVECO | 601 |
| 960081 | IVECO | 603 |
| 960082 | IVECO | 596 |
| 960083 | IVECO | 601 |
| 960083 | ROR | 613 |
| 960084 | IVECO | 601 |
| 960085 | IVECO | 605 |
| 960086 | IVECO | 605 |
| 960087 | IVECO | 605 |
| 960088 | IVECO | 605 |

I riferimenti indicati non sono originali ma perfettamente intercambiabili. I codici originali e le case costruttrici sono indicati a puro titolo informativo
The details described are not original but perfectly interchangeable. The original references and manufacturer names are given for information purposes only.

| Emmerre | Adaptable | Page |
|----------|-----------|------|
| 960089 | IVECO | 606 |
| 960090 | IVECO | 588 |
| 960091 | IVECO | 588 |
| 960100 | MAN | 37 |
| 960102E3 | SAF | 447 |
| 960104 | IVECO | 27 |
| 960104S | IVECO | 27 |
| 960107 | IVECO | 22 |
| 960107S | IVECO | 22 |
| 960108 | IVECO | 22 |
| 960108S | IVECO | 22 |
| 960110 | ROR | 68 |
| 960111 | IVECO | 29 |
| 960111S | IVECO | 29 |
| 960112 | IVECO | 606 |
| 960119 | ROR | 68 |
| 960124 | MERCEDES | 42 |
| 960125 | MERCEDES | 42 |
| 960128 | SAF | 73 |
| 960129 | VOLVO | 80 |
| 960140 | RENAULT | 66 |
| 960141 | FORD | 15 |
| 960142 | FORD | 15 |
| 960143 | FORD | 15 |
| 960144 | FORD | 16 |
| 960157 | ROR | 614 |
| 960157 | VOLVO | 620 |
| 960164 | DAF | 522 |
| 960164 | SCANIA | 549 |
| 960167 | RENAULT | 544 |
| 960171 | FIAT | 393 |
| 960173 | FIAT | 393 |
| 960174 | FIAT | 11 |
| 960175 | FIAT | 11 |
| 960176 | FIAT | 11 |
| 960178 | FIAT | 11 |
| 960181E3 | FIAT | 391 |
| 960182E3 | FIAT | 391 |
| 960183 | FIAT | 10 |
| 960185 | FIAT | 10 |
| 960186E3 | FIAT | 392 |
| 960188 | FIAT | 10 |
| 960189 | FIAT | 10 |
| 960190 | FIAT | 392 |
| 960191 | RENAULT | 63 |
| 960192 | NISSAN | 50 |
| 960192 | OPEL | 55 |
| 960192 | RENAULT | 57 |
| 960193 | RENAULT | 64 |
| 960193 | VOLVO | 79 |
| 960197 | RENAULT | 62 |
| 960198 | RENAULT | 59 |
| 960199 | RENAULT | 60 |
| 960201 | FIAT | 9 |
| 960202 | FIAT | 9 |
| 960203 | NISSAN | 106 |
| 960204 | NISSAN | 106 |
| 960209 | RENAULT | 58 |
| 960213 | DAF | 8 |
| 960218 | RENAULT | 65 |
| 960218 | VOLVO | 81 |
| 960220 | NISSAN | 106 |
| 960222 | IVECO | 32 |
| 960222S | IVECO | 32 |
| 960224 | IVECO | 32 |

| Emmerre | Adaptable | Page |
|----------|-----------|------|
| 960224 | ROR | 70 |
| 960224S | IVECO | 32 |
| 960225 | RENAULT | 65 |
| 960226 | RENAULT | 65 |
| 960227 | RENAULT | 60 |
| 960228 | RENAULT | 61 |
| 960229 | RENAULT | 59 |
| 960230 | RENAULT | 59 |
| 960231 | NISSAN | 52 |
| 960231 | RENAULT | 57 |
| 960232 | IVECO | 27 |
| 960232S | IVECO | 27 |
| 960233 | NISSAN | 51 |
| 960233 | RENAULT | 56 |
| 960234 | OPEL | 55 |
| 960234 | RENAULT | 56 |
| 960235 | NISSAN | 52 |
| 960236 | NISSAN | 52 |
| 960237 | RENAULT | 61 |
| 960238 | RENAULT | 61 |
| 960239 | RENAULT | 62 |
| 960240 | RENAULT | 62 |
| 960240 | VOLVO | 79 |
| 960242 | RENAULT | 62 |
| 960243 | GASOLONE | 16 |
| 960244E3 | GASOLONE | 396 |
| 960252 | GASOLONE | 662 |
| 960256 | GASOLONE | 16 |
| 960257 | ROR | 614 |
| 960257 | VOLVO | 620 |
| 960258 | VOLVO | 619 |
| 960259 | VOLVO | 619 |
| 960260 | VOLVO | 619 |
| 960261 | VOLVO | 619 |
| 960262 | ROR | 615 |
| 960262 | VOLVO | 618 |
| 960263 | ROR | 615 |
| 960263 | VOLVO | 618 |
| 960264 | ROR | 616 |
| 960264 | VOLVO | 620 |
| 960265 | ROR | 615 |
| 960265 | VOLVO | 618 |
| 960266 | ROR | 614 |
| 960266 | VOLVO | 618 |
| 960267 | ROR | 614 |
| 960267 | VOLVO | 620 |
| 960269 | VARIOUS | 625 |
| 960270 | RENAULT | 440 |
| 960270 | VOLVO | 455 |
| 960271 | VOLVO | 453 |
| 960272E3 | DAF | 388 |
| 960272E3 | RENAULT | 441 |
| 960273 | VARIOUS | 625 |
| 960277 | ROR | 615 |
| 960277 | VARIOUS | 623 |
| 960279 | VARIOUS | 624 |
| 960280 | VARIOUS | 623 |
| 960281 | VARIOUS | 623 |
| 960282 | VARIOUS | 623 |
| 960283 | VARIOUS | 624 |
| 960288 | VARIOUS | 622 |
| 960289 | VARIOUS | 622 |
| 960290 | VARIOUS | 622 |
| 960291 | VARIOUS | 622 |
| 960294 | VARIOUS | 624 |

| Emmerre | Adaptable | Page |
|---------|----------------|------|
| 960295 | VARIOUS | 624 |
| 960296 | VARIOUS | 626 |
| 960297 | VARIOUS | 626 |
| 960298 | SAF | 71 |
| 960300 | ROR | 69 |
| 960301 | ROR | 68 |
| 960302 | VARIOUS | 625 |
| 960303 | DAF | 6 |
| 960304 | DAF | 6 |
| 960305 | RENAULT | 60 |
| 960306 | RENAULT | 63 |
| 960307 | RENAULT | 64 |
| 960308 | RENAULT | 61 |
| 960310 | VOLVO | 77 |
| 960311 | VOLVO | 77 |
| 960312 | VOLVO | 77 |
| 960313 | KASSBOHRER BUS | 17 |
| 960314 | KASSBOHRER BUS | 17 |
| 960315 | MERCEDES | 46 |
| 960316 | MERCEDES | 45 |
| 960317 | MERCEDES | 46 |
| 960318 | MERCEDES | 43 |
| 960319 | MERCEDES | 42 |
| 960320 | MAN | 35 |
| 960321 | MAN | 37 |
| 960322 | MAN | 37 |
| 960323 | MERCEDES | 40 |
| 960324 | MERCEDES | 40 |
| 960328 | MAN | 35 |
| 960329 | MAN | 36 |
| 960330 | IVECO | 689 |
| 960333 | MERCEDES | 39 |
| 960334 | MERCEDES | 39 |
| 960335 | MERCEDES | 42 |
| 960336 | MAN | 36 |
| 960336 | MERCEDES | 44 |
| 960337 | MERCEDES | 44 |
| 960338 | MERCEDES | 44 |
| 960339 | MERCEDES | 45 |
| 960340 | VARIOUS | 625 |
| 960341 | MERCEDES | 45 |
| 960342 | RENAULT | 60 |
| 960343 | MAN | 35 |
| 960344 | MAN | 36 |
| 960346 | MAN | 35 |
| 960346 | MERCEDES | 45 |
| 960347 | VOLVO | 453 |
| 960349 | VOLVO | 454 |
| 960350 | ROR | 67 |
| 960351 | ROR | 68 |
| 960352 | BPW | 1 |
| 960353 | SAF | 71 |
| 960354 | CARDI | 5 |
| 960356 | BPW | 3 |
| 960358 | BPW | 1 |
| 960359 | BPW | 2 |
| 960360 | BPW | 1 |
| 960361 | BPW | 1 |
| 960362 | SAF | 71 |
| 960363 | SMB | 76 |
| 960364 | SMB | 76 |
| 960368 | DAF | 6 |
| 960369 | DAF | 7 |
| 960370 | VOLVO | 82 |
| 960371 | SAF | 71 |

I riferimenti indicati non sono originali ma perfettamente intercambiabili. I codici originali e le case costruttrici sono indicati a puro titolo informativo
The details described are not original but perfectly interchangeable. The original references and manufacturer names are given for information purposes only.

RICERCA DI RIFERIMENTO EMMERRE SEARCH BY EMMERRE'S REFERENCE

| Emmerre | Adaptable | Page |
|----------|-----------|------|
| 960372 | IVECO | 557 |
| 960373 | IVECO | 557 |
| 960374 | VOLVO | 82 |
| 960375 | DAF | 7 |
| 960376 | DAF | 7 |
| 960377 | DAF | 7 |
| 960378 | FIAT | 9 |
| 960380 | FIAT | 9 |
| 960382 | FORD | 13 |
| 960383 | FORD | 13 |
| 960384 | FORD | 13 |
| 960385 | FORD | 13 |
| 960386 | FORD | 14 |
| 960387 | VOLVO | 78 |
| 960389 | DAF | 6 |
| 960390 | MERCEDES | 40 |
| 960391 | MERCEDES | 41 |
| 960392 | RENAULT | 59 |
| 960393 | MAN | 37 |
| 960394E3 | RENAULT | 443 |
| 960394E3 | ROR | 444 |
| 960394E3 | VOLVO | 453 |
| 960395 | SAF | 72 |
| 960396 | SAF | 72 |
| 960397 | LECINENA | 34 |
| 960399 | LECINENA | 34 |
| 960400 | ROR | 613 |
| 960400 | VOLVO | 621 |
| 960402 | IVECO | 27 |
| 960402S | IVECO | 27 |
| 960404 | IVECO | 30 |
| 960404S | IVECO | 30 |
| 960405 | IVECO | 30 |
| 960405S | IVECO | 30 |
| 960406 | IVECO | 31 |
| 960406S | IVECO | 31 |
| 960407 | VOLVO | 78 |
| 960408 | ISUZU | 398 |
| 960409 | IVECO | 26 |
| 960409S | IVECO | 26 |
| 960410 | ISUZU | 397 |
| 960411 | ISUZU | 397 |
| 960412 | ISUZU | 397 |
| 960416 | VARIOUS | 626 |
| 960417 | ROR | 69 |
| 960417 | VOLVO | 77 |
| 960419 | MAN | 36 |
| 960420 | VARIOUS | 626 |
| 960421 | MERCEDES | 39 |
| 960422 | MERCEDES | 41 |
| 960424 | VOLVO | 80 |
| 960427 | MERCEDES | 427 |
| 960428 | FIAT | 392 |
| 960430 | VOLVO | 452 |
| 960434 | RENAULT | 545 |
| 960434 | VOLVO | 551 |
| 960435 | MERCEDES | 538 |
| 960440 | RENAULT | 543 |
| 960441 | IVECO | 532 |
| 960444 | VOLVO | 80 |
| 960445 | ROR | 67 |
| 960446 | MERCEDES | 43 |
| 960447 | MERCEDES | 43 |
| 960449 | MERCEDES | 46 |
| 960450 | MERCEDES | 39 |

| Emmerre | Adaptable | Page |
|----------|-----------|------|
| 960451 | MERCEDES | 425 |
| 960452 | IVECO | 566 |
| 960453 | IVECO | 566 |
| 960456 | VOLVO | 82 |
| 960457 | VOLVO | 82 |
| 960458 | NISSAN | 50 |
| 960458 | RENAULT | 57 |
| 960459 | NISSAN | 433 |
| 960459 | RENAULT | 437 |
| 960460 | NISSAN | 50 |
| 960460 | RENAULT | 58 |
| 960461 | NISSAN | 433 |
| 960461 | RENAULT | 437 |
| 960462 | NISSAN | 49 |
| 960462 | RENAULT | 58 |
| 960463 | VOLVO | 81 |
| 960464 | RENAULT | 65 |
| 960464 | ROR | 69 |
| 960465 | FORD | 14 |
| 960466 | FORD | 14 |
| 960467 | SAF | 73 |
| 960468 | SAF | 72 |
| 960469 | SAF | 72 |
| 960472 | NISSAN | 53 |
| 960472 | OPEL | 55 |
| 960472 | RENAULT | 56 |
| 960473 | NISSAN | 54 |
| 960473 | OPEL | 55 |
| 960473 | RENAULT | 56 |
| 960474 | ROR | 67 |
| 960474 | VOLVO | 78 |
| 960475 | RENAULT | 63 |
| 960475 | VOLVO | 80 |
| 960476 | FORD | 14 |
| 960477 | FORD | 15 |
| 960478 | DAF | 8 |
| 960479 | MAN | 38 |
| 960480 | MAN | 38 |
| 960481 | RENAULT | 64 |
| 960481 | VOLVO | 79 |
| 960482 | RENAULT | 63 |
| 960482 | VOLVO | 79 |
| 960483 | NISSAN | 49 |
| 960483 | RENAULT | 66 |
| 960484 | SAF | 73 |
| 960486 | VOLVO | 81 |
| 960490 | IVECO | 32 |
| 960490 | ROR | 69 |
| 960492 | BPW | 519 |
| 960493 | BPW | 519 |
| 960494 | IVECO | 28 |
| 960494S | IVECO | 28 |
| 960495 | IVECO | 28 |
| 960495S | IVECO | 28 |
| 960498 | IVECO | 23 |
| 960498S | IVECO | 23 |
| 960500 | IVECO | 32 |
| 960500 | RENAULT | 64 |
| 960500S | IVECO | 32 |
| 960501 | IVECO | 22 |
| 960501S | IVECO | 22 |
| 960502E3 | IVECO | 403 |
| 960503E3 | IVECO | 404 |
| 960504E3 | IVECO | 404 |
| 960506 | IVECO | 28 |

| Emmerre | Adaptable | Page |
|-----------|------------|------|
| 960506S | IVECO | 28 |
| 960507 | IVECO | 28 |
| 960507S | IVECO | 28 |
| 960508 | IVECO | 533 |
| 960511 | DAF | 658 |
| 960511 | IVECO | 676 |
| 960511 | ROR | 712 |
| 960512 | IVECO | 23 |
| 960512S | IVECO | 23 |
| 960513E3 | IVECO | 405 |
| 960513E11 | IVECO | 405 |
| 960514 | IVECO | 527 |
| 960515 | IVECO | 23 |
| 960515S | IVECO | 23 |
| 960516E3 | IVECO | 405 |
| 960516E11 | IVECO | 405 |
| 960517 | IVECO | 527 |
| 960518 | ISUZU | 18 |
| 960519 | ISUZU | 18 |
| 960520 | ISUZU | 18 |
| 960521 | ISUZU | 18 |
| 960522 | NISSAN | 51 |
| 960522 | RENAULT | 58 |
| 960523 | BPW | 519 |
| 960523 | CARDI | 520 |
| 960523 | DAF | 521 |
| 960523 | SAF | 547 |
| 960523 | SCANIA | 549 |
| 960523 | SMB | 550 |
| 960523 | VOLVO | 551 |
| 960524 | SAF | 547 |
| 960525 | ROR | 546 |
| 960525 | VOLVO | 551 |
| 960526 | NISSAN | 52 |
| 960527 | NISSAN | 53 |
| 960529 | BPW | 519 |
| 960530 | ROR | 546 |
| 960531 | ROR | 546 |
| 960532 | ROR | 546 |
| 960539 | mitsubishi | 47 |
| 960540 | mitsubishi | 47 |
| 960541 | mitsubishi | 47 |
| 960543 | mitsubishi | 47 |
| 960545 | ISUZU | 19 |
| 960546 | mitsubishi | 48 |
| 960551 | DAF | 521 |
| 960553 | MAN | 535 |
| 960561 | IVECO | 646 |
| 960564 | MERCEDES | 41 |
| 960565 | MERCEDES | 41 |
| 960566 | ROR | 651 |
| 960567 | ROR | 651 |
| 960568 | ROR | 651 |
| 960569 | ROR | 651 |
| 960570 | BPW | 2 |
| 960571 | BPW | 3 |
| 960572 | BPW | 3 |
| 960573 | BPW | 4 |
| 960574 | BPW | 2 |
| 960575 | BPW | 2 |
| 960576 | BPW | 3 |
| 960578 | ROR | 70 |
| 960579 | ROR | 70 |
| 960581 | ROR | 70 |
| 960582 | SAF | 548 |

I riferimenti indicati non sono originali ma perfettamente intercambiabili. I codici originali e le case costruttrici sono indicati a puro titolo informativo
The details described are not original but perfectly interchangeable. The original references and manufacturer names are given for information purposes only.

| Emmerre | Adaptable | Page |
|---------|-----------|------|
| 960583 | IVECO | 33 |
| 960584 | SAF | 547 |
| 960585 | SAF | 547 |
| 960586 | ROR | 652 |
| 960587 | ROR | 652 |
| 960590 | IVECO | 689 |
| 960591 | RENAULT | 705 |
| 960600 | CARDI | 5 |
| 960601 | IVECO | 676 |
| 960601 | ROR | 713 |
| 960603 | IVECO | 676 |
| 960603 | ROR | 712 |
| 960608 | VOLVO | 83 |
| 960609 | VOLVO | 83 |
| 960676 | IVECO | 533 |
| 960678 | NISSAN | 609 |
| 960678 | OPEL | 610 |
| 960678 | RENAULT | 611 |
| 960679 | NISSAN | 609 |
| 960679 | OPEL | 610 |
| 960679 | RENAULT | 611 |
| 960680 | NISSAN | 609 |
| 960680 | OPEL | 610 |
| 960680 | RENAULT | 612 |
| 960682 | IVECO | 526 |
| 960683 | ROR | 67 |
| 960683 | VOLVO | 78 |
| 960684 | IVECO | 525 |
| 960685 | IVECO | 527 |
| 960686 | MERCEDES | 40 |
| 960687 | IVECO | 526 |
| 960688 | IVECO | 531 |
| 960689 | IVECO | 529 |
| 960693 | IVECO | 33 |
| 960693 | MERCEDES | 46 |
| 960693 | SCANIA | 74 |
| 960694 | IVECO | 24 |
| 960694S | IVECO | 24 |
| 960695 | IVECO | 24 |
| 960695S | IVECO | 24 |
| 960696 | IVECO | 23 |
| 960696S | IVECO | 23 |
| 960697 | IVECO | 24 |
| 960697S | IVECO | 24 |
| 960698 | IVECO | 24 |
| 960698S | IVECO | 24 |
| 960700 | IVECO | 587 |
| 960703 | IVECO | 587 |
| 960705 | IVECO | 598 |
| 960706 | IVECO | 600 |
| 960708 | IVECO | 604 |
| 960708 | MAN | 607 |
| 960708 | MERCEDES | 608 |
| 960709 | BPW | 582 |
| 960709 | DAF | 583 |
| 960709 | IVECO | 604 |
| 960709 | MAN | 607 |
| 960709 | MERCEDES | 608 |
| 960710 | DAF | 583 |
| 960710 | IVECO | 604 |
| 960710 | MAN | 607 |
| 960711 | IVECO | 599 |
| 960712 | IVECO | 599 |
| 960713 | IVECO | 586 |
| 960714 | IVECO | 593 |

| Emmerre | Adaptable | Page |
|---------|-----------|------|
| 960714 | NISSAN | 609 |
| 960715 | IVECO | 594 |
| 960715 | RENAULT | 611 |
| 960716 | IVECO | 594 |
| 960717 | IVECO | 594 |
| 960718 | IVECO | 594 |
| 960719 | IVECO | 590 |
| 960720 | IVECO | 590 |
| 960721 | IVECO | 591 |
| 960722 | IVECO | 600 |
| 960723 | IVECO | 600 |
| 960724 | IVECO | 606 |
| 960725 | IVECO | 596 |
| 960726 | IVECO | 595 |
| 960727 | IVECO | 595 |
| 960728 | IVECO | 602 |
| 960728 | ROR | 613 |
| 960729 | IVECO | 602 |
| 960730 | IVECO | 602 |
| 960730 | ROR | 613 |
| 960731 | DAF | 583 |
| 960731 | IVECO | 604 |
| 960731 | MAN | 607 |
| 960731 | MERCEDES | 608 |
| 960731 | SCANIA | 617 |
| 960734 | DAF | 583 |
| 960734 | IVECO | 603 |
| 960735 | IVECO | 603 |
| 960738 | IVECO | 602 |
| 960739 | IVECO | 593 |
| 960740 | IVECO | 591 |
| 960741 | IVECO | 603 |
| 960742 | IVECO | 587 |
| 960743 | IVECO | 591 |
| 960744 | IVECO | 590 |
| 960745 | IVECO | 584 |
| 960746 | IVECO | 590 |
| 960748 | IVECO | 589 |
| 960749 | IVECO | 589 |
| 960751 | FORD | 524 |
| 960752 | RENAULT | 611 |
| 960752 | VOLVO | 621 |
| 960753 | MAN | 537 |
| 960754 | IVECO | 592 |
| 960755 | FORD | 524 |
| 960756 | IVECO | 592 |
| 960757 | MAN | 536 |
| 960757 | MERCEDES | 540 |
| 960758 | IVECO | 592 |
| 960759 | IVECO | 592 |
| 960764 | FORD | 396 |
| 960765 | FORD | 396 |
| 960766 | FORD | 524 |
| 960767 | RENAULT | 544 |
| 960768 | RENAULT | 544 |
| 960768 | VOLVO | 552 |
| 960769 | RENAULT | 544 |
| 960769 | VOLVO | 552 |
| 960770 | IVECO | 525 |
| 960771 | FORD | 524 |
| 960774 | DAF | 521 |
| 960775 | MERCEDES | 427 |
| 960776 | MERCEDES | 426 |
| 960777 | MERCEDES | 424 |
| 960778 | IVECO | 528 |

| Emmerre | Adaptable | Page |
|----------|-----------|------|
| 960779 | IVECO | 528 |
| 960780 | IVECO | 527 |
| 960781 | VOLVO | 552 |
| 960783 | VOLVO | 552 |
| 960784 | FORD | 395 |
| 960786 | NISSAN | 434 |
| 960786 | RENAULT | 438 |
| 960787 | NISSAN | 434 |
| 960787 | RENAULT | 437 |
| 960788 | ROR | 445 |
| 960789 | RENAULT | 436 |
| 960790 | RENAULT | 436 |
| 960791 | RENAULT | 436 |
| 960792 | MERCEDES | 425 |
| 960793 | MAN | 423 |
| 960794E3 | DAF | 389 |
| 960794E3 | IVECO | 414 |
| 960794E3 | MAN | 422 |
| 960794E3 | MERCEDES | 429 |
| 960794E3 | SAF | 448 |
| 960796E3 | MERCEDES | 430 |
| 960797E3 | MERCEDES | 430 |
| 960798E3 | IVECO BUS | 416 |
| 960801 | DAF | 521 |
| 960803 | MAN | 535 |
| 960804 | RENAULT | 545 |
| 960805 | IVECO | 530 |
| 960806 | RENAULT | 543 |
| 960807 | IVECO | 533 |
| 960807 | MAN | 536 |
| 960808 | MERCEDES | 539 |
| 960810 | MAN | 536 |
| 960810 | MERCEDES | 539 |
| 960811 | MAN | 535 |
| 960814 | RENAULT | 543 |
| 960819 | NISSAN | 541 |
| 960819 | RENAULT | 542 |
| 960822 | IVECO | 534 |
| 960822 | MAN | 536 |
| 960823 | RENAULT | 440 |
| 960823 | VOLVO | 455 |
| 960824 | MERCEDES | 538 |
| 960825 | MERCEDES | 538 |
| 960828 | IVECO | 587 |
| 960829 | IVECO | 586 |
| 960830 | IVECO | 586 |
| 960832 | IVECO | 584 |
| 960833 | IVECO | 595 |
| 960834 | IVECO | 586 |
| 960835 | IVECO | 593 |
| 960836 | IVECO | 593 |
| 960837 | IVECO | 598 |
| 960838 | SCANIA | 549 |
| 960839 | IVECO | 530 |
| 960840 | IVECO | 689 |
| 960841 | IVECO | 599 |
| 960842 | MERCEDES | 539 |
| 960843 | IVECO | 598 |
| 960844 | IVECO | 687 |
| 960845 | IVECO | 687 |
| 960846 | IVECO | 585 |
| 960847 | IVECO | 598 |
| 960848 | IVECO | 585 |
| 960849 | IVECO | 599 |
| 960850 | IVECO | 585 |

RICERCA DI RIFERIMENTO EMMERRE SEARCH BY EMMERRE'S REFERENCE

| Emmerre | Adaptable | Page |
|-----------|-----------|------|
| 960852 | IVECO | 530 |
| 960855 | IVECO | 688 |
| 960856 | IVECO | 688 |
| 960857 | IVECO | 689 |
| 960859 | IVECO | 688 |
| 960860 | IVECO | 688 |
| 960862 | FIAT | 390 |
| 960863 | IVECO | 526 |
| 960864 | IVECO | 525 |
| 960867 | FIAT | 390 |
| 960868 | FORD | 394 |
| 960869 | FORD | 394 |
| 960870E3 | FORD | 394 |
| 960871E3 | FORD | 395 |
| 960872E3 | NISSAN | 432 |
| 960873 | NISSAN | 649 |
| 960873 | RENAULT | 650 |
| 960874E3 | NISSAN | 432 |
| 960875E3 | NISSAN | 432 |
| 960877 | IVECO | 528 |
| 960878 | IVECO | 529 |
| 960879 | IVECO | 525 |
| 960880 | IVECO | 529 |
| 960881 | IVECO | 530 |
| 960882 | IVECO | 532 |
| 960883 | IVECO | 664 |
| 960884 | IVECO | 664 |
| 960885 | IVECO | 532 |
| 960886 | IVECO | 531 |
| 960887 | IVECO | 531 |
| 960888 | IVECO | 529 |
| 960889 | IVECO | 585 |
| 960890 | MERCEDES | 426 |
| 960891 | MERCEDES | 430 |
| 960891 | SAF | 447 |
| 960891 | SCHMITZ | 450 |
| 960892 | IVECO | 400 |
| 960893E3 | IVECO | 400 |
| 960894E3 | IVECO | 399 |
| 960895E3 | IVECO | 406 |
| 960895E11 | IVECO | 406 |
| 960896 | MERCEDES | 427 |
| 960897 | IVECO | 412 |
| 960898 | IVECO | 400 |
| 960899E3 | IVECO | 405 |
| 960900E3 | IVECO | 401 |
| 960901E3 | IVECO BUS | 415 |
| 960902E3 | IVECO | 411 |
| 960903 | IVECO | 410 |
| 960904 | DAF | 387 |
| 960904 | IVECO | 409 |
| 960905 | IVECO | 532 |
| 960907 | IVECO | 533 |
| 960908 | IVECO | 531 |
| 960909E3 | IVECO | 403 |
| 960910E3 | IVECO | 402 |
| 960911E3 | FORD | 395 |
| 960911E3 | IVECO | 402 |
| 960912E3 | IVECO | 410 |
| 960913E3 | IVECO | 399 |
| 960914 | MERCEDES | 540 |
| 960915 | MERCEDES | 538 |
| 960916 | MERCEDES | 539 |
| 960917 | RENAULT | 543 |
| 960918 | RENAULT | 542 |

| Emmerre | Adaptable | Page |
|----------|----------------|------|
| 960919 | RENAULT | 542 |
| 960920E3 | MERCEDES | 425 |
| 960921 | MERCEDES | 424 |
| 960922 | MERCEDES | 426 |
| 960923 | IVECO | 21 |
| 960923S | IVECO | 21 |
| 960924 | IVECO | 21 |
| 960924S | IVECO | 21 |
| 960925 | IVECO | 21 |
| 960925S | IVECO | 21 |
| 960926 | MERCEDES | 424 |
| 960927E3 | VOLVO | 452 |
| 960928E3 | ROR | 444 |
| 960929 | FIAT | 390 |
| 960930 | IVECO | 588 |
| 960932 | IVECO | 528 |
| 960933 | RENAULT | 545 |
| 960935 | FIAT | 391 |
| 960937E3 | IVECO | 413 |
| 960938E3 | IVECO | 411 |
| 960939E3 | IVECO | 410 |
| 960939E3 | RENAULT | 439 |
| 960940 | IVECO | 402 |
| 960941E3 | IVECO | 401 |
| 960943 | DAF | 387 |
| 960944E1 | BPW | 384 |
| 960944E1 | CARDI | 386 |
| 960944E1 | DAF | 388 |
| 960944E1 | IVECO | 414 |
| 960944E1 | IVECO BUS | 416 |
| 960944E1 | LECINENA | 419 |
| 960944E1 | MAN | 422 |
| 960944E1 | MERCEDES | 429 |
| 960944E1 | SAF | 446 |
| 960944E1 | SCANIA | 449 |
| 960944E1 | SCHMITZ | 450 |
| 960944E1 | SMB | 451 |
| 960944E3 | BPW | 384 |
| 960944E3 | CARDI | 386 |
| 960944E3 | DAF | 388 |
| 960944E3 | IVECO | 414 |
| 960944E3 | IVECO BUS | 416 |
| 960944E3 | LECINENA | 419 |
| 960944E3 | MAN | 422 |
| 960944E3 | MERCEDES | 429 |
| 960944E3 | SAF | 446 |
| 960944E3 | SCANIA | 449 |
| 960944E3 | SCHMITZ | 450 |
| 960944E3 | SMB | 451 |
| 960946E3 | MERCEDES | 428 |
| 960947E3 | NISSAN | 434 |
| 960948E3 | BPW | 383 |
| 960948E3 | CARDI | 386 |
| 960948E3 | MAN | 420 |
| 960948E3 | MERCEDES | 429 |
| 960948E3 | SAF | 446 |
| 960948E3 | SMB | 451 |
| 960949E3 | SAF | 447 |
| 960949E3 | SMB | 451 |
| 960950E3 | IVECO BUS | 416 |
| 960950E3 | KASSBOHRER BUS | 417 |
| 960951 | IVECO | 675 |
| 960951 | ROR | 712 |
| 960952E3 | IVECO BUS | 415 |
| 960955E3 | MAN | 420 |

| Emmerre | Adaptable | Page |
|-----------|----------------|---------|
| 960956E1 | KASSBOHRER BUS | 418 |
| 960956E1 | MAN | 421 |
| 960956E1 | MERCEDES | 431 |
| 960956E1 | RENAULT | 442 |
| 960956E1 | ROR | 445 |
| 960956E3 | KASSBOHRER BUS | 418 |
| 960956E3 | MAN | 421 |
| 960956E3 | MERCEDES | 431 |
| 960956E3 | RENAULT | 442 |
| 960956E3 | ROR | 445 |
| 960958 | RENAULT | 441 |
| 960959E3 | RENAULT | 439 |
| 960960E3 | KASSBOHRER BUS | 417 |
| 960961E3 | KASSBOHRER BUS | 417 |
| 960963E3 | VOLVO | 452 |
| 960964E3 | VOLVO BUS | 456 |
| 960965 | IVECO | 676 |
| 960965 | ROR | 712 |
| 960967E3 | MERCEDES | 428 |
| 960969E3 | DAF | 387 |
| 960969E3 | IVECO | 412 |
| 960969E3 | MAN | 420 |
| 960969E3 | RENAULT | 440 |
| 960970E3 | IVECO | 412 |
| 960972E3 | RENAULT | 438 |
| 960973E3 | IVECO | 404 |
| 960974 | IVECO | 401 |
| 960975 | KASSBOHRER BUS | 523 |
| 960975 | MERCEDES | 540 |
| 960975 | SCANIA | 549 |
| 960976 | KASSBOHRER BUS | 523 |
| 960976 | MAN | 535 |
| 960977 | RENAULT | 542-545 |
| 960977 | VOLVO | 551 |
| 960979 | IVECO | 526 |
| 960982E3 | RENAULT | 442 |
| 960983E3 | RENAULT | 442 |
| 960984E3 | MAN | 421 |
| 960985E3 | RENAULT | 435 |
| 960986 | RENAULT | 435 |
| 960987E3 | RENAULT | 438 |
| 960988E3 | RENAULT | 435 |
| 960989E1 | RENAULT | 443 |
| 960989E3 | RENAULT | 443 |
| 960991 | NISSAN | 433 |
| 960991 | RENAULT | 439 |
| 960992E3 | IVECO | 403 |
| 960993E3 | ROR | 445 |
| 960993E3 | VOLVO | 454 |
| 960994E3 | BPW | 383 |
| 960995 | IVECO | 399 |
| 960996E1 | BPW | 384 |
| 960996E3 | BPW | 384 |
| 960996E11 | BPW | 384 |
| 960997E3 | BPW | 384 |
| 960998E3 | BPW | 383 |
| 960998E3 | MAN | 421 |
| 960998E3 | MERCEDES | 428 |
| 960998E11 | BPW | 383 |
| 960998E11 | MAN | 421 |
| 960998E11 | MERCEDES | 428 |
| 960999E3 | DAF | 388 |
| 960999E3 | SAF | 446 |
| 961000 | FIAT | 635 |
| 961002 | ROR | 724 |

I riferimenti indicati non sono originali ma perfettamente intercambiabili. I codici originali e le case costruttrici sono indicati a puro titolo informativo
The details described are not original but perfectly interchangeable. The original references and manufacturer names are given for information purposes only.

| Emmerre | Adaptable | Page |
|----------|-----------|------|
| 961002 | VOLVO | 735 |
| 961003 | ROR | 724 |
| 961003 | VOLVO | 735 |
| 961008 | IVECO | 640 |
| 961009 | IVECO | 637 |
| 961010 | IVECO | 638 |
| 961011 | IVECO | 637 |
| 961012 | FIAT | 635 |
| 961013 | IVECO | 641 |
| 961015 | IVECO | 406 |
| 961018 | IVECO | 637 |
| 961033 | IVECO | 413 |
| 961034 | IVECO | 413 |
| 961037 | IVECO | 638 |
| 961040 | IVECO | 638 |
| 961041 | DAF | 389 |
| 961041 | IVECO | 414 |
| 961041 | MAN | 422 |
| 961041 | RENAULT | 443 |
| 961042 | IVECO | 637 |
| 961043 | IVECO | 669 |
| 961043 | ROR | 711 |
| 961044 | FIAT | 662 |
| 961045 | IVECO | 666 |
| 961046 | IVECO | 666 |
| 961047 | IVECO | 666 |
| 961049 | RENAULT | 441 |
| 961050 | FIAT | 635 |
| 961055 | IVECO | 641 |
| 961056 | IVECO | 639 |
| 961057 | FIAT | 635 |
| 961062 | FORD | 636 |
| 961062 | NISSAN | 649 |
| 961063 | VOLVO | 621 |
| 961070E3 | SAF | 448 |
| 961071E3 | SCHMITZ | 450 |
| 961075 | IVECO | 408 |
| 961076 | IVECO | 408 |
| 961077 | IVECO | 409 |
| 961078 | IVECO | 409 |
| 961079 | IVECO | 406 |
| 961080 | IVECO | 407 |
| 961081 | IVECO | 407 |
| 961082 | IVECO | 407 |
| 961083 | IVECO | 408 |
| 961089 | IVECO | 534 |
| 961310 | RENAULT | 351 |
| 961310 | VOLVO | 358 |
| 961311 | RENAULT | 350 |
| 961311 | VOLVO | 359 |
| 961312 | RENAULT | 350 |
| 961312 | VOLVO | 357 |
| 961313 | RENAULT | 351 |
| 961313 | VOLVO | 357 |
| 961318 | DAF | 337 |
| 961318 | SAF | 353 |
| 961322 | SCANIA | 354 |
| 961323 | SCANIA | 354 |
| 961328 | VOLVO | 358 |
| 961329 | VOLVO | 358 |
| 961330 | VOLVO | 357 |
| 961362 | IVECO | 339 |
| 961363 | IVECO | 339 |
| 961366 | DAF | 338 |
| 961366 | IVECO | 342 |

| Emmerre | Adaptable | Page |
|---------|-----------|------|
| 961366 | MAN | 344 |
| 961366 | MERCEDES | 347 |
| 961366 | RENAULT | 350 |
| 961367 | DAF | 338 |
| 961367 | IVECO | 341 |
| 961367 | RENAULT | 350 |
| 961367 | SCANIA | 354 |
| 961367 | VOLVO | 358 |
| 961368 | DAF | 337 |
| 961369 | IVECO | 339 |
| 961370 | DAF | 337 |
| 961370 | IVECO | 342 |
| 961370 | MAN | 343 |
| 961370 | RENAULT | 352 |
| 961370 | SAF | 353 |
| 961370 | SCANIA | 355 |
| 961371 | BPW | 335 |
| 961371 | DAF | 336 |
| 961371 | IVECO | 341 |
| 961371 | MERCEDES | 347 |
| 961371 | RENAULT | 351 |
| 961371 | SAF | 353 |
| 961371 | SCANIA | 355 |
| 961371 | SCHMITZ | 356 |
| 961372 | BPW | 335 |
| 961372 | DAF | 337 |
| 961372 | MAN | 343 |
| 961372 | RENAULT | 351 |
| 961372 | SCANIA | 354 |
| 961373 | DAF | 336 |
| 961373 | MAN | 345 |
| 961374 | IVECO | 340 |
| 961375 | DAF | 336 |
| 961375 | IVECO | 340 |
| 961376 | IVECO | 340 |
| 961377 | IVECO | 341 |
| 961378 | IVECO | 341 |
| 961379 | DAF | 336 |
| 961379 | IVECO | 340 |
| 961380 | IVECO | 339 |
| 961381 | MAN | 343 |
| 961382 | MAN | 343 |
| 961383 | MAN | 344 |
| 961384 | MAN | 345 |
| 961386 | MAN | 346 |
| 961387 | MAN | 344 |
| 961388 | RENAULT | 352 |
| 961388 | VOLVO | 357 |
| 961389 | MAN | 346 |
| 961390 | MAN | 345 |
| 961391 | MAN | 345 |
| 961392 | MERCEDES | 347 |
| 961393 | MAN | 344 |
| 961393 | MERCEDES | 347 |
| 961395 | MERCEDES | 348 |
| 961396 | MERCEDES | 348 |
| 961397 | MERCEDES | 348 |
| 961398 | MERCEDES | 348 |
| 961399 | MERCEDES | 349 |
| 961523 | IVECO | 665 |
| 962000 | IVECO | 367 |
| 962002 | IVECO | 367 |
| 962098 | RENAULT | 702 |
| 962099 | RENAULT | 702 |
| 962100 | RENAULT | 702 |

| Emmerre | Adaptable | Page |
|---------|-----------|------|
| 962288 | IVECO | 639 |
| 962501 | IVECO | 690 |
| 962504 | IVECO | 690 |
| 962504 | MAN | 695 |
| 962504 | ROR | 722 |
| 962504 | VOLVO | 729 |
| 962505 | IVECO | 690 |
| 963001 | IVECO | 671 |
| 963001 | ROR | 709 |
| 963002 | DAF | 658 |
| 963002 | IVECO | 670 |
| 963002 | ROR | 708 |
| 963003 | IVECO | 670 |
| 963003 | ROR | 708 |
| 963004 | DAF | 659 |
| 963004 | IVECO | 686 |
| 963005 | IVECO | 671 |
| 963005 | ROR | 671 |
| 963006 | IVECO | 671 |
| 963006 | ROR | 709 |
| 963007 | IVECO | 671 |
| 963007 | ROR | 709 |
| 963009 | IVECO | 680 |
| 963010 | IVECO | 674 |
| 963010 | VOLVO | 728 |
| 963011 | IVECO | 674 |
| 963011 | VOLVO | 728 |
| 963012 | IVECO | 674 |
| 963012 | ROR | 711 |
| 963012 | VOLVO | 728 |
| 963013 | IVECO | 673 |
| 963013 | ROR | 711 |
| 963014 | IVECO | 675 |
| 963014 | ROR | 713 |
| 963015 | IVECO | 675 |
| 963015 | ROR | 714 |
| 963016 | IVECO | 675 |
| 963016 | ROR | 714 |
| 963017 | IVECO | 674 |
| 963017 | ROR | 713 |
| 963019 | DAF | 657 |
| 963019 | IVECO | 667 |
| 963019 | RENAULT | 702 |
| 963020 | IVECO | 673 |
| 963020 | ROR | 711 |
| 963020 | VOLVO | 728 |
| 963021 | DAF | 658 |
| 963021 | IVECO | 670 |
| 963021 | ROR | 708 |
| 963022 | IVECO | 672 |
| 963022 | ROR | 710 |
| 963023 | IVECO | 672 |
| 963023 | ROR | 710 |
| 963024 | IVECO | 672 |
| 963024 | ROR | 709 |
| 963025 | IVECO | 673 |
| 963025 | ROR | 710 |
| 963026 | IVECO | 673 |
| 963026 | ROR | 710 |
| 963027 | IVECO | 680 |
| 963027 | ROR | 713 |
| 963028 | IVECO | 690 |
| 963067 | IVECO | 691 |
| 963068 | IVECO | 629 |
| 963068 | ROR | 633 |

RICERCA DI RIFERIMENTO EMMERRE SEARCH BY EMMERRE'S REFERENCE

| Emmerre | Adaptable | Page |
|---------|-----------|------|
| 963069 | IVECO | 629 |
| 963069 | ROR | 633 |
| 963084 | IVECO | 663 |
| 963085 | IVECO | 663 |
| 963086 | IVECO | 627 |
| 963087 | IVECO | 627 |
| 963088 | IVECO | 665 |
| 963089 | IVECO | 665 |
| 963097 | IVECO | 627 |
| 963098 | IVECO | 627 |
| 963100 | IVECO | 663 |
| 963101 | IVECO | 663 |
| 963106 | IVECO | 670 |
| 963106 | ROR | 714 |
| 963110 | IVECO | 632 |
| 963111 | IVECO | 632 |
| 963114 | IVECO | 628 |
| 963115 | IVECO | 628 |
| 963116 | IVECO | 664 |
| 963117 | IVECO | 664 |
| 963121 | IVECO | 645 |
| 963122 | IVECO | 645 |
| 963123 | IVECO | 646 |
| 963125 | IVECO | 678 |
| 963127 | IVECO | 686 |
| 963128 | IVECO | 644 |
| 963129 | IVECO | 645 |
| 963131 | IVECO | 683 |
| 963131 | ROR | 717 |
| 963456 | IVECO | 630 |
| 963456 | ROR | 633 |
| 963457 | IVECO | 630 |
| 963457 | ROR | 633 |
| 963465 | IVECO | 683 |
| 963465 | ROR | 719 |
| 963466 | IVECO | 684 |
| 963466 | ROR | 719 |
| 963467 | IVECO | 685 |
| 963467 | ROR | 719 |
| 963468 | IVECO | 686 |
| 963468 | ROR | 719 |
| 963498 | IVECO | 643 |
| 963499 | IVECO | 644 |
| 963518 | IVECO | 685 |
| 963519 | IVECO | 640 |
| 963520 | IVECO | 642 |
| 963521 | IVECO | 642 |
| 963522 | IVECO | 642 |
| 963525 | IVECO | 666 |
| 963526 | IVECO | 640 |
| 963528 | IVECO | 643 |
| 963529 | IVECO | 641 |
| 963531 | IVECO | 642 |
| 963532 | IVECO | 681 |
| 963532 | MAN | 694 |
| 963533 | IVECO | 678 |
| 963533 | ROR | 714 |
| 963534 | IVECO | 680 |
| 963534 | ROR | 715 |
| 963535 | IVECO | 677 |
| 963535 | ROR | 715 |
| 963536 | IVECO | 679 |
| 963536 | ROR | 715 |
| 963537 | IVECO | 679 |
| 963537 | MAN | 694 |

| Emmerre | Adaptable | Page |
|---------|-----------|------|
| 963537 | ROR | 716 |
| 963538 | IVECO | 679 |
| 963538 | MAN | 694 |
| 963538 | ROR | 716 |
| 963539 | IVECO | 679 |
| 963539 | ROR | 716 |
| 963540 | IVECO | 680 |
| 963540 | ROR | 721 |
| 963541 | IVECO | 677 |
| 963541 | MAN | 694 |
| 963541 | NISSAN | 701 |
| 963541 | ROR | 715 |
| 963541 | VOLVO | 729 |
| 963543 | IVECO | 645 |
| 963545 | IVECO | 640 |
| 963547 | IVECO | 672 |
| 963548 | IVECO | 678 |
| 963548 | ROR | 717 |
| 963551 | IVECO | 630 |
| 963552 | IVECO | 630 |
| 963553 | DAF | 658 |
| 963553 | IVECO | 677 |
| 963553 | ROR | 716 |
| 963554 | DAF | 657 |
| 963554 | IVECO | 668 |
| 963555 | IVECO | 678 |
| 963555 | ROR | 717 |
| 963556 | IVECO | 669 |
| 963556 | ROR | 717 |
| 963557 | IVECO | 631 |
| 963558 | IVECO | 631 |
| 963559 | IVECO | 643 |
| 963560 | IVECO | 681 |
| 963560 | ROR | 721 |
| 963569 | IVECO | 682 |
| 963569 | ROR | 718 |
| 963570 | IVECO | 632 |
| 963571 | IVECO | 632 |
| 963574 | IVECO | 682 |
| 963574 | MERCEDES | 698 |
| 963574 | ROR | 718 |
| 963575 | IVECO | 682 |
| 963575 | ROR | 720 |
| 963576 | IVECO | 683 |
| 963576 | ROR | 721 |
| 963583 | IVECO | 685 |
| 963584 | RENAULT | 706 |
| 963584 | ROR | 722 |
| 963584 | VOLVO | 733 |
| 963585 | RENAULT | 707 |
| 963585 | ROR | 723 |
| 963585 | VOLVO | 733 |
| 963586 | RENAULT | 707 |
| 963586 | ROR | 723 |
| 963586 | VOLVO | 733 |
| 963587 | RENAULT | 707 |
| 963587 | ROR | 723 |
| 963587 | VOLVO | 734 |
| 963588 | ROR | 723 |
| 963588 | VOLVO | 734 |
| 963589 | ROR | 724 |
| 963589 | VOLVO | 734 |
| 963590 | IVECO | 644 |
| 963591 | IVECO | 644 |
| 963593 | IVECO | 683 |

| Emmerre | Adaptable | Page |
|---------|-----------|------|
| 963594 | IVECO | 681 |
| 963594 | ROR | 718 |
| 963595 | IVECO | 682 |
| 963595 | ROR | 718 |
| 963596 | IVECO | 681 |
| 963597 | IVECO | 665 |
| 963598 | IVECO | 667 |
| 963599 | IVECO | 668 |
| 963602 | ROR | 722 |
| 963602 | VOLVO | 731 |
| 963604 | RENAULT | 705 |
| 963604 | VOLVO | 731 |
| 963606 | RENAULT | 705 |
| 963606 | ROR | 722 |
| 963606 | VOLVO | 732 |
| 963607 | RENAULT | 706 |
| 963607 | VOLVO | 732 |
| 963608 | VOLVO | 732 |
| 963610 | RENAULT | 706 |
| 963610 | VOLVO | 732 |
| 963611 | RENAULT | 706 |
| 963611 | VOLVO | 733 |
| 963612 | RENAULT | 707 |
| 963612 | ROR | 724 |
| 963612 | VOLVO | 734 |
| 963614 | IVECO | 641 |
| 963615 | IVECO | 643 |
| 963618 | IVECO | 667 |
| 963619 | IVECO | 668 |
| 963620 | IVECO | 668 |
| 963622 | DAF | 657 |
| 963622 | IVECO | 667 |
| 963623 | IVECO | 646 |
| 963624 | IVECO | 685 |
| 963625 | IVECO | 684 |
| 963625 | ROR | 720 |
| 963626 | IVECO | 684 |
| 963626 | ROR | 720 |
| 963627 | IVECO | 684 |
| 963627 | ROR | 720 |
| 963630 | IVECO | 686 |
| 963632 | VOLVO | 735 |
| 963633 | VOLVO | 735 |
| 963650 | BPW | 634 |
| 963651 | BPW | 634 |
| 963700 | SAF | 653 |
| 963750 | MAN | 647 |
| 963750 | MERCEDES | 648 |
| 963751 | MAN | 647 |
| 963754 | MERCEDES | 648 |
| 963800 | SCANIA | 654 |
| 963802 | SCANIA | 654 |
| 963850 | VOLVO | 655 |
| 963851 | VOLVO | 655 |
| 963852 | VOLVO | 655 |
| 963853 | VOLVO | 655 |
| 963854 | VOLVO | 656 |
| 963902 | IVECO | 631 |
| 963903 | IVECO | 631 |
| 963904 | IVECO | 677 |
| 963904 | ROR | 721 |
| 964000 | IVECO | 745 |
| 964001 | IVECO | 744 |
| 964002 | IVECO | 745 |
| 964003 | IVECO | 744 |

I riferimenti indicati non sono originali ma perfettamente intercambiabili. I codici originali e le case costruttrici sono indicati a puro titolo informativo
The details described are not original but perfectly interchangeable. The original references and manufacturer names are given for information purposes only.

| Emmerre | Adaptable | Page |
|-----------|-----------|------|
| 964004 | IVECO | 743 |
| 964005 | IVECO | 745 |
| 964006 | IVECO | 746 |
| 964007 | IVECO | 746 |
| 964008 | IVECO | 747 |
| 964009 | IVECO | 745 |
| 964010 | IVECO | 746 |
| 964011 | IVECO | 744 |
| 964013 | IVECO | 742 |
| 964016 | IVECO | 746 |
| 964017 | IVECO | 747 |
| 964022 | FIAT | 737 |
| 964031 | IVECO | 743 |
| 964032 | IVECO | 743 |
| 964033 | IVECO | 744 |
| 964035 | IVECO | 747 |
| 964054 | IVECO | 748 |
| 964055 | IVECO | 748 |
| 964058 | IVECO | 752 |
| 964201 | FORD | 738 |
| 964201 | IVECO | 739 |
| 964202 | FORD | 738 |
| 964202 | IVECO | 739 |
| 964203 | FORD | 738 |
| 964203 | IVECO | 739 |
| 964204 | IVECO | 740 |
| 964205 | IVECO | 740 |
| 964209 | IVECO | 740 |
| 964210 | IVECO | 740 |
| 964211 | IVECO | 739 |
| 964213 | IVECO | 742 |
| 964214 | IVECO | 741 |
| 964215 | DAF | 657 |
| 964215 | IVECO | 669 |
| 964216 | IVECO | 742 |
| 964217 | IVECO | 741 |
| 964218 | IVECO | 669 |
| 964220 | IVECO | 741 |
| 964222 | MERCEDES | 752 |
| 964222 | NISSAN | 753 |
| 964226 | NISSAN | 753 |
| 964234 | IVECO | 742 |
| 964235 | IVECO | 741 |
| 964401 | IVECO | 747 |
| 964402 | IVECO | 748 |
| 964404 | IVECO | 743 |
| 964404 | RENAULT | 754 |
| 965056 | IVECO | 557 |
| 965057 | IVECO | 557 |
| 965058 | IVECO | 584 |
| 965059 | IVECO | 584 |
| 965060 | IVECO | 589 |
| 970006E3 | VOLVO | 454 |
| 970006E11 | VOLVO | 454 |
| 970007E3 | ROR | 444 |
| 970024 | BPW | 385 |
| 970025 | BPW | 385 |
| 970026 | BPW | 385 |
| 970100 | RENAULT | 650 |
| 970101 | IVECO | 638 |
| 970102 | IVECO | 639 |
| 970103 | IVECO | 628 |
| 970104 | IVECO | 628 |
| 970120 | IVECO | 639 |
| 970131 | IVECO | 629 |

| Emmerre | Adaptable | Page |
|---------|-----------|------|
| 970132 | IVECO | 629 |
| 970752 | IVECO | 606 |
| 970801 | DAF | 659 |
| 970801 | IVECO | 691 |
| 970801 | MERCEDES | 698 |
| 970801 | RENAULT | 703 |
| 970801 | SCANIA | 725 |
| 970801 | VOLVO | 729 |
| 970802 | IVECO | 691 |
| 970803 | DAF | 659 |
| 970803 | IVECO | 691 |
| 970803 | MAN | 695 |
| 970803 | MERCEDES | 698 |
| 970803 | RENAULT | 703 |
| 970803 | SCANIA | 725 |
| 970803 | VOLVO | 729 |
| 970804 | DAF | 659 |
| 970804 | IVECO | 692 |
| 970804 | MAN | 695 |
| 970804 | MERCEDES | 698 |
| 970804 | RENAULT | 703 |
| 970804 | SCANIA | 725 |
| 970805 | DAF | 660 |
| 970805 | IVECO | 692 |
| 970805 | MAN | 695 |
| 970805 | MERCEDES | 699 |
| 970805 | RENAULT | 703 |
| 970805 | SCANIA | 725 |
| 970805 | VOLVO | 730 |
| 970806 | DAF | 660 |
| 970806 | IVECO | 692 |
| 970806 | MAN | 696 |
| 970806 | MERCEDES | 699 |
| 970806 | RENAULT | 704 |
| 970806 | SCANIA | 726 |
| 970806 | VOLVO | 730 |
| 970808 | IVECO | 692 |
| 970808 | MAN | 696 |
| 970808 | MERCEDES | 699 |
| 970808 | RENAULT | 704 |
| 970808 | SCANIA | 726 |
| 970808 | VOLVO | 730 |
| 970809 | DAF | 660 |
| 970809 | IVECO | 693 |
| 970809 | MAN | 696 |
| 970809 | MERCEDES | 699 |
| 970809 | VOLVO | 730 |
| 970810 | DAF | 660 |
| 970810 | IVECO | 693 |
| 970810 | MAN | 696 |
| 970810 | MERCEDES | 700 |
| 970810 | RENAULT | 704 |
| 970810 | SCANIA | 726 |
| 970810 | VOLVO | 731 |
| 970811 | DAF | 661 |
| 970811 | IVECO | 693 |
| 970811 | MAN | 697 |
| 970811 | MERCEDES | 700 |
| 970811 | RENAULT | 704 |
| 970811 | SCANIA | 726 |
| 970811 | VOLVO | 731 |
| 970812 | DAF | 661 |
| 970812 | IVECO | 693 |
| 970812 | MERCEDES | 700 |
| 970812 | RENAULT | 705 |

| Emmerre | Adaptable | Page |
|---------|-----------|------|
| 970812 | SCANIA | 727 |
| 971111 | IVECO | 751 |
| 972078 | IVECO | 751 |
| 972079 | IVECO | 750 |
| 972082 | IVECO | 750 |
| 972085 | IVECO | 750 |
| 972093 | IVECO | 750 |
| 972096 | IVECO | 749 |
| 972103 | IVECO | 751 |
| 972104 | IVECO | 748 |
| 972105 | IVECO | 749 |
| 972106 | IVECO | 749 |
| 972107 | IVECO | 749 |
| 975080 | IVECO | 558 |
| 975080 | RENAULT | 578 |
| 975081 | IVECO | 558 |
| 975081 | RENAULT | 578 |
| 975082 | IVECO | 558 |
| 975082 | RENAULT | 578 |
| 975083 | IVECO | 558 |
| 975083 | RENAULT | 578 |
| 975084 | IVECO | 559 |
| 975085 | IVECO | 559 |
| 975086 | IVECO | 563 |
| 975087 | IVECO | 563 |
| 975088 | IVECO | 563 |
| 975089 | IVECO | 563 |
| 975090 | IVECO | 559 |
| 975091 | IVECO | 559 |
| 975092 | IVECO | 560 |
| 975093 | IVECO | 560 |
| 975100 | IVECO | 562 |
| 975101 | IVECO | 562 |
| 975102 | IVECO | 562 |
| 975103 | IVECO | 562 |
| 975104 | IVECO | 561 |
| 975104 | NISSAN | 571 |
| 975105 | IVECO | 561 |
| 975105 | NISSAN | 571 |
| 975106 | IVECO | 561 |
| 975106 | RENAULT | 579 |
| 975107 | IVECO | 561 |
| 975107 | RENAULT | 579 |
| 975108 | IVECO | 566 |
| 975109 | IVECO | 566 |
| 975110 | MERCEDES | 568 |
| 975111 | MERCEDES | 568 |
| 975112 | MERCEDES | 568 |
| 975113 | MERCEDES | 568 |
| 975116 | NISSAN | 574 |
| 975116 | OPEL | 575 |
| 975116 | RENAULT | 579 |
| 975117 | NISSAN | 574 |
| 975117 | OPEL | 574 |
| 975117 | RENAULT | 574 |
| 975119 | IVECO | 560 |
| 975120 | IVECO | 560 |
| 975121 | IVECO | 565 |
| 975122 | IVECO | 565 |
| 975123 | IVECO | 565 |
| 975126 | IVECO | 565 |
| 975128 | IVECO | 567 |
| 975129 | IVECO | 567 |
| 975130 | IVECO | 567 |
| 975131 | IVECO | 567 |

RICERCA DI RIFERIMENTO EMMERRE SEARCH BY EMMERRE'S REFERENCE

| Emmerre | Adaptable | Page |
|-----------|-----------|------|
| 975132 | IVECO | 564 |
| 975133 | IVECO | 564 |
| 975171 | NISSAN | 572 |
| 975171 | RENAULT | 580 |
| 975172 | NISSAN | 572 |
| 975172 | RENAULT | 580 |
| 975190 | MERCEDES | 569 |
| 975191 | MERCEDES | 569 |
| 975192 | MERCEDES | 569 |
| 975193 | MERCEDES | 569 |
| 975200 | IVECO | 564 |
| 975201 | IVECO | 564 |
| 975215 | ISUZU | 556 |
| 975216 | ISUZU | 556 |
| 975230 | FIAT | 554 |
| 975231 | FIAT | 554 |
| 975234 | FIAT | 554 |
| 975235 | FIAT | 554 |
| 975236 | FIAT | 553 |
| 975237 | FIAT | 553 |
| 975238 | FIAT | 553 |
| 975239 | FIAT | 553 |
| 975346 | FORD | 555 |
| 975347 | FORD | 555 |
| 975348 | FORD | 555 |
| 975348 | NISSAN | 571 |
| 975349 | FORD | 555 |
| 975349 | NISSAN | 571 |
| 975350 | NISSAN | 570 |
| 975351 | NISSAN | 570 |
| 975352 | NISSAN | 570 |
| 975353 | NISSAN | 570 |
| 975355 | NISSAN | 573 |
| 975356 | NISSAN | 573 |
| 975357 | NISSAN | 574 |
| 975360 | NISSAN | 572 |
| 975360 | OPEL | 575 |
| 975360 | RENAULT | 577 |
| 975361 | NISSAN | 572 |
| 975361 | OPEL | 575 |
| 975361 | RENAULT | 577 |
| 975362 | NISSAN | 573 |
| 975362 | OPEL | 576 |
| 975362 | RENAULT | 577 |
| 975363 | NISSAN | 573 |
| 975363 | OPEL | 576 |
| 975363 | RENAULT | 577 |
| AC1111 | IVECO | 480 |
| AC1137 | IVECO | 483 |
| AC1137+20 | IVECO | 483 |
| AC1144 | IVECO | 482 |
| AC1144+10 | IVECO | 482 |
| AC1150 | BPW | 463 |
| AC1150 | FRUEHAUF | 472 |
| AC1150 | SAF | 501 |
| AC1150+10 | BPW | 463 |
| AC1150+10 | FRUEHAUF | 472 |
| AC1150+10 | SAF | 501 |
| AC1150+20 | BPW | 463 |
| AC1150+20 | FRUEHAUF | 472 |
| AC1150+20 | SAF | 501 |
| AC1150+30 | BPW | 463 |
| AC1150+30 | FRUEHAUF | 472 |
| AC1150+30 | SAF | 501 |
| AC1394 | BPW | 464 |

| Emmerre | Adaptable | Page |
|-----------|-----------|------|
| AC1394 | COMETTO | 465 |
| AC1394 | FRUEHAUF | 473 |
| AC1394 | SAF | 502 |
| AC1394+10 | BPW | 464 |
| AC1394+10 | COMETTO | 465 |
| AC1394+10 | FRUEHAUF | 473 |
| AC1394+10 | SAF | 502 |
| AC1394+20 | BPW | 464 |
| AC1394+20 | COMETTO | 465 |
| AC1394+20 | FRUEHAUF | 473 |
| AC1394+20 | SAF | 502 |
| AC1394+30 | BPW | 464 |
| AC1394+30 | COMETTO | 465 |
| AC1394+30 | FRUEHAUF | 473 |
| AC1394+30 | SAF | 502 |
| AC1581 | SCANIA | 505 |
| AC1581+10 | SCANIA | 505 |
| AC1581+20 | SCANIA | 505 |
| AC1653 | BPW | 462 |
| AC1653 | COMETTO | 465 |
| AC1653+10 | BPW | 462 |
| AC1653+10 | COMETTO | 465 |
| AC1653+20 | BPW | 462 |
| AC1653+20 | COMETTO | 465 |
| AC1692 | IVECO | 481 |
| AC1692+10 | IVECO | 481 |
| AC1692+20 | IVECO | 481 |
| AC1697 | ASTRA | 457 |
| AC1697+10 | ASTRA | 457 |
| AC1743+20 | IVECO | 484 |
| AC1866 | RENAULT | 494 |
| AC1866+10 | RENAULT | 494 |
| AC1882 | BPW | 463 |
| AC1882 | FRUEHAUF | 470 |
| AC1882+10 | BPW | 463 |
| AC1882+10 | FRUEHAUF | 470 |
| AC1882+20 | BPW | 463 |
| AC1882+20 | FRUEHAUF | 470 |
| AC1899+10 | SCANIA | 506 |
| AC1899+20 | SCANIA | 506 |
| AC1976 | IVECO | 484 |
| AC1976+10 | IVECO | 484 |
| AC1976+20 | IVECO | 484 |
| AC1995 | IVECO | 486 |
| AC1995+10 | IVECO | 486 |
| AC1995+20 | IVECO | 486 |
| AC2103 | IVECO | 479 |
| AC2103+10 | IVECO | 479 |
| AC2103+20 | IVECO | 479 |
| AC2124 | MAN | 490 |
| AC2124 | MERCEDES | 492 |
| AC2124+10 | MAN | 490 |
| AC2124+10 | MERCEDES | 492 |
| AC2124+20 | MAN | 490 |
| AC2124+20 | MERCEDES | 492 |
| AC2125 | MAN | 491 |
| AC2125 | MERCEDES | 493 |
| AC2125 | STEYR | 507 |
| AC2125+10 | MAN | 491 |
| AC2125+10 | MERCEDES | 493 |
| AC2125+10 | STEYR | 507 |
| AC2125+20 | MAN | 491 |
| AC2125+20 | MERCEDES | 493 |
| AC2125+20 | STEYR | 507 |
| AC2126 | MAN | 491 |

| Emmerre | Adaptable | Page |
|-----------|-----------|------|
| AC2126 | MERCEDES | 492 |
| AC2126 | STEYR | 507 |
| AC2126+10 | MAN | 491 |
| AC2126+10 | MERCEDES | 492 |
| AC2126+10 | STEYR | 507 |
| AC2126+20 | MAN | 491 |
| AC2126+20 | MERCEDES | 492 |
| AC2126+20 | STEYR | 507 |
| AC2130 | RENAULT | 495 |
| AC2130+20 | RENAULT | 495 |
| AC2131 | RENAULT | 495 |
| AC2131+10 | RENAULT | 495 |
| AC2131+20 | RENAULT | 495 |
| AC2132 | RENAULT | 496 |
| AC2132+10 | RENAULT | 496 |
| AC2132+20 | RENAULT | 496 |
| AC2133 | SCANIA | 505 |
| AC2133+10 | SCANIA | 505 |
| AC2133+20 | SCANIA | 505 |
| AC2134 | SCANIA | 504 |
| AC2134+10 | SCANIA | 504 |
| AC2134+20 | SCANIA | 504 |
| AC2135 | SCANIA | 504 |
| AC2135+10 | SCANIA | 504 |
| AC2135+20 | SCANIA | 504 |
| AC2137 | VOLVO | 511 |
| AC2137 | YORK | 513 |
| AC2137+10 | VOLVO | 511 |
| AC2137+10 | YORK | 513 |
| AC2137+20 | VOLVO | 511 |
| AC2137+20 | YORK | 513 |
| AC2138 | VOLVO | 512 |
| AC2138+10 | VOLVO | 512 |
| AC2138+20 | VOLVO | 512 |
| AC2139 | YORK | 513 |
| AC2139+10 | VOLVO | 512 |
| AC2139+10 | YORK | 513 |
| AC2139+20 | VOLVO | 512 |
| AC2139+20 | YORK | 513 |
| AC2171 | MAN | 490 |
| AC2171+10 | MAN | 490 |
| AC2171+20 | MAN | 490 |
| AC2199 | STEYR | 508 |
| AC251 | IVECO | 481 |
| AC251+10 | IVECO | 481 |
| AC251+20 | IVECO | 481 |
| AC252 | IVECO | 482 |
| AC261 | IVECO | 485 |
| AC261+10 | IVECO | 485 |
| AC261+20 | IVECO | 485 |
| AS5000 | DAF | 468 |
| AS5000+10 | DAF | 468 |
| AS5000+20 | DAF | 468 |
| AS5001 | DAF | 468 |
| AS5001+10 | DAF | 468 |
| AS5001+20 | DAF | 468 |
| AS5004 | ASTRA | 457 |
| AS5004 | FRUEHAUF | 473 |
| AS5004 | ROR | 500 |
| AS5004+10 | ASTRA | 457 |
| AS5004+10 | FRUEHAUF | 473 |
| AS5004+10 | ROR | 500 |
| AS5004+20 | ASTRA | 457 |
| AS5004+20 | FRUEHAUF | 473 |

I riferimenti indicati non sono originali ma perfettamente intercambiabili. I codici originali e le case costruttrici sono indicati a puro titolo informativo
The details described are not original but perfectly interchangeable. The original references and manufacturer names are given for information purposes only.

| Emmerre | Adaptable | Page |
|-----------|-----------|------|
| AS5004+20 | ROR | 500 |
| AS5005 | DAF | 469 |
| AS5007 | DAF | 469 |
| AS5007+10 | DAF | 469 |
| AS5007+20 | DAF | 469 |
| AS5010 | ASTRA | 459 |
| AS5010 | IVECO | 478 |
| AS5010+10 | ASTRA | 459 |
| AS5010+10 | IVECO | 478 |
| AS5010+20 | ASTRA | 459 |
| AS5010+20 | IVECO | 478 |
| AS5011 | ASTRA | 458 |
| AS5011 | IVECO | 483 |
| AS5011 | VOLVO | 511 |
| AS5011+10 | ASTRA | 458 |
| AS5011+10 | IVECO | 483 |
| AS5011+10 | VOLVO | 511 |
| AS5011+20 | ASTRA | 458 |
| AS5011+20 | IVECO | 483 |
| AS5011+20 | VOLVO | 511 |
| AS5012 | IVECO | 487 |
| AS5012+10 | IVECO | 487 |
| AS5012+20 | IVECO | 487 |
| AS5013+10 | IVECO | 487 |
| AS5013+20 | IVECO | 487 |
| AS5014 | IVECO | 489 |
| AS5014+10 | IVECO | 489 |
| AS5015 | FRUEHAUF | 471 |
| AS5015 | ROR | 498 |
| AS5015 | SMB | 503 |
| AS5015 | TRAILOR | 509 |
| AS5017+10 | IVECO | 479 |
| AS5017+20 | IVECO | 479 |
| AS5018 | IVECO | 477 |
| AS5018+20 | IVECO | 477 |
| AS5021 | IVECO | 480 |
| AS5021 | MERCEDES | 493 |
| AS5021+10 | IVECO | 480 |
| AS5021+10 | MERCEDES | 493 |
| AS5022 | IVECO | 478 |
| AS5023 | IVECO | 476 |
| AS5023+10 | IVECO | 476 |
| AS5024 | ASTRA | 460 |
| AS5024 | IVECO | 477 |
| AS5024+10 | ASTRA | 460 |
| AS5024+10 | IVECO | 477 |
| AS5024+20 | ASTRA | 460 |
| AS5024+20 | IVECO | 477 |
| AS5025 | IVECO | 475 |
| AS5025+20 | IVECO | 475 |
| AS5026 | ASTRA | 458 |
| AS5026 | IVECO | 476 |
| AS5026+10 | ASTRA | 458 |
| AS5026+10 | IVECO | 476 |
| AS5026+20 | ASTRA | 458 |
| AS5026+20 | IVECO | 476 |
| AS5027 | IVECO | 486 |
| AS5027+10 | IVECO | 486 |
| AS5028 | IVECO | 485 |
| AS5028+10 | IVECO | 485 |
| AS5028+20 | IVECO | 485 |
| AS5029 | ASTRA | 461 |
| AS5029 | IVECO | 474 |
| AS5029+10 | ASTRA | 461 |
| AS5029+10 | IVECO | 474 |

| Emmerre | Adaptable | Page |
|-----------|-----------|------|
| AS5029+20 | ASTRA | 461 |
| AS5029+20 | IVECO | 474 |
| AS5031 | ASTRA | 459 |
| AS5031 | IVECO | 475 |
| AS5031+10 | ASTRA | 459 |
| AS5031+10 | IVECO | 475 |
| AS5031+20 | ASTRA | 459 |
| AS5031+20 | IVECO | 475 |
| AS5038 | RENAULT | 494 |
| AS5038+10 | RENAULT | 494 |
| AS5050 | COMETTO | 466 |
| AS5050 | FRUEHAUF | 470 |
| AS5050 | ROR | 498 |
| AS5050 | STEYR | 508 |
| AS5050 | TRAILOR | 509 |
| AS5050+10 | COMETTO | 466 |
| AS5050+10 | FRUEHAUF | 470 |
| AS5050+10 | ROR | 498 |
| AS5050+10 | STEYR | 508 |
| AS5050+10 | TRAILOR | 509 |
| AS5050+20 | COMETTO | 466 |
| AS5050+20 | FRUEHAUF | 470 |
| AS5050+20 | ROR | 498 |
| AS5050+20 | STEYR | 508 |
| AS5050+20 | TRAILOR | 509 |
| AS5050+30 | COMETTO | 466 |
| AS5050+30 | FRUEHAUF | 470 |
| AS5050+30 | ROR | 498 |
| AS5050+30 | STEYR | 508 |
| AS5050+30 | TRAILOR | 509 |
| AS5051 | COMETTO | 467 |
| AS5051 | ROR | 497 |
| AS5051+10 | COMETTO | 467 |
| AS5051+10 | ROR | 497 |
| AS5052 | BPW | 462 |
| AS5052+10 | BPW | 462 |
| AS5052+20 | BPW | 462 |
| AS5054 | IVECO | 488 |
| AS5054+10 | IVECO | 488 |
| AS5055 | IVECO | 488 |
| AS5055+10 | IVECO | 488 |
| AS5055+20 | IVECO | 488 |
| AS5056 | COMETTO | 466 |
| AS5056 | FRUEHAUF | 471 |
| AS5056 | ROR | 499 |
| AS5056 | TRAILOR | 510 |
| AS5056+10 | COMETTO | 466 |
| AS5056+10 | FRUEHAUF | 471 |
| AS5056+10 | ROR | 499 |
| AS5056+10 | TRAILOR | 510 |
| AS5056+20 | COMETTO | 466 |
| AS5056+20 | FRUEHAUF | 471 |
| AS5056+20 | ROR | 499 |
| AS5056+20 | TRAILOR | 510 |
| AS5058 | IVECO | 489 |
| AS5058+10 | IVECO | 489 |
| AS5058+20 | IVECO | 489 |
| AS5061 | SAF | 501 |
| AS5061+10 | SAF | 501 |
| AS5061+20 | SAF | 501 |
| AS5063 | FRUEHAUF | 472 |
| AS5063 | SMB | 503 |
| AS5063 | TRAILOR | 510 |
| AS5063+10 | FRUEHAUF | 472 |
| AS5063+10 | SMB | 503 |

| Emmerre | Adaptable | Page |
|-----------|-----------|------|
| AS5063+10 | TRAILOR | 510 |
| AS5063+20 | FRUEHAUF | 472 |
| AS5063+20 | SMB | 503 |
| AS5063+20 | TRAILOR | 510 |
| AS5068 | ROR | 499 |
| AS5068+10 | ROR | 499 |
| AS5068+20 | ROR | 499 |
| AS5069 | ROR | 497 |
| AS5069+10 | ROR | 497 |
| AS5069+20 | ROR | 497 |
| AS5071 | ASTRA | 460 |
| AS5071 | IVECO | 474 |
| AS5071+10 | ASTRA | 460 |
| AS5071+10 | IVECO | 474 |
| AS5071+20 | ASTRA | 460 |
| AS5071+20 | IVECO | 474 |
| R6000 | | 514 |
| R6001 | | 514 |
| R6002 | | 514 |
| R6003 | | 514 |
| R6004 | | 514 |
| R6005 | | 514 |
| R6006 | | 514 |
| R6007 | | 514 |
| R6008 | | 514 |
| R6009 | | 514 |
| R6010 | | 514 |
| R6018 | | 515 |
| R6100 | | 515 |
| R6101 | | 515 |
| R6102 | | 515 |
| R6103 | | 515 |
| R6104 | | 515 |
| R6105 | | 515 |
| R6106 | | 515 |
| R6107 | | 515 |
| R6108 | | 515 |
| R6109 | | 515 |
| R6200 | | 516 |
| R6201 | | 516 |
| R6202 | | 516 |
| R6203 | | 516 |
| R6204 | | 516 |
| R6205 | | 516 |
| R6206 | | 516 |
| R6207 | | 516 |
| R6300 | | 516 |
| R6301 | | 516 |
| R6302 | | 516 |
| R6303 | | 516 |
| R6304 | | 516 |
| R6400 | | 517 |
| R6401 | | 517 |
| R6402 | | 517 |
| R6403 | | 517 |
| R6405 | | 517 |
| R6500 | | 517 |
| R6501 | | 517 |
| R6502 | | 517 |
| R6503 | | 518 |



DICHIARAZIONE DI ASSICURAZIONE RESPONSABILITA' CIVILE PRODOTTI

Si dichiara che la SpA. **EMMERRE SRL**, con sede legale in 10036 SETTIMO TORNESE (TO) - V. L. Raspin, 2 P.Iva. n. 02110740012 ha stipulato presso la nostra Compagnia una polizza di assicurazione per la Responsabilità Civile Prodotti, il cui premio è stato regolarmente corrisposto e la cui garanzia assicurativa tiene indenne il Contraente, di quanto questi sia tenuto a pagare quale civilmente responsabile ai sensi di legge per danni cagionati a terzi da difetti dei prodotti per i quali riveste, in Italia, la qualità di produttore. E' compresa quindi anche la R.C. derivanti ai sensi del D.P.R. 224/1968 e del D. Lgs. 28/2001.

NUMERO DI POLIZZA: 2018032320152 RC PRODOTTI

MASSIMALI Per Sinistro, Anno assicurativo e Sinistri in lire € 10.000.000.000

VALIDITA' DELLA GARANZIA: Per i prodotti consegnati nei territori di qualsiasi Paese, escluso U.S.A., Canada e Messico, l'assicurazione vale per le richieste di risarcimento presentate al Contraente per la prima volta durante il periodo di efficacia dell'assicurazione stessa. Sono comunque riservati i danni ovunque verificati (compresi U.S.A., Canada e Messico).

It is hereby declared that **EMMERRE SRL**, with registered office in 10036 SETTIMO TORNESE (TO) - V. L. Raspin, 2 P.Iva. n. 02110740012 has stipulated with our Company an insurance policy for the Civil Liability for Products, whose premium has been duly paid and whose insurance guarantee holds the Contractor harmless, of how much he is required to pay as civilly liable under the law for damages caused to third parties by defect of the products for which he holds, in Italy, the title of producer. Therefore, this also includes the civil liability deriving from it pursuant to Presidential Decree 224/1968 and Legislative Decree 28/2001.

POLICY NUMBER: 2018032320152 RC PRODUCTS

MAXIMUM For Claims, Insurance Year and Service Claims € 10,000,000,000

WARRANTY VALIDITY: For products delivered to the territories of any country, excluding the U.S., Canada and Mexico, the insurance applies to claims submitted to the Contractor for the first time during the period of effectiveness of the insurance itself. However, damages wherever they occur (including in the U.S.A., Canada and Mexico) are eligible for compensation.

Reale Mutua Agenzia di Venezia Reale
L'Agente Produttore
Venezia Reale, 17/03/2018

EMMERRE SRL - Via Raspin, 2 - 10036 Settimo Torinese (TO) - Tel. 011-11-400000000 - Fax 011-11-400000000
EMMERRE S.p.A. - Via Raspin, 2 - 10036 Settimo Torinese (TO) - Tel. 011-11-400000000 - Fax 011-11-400000000
EMMERRE S.p.A. - Via Raspin, 2 - 10036 Settimo Torinese (TO) - Tel. 011-11-400000000 - Fax 011-11-400000000



INSURANCE POLICY

CERTIFICATO

Nr. 00 100 6553 - Rev.004

Si attesta che / We do hereby state

A SISTEMA QUALITA' DI
THE QUALITY SYSTEM OF

EMMERRE S.r.l.

È SEDE LEGALE E OPERATIVA
REGISTERED OFFICE AND OPERATIONAL SITE

**VIA RASPIN 2
IT - 10036 SETTIMO TORNESE (TO)**

MAGAZZINO
WAREHOUSE

**VIA VERGA 30
IT - 10036 SETTIMO TORNESE (TO)**

È CONFORME AI REQUISITI COLLABORERÀ
PREMIER POLICY TO COMPANY WITH THE REQUIREMENTS OF

UNI EN ISO 9001:2015

Questo certificato è valido REEL SERVIZIO CLIENTI APPROVARE
This certificate is valid FOR THE FOLLOWING SCOPE

Comercializzazione di ricambi e preparazione kit di ricambi
meccanici per veicoli commerciali, industriali e rimorchi per 20
Trade of spare parts and mechanical kit preparation for vans,
trucks and trailer per 20



Per l'Organismo di Certificazione
For the Certification Body
TUV Italia S.r.l.

Validità / Validity

Del / From 08/19/2017

Al / To 03/04/2018

Andrea Colone
Andrea Colone
Data emissione / Issuing Date
2018-02-01

Prima Certificazione / First Certification 2017-02-01

La validità del presente certificato è subordinata al mantenimento in vigore del Registro Commerciale presso il Tribunale di Settimo Torinese (TO) e all'iscrizione in Camera di Commercio di Settimo Torinese (TO) della società EMMERRE S.p.A. e all'iscrizione in Camera di Commercio di Settimo Torinese (TO) della società EMMERRE S.r.l. e all'iscrizione in Camera di Commercio di Settimo Torinese (TO) della società EMMERRE S.p.A. e all'iscrizione in Camera di Commercio di Settimo Torinese (TO) della società EMMERRE S.r.l.

TUV Italia S.r.l. - Gruppo TÜV SÜD - Via Carcano, 120, P.le. 21 - 20098 Segrate (MI) - Italia - www.tuv.it TÜV®

UNI EN ISO CERTIFICATE

ZERTIFIKAT • CERTIFICATE • 証明書 • СЕРТИФИКАТ

ASSICURAZIONE & CERTIFICATO UNI

POLIZZA ASSICURATIVA "RISCHIO PRODOTTO"
"CIVIL RESPONSIBILITY" INSURANCE POLICY
СТРАХОВОЙ ПОЛИС "РИСК ПРОДУКТА"

EMMERRE

spare parts for trucks and trailers

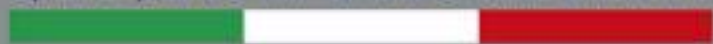

EMMERRE srl

Via Raspini 2 - 10036 Settimo Torinese TO - ITALY

Tel. +39 011 897 7373 - Fax +39 011 897 7953

www.emmerre.eu

info@emmerre.eu
commerciale@emmerre.eu
export@emmerre.eu
sales@emmerre.eu
trade@emmerre.eu